

**DESCRIPTION**

The 536 is a special purpose high performance operational amplifier utilizing an FET input stage for extremely high input impedance and low input current.

The device features internal compensation, standard pinout, wide differential and common mode input voltage range, high slew rate and high output drive capability.

**FEATURES**

- 5pA input bias current
- Input and output protection
- Offset null capability
- Internally compensated
- 6V/μsec slew rate
- Standard pinout
- 1MHz unity gain bandwidth

**PIN CONFIGURATION**

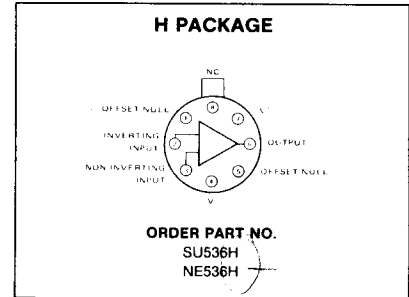

**ABSOLUTE MAXIMUM RATINGS**

PARAMETER	RATING	UNIT
Supply voltage	±22	V
Differential input voltage range	±30	V
Common mode input voltage range	±V <sub>S</sub>	
Power dissipation <sup>1</sup>	500	mW
Operating temperature range		
SU536T	-55 to +85	°C
NE536T	0 to +70	°C
Storage temperature range	-65 to +150	°C
Lead temperature (solder, 60sec)	300	°C
Output short circuit duration <sup>2</sup>	indefinite	

**NOTES**

1. Rating applies for case temperature to +25°C; derate linearly at 6.5mW/°C for ambient temperatures above 75°C.
2. Short circuit may be to ground or either supply. Rating applies to +125°C case temperature or +75°C ambient temperature.

**DC ELECTRICAL CHARACTERISTICS** T<sub>A</sub> = 25°C, V<sub>S</sub> = ±15V unless otherwise specified.<sup>1</sup>

PARAMETER	TEST CONDITIONS	NE536			UNIT
		Min	Typ	Max	
V <sub>OS</sub> Offset voltage	R <sub>S</sub> ≤ 10kΩ		30	90	mV
V <sub>OS</sub> Drift	Over temp., R <sub>S</sub> ≤ 10kΩ R <sub>S</sub> = 0Ω, over temp.		30 30		mV μV/°C
I <sub>OS</sub> Offset current			5		pA
I <sub>BIAS</sub> Input current <sup>2</sup>			30	100	pA
V <sub>CM</sub> Common mode voltage range		±10	±11		V
CMRR Common mode rejection ratio	R <sub>S</sub> ≤ 10kΩ, V <sub>IN</sub> = ±10V	64	80		dB
R <sub>IN</sub> Input resistance			10 <sup>14</sup>		Ω
V <sub>OUT</sub> Output voltage swing	R <sub>L</sub> ≥ 2kΩ, over temp. R <sub>L</sub> 10kΩ, over temp.	±10 ±12	±11 ±13		V V
I <sub>CC</sub> Supply current	V <sub>OUT</sub> = 0V		6.0	8.0	mA
PSRR Supply voltage rejection ratio	R <sub>S</sub> ≤ 10kΩ, ±6 ≤ V <sub>S</sub> ±15		100	300	μV/V
A <sub>VOL</sub> Large signal voltage gain	V <sub>O</sub> = ±10V, R <sub>L</sub> 2kΩ V <sub>O</sub> = ±10V, R <sub>L</sub> ≥ 2kΩ, over temp.	50 25			V/mV V/mV
P <sub>S</sub> Power supply range		±6	±18		V

**NOTES**

1. Operating temperature range: NE536 is 0°C to 70°C.
2. Input current typically doubles every 10°C.

**DC ELECTRICAL CHARACTERISTICS**  $T_A = 25^\circ\text{C}$ ,  $\pm 6\text{V} \leq V_S \leq \pm 20\text{V}$  unless otherwise specified.<sup>2</sup>

PARAMETER	TEST CONDITIONS	SU536			UNIT
		Min	Typ	Max	
$V_{OS}$ Offset voltage	$R_S \leq 10\text{k}\Omega$ $R_S \leq 10\text{k}\Omega$ , over temp.		7.5 7.5	20 30	mV mV
$V_{OS}$ Drift	$R_S \leq 10\text{k}\Omega$		20		$\mu\text{V}/^\circ\text{C}$
$I_{OS}$ Offset current			5		pA
$I_{BIAS}$ Input current <sup>1</sup>	Over temp.		5 250	30 3000	pA pA
$V_{CM}$ Common mode voltage range	$V_S = \pm 15\text{V}$	$\pm 10$	$\pm 11$		V
CMRR Common mode rejection ratio	$R_S \leq 10\text{k}\Omega$ , $V_{IN} = \pm 10\text{V}$	70	80		dB
$R_{IN}$ Input resistance			$10^{14}$		$\Omega$
$V_{OUT}$ Output voltage swing	$R_L \geq 2\text{k}\Omega$ , $V_S = \pm 15\text{V}$ , over temp. $R_L \geq 10\text{k}\Omega$ , $V_S = \pm 15\text{V}$ , over temp.	$\pm 10$ $\pm 12$	$\pm 12$ $\pm 13$		V V
$I_{CC}$ Supply current	$V_{OUT} = 0\text{V}$ , $V_S = \pm 20\text{V}$		6.0	8.0	mA
$P_{SRR}$ Supply voltage rejection ratio	$R_S \leq 10\text{k}\Omega$		50	150	$\mu\text{V}/\text{V}$
$A_{VOL}$ Large signal voltage gain	Over temp., $V_S = \pm 15\text{V}$ , $V_O = \pm 10\text{V}$ , $R_L \geq 2\text{k}\Omega$	50			V/mV
$P_S$ Power supply range		$\pm 6$		$\pm 20$	V

NOTES

1. Input current typically doubles every  $10^\circ\text{C}$ .
2. Operating temperature range for SU536 is  $-55^\circ\text{C}$  to  $+85^\circ\text{C}$ .

**AC ELECTRICAL CHARACTERISTICS**  $T_A = 25^\circ\text{C}$  unless otherwise specified.<sup>1,2</sup>

PARAMETER	TEST CONDITIONS	NE536			SU536			UNIT
		Min	Typ	Max	Min	Typ	Max	
Differential capacitance			6			6		pF
Input noise voltage	0.1Hz — 100kHz		20			20		$\mu\text{V}_{\text{rms}}$
Output impedance			100			100		
Unity gain frequency	$V_S = \pm 15\text{V}$		1			1		MHz
Full power bandwidth	$V_S = \pm 15\text{V}$		100			100		KHz
Slew rate, inverter	$V_S = \pm 15\text{V}$ , $A = -1\text{V}$		6			6		$\text{V}/\mu\text{s}$
Slew rate, follower	$V_S = \pm 15\text{V}$ , $A = +1\text{V}$		6			6		$\text{V}/\mu\text{s}$

NOTES

1. Temperature range for SU536 is  $-55 \leq T_A \leq 85^\circ\text{C}$   
Temperature range for NE536 is  $0^\circ\text{C} \leq T_A \leq 70^\circ\text{C}$
2. SU536 —  $\pm 6\text{V} \leq T_A \leq 20\text{V}$   
NE536 —  $\pm 15\text{V}$

CIRCUIT SCHEMATIC

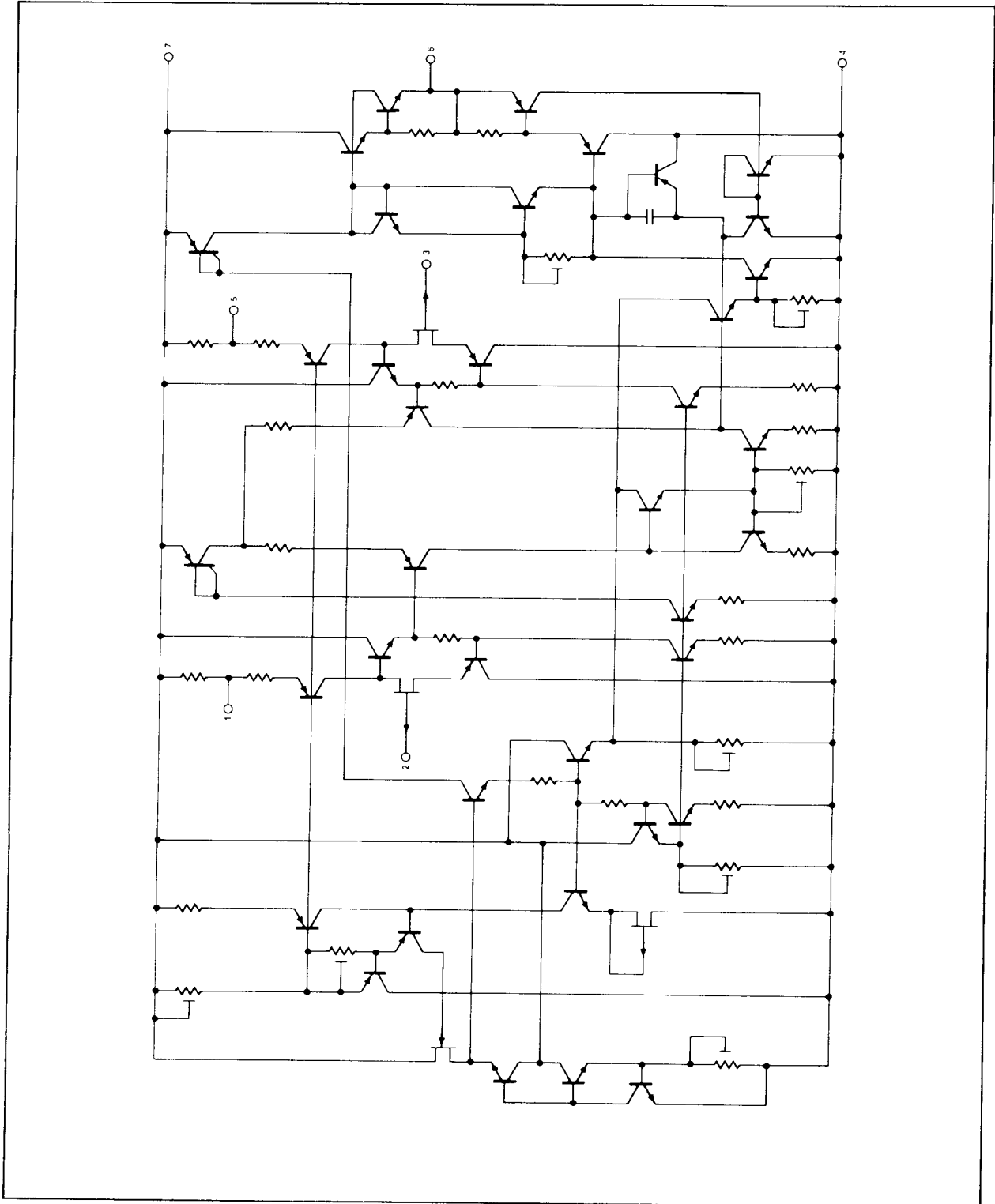

TYPICAL PERFORMANCE CHARACTERISTICS

LARGE SIGNAL VOLTAGE FOLLOWER PULSE RESPONSE

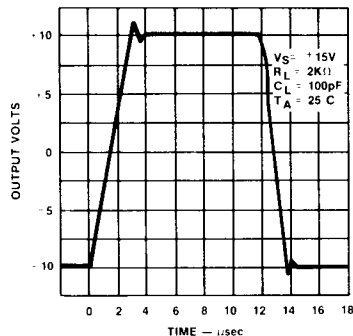

OUTPUT VOLTAGE SWING AS A FUNCTION OF FREQUENCY

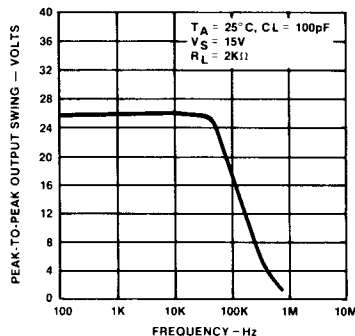

OUTPUT VOLTAGE SWING AS A FUNCTION OF SUPPLY VOLTAGE

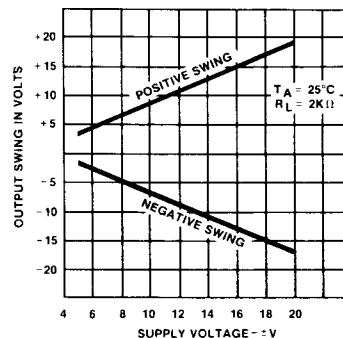

OPEN LOOP PHASE RESPONSE AS A FUNCTION OF FREQUENCY

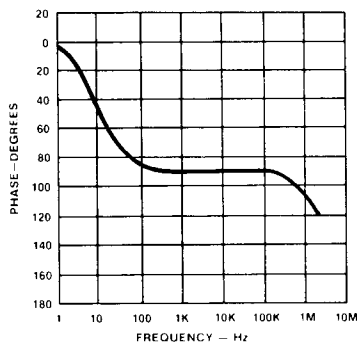

OPEN LOOP VOLTAGE GAIN AS A FUNCTION OF FREQUENCY

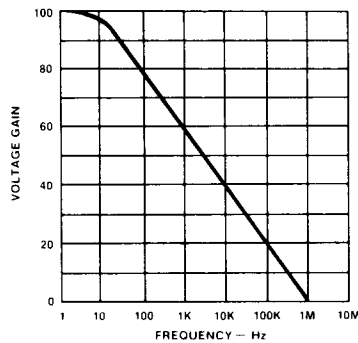

VOLTAGE FOLLOWER TRANSIENT RESPONSE

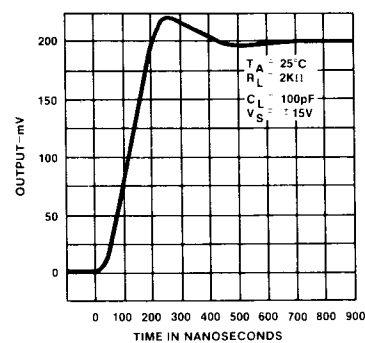

OPEN LOOP VOLTAGE GAIN AS A FUNCTION OF SUPPLY VOLTAGE

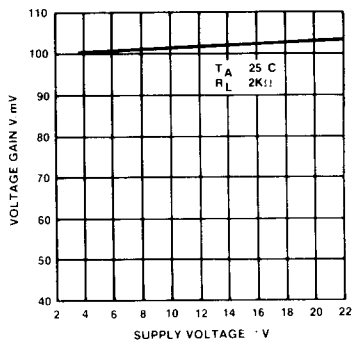

INPUT VOLTAGE NOISE AS A FUNCTION OF FREQUENCY

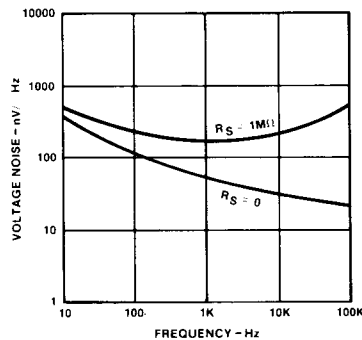

INPUT CURRENTS AS A FUNCTION OF AMBIENT TEMPERATURE

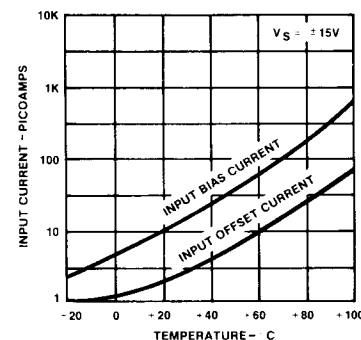

**TYPICAL PERFORMANCE CHARACTERISTICS** (Cont'd)

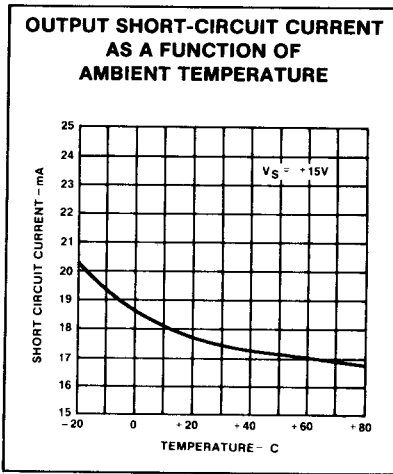

**TEST CIRCUITS**

