

NE5550279A

R09DS0033EJ0100

Rev.1.00

Mar 28, 2012

Silicon Power LDMOS FET

FEATURES

- High Output Power : $P_{out} = 33.0$ dBm TYP. ($V_{DS} = 7.5$ V, $I_{Dset} = 40$ mA, $f = 460$ MHz, $P_{in} = 15$ dBm)
- High power added efficiency : $\eta_{add} = 68\%$ TYP. ($V_{DS} = 7.5$ V, $I_{Dset} = 40$ mA, $f = 460$ MHz, $P_{in} = 15$ dBm)
- High Linear gain : $G_L = 22.5$ dB TYP. ($V_{DS} = 7.5$ V, $I_{Dset} = 40$ mA, $f = 460$ MHz, $P_{in} = 0$ dBm)
- High ESD tolerance
- Suitable for VHF to UHF-BAND Class-AB power amplifier.

APPLICATIONS

- 150 MHz Band Radio System
- 460 MHz Band Radio System
- 900 MHz Band Radio System

ORDERING INFORMATION

Part Number	Order Number	Package	Marking	Supplying Form
NE5550279A	NE5550279A-A	79A (Pb Free)	W7	<ul style="list-style-type: none"> • 12 mm wide embossed taping • Gate pin faces the perforation side of the tape
NE5550279A-T1	NE5550279A-T1-A			<ul style="list-style-type: none"> • 12 mm wide embossed taping • Gate pin faces the perforation side of the tape • Qty 1 kpcs/reel
NE5550279A-T1A	NE5550279A-T1A-A			<ul style="list-style-type: none"> • 12 mm wide embossed taping • Gate pin faces the perforation side of the tape • Qty 5 kpcs/reel

Remark To order evaluation samples, please contact your nearby sales office.

Part number for sample order: NE5550279A

ABSOLUTE MAXIMUM RATINGS ($T_A = 25^\circ\text{C}$, unless otherwise specified)

Operation in excess of any one of these parameters may result in permanent damage.

Parameter	Symbol	Ratings	Unit
Drain to Source Voltage	V_{DS}	30	V
Gate to Source Voltage	V_{GS}	6.0	V
Drain Current	I_{DS}	0.6	A
Drain Current (50% Duty Pulsed)	$I_{DS-pulse}$	1.2	A
Total Power Dissipation ^{Note}	P_{tot}	6.25	W
Channel Temperature	T_{ch}	150	$^\circ\text{C}$
Storage Temperature	T_{stg}	-55 to +150	$^\circ\text{C}$

Note: Value at $T_C = 25^\circ\text{C}$

CAUTION

Observe precautions when handling because these devices are sensitive to electrostatic discharge.

RECOMMENDED OPERATING RANGE (T_A = 25°C)

Parameter	Symbol	Test Conditions	MIN.	TYP.	MAX.	Unit
Drain to Source Voltage	V _{DS}		–	7.5	9.0	V
Gate to Source Voltage	V _{GS}		1.65	2.20	2.85	V
Drain Current	I _{DS}		–	0.4	–	A
Input Power	P _{in}	f = 460 MHz, V _{DS} = 7.5 V	–	15	20	dBm

ELECTRICAL CHARACTERISTICS (T_A = 25°C, unless otherwise specified)

Parameter	Symbol	Test Conditions	MIN.	TYP.	MAX.	Unit
DC Characteristics						
Gate to Source Leakage Current	I _{GSS}	V _{GS} = 6.0 V	–	–	100	nA
Drain to Source Leakage Current (Zero Gate Voltage Drain Current)	I _{DSS}	V _{DS} = 25 V	–	–	10	μA
Gate Threshold Voltage	V _{th}	V _{DS} = 7.5 V, I _{DS} = 1.0 mA	1.15	1.65	2.25	V
Drain to Source Breakdown Voltage	BV _{DSS}	I _{DS} = 10 μA	25	38	–	V
Transconductance	G _m	V _{DS} = 7.5 V, I _{DS} = 100±100 mA	1.8	2.2	2.9	S
Thermal Resistance	R _{th}	Channel to Case	–	20.0	–	°C/W
RF Characteristics						
Output Power	P _{out}	f = 460 MHz, V _{DS} = 7.5 V,	31.5	33.0	–	dBm
Drain Current	I _{DS}	P _{in} = 15 dBm,	–	0.38	–	A
Power Drain Efficiency	η _d	I _{Dset} = 40 mA (RF OFF)	–	70	–	%
Power Added Efficiency	η _{add}		–	68	–	%
Linear Gain	G _L ^{Note}		–	22.5	–	dB

Note: P_{in} = 0 dBm

Remark DC performance is 100% testing. RF performance is testing several samples per wafer.
Wafer rejection criteria for standard devices is 1 reject for several samples.

TEST CIRCUIT SCHEMATIC FOR 460 MHz

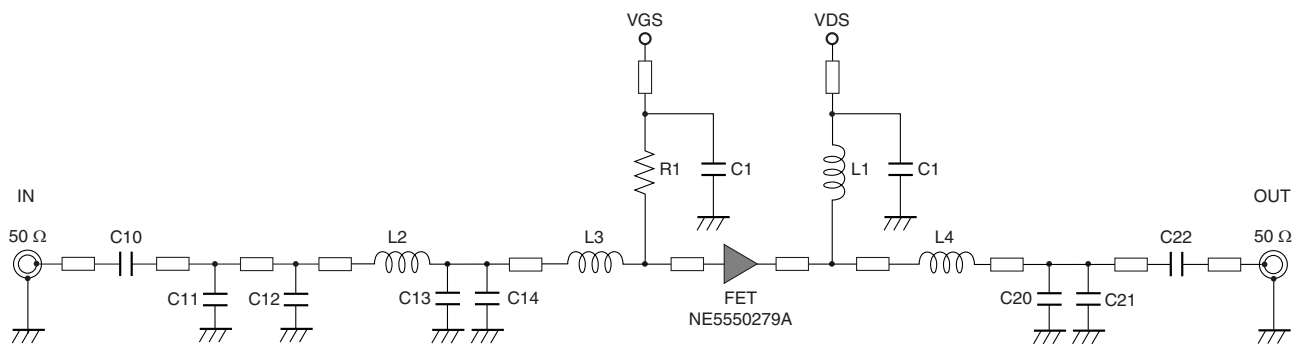

COMPONENTS OF TEST CIRCUIT FOR MEASURING ELECTRICAL CHARACTERISTICS

Symbol	Value	Type	Maker
C1	1 μ F	GRM188B31C105KA92	Murata
C10	22 pF	GRM1882C1H220JA01	Murata
C11	1.2 pF	ATC100A1R2JW	American Technical Ceramics
C12	4.7 pF	ATC100A4R7BW	American Technical Ceramics
C13	15 pF	ATC100A150BW	American Technical Ceramics
C14	12 pF	ATC100A120BW	American Technical Ceramics
C20	10 pF	ATC100A100JW	American Technical Ceramics
C21	3.9 pF	ATC100A3R9BW	American Technical Ceramics
C22	100 pF	ATC100A101JW	American Technical Ceramics
R1	2 k Ω	1/10 W Chip Resistor RK73B1JT2D202J	KOA
L1	123 nH	ϕ 0.5 mm, ϕ D = 3 mm, 10 Turns	Ohesangyou
L2	10 nH	LQW18AN10NG00	Murata
L3	9.8 nH	ϕ 0.4 mm, ϕ D = 1.6 mm, 3 Turns	Ohesangyou
L4	20 nH	ϕ 0.5 mm, ϕ D = 3 mm, 2 Turns	Ohesangyou
PCB	-	R4775, t = 0.4 mm, ϵ r = 4.5, size = 30 \times 48 mm	Panasonic
SMA Connector	-	WAKA 01K0790-20	WAKA

COMPONENT LAYOUT OF TEST CIRCUIT FOR 460 MHz

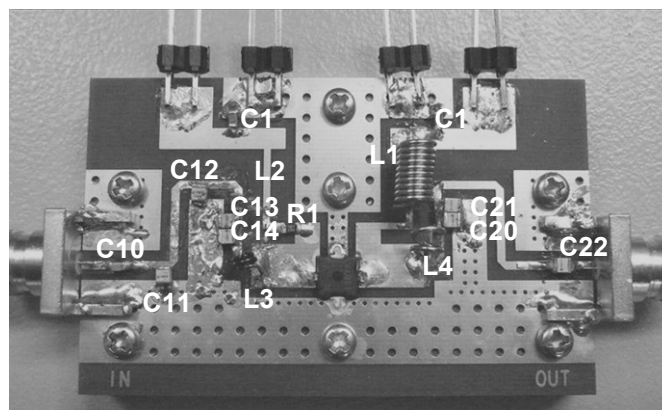

TYPICAL CHARACTERISTICS 1 (T_A = 25°C)

R: f = 460 MHz, V_{DS} = 3.6/4.5/6/7.5/9 V, I_{Dset} = 40 mA, P_{in} = -10 to 20 dBm

IM: f1 = 460 MHz, f2 = 461 MHz, V_{DS} = 3.6/4.5/6/7.5/9 V, I_{Dset} = 40 mA, P_{out} (2 tone) = 8 to 32 dBm

OUTPUT POWER, DRAIN CURRENT vs. INPUT POWER

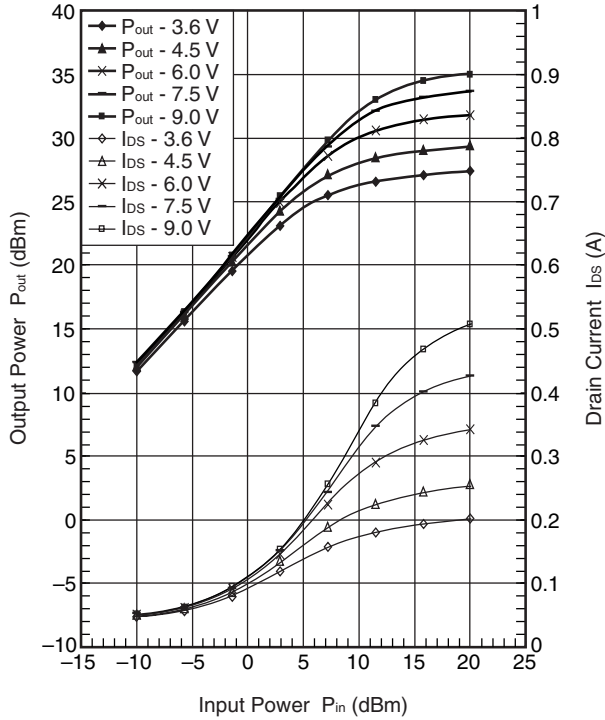

POWER GAIN, POWER ADDED EFFICIENCY vs. INPUT POWER

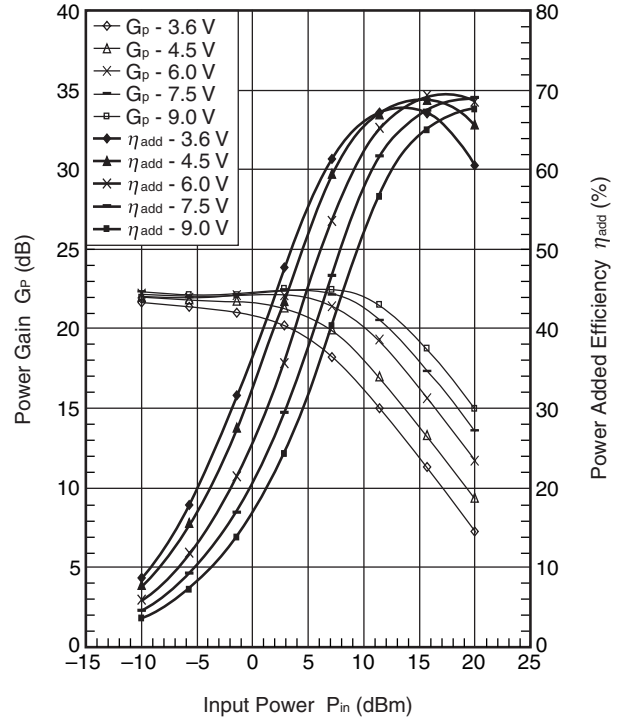

2f₀, 3f₀ vs. OUTPUT POWER

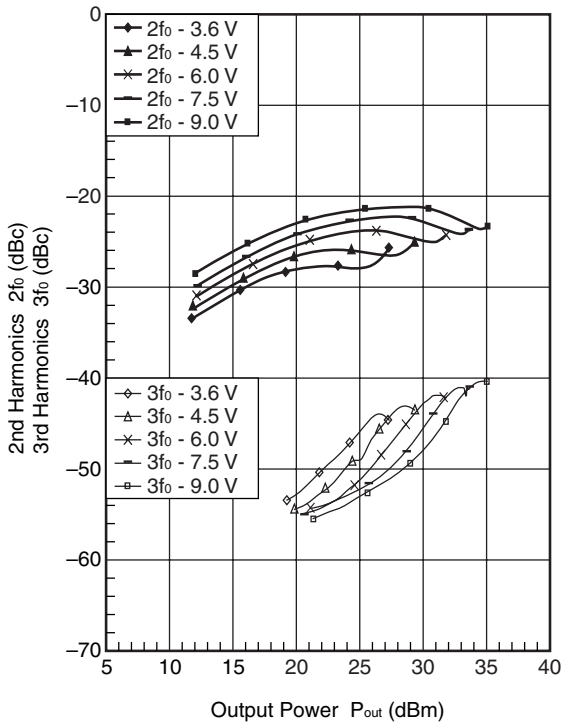

IM₃/IM₅ vs. 2 TONES OUTPUT POWER

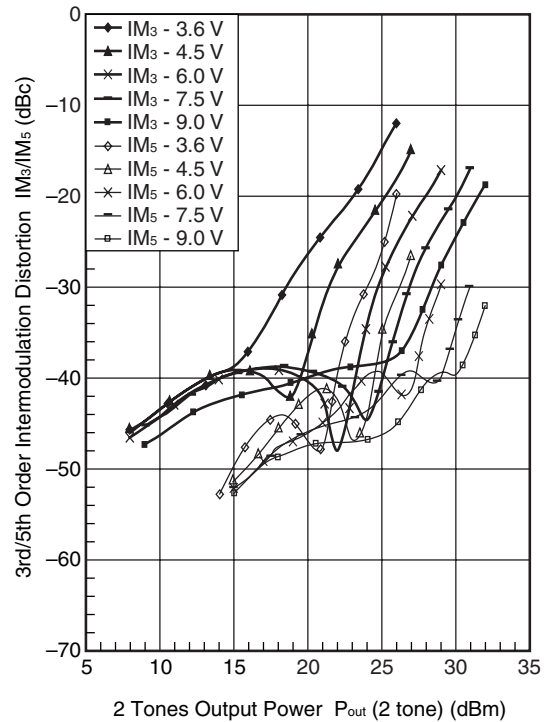

Remark The graphs indicate nominal characteristics.

S-PARAMETERS

S-parameters and noise parameters are provided on our Web site in a format (S2P) that enables the direct import of the parameters to microwave circuit simulators without the need for keyboard inputs.

Click here to download S-parameters.

[RF Devices] → [Design Support] → [Development Data Download]

URL <http://www.renesas.com/products/microwave/download/index.jsp>

PACKAGE DIMENSIONS

79A (UNIT: mm)

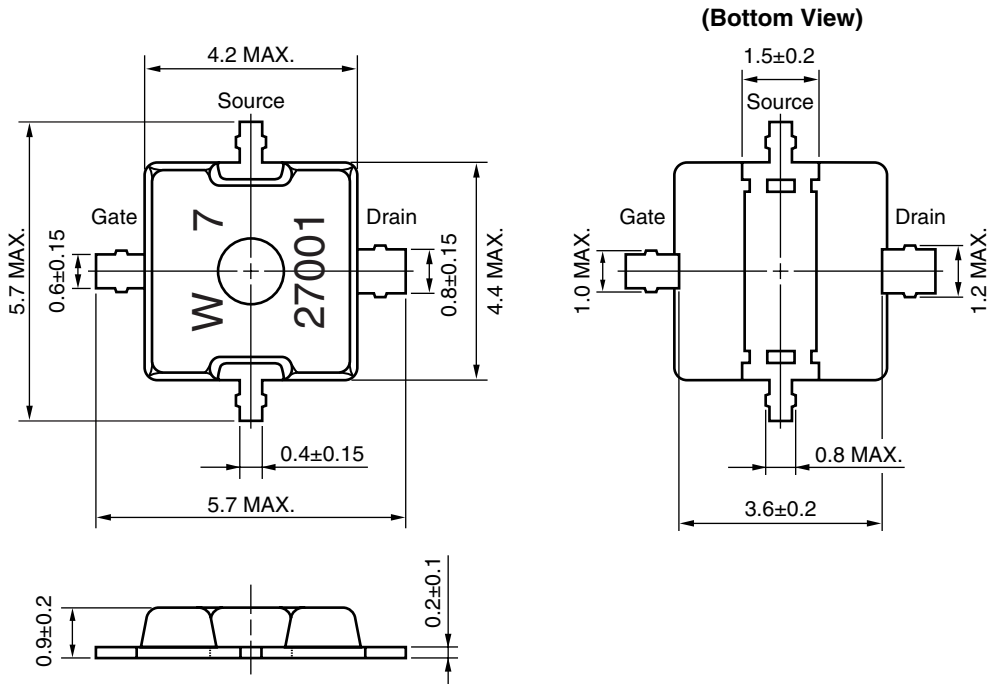

79A PACKAGE RECOMMENDED P.C.B. LAYOUT (UNIT: mm)

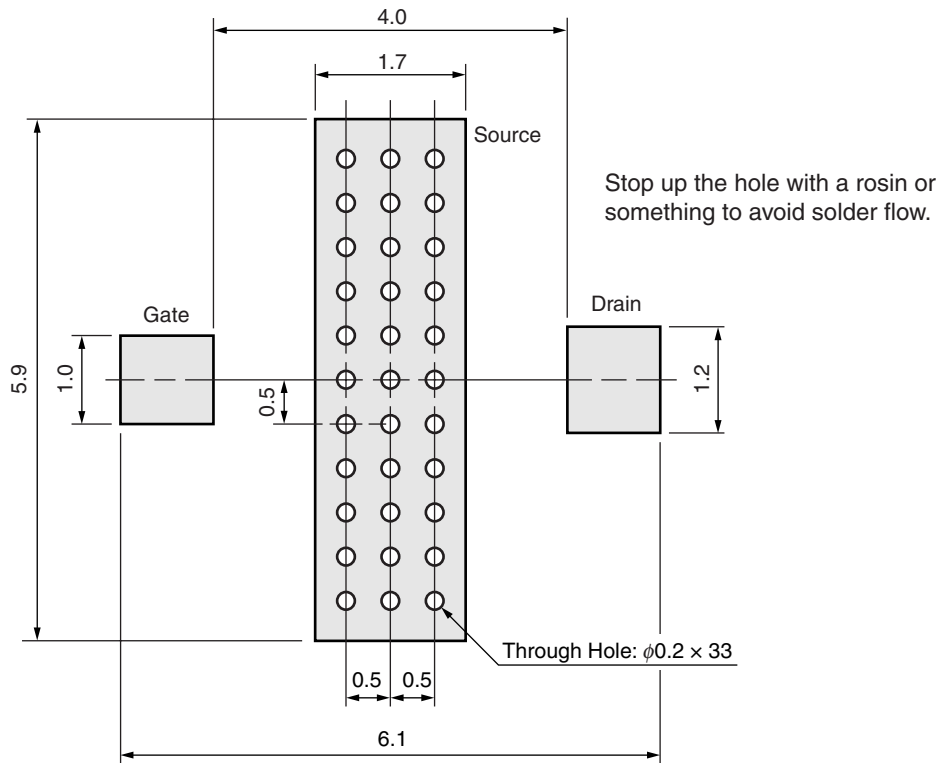

Revision History	NE5550279A Data Sheet
-------------------------	------------------------------

Rev.	Date	Description	
		Page	Summary
1.00	Mar 28, 2012	-	First edition issued

All trademarks and registered trademarks are the property of their respective owners.

Notice

- All information included in this document is current as of the date this document is issued. Such information, however, is subject to change without any prior notice. Before purchasing or using any Renesas Electronics products listed herein, please confirm the latest product information with a Renesas Electronics sales office. Also, please pay regular and careful attention to additional and different information to be disclosed by Renesas Electronics such as that disclosed through our website.
 - Renesas Electronics does not assume any liability for infringement of patents, copyrights, or other intellectual property rights of third parties by or arising from the use of Renesas Electronics products or technical information described in this document. No license, express, implied or otherwise, is granted hereby under any patents, copyrights or other intellectual property rights of Renesas Electronics or others.
 - You should not alter, modify, copy, or otherwise misappropriate any Renesas Electronics product, whether in whole or in part.
 - Descriptions of circuits, software and other related information in this document are provided only to illustrate the operation of semiconductor products and application examples. You are fully responsible for the incorporation of these circuits, software, and information in the design of your equipment. Renesas Electronics assumes no responsibility for any losses incurred by you or third parties arising from the use of these circuits, software, or information.
 - When exporting the products or technology described in this document, you should comply with the applicable export control laws and regulations and follow the procedures required by such laws and regulations. You should not use Renesas Electronics products or the technology described in this document for any purpose relating to military applications or use by the military, including but not limited to the development of weapons of mass destruction. Renesas Electronics products and technology may not be used for or incorporated into any products or systems whose manufacture, use, or sale is prohibited under any applicable domestic or foreign laws or regulations.
 - Renesas Electronics has used reasonable care in preparing the information included in this document, but Renesas Electronics does not warrant that such information is error free. Renesas Electronics assumes no liability whatsoever for any damages incurred by you resulting from errors in or omissions from the information included herein.
 - Renesas Electronics products are classified according to the following three quality grades: "Standard", "High Quality", and "Specific". The recommended applications for each Renesas Electronics product depends on the product's quality grade, as indicated below. You must check the quality grade of each Renesas Electronics product before using it in a particular application. You may not use any Renesas Electronics product for any application categorized as "Specific" without the prior written consent of Renesas Electronics. Further, you may not use any Renesas Electronics product for any application for which it is not intended without the prior written consent of Renesas Electronics. Renesas Electronics shall not be in any way liable for any damages or losses incurred by you or third parties arising from the use of any Renesas Electronics product for an application categorized as "Specific" or for which the product is not intended where you have failed to obtain the prior written consent of Renesas Electronics. The quality grade of each Renesas Electronics product is "Standard" unless otherwise expressly specified in a Renesas Electronics data sheets or data books, etc.
"Standard": Computers; office equipment; communications equipment; test and measurement equipment; audio and visual equipment; home electronic appliances; machine tools; personal electronic equipment; and industrial robots.
"High Quality": Transportation equipment (automobiles, trains, ships, etc.); traffic control systems; anti-disaster systems; anti-crime systems; safety equipment; and medical equipment not specifically designed for life support.
"Specific": Aircraft; aerospace equipment; submersible repeaters; nuclear reactor control systems; medical equipment or systems for life support (e.g. artificial life support devices or systems), surgical implantations, or healthcare intervention (e.g. excision, etc.), and any other applications or purposes that pose a direct threat to human life.
 - You should use the Renesas Electronics products described in this document within the range specified by Renesas Electronics, especially with respect to the maximum rating, operating supply voltage range, movement power voltage range, heat radiation characteristics, installation and other product characteristics. Renesas Electronics shall have no liability for malfunctions or damages arising out of the use of Renesas Electronics products beyond such specified ranges.
 - Although Renesas Electronics endeavors to improve the quality and reliability of its products, semiconductor products have specific characteristics such as the occurrence of failure at a certain rate and malfunctions under certain use conditions. Further, Renesas Electronics products are not subject to radiation resistance design. Please be sure to implement safety measures to guard them against the possibility of physical injury, and injury or damage caused by fire in the event of the failure of a Renesas Electronics product, such as safety design for hardware and software including but not limited to redundancy, fire control and malfunction prevention, appropriate treatment for aging degradation or any other appropriate measures. Because the evaluation of microcomputer software alone is very difficult, please evaluate the safety of the final products or system manufactured by you.
 - Please contact a Renesas Electronics sales office for details as to environmental matters such as the environmental compatibility of each Renesas Electronics product. Please use Renesas Electronics products in compliance with all applicable laws and regulations that regulate the inclusion or use of controlled substances, including without limitation, the EU RoHS Directive. Renesas Electronics assumes no liability for damages or losses occurring as a result of your noncompliance with applicable laws and regulations.
 - This document may not be reproduced or duplicated, in any form, in whole or in part, without prior written consent of Renesas Electronics.
 - Please contact a Renesas Electronics sales office if you have any questions regarding the information contained in this document or Renesas Electronics products, or if you have any other inquiries.
- (Note 1) "Renesas Electronics" as used in this document means Renesas Electronics Corporation and also includes its majority-owned subsidiaries.
(Note 2) "Renesas Electronics product(s)" means any product developed or manufactured by or for Renesas Electronics.



SALES OFFICES

Renesas Electronics Corporation

<http://www.renesas.com>

Refer to "<http://www.renesas.com/>" for the latest and detailed information.

Renesas Electronics America Inc.
2880 Scott Boulevard Santa Clara, CA 95050-2554, U.S.A.
Tel: +1-408-586-6000, Fax: +1-408-586-6130

Renesas Electronics Canada Limited
1101 Nicholson Road, Newmarket, Ontario L3Y 9C3, Canada
Tel: +1-905-898-5441, Fax: +1-905-898-3220

Renesas Electronics Europe Limited
Dukes Meadow, Millboard Road, Bourne End, Buckinghamshire, SL8 5FH, U.K.
Tel: +44-1628-585-100, Fax: +44-1628-585-900

Renesas Electronics Europe GmbH
Arcadiastrasse 10, 40472 Düsseldorf, Germany
Tel: +49-211-65030, Fax: +49-211-6503-1327

Renesas Electronics (China) Co., Ltd.
7th Floor, Quantum Plaza, No.27 ZhiChunLu Haidian District, Beijing 100083, P.R.China
Tel: +86-10-8235-1155, Fax: +86-10-8235-7679

Renesas Electronics (Shanghai) Co., Ltd.
Unit 204, 205, AZIA Center, No.1233 Lujiazui Ring Rd., Pudong District, Shanghai 200120, China
Tel: +86-21-5877-1818, Fax: +86-21-6887-7858 / -7898

Renesas Electronics Hong Kong Limited
Unit 1601-1613, 16/F., Tower 2, Grand Century Place, 193 Prince Edward Road West, Mongkok, Kowloon, Hong Kong
Tel: +852-2886-9318, Fax: +852 2886-9022/9044

Renesas Electronics Taiwan Co., Ltd.
13F, No. 363, Fu Shing North Road, Taipei, Taiwan
Tel: +886-2-8175-9600, Fax: +886 2-8175-9670

Renesas Electronics Singapore Pte. Ltd.
1 HarbourFront Avenue, #06-10, Keppel Bay Tower, Singapore 098632
Tel: +65-6213-0200, Fax: +65-6276-8001

Renesas Electronics Malaysia Sdn.Bhd.
Unit 906, Block B, Menara Amcorp, Amcorp Trade Centre, No. 18, Jin Persiaran Barat, 46050 Petaling Jaya, Selangor Darul Ehsan, Malaysia
Tel: +60-3-7955-9390, Fax: +60-3-7955-9510

Renesas Electronics Korea Co., Ltd.
11F., Samik Lavied' or Bldg., 720-2 Yeoksam-Dong, Kangnam-Ku, Seoul 135-080, Korea
Tel: +82-2-558-3737, Fax: +82-2-558-5141