

NEC

NPN EPITAXIAL SILICON TRANSISTOR FOR MICROWAVE HIGH-GAIN AMPLIFICATION

NE699M01**FEATURES**

- **HIGH f_T :**
16 GHz TYP at 2 V, 20 mA
- **LOW NOISE FIGURE:**
NF = 1.1 dB TYP at 2 GHz
- **HIGH GAIN:**
 $|S_{21E}|^2 = 14$ dB TYP at $f = 2$ GHz
- **6 PIN SMALL MINI MOLD PACKAGE**
- **EXCELLENT LOW VOLTAGE,
LOW CURRENT PERFORMANCE**

DESCRIPTION

The NE699M01 is an NPN high frequency silicon epitaxial transistor (NE687) encapsulated in an ultra small 6 pin SOT-363 package. Its four emitter pins decrease emitter inductance resulting in 3 dB more gain compared to conventional SOT-23 and SOT-143 devices. The NE699M01 is ideal for LNA and pre-driver applications up to 2.4 GHz where low cost, high gain, low voltage and low current are prime considerations.

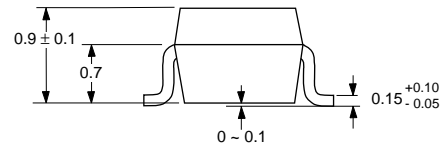
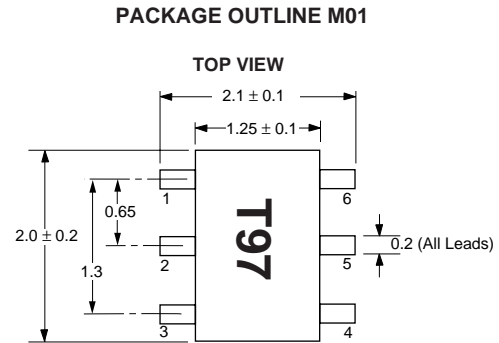
OUTLINE DIMENSIONS (Units in mm)**PIN CONNECTIONS**

- | | |
|------------|--------------|
| 1. Emitter | 4. Emitter |
| 2. Emitter | 5. Emitter |
| 3. Base | 6. Collector |

Note: Pin 3 is identified with a circle on the bottom of the package.

ELECTRICAL CHARACTERISTICS ($T_A = 25^\circ\text{C}$)

PART NUMBER PACKAGE OUTLINE			NE699M01 M01		
SYMBOLS	PARAMETERS AND CONDITIONS	UNITS	MIN	TYP	MAX
I_{CBO}	Collector Cutoff Current at $V_{CB} = 5$ V, $I_E = 0$	μA			0.1
I_{EBO}	Emitter Cutoff Current at $V_{EB} = 1$ V, $I_C = 0$	μA			0.1
h_{FE}^1	DC Current Gain at $V_{CE} = 2$ V, $I_C = 20$ mA		70		140
f_T	Gain Bandwidth Product at $V_{CE} = 2$ V, $I_C = 20$ mA, $f = 2.0$ GHz	GHz	13	16	
C_{RE}^2	Feedback Capacitance at $V_{CB} = 2$ V, $I_E = 0$, $f = 1$ MHz	pF		0.2	0.3
$ S_{21E} ^2$	Insertion Power Gain at $V_{CE} = 2$ V, $I_C = 20$ mA, $f = 2.0$ GHz	dB	12	14	
NF	Noise Figure at $V_{CE} = 2$ V, $I_C = 3$ mA, $f = 2.0$ GHz	dB		1.1	1.8

Notes:

1. Pulsed measurement, pulse width ≤ 350 μs , duty cycle $\leq 2\%$.
2. The emitter terminal should be connected to the ground terminal of the 3 terminal capacitance bridge.

ABSOLUTE MAXIMUM RATINGS¹ (T_A = 25°C)

SYMBOLS	PARAMETERS	UNITS	RATINGS
V _{CB0}	Collector to Base Voltage	V	5
V _{CE0}	Collector to Emitter Voltage	V	3
V _{EB0}	Emitter to Base Voltage	V	2
I _C	Collector Current	mA	30
P _T	Total Power Dissipation	mW	90
T _J	Junction Temperature	°C	150
T _{STG}	Storage Temperature	°C	-65 to +150

Notes:

1. Operation in excess of any one of these parameters may result in permanent damage.

ORDERING INFORMATION

PART NUMBER	QUANTITY	PACKAGING
NE699M01-T1	3000	Tape & Reel

TYPICAL PERFORMANCE CURVES (T_A = 25°C)

TOTAL POWER DISSIPATION vs. AMBIENT TEMPERATURE

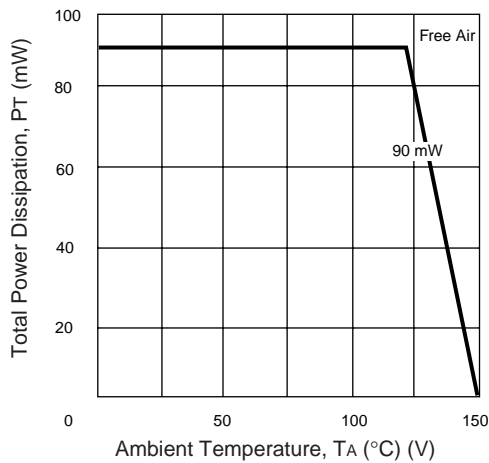

COLLECTOR CURRENT vs. BASE TO EMITTER VOLTAGE

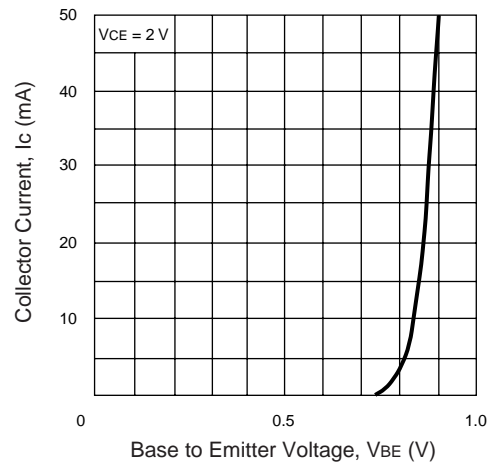

COLLECTOR CURRENT vs. COLLECTOR TO EMITTER VOLTAGE

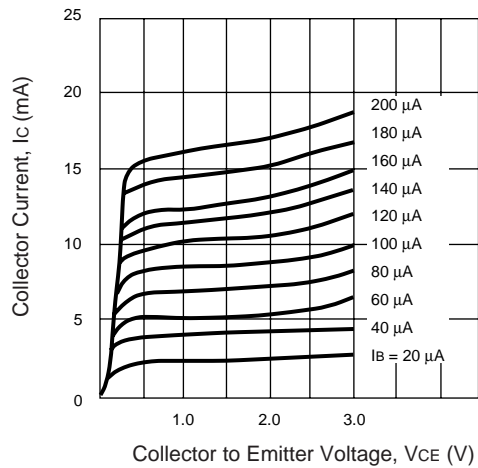

DC CURRENT GAIN vs. COLLECTOR CURRENT

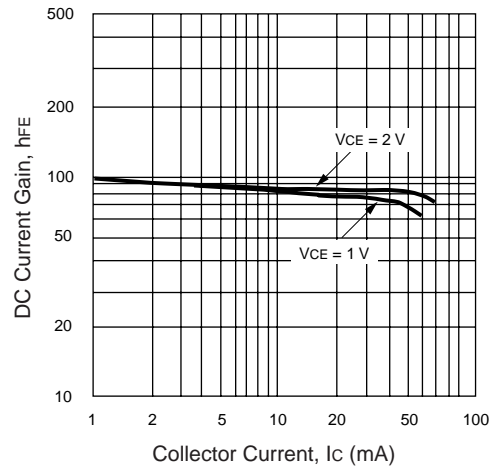

TYPICAL PERFORMANCE CURVES (TA = 25°C)

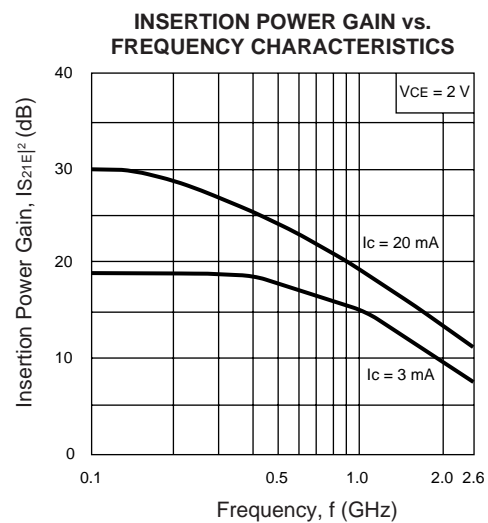
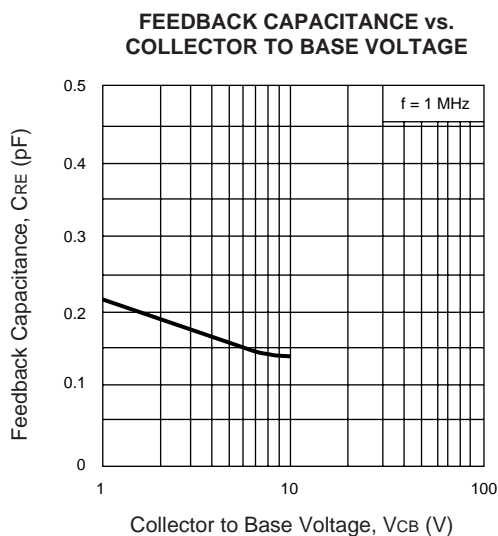
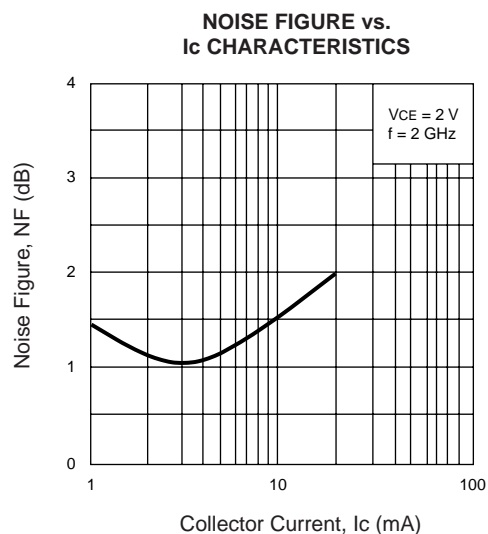
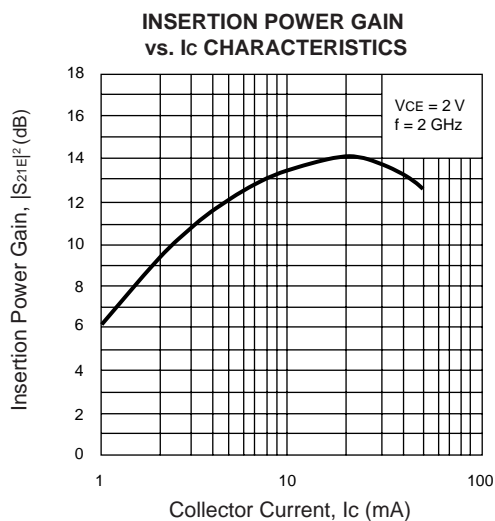
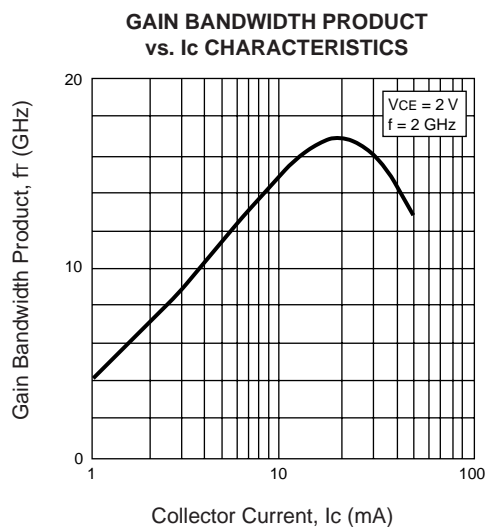

TYPICAL NOISE PARAMETERS ($T_A = 25^\circ\text{C}$)

FREQ. (MHz)	NF _{OPT} (dB)	G _A (dB)	Γ _{OPT}		R _n /50
			MAG	ANG	
V_{CE} = 2 V, I_C = 7 mA					
0.50	1.25	23.0	0.40	27	0.25
1.00	1.35	19.7	0.32	50	0.34
1.50	1.46	17.0	0.27	70	0.22
2.00	1.55	14.3	0.22	93	0.21
2.50	1.70	12.0	0.18	130	0.17
3.00	1.86	9.8	0.17	160	0.12
4.00	2.30	9.2	0.30	-150	0.08
5.00	2.75	8.2	0.60	-111	0.28

TYPICAL CONSTANT NOISE FIGURE

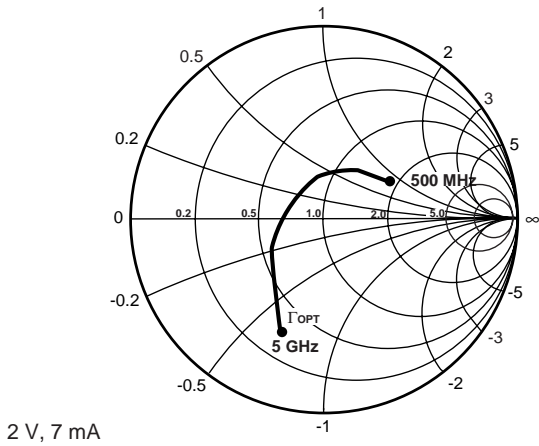

MINIMUM NOISE FIGURE vs. FREQUENCY

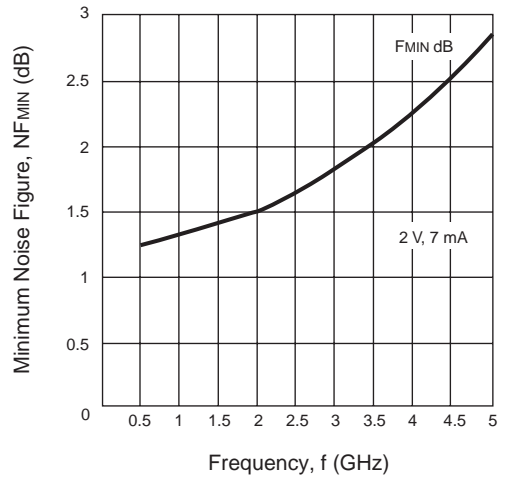

TYPICAL SCATTERING PARAMETERS (TA = 25°C)

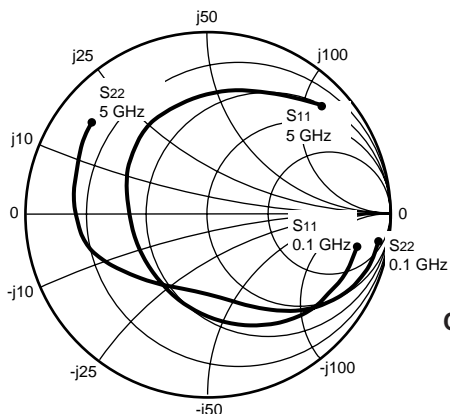

Coordinates in Ohms
Frequency in GHz
VCE = 2 V, IC = 5 mA

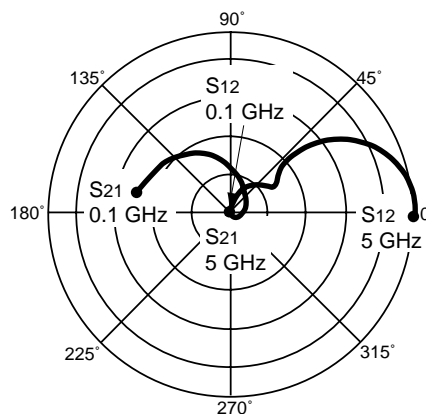

NE699M01
VCE = 2 V, IC = 1 mA

FREQUENCY (GHz)	S11		S21		S12		S22		K	MAG ¹ (dB)
	MAG	ANG	MAG	ANG	MAG	ANG	MAG	ANG		
0.100	0.965	-5.8	3.118	169.3	0.013	82.4	0.990	-4.4	0.17	23.8
0.250	0.957	-16.5	2.957	164.0	0.031	76.7	0.985	-10.5	0.10	19.8
0.400	0.939	-26.7	2.971	155.1	0.049	69.3	0.972	-16.8	0.13	17.8
0.600	0.903	-40.4	2.934	143.5	0.070	59.7	0.947	-24.9	0.17	16.2
0.800	0.856	-54.6	2.871	132.0	0.088	50.0	0.917	-32.8	0.22	15.1
1.000	0.806	-68.8	2.754	120.8	0.102	40.9	0.881	-40.3	0.27	14.3
1.200	0.754	-83.5	2.648	109.7	0.112	32.3	0.844	-47.4	0.33	13.7
1.400	0.708	-98.0	2.503	99.4	0.118	24.3	0.809	-54.0	0.38	13.3
1.600	0.672	-111.7	2.334	89.6	0.119	17.0	0.778	-60.4	0.45	12.9
1.800	0.642	-125.3	2.196	80.6	0.118	10.6	0.752	-66.6	0.51	12.7
2.000	0.623	-137.6	2.045	71.9	0.114	5.1	0.732	-72.7	0.59	12.6
2.500	0.619	-162.8	1.687	53.0	0.095	-4.3	0.706	-87.7	0.83	12.5
3.000	0.637	178.8	1.410	37.3	0.073	-5.0	0.708	-102.9	1.17	10.4
3.500	0.661	164.5	1.179	23.6	0.056	9.0	0.728	-117.2	1.58	8.8
4.000	0.685	152.0	1.000	11.8	0.058	34.6	0.753	-130.2	1.55	8.0
4.500	0.705	139.7	0.851	1.7	0.079	49.5	0.780	-141.1	1.16	7.9
5.000	0.721	126.6	0.735	-7.0	0.109	52.3	0.804	-150.0	0.89	8.3

VCE = 2 V, IC = 5 mA

FREQUENCY (GHz)	S11		S21		S12		S22		K	MAG ¹ (dB)
	MAG	ANG	MAG	ANG	MAG	ANG	MAG	ANG		
0.100	0.844	-11.8	13.310	166.4	0.012	79.5	0.955	-8.7	0.21	30.4
2.500	0.467	162.3	3.441	50.7	0.075	33.4	0.423	-100.4	0.19	26.4
0.400	0.735	-49.7	11.439	140.3	0.041	60.0	0.847	-31.2	0.25	24.5
0.600	0.634	-72.3	10.168	124.9	0.053	49.9	0.751	-42.8	0.35	22.8
0.800	0.546	-93.2	8.857	112.0	0.061	42.4	0.665	-52.0	0.45	21.7
1.000	0.482	-112.5	7.697	101.2	0.065	37.2	0.596	-59.3	0.56	20.7
1.200	0.442	-130.3	6.735	91.9	0.068	33.7	0.541	-65.6	0.66	20.0
1.400	0.422	-146.3	5.939	83.9	0.069	31.6	0.501	-71.3	0.77	19.3
1.600	0.416	-159.8	5.277	76.8	0.070	30.4	0.471	-76.6	0.87	18.8
1.800	0.419	-171.6	4.746	70.2	0.071	30.2	0.450	-81.9	0.96	18.3
2.000	0.429	179.0	4.288	64.2	0.072	30.6	0.436	-87.1	1.04	16.5
2.500	0.467	162.3	3.441	50.7	0.075	33.4	0.423	-100.4	1.19	14.0
3.000	0.503	151.4	2.860	38.7	0.081	37.6	0.435	-113.5	1.24	12.5
3.500	0.534	142.8	2.433	27.7	0.092	41.2	0.465	-125.3	1.21	11.5
4.000	0.560	134.8	2.108	17.3	0.106	43.1	0.503	-135.6	1.12	10.9
4.450	0.716	-55.4	11.128	136.4	0.045	57.4	0.826	-34.4	1.02	10.9
5.000	0.602	115.7	1.636	-2.0	0.143	41.5	0.588	-150.7	0.91	10.6

Note:
1. Gain Calculation:

$$MAG = \frac{|S_{21}|}{|S_{12}|} \left(K \pm \sqrt{K^2 - 1} \right). \text{ When } K \leq 1, \text{ MAG is undefined and MSG values are used. } MSG = \frac{|S_{21}|}{|S_{12}|}, K = \frac{1 + |\Delta|^2 - |S_{11}|^2 - |S_{22}|^2}{2 |S_{12} S_{21}|}, \Delta = S_{11} S_{22} - S_{21} S_{12}$$

MAG = Maximum Available Gain
MSG = Maximum Stable Gain

TYPICAL SCATTERING PARAMETERS (T_A = 25°C)

NE699M01

V_{CE} = 2 V, I_c = 7 mA

FREQUENCY (GHz)	S ₁₁		S ₂₁		S ₁₂		S ₂₂		K	MAG ¹ (dB)
	MAG	ANG	MAG	ANG	MAG	ANG	MAG	ANG		
0.100	0.792	-14.7	17.256	164.9	0.012	78.8	0.939	-10.3	0.23	31.6
0.250	0.743	-37.2	15.479	149.9	0.027	67.6	0.882	-24.0	0.23	27.6
0.400	0.658	-58.5	14.101	135.4	0.038	57.9	0.794	-35.7	0.31	25.7
0.600	0.552	-83.5	12.010	119.6	0.048	48.8	0.683	-47.5	0.43	24.0
0.800	0.471	-105.7	10.130	107.1	0.054	43.0	0.593	-56.4	0.55	22.8
1.000	0.421	-125.7	8.616	97.0	0.058	39.5	0.525	-63.4	0.67	21.7
1.200	0.397	-143.6	7.432	88.4	0.061	37.5	0.476	-69.4	0.77	20.9
1.400	0.389	-158.8	6.493	81.0	0.063	36.7	0.440	-74.9	0.87	20.1
1.600	0.393	-171.3	5.738	74.5	0.065	36.5	0.415	-80.1	0.96	19.5
1.800	0.403	178.2	5.137	68.4	0.067	37.0	0.397	-85.5	1.04	17.6
2.000	0.418	170.0	4.634	62.8	0.070	37.6	0.386	-90.7	1.10	16.3
2.500	0.460	155.6	3.710	50.2	0.077	40.2	0.378	-104.1	1.19	14.2
3.000	0.495	146.2	3.086	38.9	0.087	42.5	0.393	-117.0	1.21	12.8
3.500	0.525	138.5	2.630	28.4	0.099	43.9	0.423	-128.4	1.17	11.8
4.000	0.549	131.2	2.287	18.3	0.114	44.0	0.462	-138.0	1.09	11.2
4.500	0.569	122.8	2.015	8.7	0.131	42.8	0.505	-145.7	1.01	11.4
5.000	0.589	113.1	1.790	-0.7	0.150	40.5	0.549	-152.0	0.92	10.8

Note:

1. Gain Calculation:

$$MAG = \frac{|S_{21}|}{|S_{12}|} (K \pm \sqrt{K^2 - 1})$$

When $K \leq 1$, MAG is undefined and MSG values are used. $MSG = \frac{|S_{21}|}{|S_{12}|}$, $K = \frac{1 + |\Delta|^2 - |S_{11}|^2 - |S_{22}|^2}{2 |S_{12} S_{21}|}$, $\Delta = S_{11} S_{22} - S_{21} S_{12}$

MAG = Maximum Available Gain

MSG = Maximum Stable Gain

EXCLUSIVE NORTH AMERICAN AGENT FOR **NEC** RF, MICROWAVE & OPTOELECTRONIC SEMICONDUCTORS

CEL CALIFORNIA EASTERN LABORATORIES • Headquarters • 4590 Patrick Henry Drive • Santa Clara, CA 95054-1817 • (408) 988-3500 • Telex 34-6393 • FAX (408) 988-0279

24-Hour Fax-On-Demand: 800-390-3232 (U.S. and Canada only) • Internet: <http://WWW.CEL.COM>

DATA SUBJECT TO CHANGE WITHOUT NOTICE



PRINTED IN USA ON RECYCLED PAPER -12/98