



NEX10000AUB

120 mA dual output LCD bias power supply

Rev. 2.1 — 5 March 2025

Product data sheet

1. General description

The NEX10000A is a power supply IC providing programmable positive and negative output voltages for TFT-LCD panels. The device features an integrated boost converter, LDO regulator and a negative charge pump. The device requires only a single inductor allowing for a small Bill-Of-Material and the smallest PCB area.

The NEX10000A has an input voltage range of 2.7 V to 5 V and can operate from single-cell Li-ion, Ni-Li and Li-Polymer batteries. It can supply up to 120 mA output current. The NEX10000A has excellent line transient and load transient responses.

2. Features and benefits

- Input voltage range: 2.7 V to 5 V
- Programmable output voltages:
 - OUTP: +4 V to +6.5 V (0.1 V step)
 - OUTN: -4 V to -6.5 V (0.1 V step)
- Maximum output current: 120 mA
- 86% high efficiency at 40 mA combined output
- ±1% output voltage accuracy
- Excellent transient response
- I²C Interface:
 - Flexible output voltage programming
- Integrated active output discharge function
- UVLO and OTSD protection
- Wafer level chip-scale package; 15 bumps; 1.16 × 1.96 × 0.62 mm body (0.4 mm pitch)
- ESD protection:
 - HBM: ANSI/ESDA/JEDEC JS-001 class 2 exceeds 2000 V
 - CDM: ANSI/ESDA/JEDEC JS-002 class C2a exceeds 500 V
- Specified from -40 °C to +85 °C

3. Applications

- Smart phone TFT-LCD
- Tablet TFT-LCD

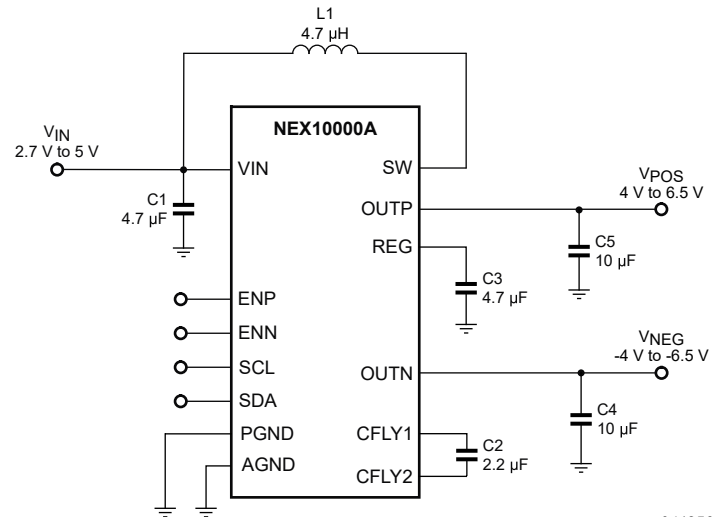

aaa-041256

Fig. 1. Typical application

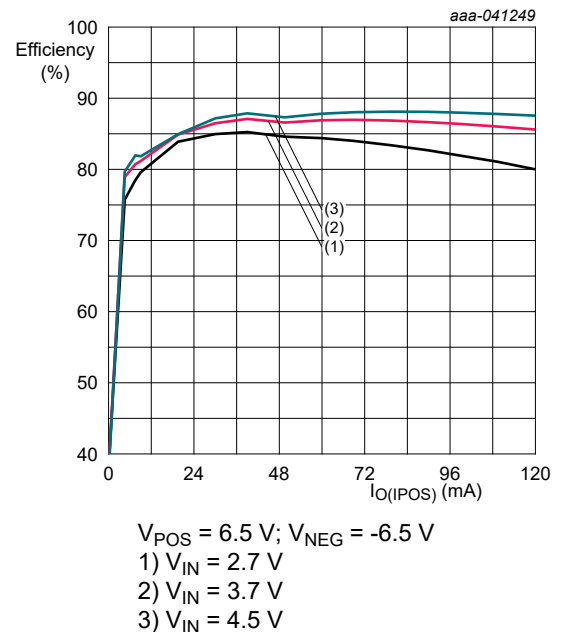

Fig. 2. Efficiency versus output current (I_o)

4. Ordering information

Table 1. Ordering information

Type number	Package			
	Temperature range	Name	Description	Version
NEX1000AUB	-40 °C to +85 °C	WLCSP15	wafer level chip-scale package; 15 bumps; 1.16 × 1.96 × 0.62 mm body	SOT8054-1

5. Marking

Table 2. Marking codes

Type number	Marking code
NEX1000AUB	NX12A

6. Functional diagram

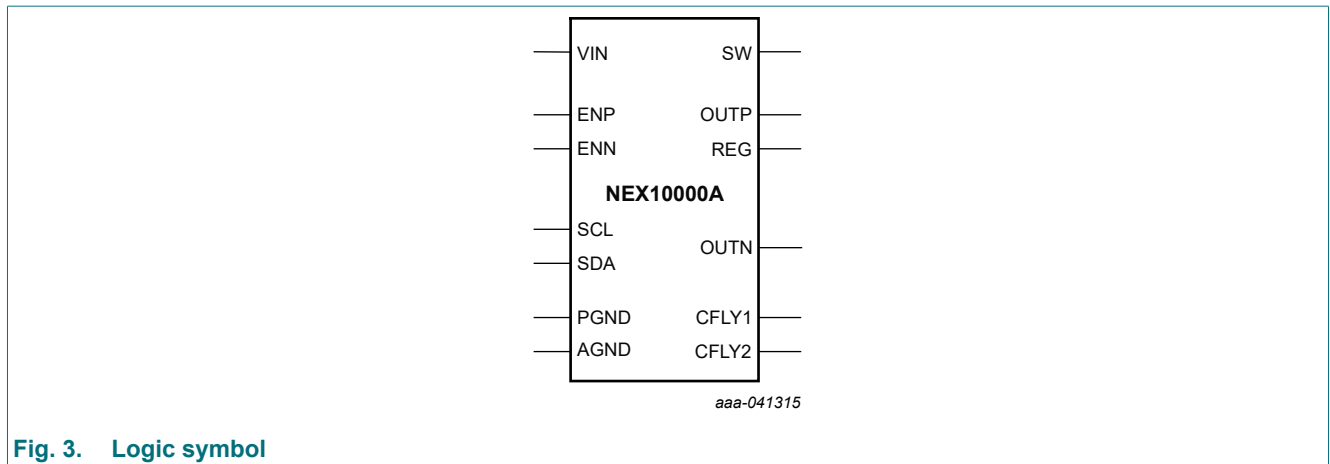

7. Pinning information

7.1. Pinning

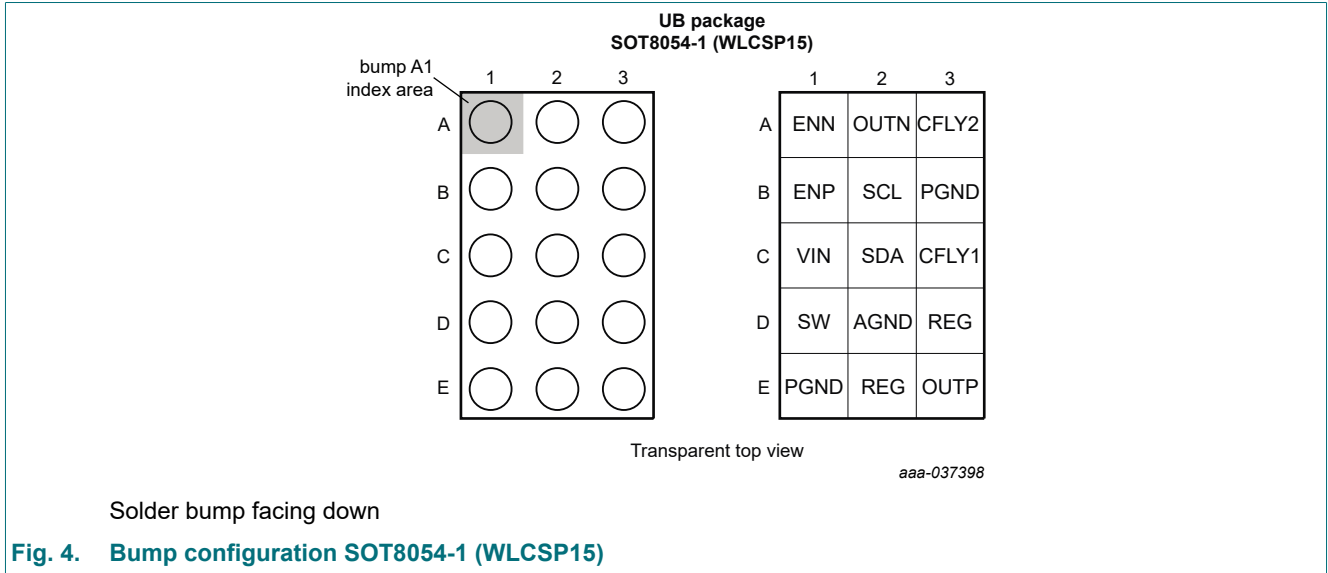

7.2. Pin description

Table 3. Pin description

Symbol	Bump	I/O	Description
	WLCSP15		
ENN	A1	I	Enable pin for V_{NEG} rail
OUTN	A2	O	Output pin of the negative charge pump (V_{NEG})
CFLY2	A3	I/O	Negative charge pump flying capacitor pin
ENP	B1	I	Enable pin for V_{POS} rail
SCL	B2	I/O	I ² C interface clock signal pin
PGND	B3	-	Power ground
VIN	C1	I	Input voltage supply pin
SDA	C2	I/O	I ² C interface data signal pin
CFLY1	C3	I/O	Negative charge pump flying capacitor pin
SW	D1	I/O	Switch pin of the boost converter
AGND	D2	-	Analog ground
REG	D3	I/O	Boost converter output pin
PGND	E1	-	Power ground
REG	E2	I/O	Boost converter output pin
OUTP	E3	O	Output pin of the LDO (V_{POS})

8. Device comparison

Table 4. Device Comparison

Type number		Output current (I_{OUT})
NEX1000AUB		120 mA
NEX1000UB	[1]	80 mA
NEX10001UB	[1]	220 mA

[1] Please see detail parameters from NEX1000UB and NEX10001UB data sheets.

9. Limiting values

Table 5. Limiting values

In accordance with the Absolute Maximum Rating System (IEC 60134). Voltages are referenced to GND (ground = 0 V).

Symbol	Parameter	Conditions	Min	Max	Unit
V_I	input voltage	pins ENN, ENP, VIN	-0.3	+5.5	V
V_O	output voltage	pin OUTN	-7	+0.3	V
		pin OUTP	-0.3	+7.0	V
V_{IO}	input/output voltage	pins SCL, SDA	-0.3	+5.5	V
		pins CFLY1, REG	-0.3	+7.1	V
		pins SW	-0.3	+7.5	V
		pin CFLY2	-7	+0.3	V
T_j	junction temperature		-40	+150	°C
T_{amb}	ambient temperature		-40	+85	°C
T_{stg}	storage temperature		-65	+150	°C
ESD ratings					
V_{ESD}	electrostatic discharge	HBM: ANSI/ESDA/JEDEC JS-001 class 2	-	±2000	V
		CDM: ANSI/ESDA/JEDEC JS-002 class C2a	-	±500	V

10. Recommended operating conditions

Table 6. Recommended operating conditions

Symbol	Parameter	Conditions	Min	Typ	Max	Unit
V_{IN}	input voltage	supply voltage pin VIN	2.7	-	5.0	V
I_O	output current		-	-	120	mA
L	inductor		2.2	-	4.7	μH
C_O	output capacitance	pins OUTN, OUTP, REG	-	4.7	10	μF
C_{IO}	input/output capacitance	pins CFLY1, CFLY2	2.2	-	4.7	μF
C_I	input capacitance	pin VIN	-	4.7	-	μF
T_{amb}	ambient temperature		-40	-	+85	°C
T_j	junction temperature		-40	-	+125	°C

11. Thermal Information

Table 7. Thermal information

Symbol	Parameter	Package	Unit
		SOT8054-1 (WLCSP15)	
R _{θJA}	Junction to ambient thermal resistance	76.4 [1]	°C/W

[1] Measured in still air-free convection condition (conforms to EIA/JESD51-2) on high effective thermal conductivity JESD51-9 with a test board PCB.

12. Electrical characteristics

Table 8. Electrical characteristics

At recommended operating conditions; $V_{IN} = 3.7\text{ V}$; $V_{ENN} = V_{ENP} = V_{IN}$; $V_{POS} = 5.4\text{ V}$; $V_{NEG} = -5.4\text{ V}$; (unless otherwise noted) voltages are referenced to GND (ground = 0 V).

Symbol	Parameter	Conditions	T _{amb} = -40 °C to +85 °C			Unit
			Min	Typ[1]	Max	
Supply						
V _{IN}	input voltage range		2.7	-	5.0	V
V _{UVLO}	undervoltage lockout threshold	V _{IN} rising	2.35	2.4	2.5	V
		V _{IN} falling	2.1	2.2	2.25	V
I _q	quiescent current	V _{ENP} = V _{ENN} = 3.7 V, switching	-	0.73	1.04	mA
I _{sd}	shutdown current	V _{ENP} = V _{ENN} = 0 V, no switching	-	-	1	μA
T _{sd}	shutdown temperature	[2]	-	140	-	°C
T _{sd(hys)}	shutdown temperature hysteresis	[2]	-	30	-	°C
Logic ENN, ENP						
V _{IH}	HIGH-level input voltage	V _{IN} = 2.7 V to 5 V	1.27	-	-	V
V _{IL}	LOW-level input voltage	V _{IN} = 2.7 V to 5 V	-	-	0.53	V
R _{EN}	pull-down resistor		-	220	-	kΩ
Logic SCL, SDA						
V _{IH}	HIGH-level input voltage	V _{IN} = 2.7 V to 5 V	1.27	-	-	V
V _{IL}	LOW-level input voltage	V _{IN} = 2.7 V to 5 V	-	-	0.53	V
Boost Converter						
I _{LIM}	boost converter current limit		1.3	1.6	1.9	A
f _{SW}	switching frequency	Boost converter switching frequency	1.15	1.4	1.65	MHz
LDO Output V_{POS}						
V _{POS}	positive output voltage range		4.0	-	6.5	V
V _{POS_acc}	positive output voltage accuracy		-1%	-	1%	V
I _{POS}	positive output current capability		200	-	-	mA
I _{POS_lim}	positive output current limit		255	275	310	mA
V _{DROP}	dropout voltage	V _{REG} = V _{POS(nom)} = 5.4 V, I _{OUT} = 120 mA	-	99	-	mV
ΔV _{LR}	line regulation	V _{IN} = 2.7 V to 5 V, I _{OUT} = 120 mA [2]	-	8	-	mV
ΔV _{LDR}	load regulation	V _{IN} = 3.7 V, ΔI _{OUT} = 120 mA [2]	-	10	-	mV
R _D	discharge resistor		-	23	-	Ω

Symbol	Parameter	Conditions	T _{amb} = -40 °C to +85 °C			Unit
			Min	Typ[1]	Max	
Negative charge pump output V_{NEG}						
V _{NEG}	negative output voltage range		-6.5	-	-4.0	V
V _{NEG_acc}	negative output voltage accuracy		-1%	-	1%	V
I _{NEG}	negative output current capability		120	-	-	mA
f _{OSC}	negative charge pump switching frequency		0.85	1	1.15	MHz
ΔV _{LR}	line regulation	V _{IN} = 2.7 V to 5 V, I _{OUT} = 120 mA	[2]	5	-	mV
ΔV _{LDR}	load regulation	V _{IN} = 3.7 V, ΔI _{OUT} = 120 mA	[2]	13	-	mV
R _D	discharge resistor		-	17.5	-	Ω
I²C Interface						
V _{IH}	HIGH-level input voltage	SDA, SCL, 2.7 V ≤ V _{IN} ≤ 5.0 V	1.27	-	-	V
V _{IL}	LOW-level input voltage	SDA, SCL, 2.7 V ≤ V _{IN} ≤ 5.0 V	-	-	0.53	V
f _{SCL}	SCL clock frequency	pin SCL	-	-	400	KHz

- [1] All typical values are measured at T_{amb} = 25 °C.
- [2] Guaranteed by bench test, not fully tested in production.

13. Typical characteristics

Table 9. Component list for typical characteristics circuit

V_{IN} = 3.7 V; V_{ENN} = V_{ENP} = V_{IN}; V_{POS} = 5.4 V; V_{NEG} = -5.4 V; T_{amb} = 25 °C; (unless otherwise noted) voltages are referenced to GND (ground = 0 V). See Fig. 5

Components	Description	Manufacture and part number
C1, C3	4.7 μF, 10 V, 0603, X5R, ceramic	TDK-C1608X5R1E475K080AC
C2	2.2 μF, 16 V, 0603, X5R, ceramic	TDK-C1608X5R1C225KTK00E
C4, C5	10 μF, 10 V, 0603, X5R, ceramic	TDK-C1608X5R1E106K080AC
L1	4.7 μF, 2.2 A, 180 mΩ, 2.5 mm × 2.0 mm × 1.2 mm	TDK-TMS252012ALM-4R7MTAA
U1	NEX1000AUB	NEXPERIA

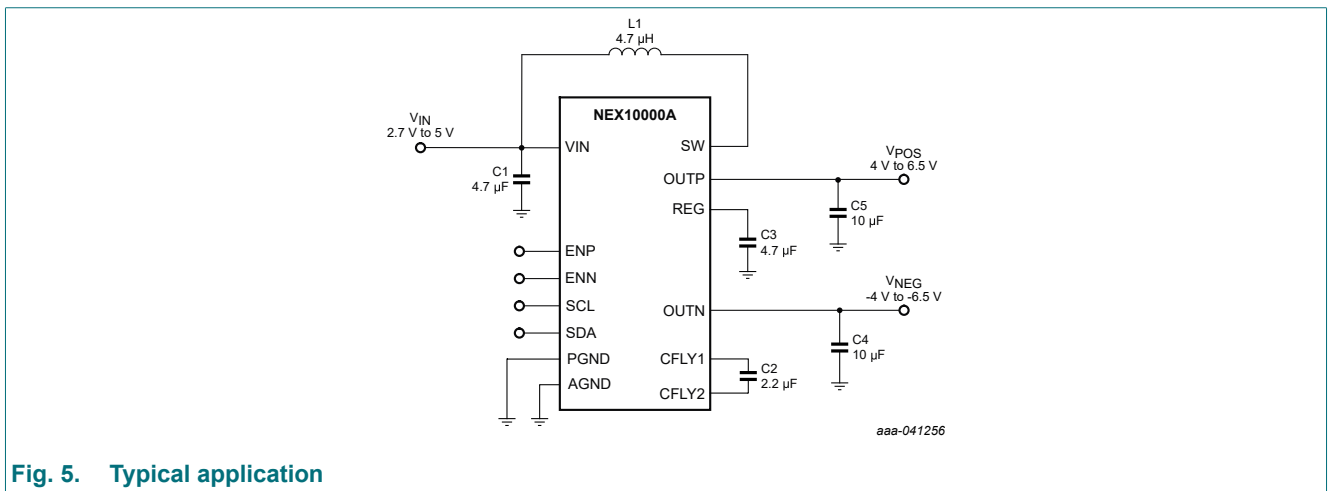
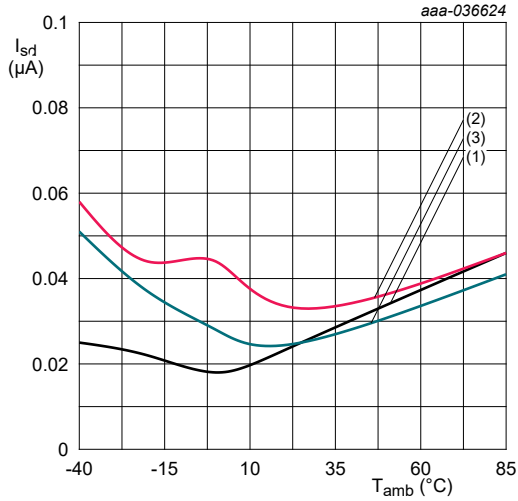
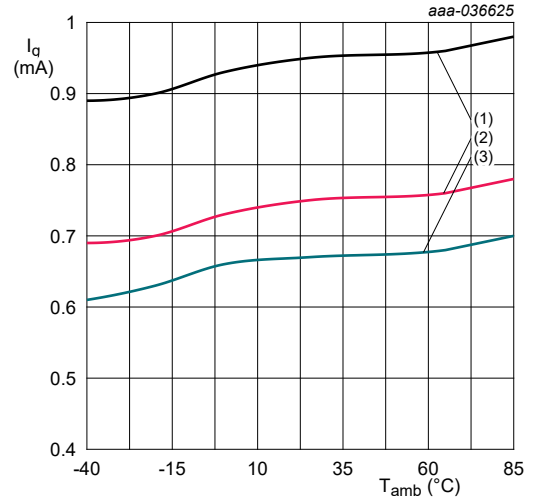

Fig. 5. Typical application



- (1) $V_{IN} = 2.7 V$
- (2) $V_{IN} = 3.7 V$
- (3) $V_{IN} = 4.5 V$

Fig. 6. Shutdown current (I_{sd}) versus ambient temperature (T_{amb})



- (1) $V_{IN} = 2.7 V$
- (2) $V_{IN} = 3.7 V$
- (3) $V_{IN} = 4.5 V$

Fig. 7. Quiescent current (I_q) versus ambient temperature (T_{amb})

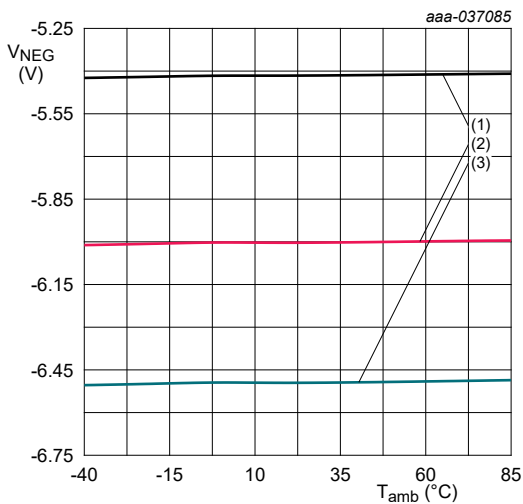

- (1) $V_{NEG} = -6.5 V$
- (2) $V_{NEG} = -6 V$
- (3) $V_{NEG} = -5.4 V$

Fig. 8. Negative output voltage (V_{NEG}) versus ambient temperature (T_{amb})

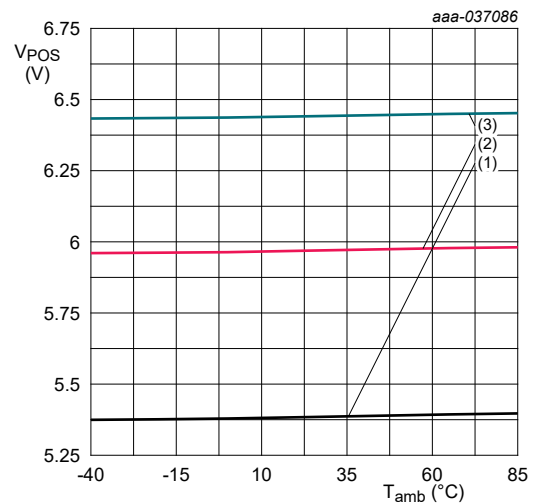

- (1) $V_{POS} = 5.4 V$
- (2) $V_{POS} = 6 V$
- (3) $V_{POS} = 6.5 V$

Fig. 9. Positive output voltage (V_{POS}) versus ambient temperature (T_{amb})

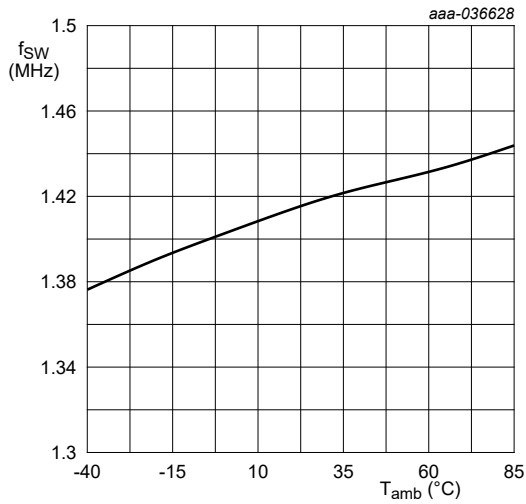
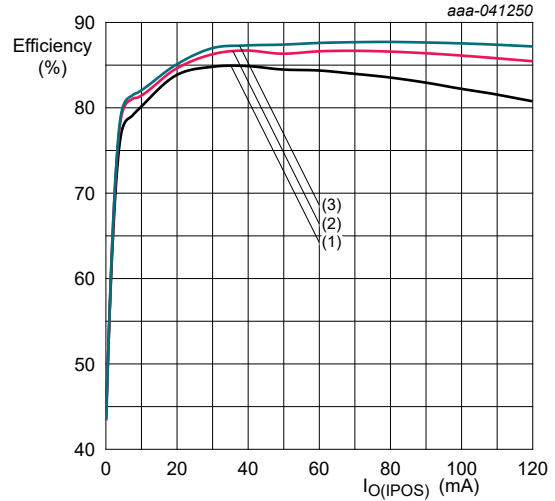

Fig. 10. Boost converter switching frequency (f_{sw}) versus ambient temperature (T_{amb})



$V_{POS} = 5.4 \text{ V}; V_{NEG} = -5.4 \text{ V}$

(1) $V_{IN} = 2.7 \text{ V}$

(2) $V_{IN} = 3.7 \text{ V}$

(3) $V_{IN} = 4.5 \text{ V}$

Fig. 11. Efficiency versus output current (I_o)

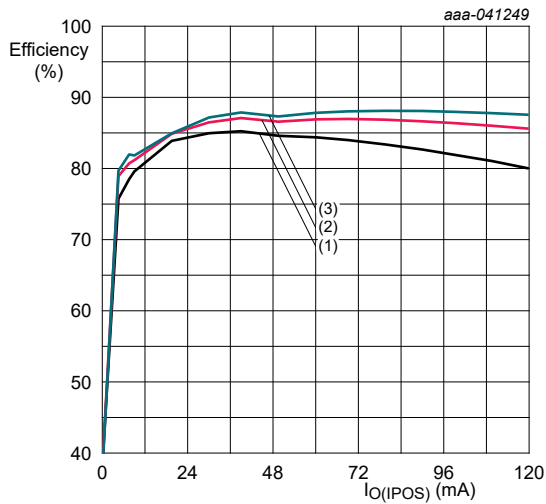

$V_{POS} = 6.5 \text{ V}; V_{NEG} = -6.5 \text{ V}$

(1) $V_{IN} = 2.7 \text{ V}$

(2) $V_{IN} = 3.7 \text{ V}$

(3) $V_{IN} = 4.5 \text{ V}$

Fig. 12. Efficiency versus output current (I_o)

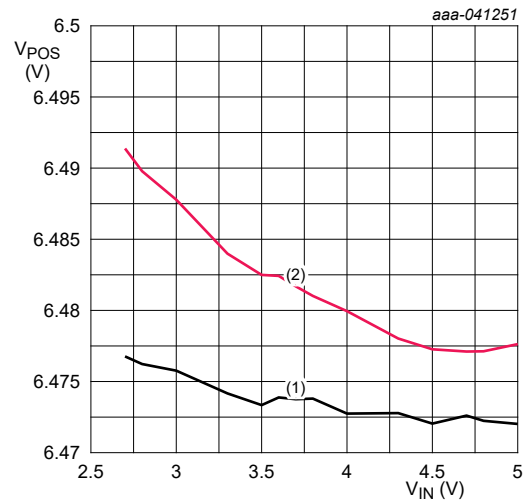

$V_{POS} = 6.5 \text{ V}$

(1) $I_{POS} = 0 \text{ mA}$

(2) $I_{POS} = 120 \text{ mA}$

Fig. 13. V_{POS} versus V_{IN} line regulation

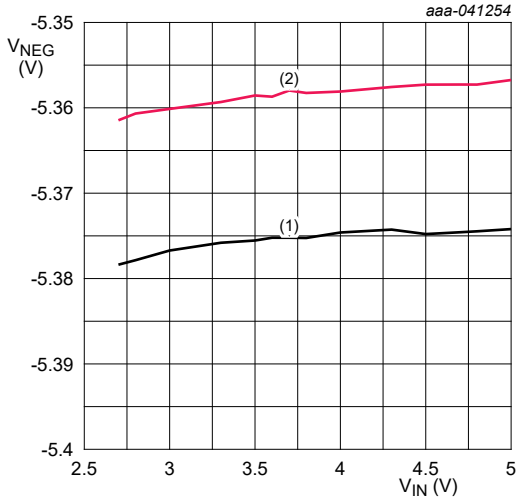

$V_{NEG} = -5.4 \text{ V}$
 (1) $I_{NEG} = 0 \text{ mA}$
 (2) $I_{NEG} = 120 \text{ mA}$

Fig. 14. V_{NEG} versus V_{IN} line regulation

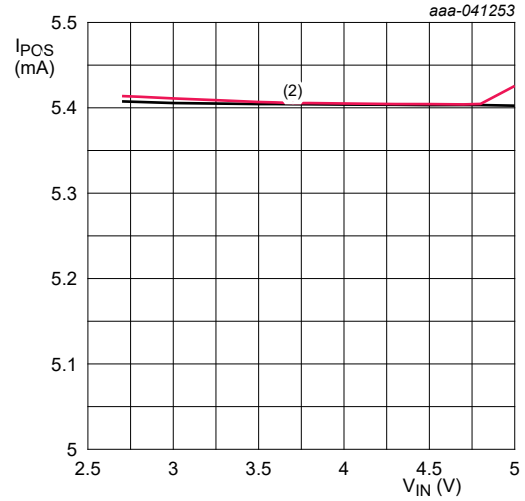

$V_{POS} = 5.4 \text{ V}$
 (1) $I_{POS} = 0 \text{ mA}$
 (2) $I_{POS} = 120 \text{ mA}$

Fig. 15. V_{POS} versus V_{IN} line regulation

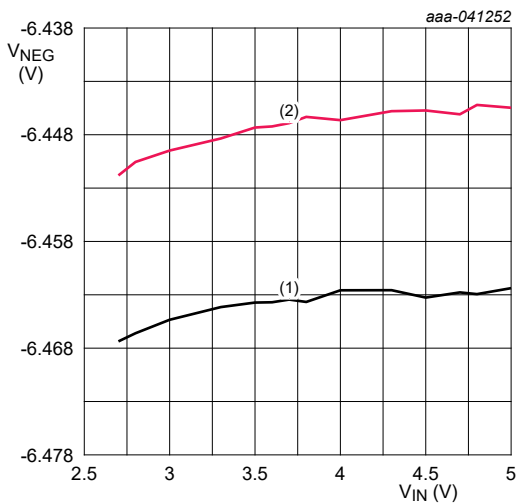

$V_{NEG} = -6.5 \text{ V}$
 (1) $I_{NEG} = 0 \text{ mA}$
 (2) $I_{NEG} = 120 \text{ mA}$

Fig. 16. V_{NEG} versus V_{IN} line regulation

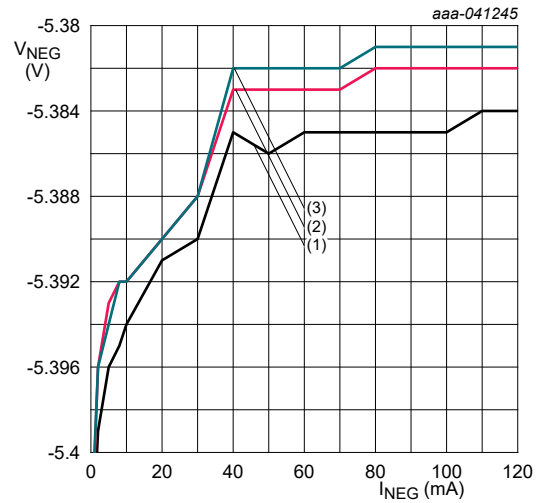

$V_{NEG} = -5.4 \text{ V}$
 (1) $V_{IN} = 2.7 \text{ V}$
 (2) $V_{IN} = 3.7 \text{ V}$
 (3) $V_{IN} = 4.5 \text{ V}$

Fig. 17. V_{NEG} versus positive negative current (load regulation)

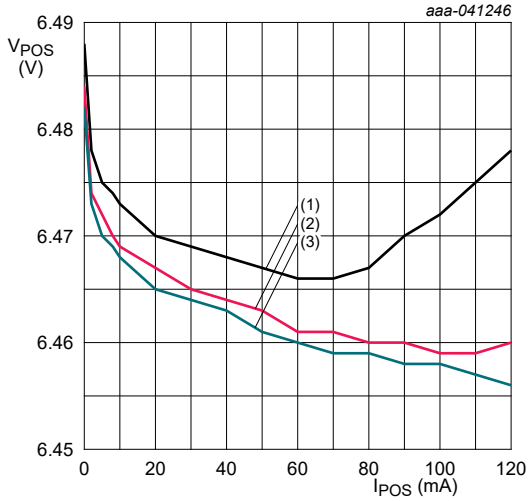

$V_{POS} = 6.5 \text{ V}$
 (1) $V_{IN} = 2.7 \text{ V}$
 (2) $V_{IN} = 3.7 \text{ V}$
 (3) $V_{IN} = 4.5 \text{ V}$

Fig. 18. V_{POS} versus positive output current (load regulation)

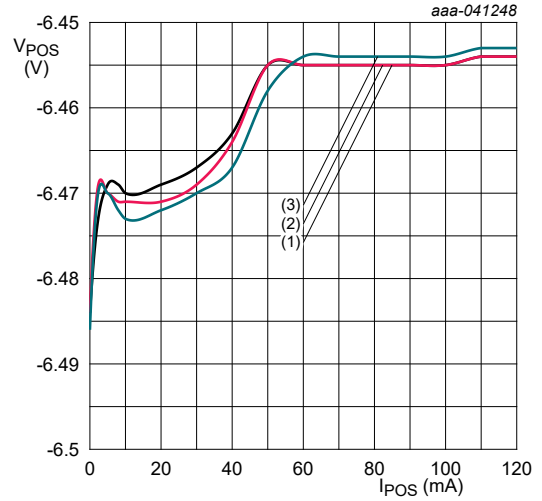

$V_{NEG} = -6.5 \text{ V}$
 (1) $V_{IN} = 2.7 \text{ V}$
 (2) $V_{IN} = 3.7 \text{ V}$
 (3) $V_{IN} = 4.5 \text{ V}$

Fig. 19. V_{NEG} versus negative output current (load regulation)

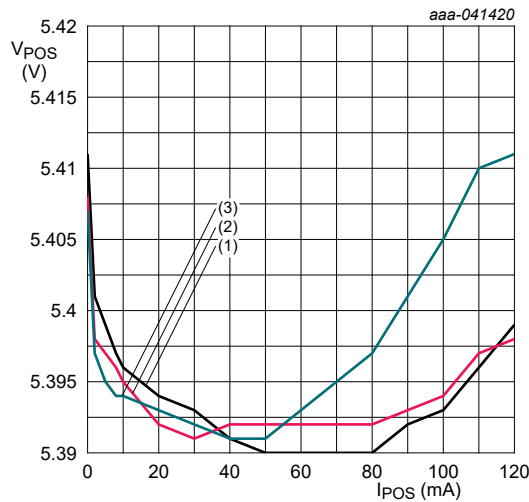

$V_{POS} = 5.4 \text{ V}$
 (1) $V_{IN} = 2.7 \text{ V}$
 (2) $V_{IN} = 3.7 \text{ V}$
 (3) $V_{IN} = 4.5 \text{ V}$

Fig. 20. V_{POS} versus positive output current (load regulation)

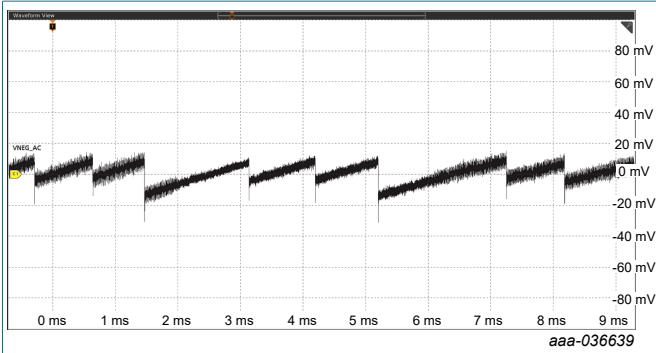

Fig. 21. V_{NEG} output ripple ($I_{NEG} = 0$ mA)

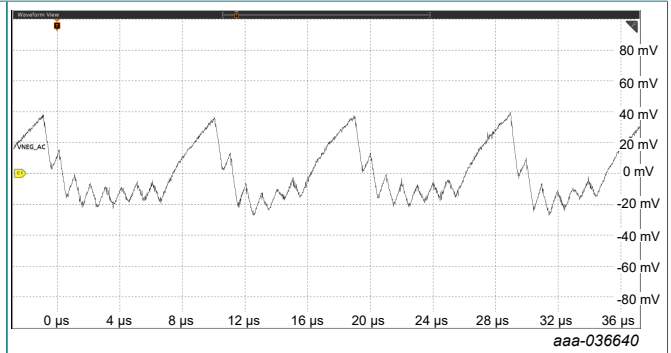

Fig. 22. V_{NEG} output ripple ($I_{NEG} = 40$ mA)

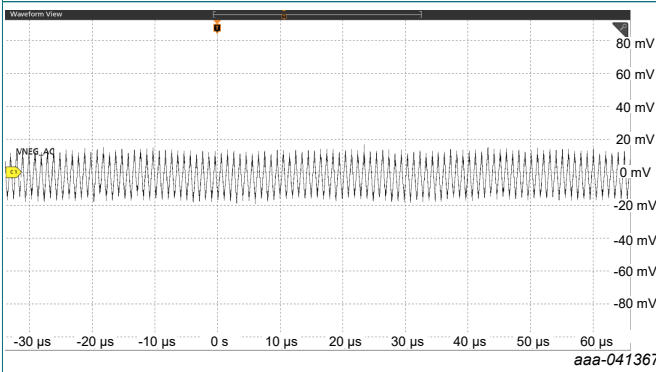

Fig. 23. V_{NEG} output ripple ($I_{NEG} = 120$ mA)

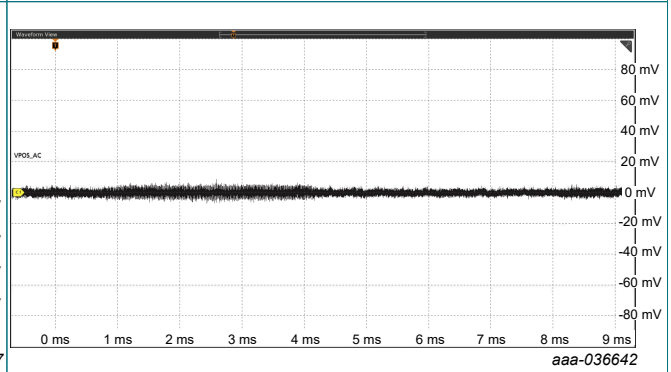

Fig. 24. V_{POS} output ripple ($I_{POS} = 0$ mA)

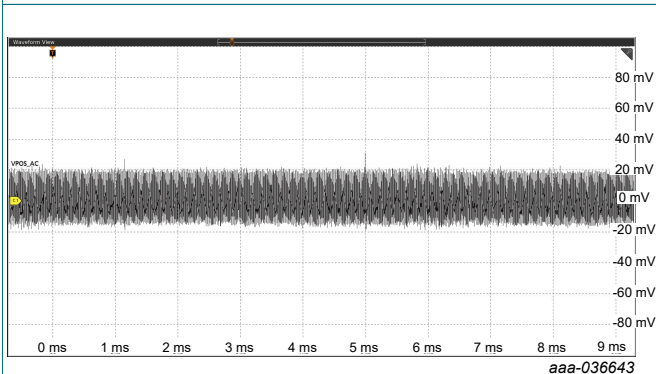

Fig. 25. V_{POS} output ripple ($I_{POS} = 40$ mA)

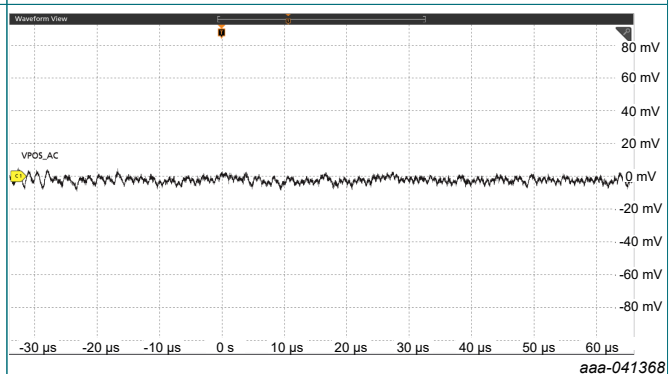

Fig. 26. V_{POS} output ripple ($I_{POS} = 120$ mA)

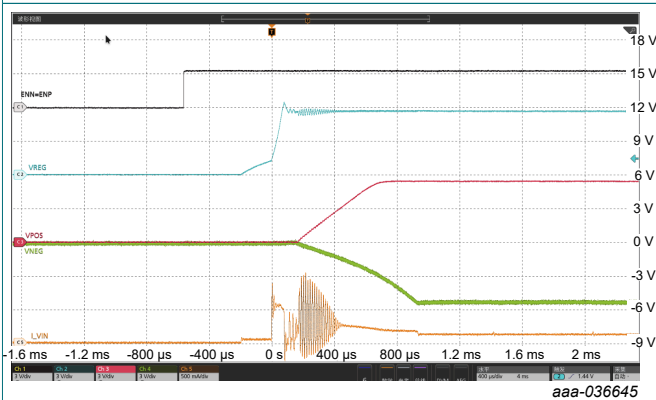

Fig. 27. Simultaneous power-up and inrush current

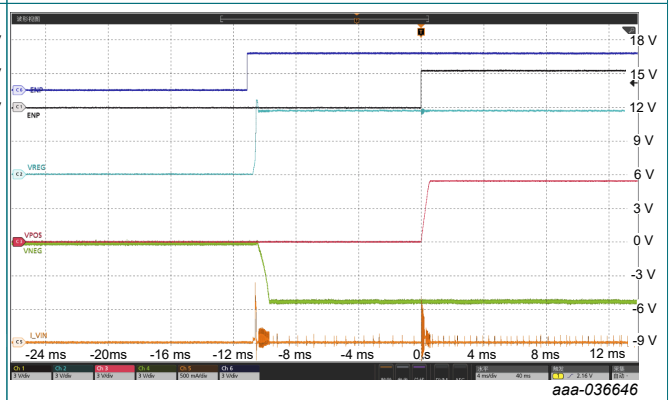

Fig. 28. Sequential power-up and inrush current

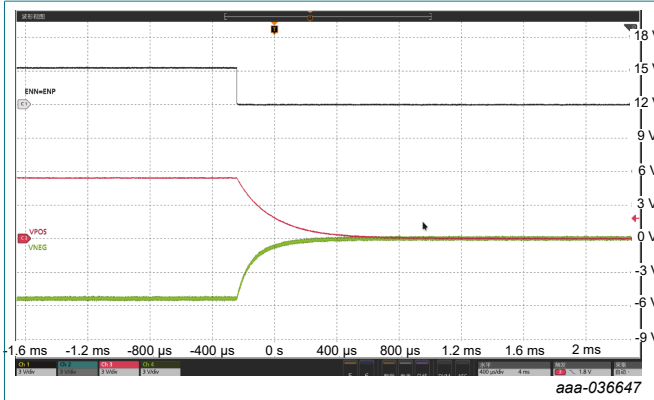

Fig. 29. Simultaneous shut-down

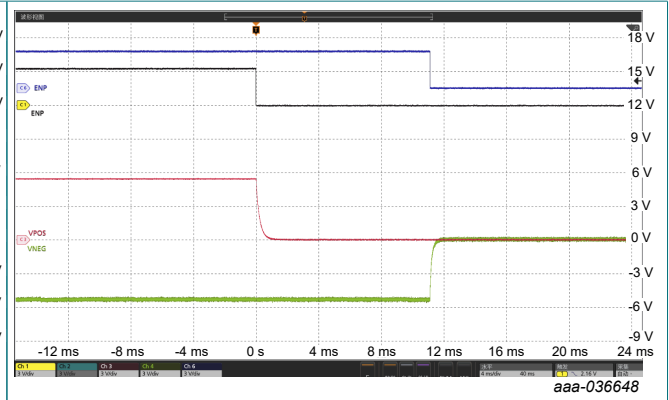
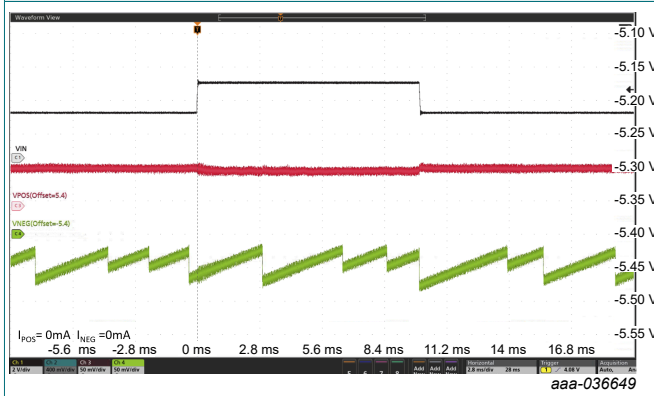
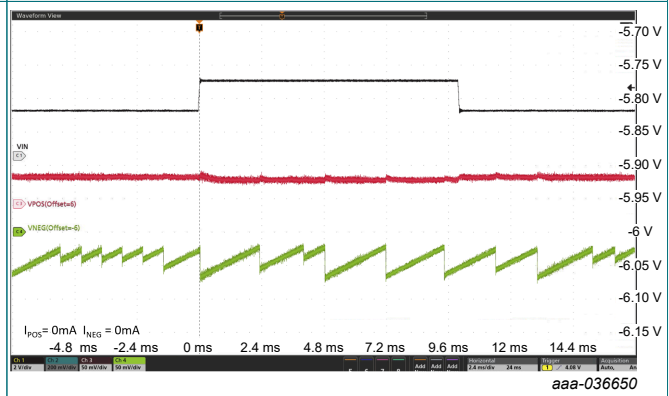

Fig. 30. Sequential shut-down



$V_{IN} = 2.7\text{ V to }4.5\text{ V}; |V_{OUT}| = 5.4\text{ V}$
 $I_{POS} = I_{NEG} = 0\text{ mA}$

Fig. 31. Line transient



$V_{IN} = 2.7\text{ V to }4.5\text{ V}; |V_{OUT}| = 6\text{ V}$
 $I_{POS} = I_{NEG} = 0\text{ mA}$

Fig. 32. Line transient

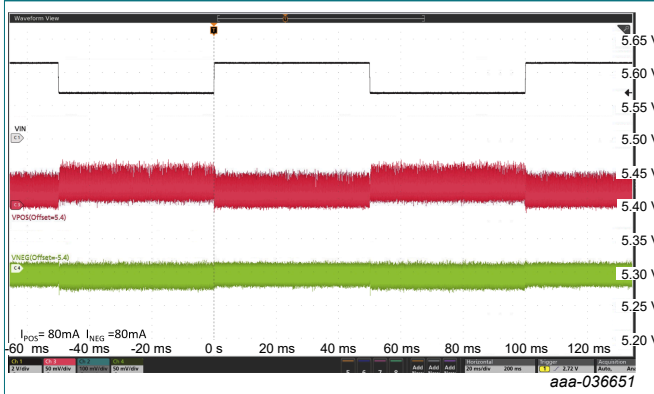

$V_{IN} = 2.7\text{ V to }4.5\text{ V}; |V_{OUT}| = 5.4\text{ V}$
 $I_{POS} = I_{NEG} = 80\text{ mA}$

Fig. 33. Line transient

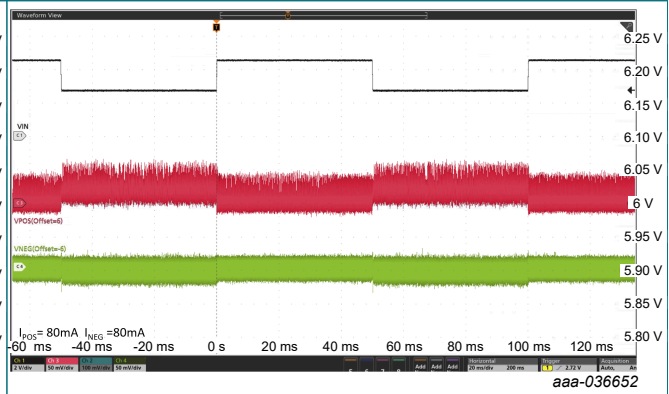

$V_{IN} = 2.7\text{ V to }4.5\text{ V}; |V_{OUT}| = 6\text{ V}$
 $I_{POS} = I_{NEG} = 80\text{ mA}$

Fig. 34. Line transient

120 mA dual output LCD bias power supply

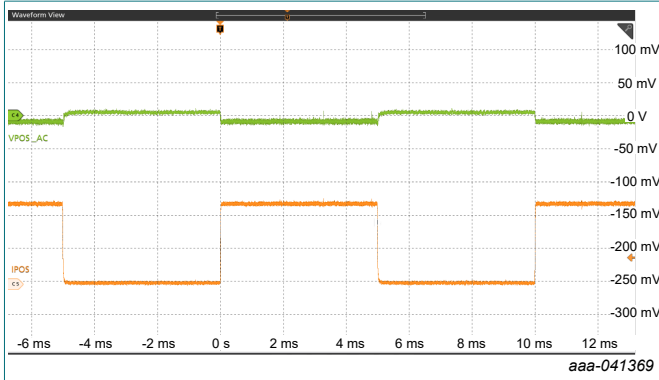

$V_{POS} = 6.5\text{ V}; I_{POS} = 0\text{ mA to }120\text{ mA}$

Fig. 35. Load transient

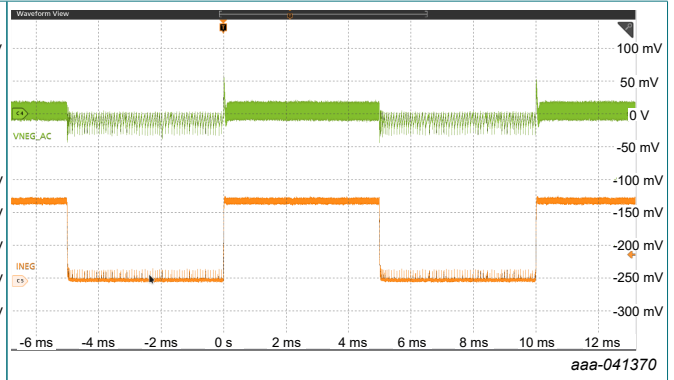

$V_{NEG} = -6.5\text{ V}; I_{NEG} = 0\text{ mA to }120\text{ mA}$

Fig. 36. Load transient

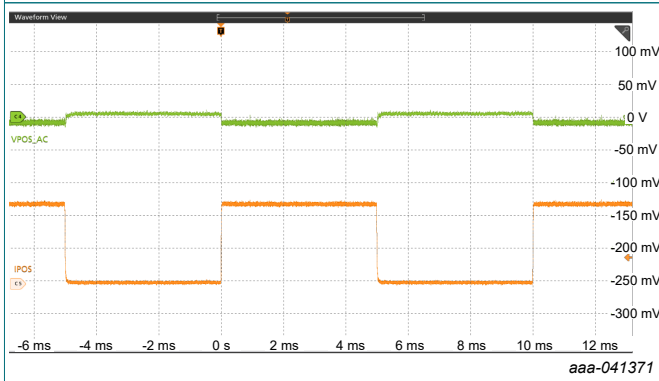

$V_{POS} = 5.4\text{ V}; I_{POS} = 0\text{ mA to }120\text{ mA}$

Fig. 37. Load transient

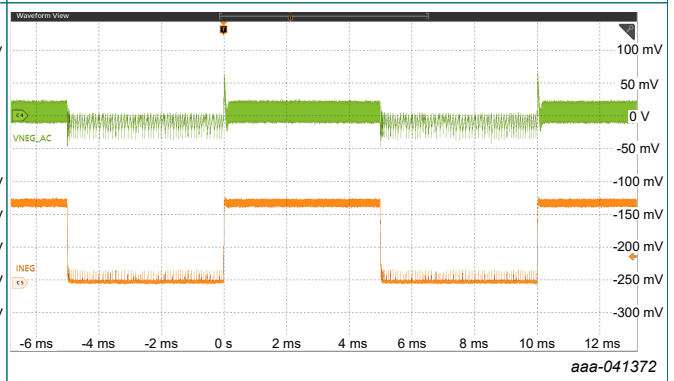

$V_{NEG} = -5.4\text{ V}; I_{NEG} = 0\text{ mA to }120\text{ mA}$

Fig. 38. Load transient

14. Detailed description

14.1. Overview

The NEX10000A, supporting input voltage range from 2.7 V to 5 V, operates with a single inductor scheme to provide high efficiency with small solution size. The synchronous boost converter generates a positive voltage that is regulated down by an integrated Low Dropout (LDO) regulator, outputting the positive supply rail (V_{POS}). The negative supply rail (V_{NEG}) is generated by an integrated negative charge pump (CPN) driven from the boost converter output pin, REG. The device is programmable over an I²C compatible interface for both V_{POS} and V_{NEG} . The device topology allows a 100% asymmetry of the output voltages and currents.

14.2. Function block diagram

The NEX10000A function block diagram is shown in [Fig. 39](#).

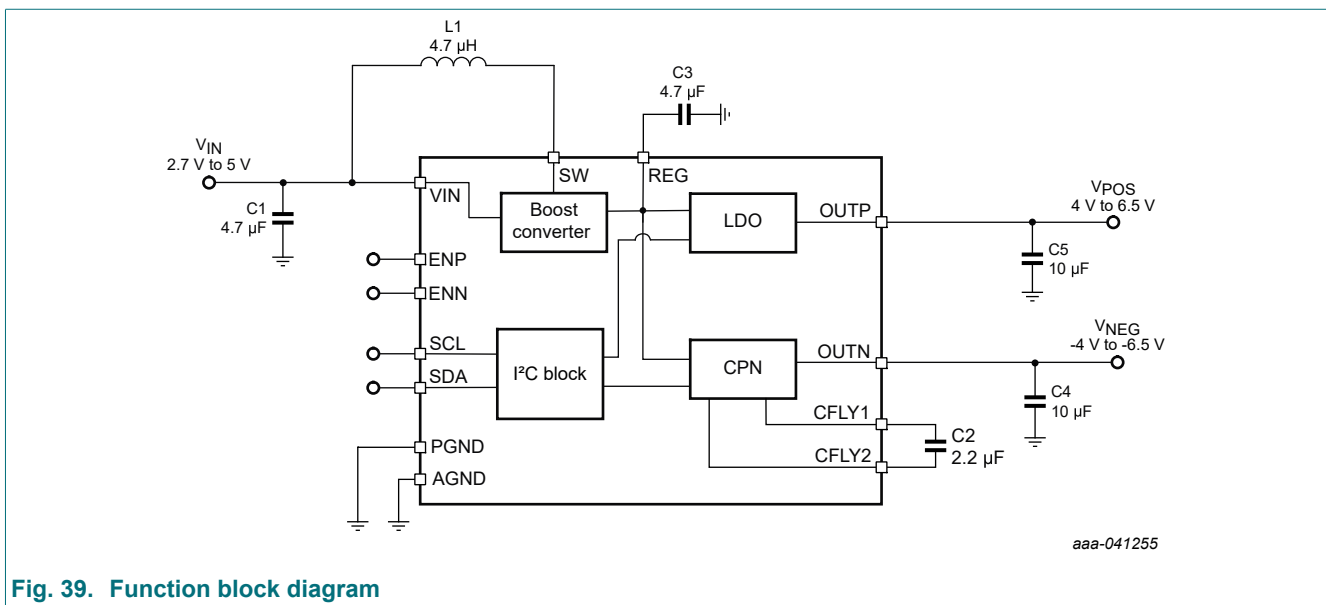

Fig. 39. Function block diagram

14.3. Feature description

14.3.1. Undervoltage lockout (UVLO)

The NEX10000A integrates an undervoltage lockout block (UVLO) that enables the device once the voltage on the VIN pin exceeds the UVLO threshold (2.5 V maximum). No output voltage will be generated if the enable signals are not pulled HIGH. The device, as well as all converters (boost converter, LDO, CPN), will be disabled as soon as the V_{IN} voltage falls below the UVLO threshold. The UVLO threshold is designed with a hysteresis, the NEX10000A will continue operating as long as V_{IN} stays above 2.25 V. This guarantees proper operation even in the event of extensive line transients when the battery gets suddenly heavily loaded.

14.3.2. Thermal shutdown

The device has a built-in temperature sensor which monitors the internal junction temperature. When the junction temperature exceeds 140 °C, NEX10000A will shut down. When the junction temperature falls below the thermal recovery temperature, approximately 110 °C, the device restarts by using soft-start sequence.

14.3.3. Boost converter

14.3.3.1. Boost converter operation

The synchronous boost converter uses current mode topology with a typical switching frequency of 1.4 MHz, allowing a 2.2 μH or 4.7 μH inductor to be used, we recommend using 4.7 μH . The converter is internally compensated and provides a regulated output voltage automatically adjusted depending on the programmed V_{POS} and V_{NEG} voltages. The boost converter operates either in Continuous Conduction Mode (CCM) or Pulse Frequency Modulation mode (PFM), depending on the load current to provide the highest efficiency.

14.3.3.2. Power-up and soft-start (Boost converter)

The Boost converter starts switching as soon as ENP or ENN is pulled high and the voltage on VIN pin is higher than UVLO threshold.

The boost converter starts up with internal soft start to avoid drawing excessive inrush current from the supply. The output voltage V_{REG} is slowly ramped up to its target value. Typical startup waveforms are shown in [Fig. 27](#).

14.3.3.3. Power-down (Boost converter)

The boost converter stops switching when V_{IN} is below the V_{UVLO} threshold or when both ENP and ENN are pulled LOW.

14.3.3.4. Output voltage (Boost converter)

V_{REG} , the output voltage of boost converter is automatically adjusted according to the programmed V_{POS} and V_{NEG} voltages. V_{REG} will maintain a fixed voltage difference with the large values in V_{POS} and V_{NEG} .

14.3.3.5. Isolation (Boost converter)

The boost converter output (REG) is isolated from the input supply VIN, providing a true shutdown.

14.3.4. LDO regulator

14.3.4.1. LDO operation

The Low Dropout regulator (LDO) generates the positive voltage rail, V_{POS} , by regulating down the output voltage of the boost converter (V_{REG}). The high PSRR LDO helps filtering the output ripple of the boost converter to provide low ripple V_{POS} voltage.

14.3.4.2. Power-up and soft-start (LDO)

The LDO starts operating as soon as the ENP signal is pulled HIGH and V_{IN} voltage is above the UVLO threshold and the boost converter has reached its Power Good threshold. In the case where the enable signal is already HIGH when V_{IN} exceeds the UVLO threshold, the boost converter will start first and the LDO will only start after the boost converter has reached its target voltage.

The LDO integrates a soft start that slowly ramps up its output voltage V_{POS} regardless of the output capacitor and the target voltage, if the LDO current limit is not reached, the typical startup time is around 500 μs . Typical startup waveform for LDO is shown in [Fig. 27](#).

14.3.4.3. Power-down and discharge (LDO)

The LDO stops operating when V_{IN} is below the UVLO threshold or when ENP is pulled LOW. The NEX10000A integrates actively discharge function for V_{POS} . Typical power down waveform for LDO is shown in [Fig. 29](#).

14.3.4.4. Setting output voltage (LDO)

The output voltage of the LDO is programmable via I²C interface, from 4.0 V to 6.5 V in 100 mV steps. For more details, please refer to the V_{POS} Register – Address: 0x00.

14.3.4.5. Isolation (LDO)

The LDO isolates the V_{POS} rail from V_{REG} (boost converter output) if the rail is not enabled to ensure flexible startup like V_{NEG} before V_{POS} .

14.3.5. Negative charge pump

14.3.5.1. CPN operation

The negative charge pump (CPN) generates the negative voltage rail, V_{NEG} , by inverting and regulating the output voltage of the boost converter (V_{REG}). The charge pump uses 4 switches and an external flying capacitor to generate the negative rail. Two of the switches are turned on in the first phase to charge the flying capacitor up to V_{REG} , and in the second phase they are turned-off and the two others turn on to pump the energy negatively out of the OUTN capacitor.

14.3.5.2. Power-up and soft-start (CPN)

The CPN starts operating as soon as the ENN signal is pulled HIGH and V_{IN} voltage is above the UVLO threshold and the boost converter has reached its power good threshold. In the case where the enable signal is already HIGH when V_{IN} reaches the UVLO threshold, the boost converter will start first and the CPN will only start after the boost converter has reached its target voltage. Typical startup waveform for CPN is shown in [Fig. 27](#).

The CPN integrates a soft start that slowly ramps up its output voltage V_{NEG} within a time. The time is determined by the output voltage and the output capacitor value.

The estimated startup time can be calculated using the following formula: $t_{STARTUP} = \frac{C_{OUT} \times V_{NEG}}{I_{STARTUP}}$

Where:

$t_{STARTUP}$ = start-up time of the V_{NEG} rail

C_{OUT} = output capacitance of the V_{NEG} rail

V_{NEG} = target output voltage

$I_{STARTUP}$ is the output current of V_{NEG} to charge up the output capacitor at start-up

14.3.5.3. Power-down and discharge (CPN)

The CPN will stop operating when V_{IN} is below the UVLO threshold or when ENN is pulled LOW. NEX10000A integrates actively discharge function for V_{NEG} . Typical power-down waveform for V_{NEG} is shown in [Fig. 29](#).

14.3.5.4. Setting output voltage (CPN)

The output voltage of the CPN is programmable via I²C interface, from -6.5 V to -4.0 V in 100 mV steps. For more details, please refer to the V_{NEG} Register – Address: 0x01.

14.3.5.5. Isolation (CPN)

The CPN isolates the V_{NEG} rail from V_{REG} (boost converter output) as long as the rail is not enabled in order to ensure flexible startup like V_{POS} before V_{NEG} .

14.4. I²C interface

NEX10000 integrates an industry standard I²C compatible interface as a slave. The slave address is 0x3E.

14.5. Register configuration

Table 10. Register map

Address	Register name	R/W	Bit7	Bit6	Bit5	Bit4	Bit3	Bit2	Bit1	Bit0	Default
0x00[1]	V _{POS} register	R/W	reserved			V _{POS} [4:0]				0x0E	
0x01[1]	V _{NEG} register	R/W	reserved			V _{NEG} [4:0]				0x0E	
0x02	Vendor ID	R/W	reserved						11	0x03	

[1] 0x00 and 0x01: the relationship between V_{POS}, V_{NEG} registers and V_{POS}, V_{NEG} voltages are shown in [Table 11](#).

Table 11. V_{POS} and V_{NEG} voltages

V _{POS} [4:0]	V _{POS} voltage [V]	V _{NEG} [4:0]	V _{NEG} voltage [V]
0x00	4.0	0x00	-4.0
0x01	4.1	0x01	-4.1
0x02	4.2	0x02	-4.2
0x03	4.3	0x03	-4.3
0x04	4.4	0x04	-4.4
0x05	4.5	0x05	-4.5
0x06	4.6	0x06	-4.6
0x07	4.7	0x07	-4.7
0x08	4.8	0x08	-4.8
0x09	4.9	0x09	-4.9
0x0A	5.0	0x0A	-5.0
0x0B	5.1	0x0B	-5.1
0x0C	5.2	0x0C	-5.2
0x0D	5.3	0x0D	-5.3
0x0E	5.4 (Default value)	0x0E	-5.4 (Default value)
0x0F	5.5	0x0F	-5.5
0x10	5.6	0x10	-5.6
0x11	5.7	0x11	-5.7
0x12	5.8	0x12	-5.8
0x13	5.9	0x13	-5.9
0x14	6.0	0x14	-6.0
0x15	6.1	0x15	-6.1
0x16	6.2	0x16	-6.2
0x17	6.3	0x17	-6.3
0x18	6.4	0x18	-6.4
0x19	6.5	0x19	-6.5

Table 12. Definition of 0x02 register

Bit	Field	Description	Value	Action
7:2	Reserved			
1:0	Vendor ID	Vendor ID	11	Read only Vendor ID

15. Package outline

WLCSP15: wafer level chip-scale package; 15 bumps; 1.16 × 1.96 × 0.62 mm body

SOT8054-1

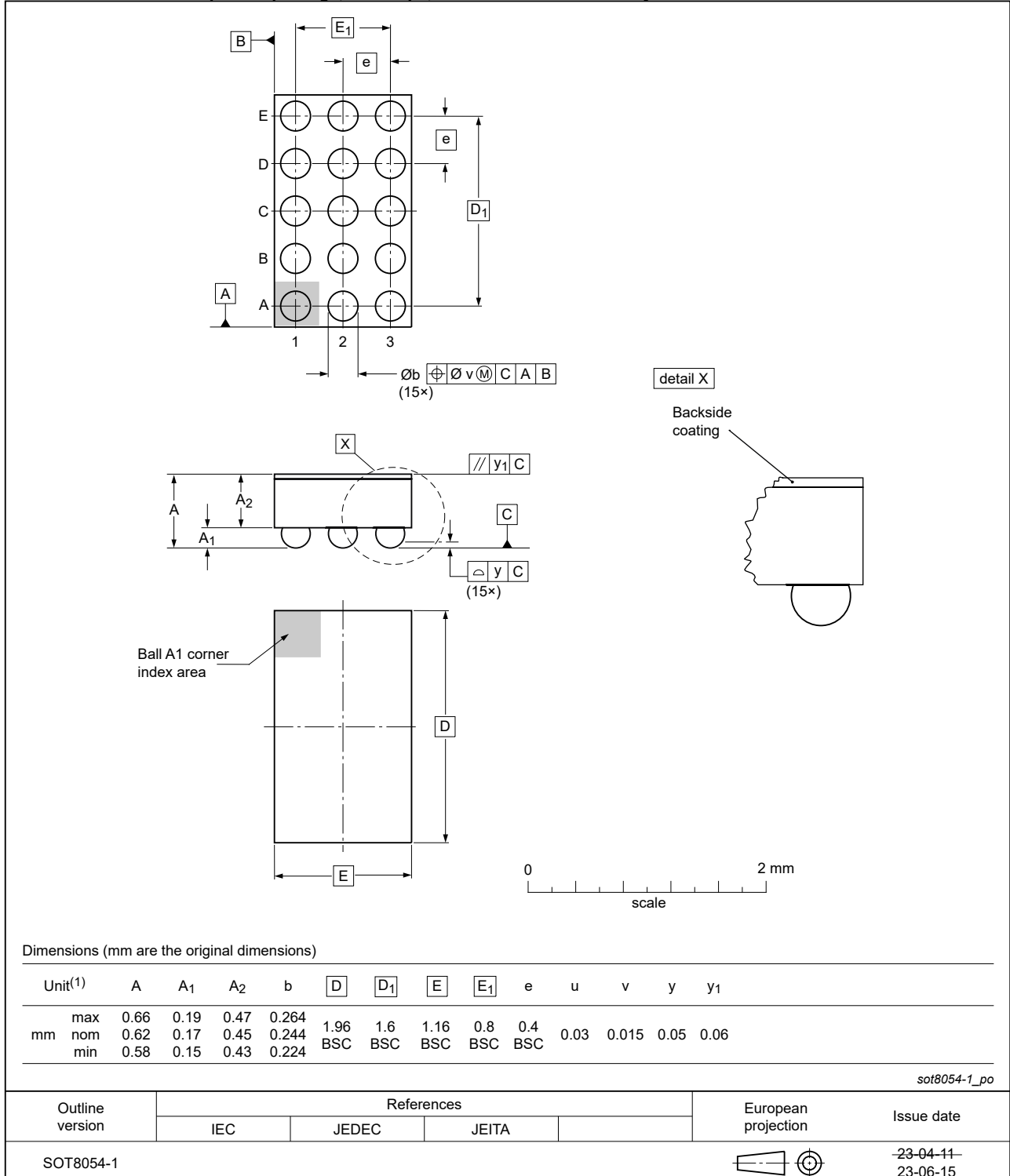

Fig. 40. Package outline SOT8054-1 (WLCSP15)

16. Abbreviations

Table 13. Abbreviations

Acronym	Description
CCM	Continuous Conduction Mode
CDM	Charged Device Model
CPN	Negative Charge Pump
ESD	ElectroStatic Discharge
HBM	Human Body Model
LDO	Low Dropout
OTSD	Over Temperature Shut Down
PCB	Printed Circuit Board
PFM	Pulse Frequency Modulation
PSRR	Power Supply Rejection Ratio
TFT-LCD	Thin Film Transistor-Liquid Crystal Display
UVLO	Undervoltage Lockout

17. Revision history

Table 14. Revision history

Document ID	Release date	Data sheet status	Change notice	Supersedes
NEX1000AUB v. 2.1	20250305	Product data sheet	-	NEX1000AUB v. 2
Modification:	Table 8 : The parameter I_{NEG_lim} has been removed.			
NEX1000AUB v. 2	20250228	Product data sheet	-	NEX1000AUB v. 1
Modifications:	Table 8 : The maximum value of V_{POS} and the minimum value of V_{NEG} have changed.			
NEX1000AUB v. 1	20241029	Product data sheet	-	-

18. Legal information

Data sheet status

Document status [1][2]	Product status [3]	Definition
Objective [short] data sheet	Development	This document contains data from the objective specification for product development.
Preliminary [short] data sheet	Qualification	This document contains data from the preliminary specification.
Product [short] data sheet	Production	This document contains the product specification.

- [1] Please consult the most recently issued document before initiating or completing a design.
- [2] The term 'short data sheet' is explained in section "Definitions".
- [3] The product status of device(s) described in this document may have changed since this document was published and may differ in case of multiple devices. The latest product status information is available on the internet at <https://www.nexperia.com>.

Definitions

Draft — The document is a draft version only. The content is still under internal review and subject to formal approval, which may result in modifications or additions. Nexperia does not give any representations or warranties as to the accuracy or completeness of information included herein and shall have no liability for the consequences of use of such information.

Short data sheet — A short data sheet is an extract from a full data sheet with the same product type number(s) and title. A short data sheet is intended for quick reference only and should not be relied upon to contain detailed and full information. For detailed and full information see the relevant full data sheet, which is available on request via the local Nexperia sales office. In case of any inconsistency or conflict with the short data sheet, the full data sheet shall prevail.

Product specification — The information and data provided in a Product data sheet shall define the specification of the product as agreed between Nexperia and its customer, unless Nexperia and customer have explicitly agreed otherwise in writing. In no event however, shall an agreement be valid in which the Nexperia product is deemed to offer functions and qualities beyond those described in the Product data sheet.

Disclaimers

Limited warranty and liability — Information in this document is believed to be accurate and reliable. However, Nexperia does not give any representations or warranties, expressed or implied, as to the accuracy or completeness of such information and shall have no liability for the consequences of use of such information. Nexperia takes no responsibility for the content in this document if provided by an information source outside of Nexperia.

In no event shall Nexperia be liable for any indirect, incidental, punitive, special or consequential damages (including - without limitation - lost profits, lost savings, business interruption, costs related to the removal or replacement of any products or rework charges) whether or not such damages are based on tort (including negligence), warranty, breach of contract or any other legal theory.

Notwithstanding any damages that customer might incur for any reason whatsoever, Nexperia's aggregate and cumulative liability towards customer for the products described herein shall be limited in accordance with the Terms and conditions of commercial sale of Nexperia.

Right to make changes — Nexperia reserves the right to make changes to information published in this document, including without limitation specifications and product descriptions, at any time and without notice. This document supersedes and replaces all information supplied prior to the publication hereof.

Suitability for use — Nexperia products are not designed, authorized or warranted to be suitable for use in life support, life-critical or safety-critical systems or equipment, nor in applications where failure or malfunction of an Nexperia product can reasonably be expected to result in personal

injury, death or severe property or environmental damage. Nexperia and its suppliers accept no liability for inclusion and/or use of Nexperia products in such equipment or applications and therefore such inclusion and/or use is at the customer's own risk.

Quick reference data — The Quick reference data is an extract of the product data given in the Limiting values and Characteristics sections of this document, and as such is not complete, exhaustive or legally binding.

Applications — Applications that are described herein for any of these products are for illustrative purposes only. Nexperia makes no representation or warranty that such applications will be suitable for the specified use without further testing or modification.

Customers are responsible for the design and operation of their applications and products using Nexperia products, and Nexperia accepts no liability for any assistance with applications or customer product design. It is customer's sole responsibility to determine whether the Nexperia product is suitable and fit for the customer's applications and products planned, as well as for the planned application and use of customer's third party customer(s). Customers should provide appropriate design and operating safeguards to minimize the risks associated with their applications and products.

Nexperia does not accept any liability related to any default, damage, costs or problem which is based on any weakness or default in the customer's applications or products, or the application or use by customer's third party customer(s). Customer is responsible for doing all necessary testing for the customer's applications and products using Nexperia products in order to avoid a default of the applications and the products or of the application or use by customer's third party customer(s). Nexperia does not accept any liability in this respect.

Limiting values — Stress above one or more limiting values (as defined in the Absolute Maximum Ratings System of IEC 60134) will cause permanent damage to the device. Limiting values are stress ratings only and (proper) operation of the device at these or any other conditions above those given in the Recommended operating conditions section (if present) or the Characteristics sections of this document is not warranted. Constant or repeated exposure to limiting values will permanently and irreversibly affect the quality and reliability of the device.

Terms and conditions of commercial sale — Nexperia products are sold subject to the general terms and conditions of commercial sale, as published at <http://www.nexperia.com/profile/terms>, unless otherwise agreed in a valid written individual agreement. In case an individual agreement is concluded only the terms and conditions of the respective agreement shall apply. Nexperia hereby expressly objects to applying the customer's general terms and conditions with regard to the purchase of Nexperia products by customer.

No offer to sell or license — Nothing in this document may be interpreted or construed as an offer to sell products that is open for acceptance or the grant, conveyance or implication of any license under any copyrights, patents or other industrial or intellectual property rights.

Export control — This document as well as the item(s) described herein may be subject to export control regulations. Export might require a prior authorization from competent authorities.

Non-automotive qualified products — Unless this data sheet expressly states that this specific Nexperia product is automotive qualified, the product is not suitable for automotive use. It is neither qualified nor tested in accordance with automotive testing or application requirements. Nexperia accepts no liability for inclusion and/or use of non-automotive qualified products in automotive equipment or applications.

In the event that customer uses the product for design-in and use in automotive applications to automotive specifications and standards, customer (a) shall use the product without Nexperia's warranty of the product for such automotive applications, use and specifications, and (b) whenever customer uses the product for automotive applications beyond Nexperia's specifications such use shall be solely at customer's own risk, and (c) customer fully indemnifies Nexperia for any liability, damages or failed product claims resulting from customer design and use of the product for automotive applications beyond Nexperia's standard warranty and Nexperia's product specifications.

Translations — A non-English (translated) version of a document is for reference only. The English version shall prevail in case of any discrepancy between the translated and English versions.

Trademarks

Notice: All referenced brands, product names, service names and trademarks are the property of their respective owners.

Contents

1. General description	1
2. Features and benefits	1
3. Applications	1
4. Ordering information	2
5. Marking	2
6. Functional diagram	2
7. Pinning information	3
7.1. Pinning.....	3
7.2. Pin description.....	3
8. Device comparison	4
9. Limiting values	4
10. Recommended operating conditions	4
11. Thermal Information	5
12. Electrical characteristics	5
13. Typical characteristics	6
14. Detailed description	14
14.1. Overview.....	14
14.2. Function block diagram.....	14
14.3. Feature description.....	14
14.3.1. Undervoltage lockout (UVLO).....	14
14.3.2. Thermal shutdown.....	14
14.3.3. Boost converter.....	15
14.3.4. LDO regulator.....	15
14.3.5. Negative charge pump.....	16
14.4. I ² C interface.....	16
14.5. Register configuration.....	17
15. Package outline	18
16. Abbreviations	19
17. Revision history	19
18. Legal information	20

© Nexperia B.V. 2025. All rights reserved

For more information, please visit: <http://www.nexperia.com>
 For sales office addresses, please send an email to: salesaddresses@nexperia.com
 Date of release: 5 March 2025