

SPECIFICATIONS FOR NICHIA CHIP TYPE WHITE LED

MODEL : NFSW072T

NICHIA CORPORATION

1.SPECIFICATIONS

(1) Absolute Maximum Ratings (Ts=25°C)

Item	Symbol	Absolute Maximum Rating	Unit
Forward Current	IF	250	mA
Pulse Forward Current	IFP	350	mA
Allowable Reverse Current	IR	85	mA
Power Dissipation	PD	950	mW
Operating Temperature	T _{opr}	-40 ~ +100	°C
Storage Temperature	T _{stg}	-40 ~ +100	°C
Dice Temperature	T _j	150	°C
Soldering Temperature	T _{sld}	Reflow Soldering : 260°C for 10sec. Hand Soldering : 350°C for 3sec.	

IFP Conditions : Pulse Width \leq 10msec. and Duty \leq 1/10

(2) Initial Electrical/Optical Characteristics (Ts=25°C)

Item	Symbol	Condition	Typ.	Max.	Unit
Forward Voltage	V _F	I _F =150[mA]	(3.5)	3.8	V
Luminous Flux	ϕ_v	I _F =150[mA]	(20)	-	lm
Chromaticity Coordinate	x	I _F =150[mA]	0.31	-	-
	y	I _F =150[mA]	0.32	-	-

* Please refer to CIE 1931 chromaticity diagram.

(3) Ranking (Ts=25°C)

Item	Symbol	Condition	Min.	Max.	Unit
Luminous Flux	Rank P9	I _F =150[mA]	21.4	25.5	lm
	Rank P8		18.0	21.4	
	Rank P7		15.1	18.0	
	Rank P6		12.7	15.1	

* Luminous Flux Measurement allowance is \pm 7%.

Color Ranks

(I_F=150mA, Ts=25°C)

	Rank b3			
x	0.287	0.283	0.304	0.307
y	0.295	0.305	0.330	0.315

	Rank b4			
x	0.307	0.304	0.330	0.330
y	0.315	0.330	0.360	0.339

	Rank b5			
x	0.296	0.287	0.307	0.311
y	0.276	0.295	0.315	0.294

	Rank b6			
x	0.311	0.307	0.330	0.330
y	0.294	0.315	0.339	0.318

	Rank c1			
x	0.330	0.330	0.361	0.357
y	0.339	0.360	0.385	0.361

	Rank c2			
x	0.330	0.330	0.357	0.356
y	0.318	0.339	0.361	0.351

* Color Coordinates Measurement allowance is \pm 0.01.

2.INITIAL OPTICAL/ELECTRICAL CHARACTERISTICS

Please refer to figure's page.

3.OUTLINE DIMENSIONS AND MATERIALS

Please refer to figure's page.

Material as follows ;	Package	:	Ceramics
	Encapsulating Resin	:	Silicone Resin (with Diffused + Phosphor)
	Electrodes	:	Au Plating

4.PACKAGING

- The LEDs are packed in cardboard boxes after taping.

Please refer to figure's page.

The label on the minimum packing unit shows ; Part Number, Lot Number, Ranking, Quantity

- In order to protect the LEDs from mechanical shock, we pack them in cardboard boxes for transportation.
- The LEDs may be damaged if the boxes are dropped or receive a strong impact against them, so precautions must be taken to prevent any damage.
- The boxes are not water resistant and therefore must be kept away from water and moisture.
- When the LEDs are transported, we recommend that you use the same packing method as Nichia.

5.LOT NUMBER

The first six digits number shows **lot number**.

The lot number is composed of the following characters;

○□×××× - △■

- - Year (6 for 2006, 7 for 2007)
- - Month (1 for Jan., 9 for Sep., A for Oct., B for Nov.)
- ×××× - Nichia's Product Number
- △ - Ranking by Color Coordinates
- - Ranking by Luminous Flux

6.RELIABILITY

(1) TEST ITEMS AND RESULTS

Test Item	Standard Test Method	Test Conditions	Note	Number of Damaged
Resistance to Soldering Heat (Reflow Soldering)	JEITA ED-4701 300 301	Tsld=260°C, 10sec. (Pre treatment 30°C,70%,168hrs.)	2 times	0/22
Solderability (Reflow Soldering)	JEITA ED-4701 300 303	Tsld=215 ± 5°C, 3sec. (Lead Solder)	1 time over 95%	0/22
Thermal Shock	JEITA ED-4701 300 307	-40°C ~ 100°C 1min. (10sec.) 1min. (Pre treatment 30°C,70%,168hrs.)	100 cycles	0/50
Temperature Cycle	JEITA ED-4701 100 105	-40°C ~ 25°C ~ 100°C ~ 25°C 30min. 5min. 30min. 5min.	100 cycles	0/50
Moisture Resistance Cyclic	JEITA ED-4701 200 203	25°C ~ 65°C ~ -10°C 90%RH 24hrs./1cycle	10 cycles	0/50
High Temperature Storage	JEITA ED-4701 200 201	Ta=100°C	1000 hrs.	0/50
Temperature Humidity Storage	JEITA ED-4701 100 103	Ta=60°C, RH=90%	1000 hrs.	0/50
Low Temperature Storage	JEITA ED-4701 200 202	Ta=-40°C	1000 hrs.	0/50
Steady State Operating Life		Ta=25°C, IF=250mA Tested with Nichia standard circuit board.*	1000 hrs.	0/50
Steady State Operating Life of High Temperature		Ta=100°C, IF=120mA Tested with Nichia standard circuit board.*	1000 hrs.	0/50
Steady State Operating Life of High Humidity Heat		60°C, RH=90%, IF=200mA Tested with Nichia standard circuit board.*	1000 hrs.	0/50
Steady State Operating Life of Low Temperature		Ta=-40°C, IF=150mA Tested with Nichia standard circuit board.*	1000 hrs.	0/50
Permanence of Marking	JEITA ED-4701 500 501	Solvent : Isopropyl Alcohol Solvent Temperature : 20 ~ 25°C Dipping Time : 5 min.	1 time	0/22
Vibration	JEITA ED-4701 400 403	100 ~ 2000 ~ 100Hz Sweep 4min. 200m/s ² 3directions, 4cycles	48min.	0/10
Electrostatic Discharges	JEITA ED-4701 300 304	R=1.5kΩ, C=100pF Test Voltage=2kV	3 times Negative/Positive	0/22

* Thermal resistance of LED with Nichia standard circuit board : $R_{ja} \cong 110^{\circ}\text{C}/\text{W}$

Nichia standard circuit board : FR4, t=1.6mm, Copper foil, t=0.07mm

(2) CRITERIA FOR JUDGING DAMAGE

Item	Symbol	Test Conditions	Criteria for Judgement	
			Min.	Max.
Forward Voltage	V _F	I _F =150mA	-	Initial Level × 1.1
Luminous Flux	φ _v	I _F =150mA	Initial Level × 0.7	-

* The test is performed after the board is cooled down to the room temperature.

7.CAUTIONS

The LEDs are devices which are materialized by combining Blue LEDs and special phosphors. Consequently, the color of the LEDs is changed a little by an operating current. Care should be taken after due consideration when using LEDs.

(1) Moisture Proof Package

- When moisture is absorbed into the SMT package it may vaporize and expand during soldering. There is a possibility that this can cause exfoliation of the contacts and damage the optical characteristics of the LEDs. For this reason, the moisture proof package is used to keep moisture to a minimum in the package.
- The moisture proof package is made of an aluminum moisture proof bag. A package of a moisture absorbent material (silica gel) is inserted into the aluminum moisture proof bag. The silica gel changes its color from blue to pink as it absorbs moisture.

(2) Storage

· Storage Conditions

Before opening the package :

The LEDs should be kept at 30°C or less and 90%RH or less. The LEDs should be used within a year. When storing the LEDs, moisture proof packaging with absorbent material (silica gel) is recommended.

After opening the package :

The LEDs should be kept at 30°C or less and 70%RH or less. The LEDs should be soldered within 168 hours (7days) after opening the package. If unused LEDs remain, they should be stored in the moisture proof packages, such as sealed containers with packages of moisture absorbent material (silica gel). It is also recommended to return the LEDs to the original moisture proof bag and to reseal the moisture proof bag again.

- If the moisture absorbent material (silica gel) has faded away or the LEDs have exceeded the storage time, baking treatment should be performed using the following condition.
Baking treatment : more than 24 hours at $65 \pm 5^\circ\text{C}$
- Nichia LED electrodes are gold plated. The gold surface may be affected by environments which contain corrosive substances. Please avoid conditions which may cause the LED to corrode, tarnish or discolor. This corrosion or discoloration may cause difficulty during soldering operations. It is recommended that the User use the LEDs as soon as possible.
- Please avoid rapid transitions in ambient temperature, especially in high humidity environments where condensation can occur.

(3) Static Electricity

- Static electricity or surge voltage damages the LEDs.
It is recommended that a wrist band or an anti-electrostatic glove be used when handling the LEDs.
- All devices, equipment and machinery must be properly grounded. It is recommended that precautions be taken against surge voltage to the equipment that mounts the LEDs.
- When inspecting the final products in which LEDs were assembled, it is recommended to check whether the assembled LEDs are damaged by static electricity or not. It is easy to find static-damaged LEDs by a light-on test or a VF test at a lower current (below 1mA is recommended).
- Damaged LEDs will show some unusual characteristics such as the forward voltage becomes lower, or the LEDs do not light at the low current.

Criteria : (VF > 2.0V at IF=0.5mA)

(4) Designing the position of LED on a board.

- No twist / warp / bent / or other stress shall be applied to the board after mounting LED with solder to avoid a crack of LED package.

Refer to the following recommended position and direction of LED.

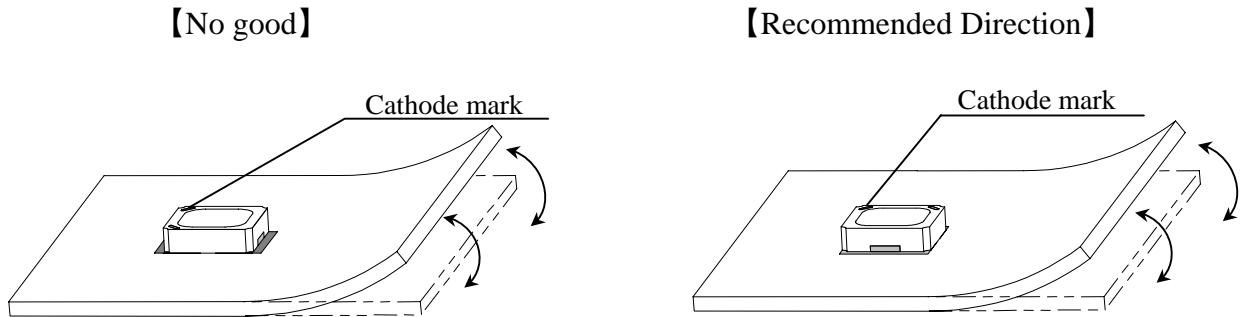

Appropriate LED mounting is to place perpendicularly against the stress affected side.

- Depending on the position and direction of LED, the mechanical stress on the LED package can be changed. Refer to the following figure.

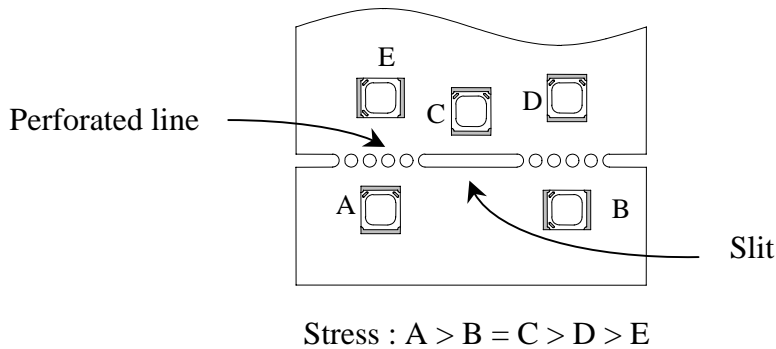

- Do not split board by hand. Split with exclusive special tool.
- If an aluminum circuit board is used, a large stress by thermal shock might cause a solder crack. For this reason, it is recommended an appropriate verification should be taken before use.

(5) Soldering Conditions

- The LEDs can be soldered in place using the reflow soldering method. Nichia cannot make a guarantee on the LEDs after they have been assembled using the dip soldering method.
- Recommended soldering conditions

	Reflow Soldering		Hand Soldering	
	Lead Solder	Lead-free Solder	Temperature	Soldering time
Pre-heat	120 ~ 150°C	180 ~ 200°C	350°C Max. 3 sec. Max. (one time only)	350°C Max. 3 sec. Max. (one time only)
Pre-heat time	120 sec. Max.	120 sec. Max.		
Peak temperature	240°C Max.	260°C Max.		
Soldering time	10 sec. Max.	10 sec. Max.		
Condition	refer to Temperature - profile ①.	refer to Temperature - profile ②. (N ₂ reflow is recommended.)		

* Although the recommended soldering conditions are specified in the above table, reflow or hand soldering at the lowest possible temperature is desirable for the LEDs.

* A rapid-rate process is not recommended for cooling the LEDs down from the peak temperature. [Temperature-profile (Surface of circuit board)] Use the conditions shown to the under figure.

<① : Lead Solder>

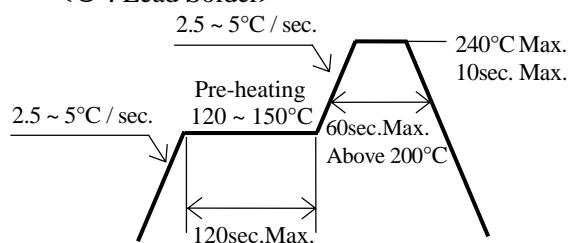

[Recommended soldering pad design]

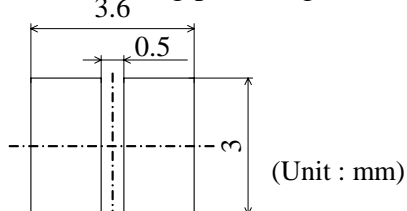

<② : Lead-free Solder>

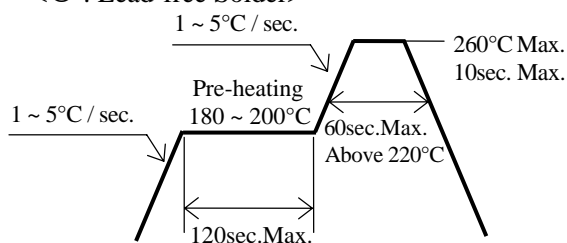

Use the following conditions shown in the figure.

- Occasionally there is a brightness decrease caused by the influence of heat or ambient atmosphere during air reflow. It is recommended that the User use the nitrogen reflow method.
- The encapsulated material of the LEDs is silicone. Therefore the LEDs have a soft surface on the top of package. The pressure to the top surface will be influence to the reliability of the LEDs. Precautions should be taken to avoid the strong pressure on the encapsulated part. So when using the chip mounter, the picking up nozzle that does not affect the silicone resin should be used.
- Repairing should not be done after the LEDs have been soldered. When repairing is unavoidable, a double-head soldering iron should be used. It should be confirmed beforehand whether the characteristics of the LEDs will or will not be damaged by repairing.
- Reflow soldering should not be done more than two times.
- When soldering, do not put stress on the LEDs during heating.

(6) Cleaning

- It is recommended that isopropyl alcohol be used as a solvent for cleaning the LEDs. When using other solvents, it should be confirmed beforehand whether the solvents will dissolve the package and the resin or not. Freon solvents should not be used to clean the LEDs because of worldwide regulations.
- Do not clean the LEDs by the ultrasonic. When it is absolutely necessary, the influence of ultrasonic cleaning on the LEDs depends on factors such as ultrasonic power and the assembled condition. Before cleaning, a pre-test should be done to confirm whether any damage to the LEDs will occur.

(7) Heat Generation

- Thermal design of the end product is of paramount importance. Please consider the heat generation of the LED when making the system design. The coefficient of temperature increase per input electric power is affected by the thermal resistance of the circuit board and density of LED placement on the board, as well as other components. It is necessary to avoid intense heat generation and operate within the maximum ratings given in this specification.
- Please determine the operating current with consideration of the ambient temperature local to the LED and refer to the plot of Ambient temperature vs. Allowable Forward Current on CHARACTERISTICS in this specifications. Please also take measures to remove heat from the area near the LED to improve the operational characteristics of the LED.
- The equation ① indicates correlation between T_j and T_a , and the equation ② indicates correlation between T_j and T_s .

$$T_j = T_a + R_{ja} \cdot W \quad \text{..... ①} \qquad T_j = T_s + R_{js} \cdot W \quad \text{..... ②}$$

* T_j = Dice Temperature : °C, T_a = Ambient Temperature : °C,

T_s = Solder Temperature (Cathode Side) : °C,

R_{ja} = Heat resistance from Dice to Ambient temperature : °C /W,

R_{js} = Heat resistance from Dice to T_s measuring point \cong 45°C /W,

W = Inputting Power ($I_F \times V_F$) : W

(8) Others

- NFSW072 complies with RoHS Directive.
- The LED light output is strong enough to injure human eyes. Precautions must be taken to prevent looking directly at the LEDs with unaided eyes for more than a few seconds.
- Flashing lights have been known to cause discomfort in people; you can prevent this by taking precautions during use. Also, people should be cautious when using equipment that has had LEDs incorporated into it.
- The LEDs described in this brochure are intended to be used for ordinary electronic equipment (such as office equipment, communications equipment, measurement instruments and household appliances). Consult Nichia's sales staff in advance for information on the applications in which exceptional quality and reliability are required, particularly when the failure or malfunction of the LEDs may directly jeopardize life or health (such as for airplanes, aerospace, submersible repeaters, nuclear reactor control systems, automobiles, traffic control equipment, life support systems and safety devices).
- User shall not reverse engineer by disassembling or analysis of the LEDs without having prior written consent from Nichia. When defective LEDs are found, the User shall inform Nichia directly before disassembling or analysis.
- The formal specifications must be exchanged and signed by both parties before large volume purchase begins.
- The appearance and specifications of the product may be modified for improvement without notice.

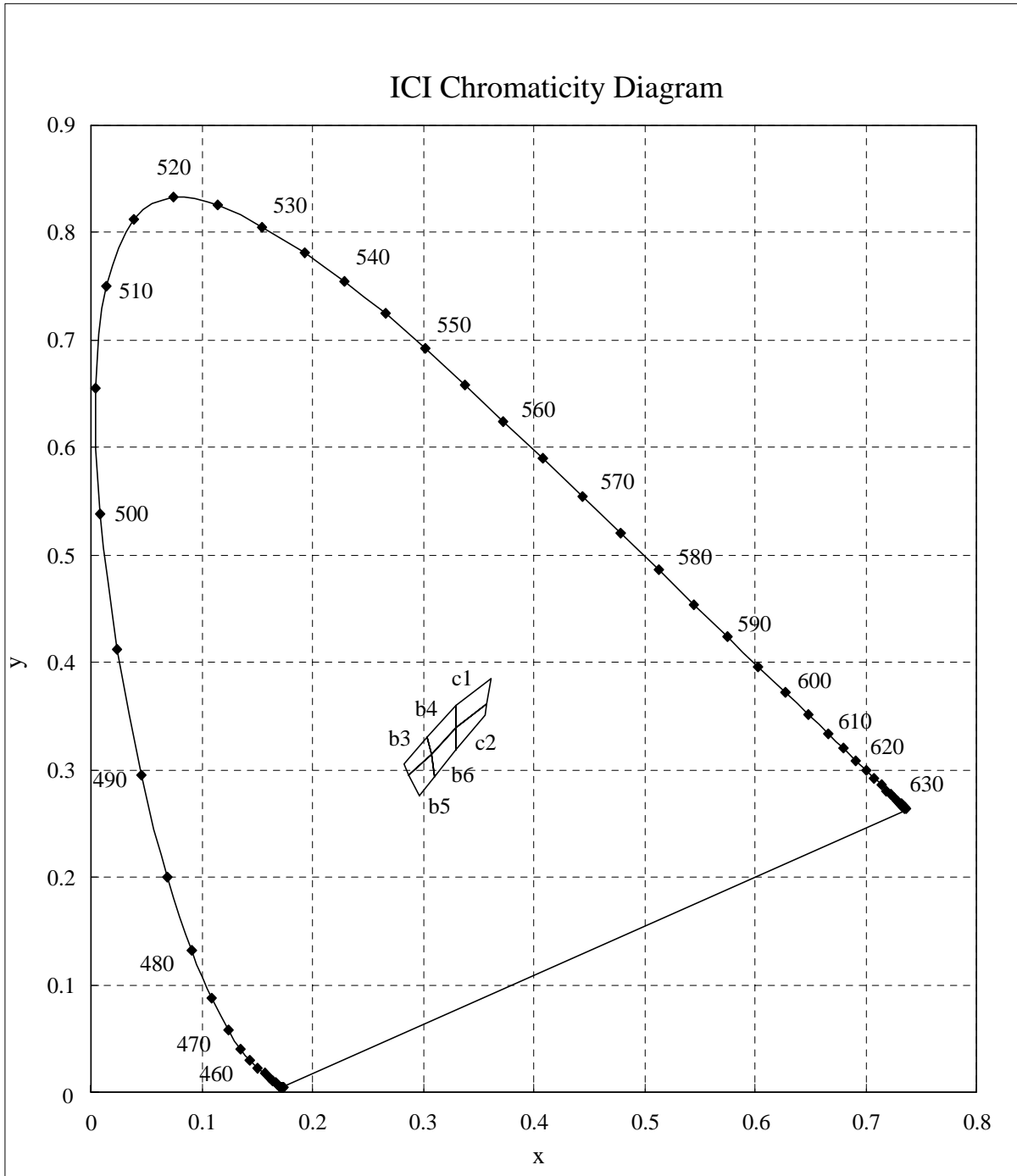

* Color Coordinates Measurement allowance is ± 0.01 .

■ Forward Voltage vs. Forward Current

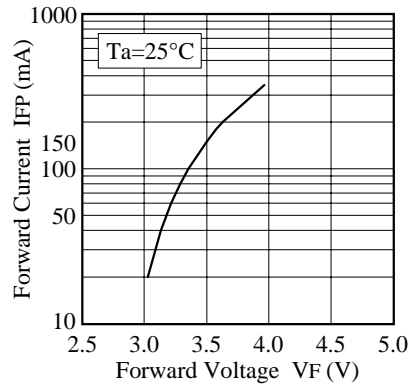

■ Forward Current vs. Relative Luminous Flux

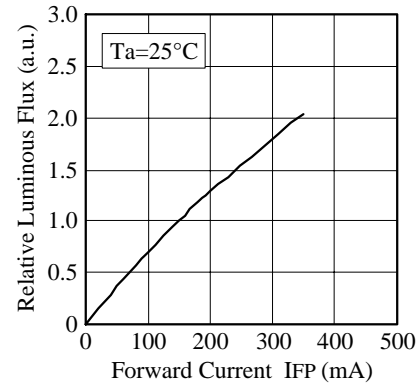

■ Duty Ratio vs. Allowable Forward Current

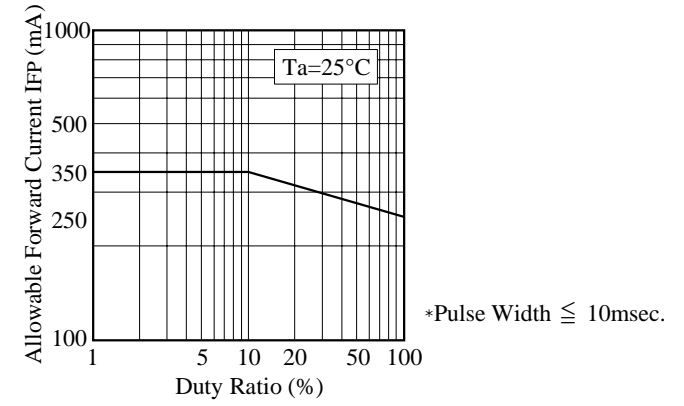

■ Ambient Temperature vs. Forward Voltage

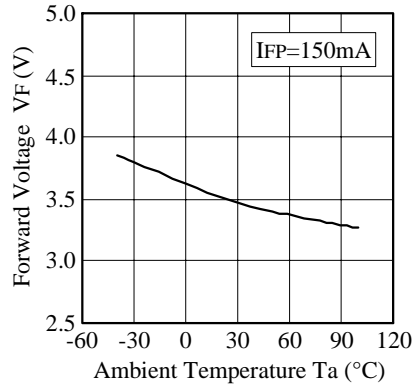

■ Ambient Temperature vs. Relative Luminous Flux

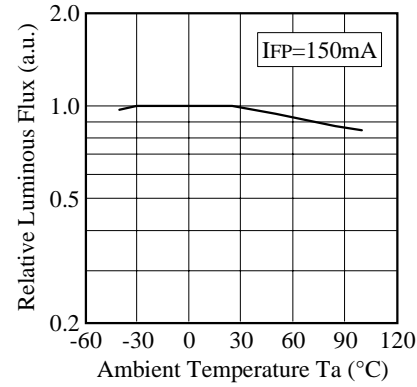

■ Ambient Temperature vs. Allowable Forward Current

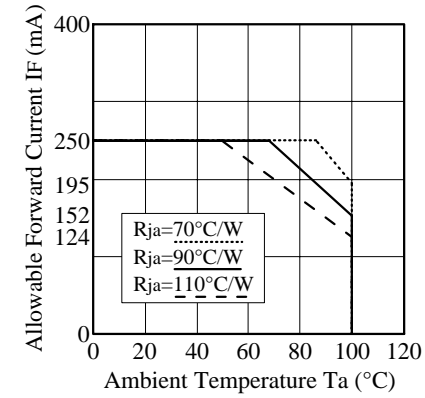

NICHIA CORPORATION	Model	NFSW072
	Title	CHARACTERISTICS
	No.	070402763181

■ Forward Current vs. Chromaticity Coordinate

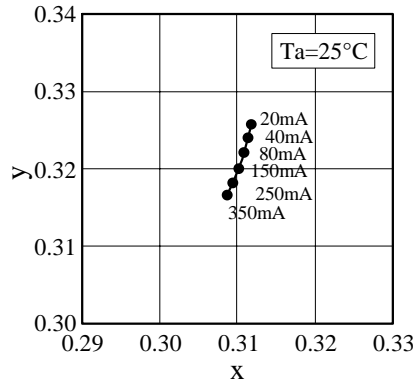

■ Spectrum

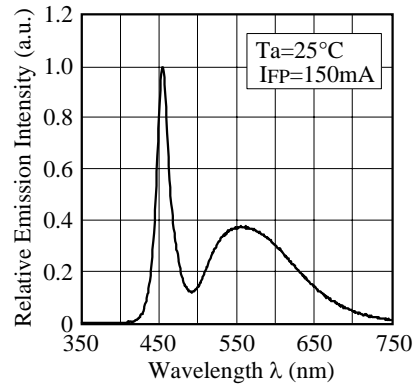

■ Ambient Temperature vs. Chromaticity Coordinate

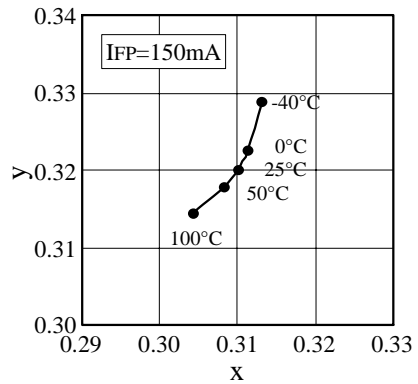

■ Directivity

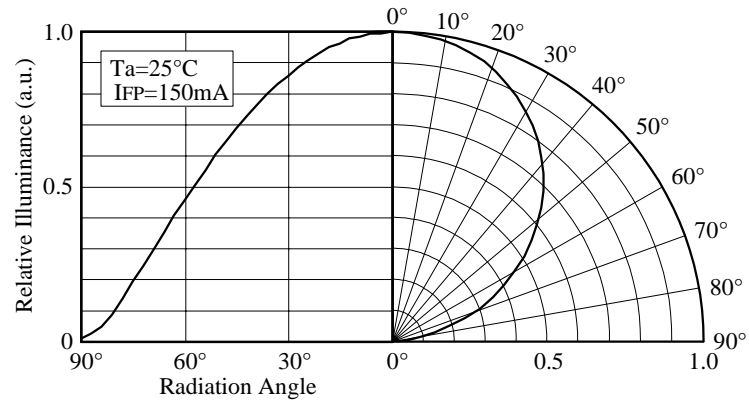

NICHIA CORPORATION	Model	NFSW072
	Title	CHARACTERISTICS
	No.	070402763191

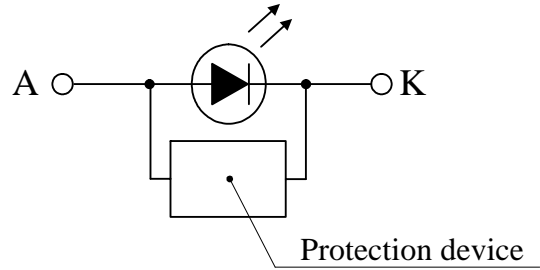
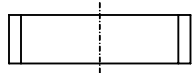
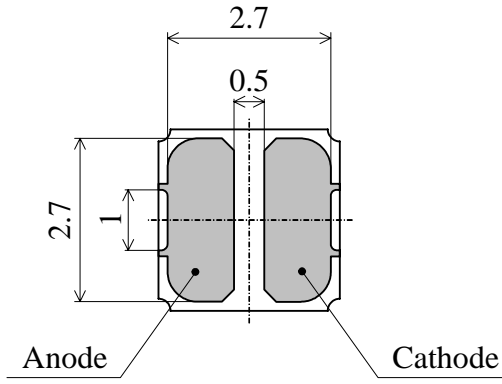
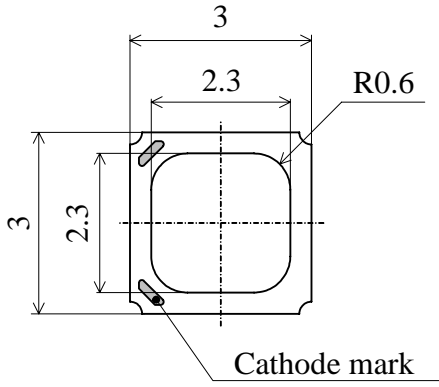

ITEM	MATERIALS
PACKAGE	Ceramics
ENCAPSULATING RESIN	Silicone Resin (with Diffused + Phosphor)
ELECTRODES	Au Plating

* NxSW072 has a protection device built in as a protection circuit against static electricity.

NICHIA CORPORATION	Model	NxSW072	Unit mm 8/1 Scale
	Title	OUTLINE DIMENSIONS	
	No.	070402763201	Allow ±0.2

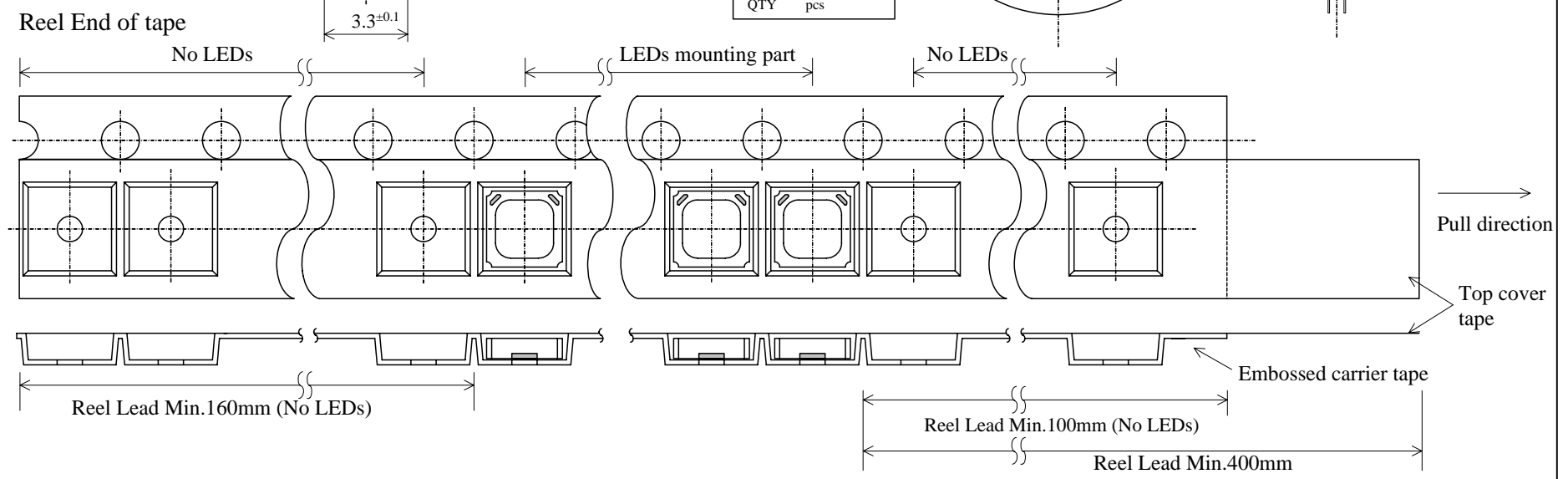
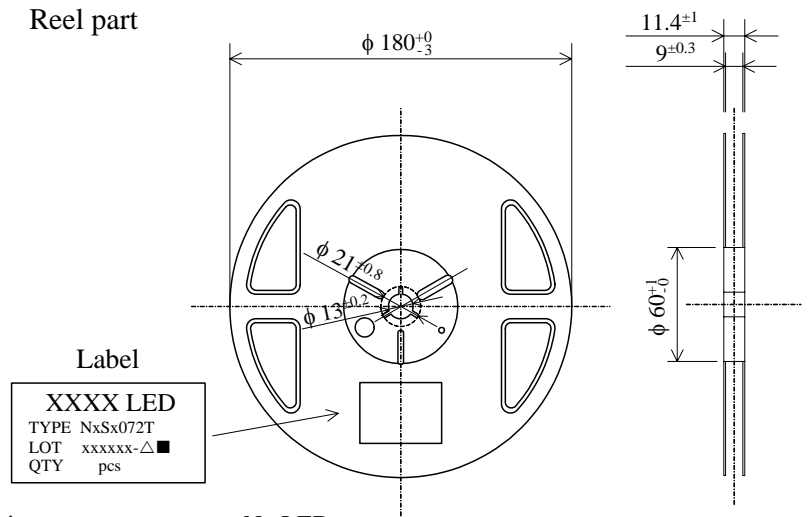
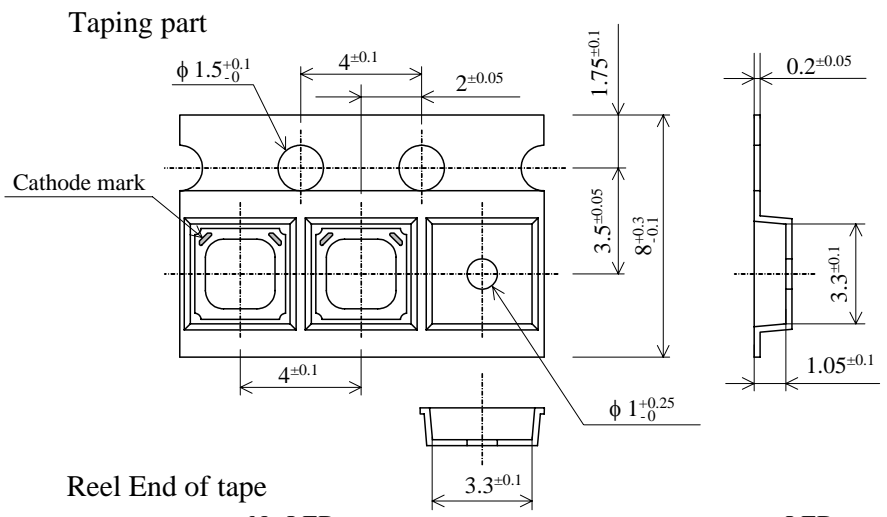

4,000pcs/Reel

Taping is based on the **JIS C 0806** : Packaging of Electronic Components on Continuous Tapes.

NICHIA CORPORATION	Model	NxSx072T	Unit mm
	Title	TAPING DIMENSIONS	
	No.	070409763211	Scale Allow

The reel and moisture absorbent material are put in the moisture proof foil bag and then heat sealed.

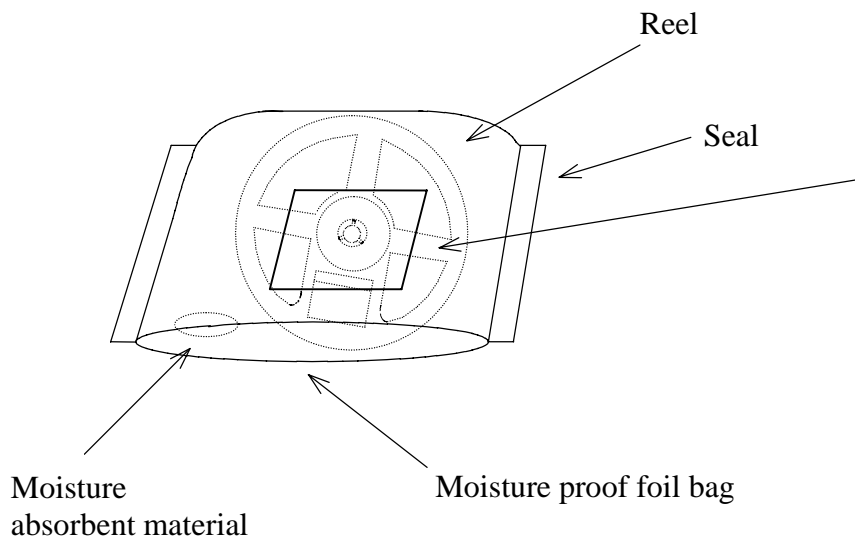

Label

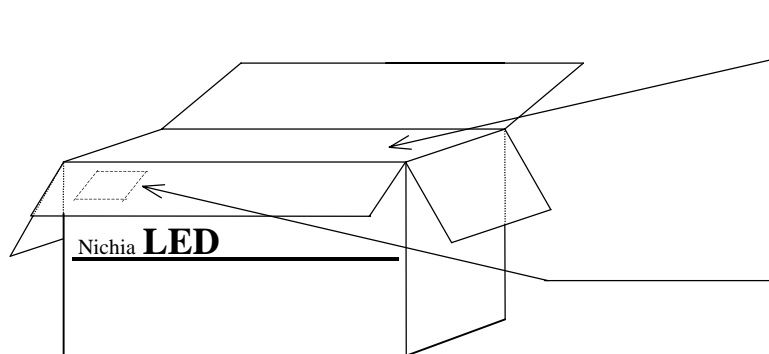
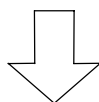

The box is partitioned with the cardboard.

Label

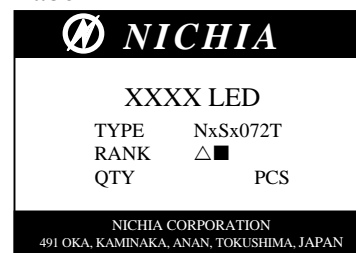

Packing unit

	Reel/bag	Quantity/bag (pcs)
Moisture proof foil bag	1reel	4,000 MAX.

Cardboard box	Dimensions (mm)	Reel/box	Quantity/box (pcs)
Cardboard box S	291×237×120×8t	7reel MAX.	28,000 MAX.
Cardboard box M	259×247×243×5t	15reel MAX.	60,000 MAX.
Cardboard box L	444×262×259×8t	30reel MAX.	120,000 MAX.

NICHIA CORPORATION	Model	NxSx072T	/
	Title	PACKING	
	No.	070409763221	