

# NGD18N40CLB, NGD18N40ACLB

## Ignition IGBT, 18 A, 400 V N-Channel DPAK

This Logic Level Insulated Gate Bipolar Transistor (IGBT) features monolithic circuitry integrating ESD and Over-Voltage clamped protection for use in inductive coil drivers applications. Primary uses include Ignition, Direct Fuel Injection, or wherever high voltage and high current switching is required.

### Features

- Ideal for Coil-on-Plug Applications
- DPAK Package Offers Smaller Footprint for Increased Board Space
- Gate-Emitter ESD Protection
- Temperature Compensated Gate-Collector Voltage Clamp Limits Stress Applied to Load
- Integrated ESD Diode Protection
- New Design Increases Unclamped Inductive Switching (UIS) Energy Per Area
- Low Threshold Voltage Interfaces Power Loads to Logic or Microprocessor Devices
- Low Saturation Voltage
- High Pulsed Current Capability
- Optional Gate Resistor ( $R_G$ ) and Gate-Emitter Resistor ( $R_{GE}$ )
- Emitter Ballasting for Short-Circuit Capability
- These are Pb-Free Devices

### MAXIMUM RATINGS ( $T_J = 25^\circ\text{C}$ unless otherwise noted)

Rating	Symbol	Value	Unit
Collector-Emitter Voltage	$V_{CES}$	430	$V_{DC}$
Collector-Gate Voltage	$V_{CER}$	430	$V_{DC}$
Gate-Emitter Voltage	$V_{GE}$	18	$V_{DC}$
Collector Current-Continuous @ $T_C = 25^\circ\text{C}$ - Pulsed	$I_C$	15 50	$A_{DC}$ $A_{AC}$
ESD (Human Body Model) $R = 1500 \Omega$ , $C = 100 \text{ pF}$	ESD	8.0	kV
ESD (Machine Model) $R = 0 \Omega$ , $C = 200 \text{ pF}$	ESD	800	V
Total Power Dissipation @ $T_C = 25^\circ\text{C}$ Derate above $25^\circ\text{C}$	$P_D$	115 0.77	Watts $\text{W}/^\circ\text{C}$
Operating and Storage Temperature Range	$T_J$ , $T_{stg}$	-55 to +175	$^\circ\text{C}$

Stresses exceeding those listed in the Maximum Ratings table may damage the device. If any of these limits are exceeded, device functionality should not be assumed, damage may occur and reliability may be affected.

\*For additional information on our Pb-Free strategy and soldering details, please download the ON Semiconductor Soldering and Mounting Techniques Reference Manual, SOLDERRM/D.

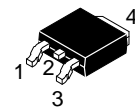
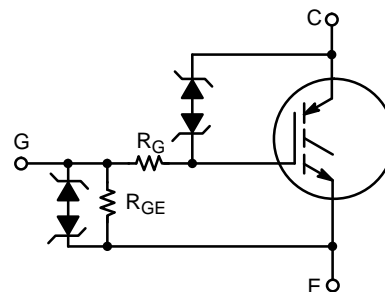


ON Semiconductor®

[www.onsemi.com](http://www.onsemi.com)

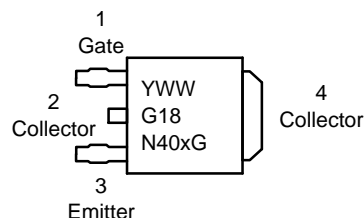
**18 AMPS, 400 VOLTS**

$V_{CE(on)} \leq 2.0 \text{ V @}$   
 $I_C = 10 \text{ A}, V_{GE} \geq 4.5 \text{ V}$



DPAK  
CASE 369C  
STYLE 7

### MARKING DIAGRAM



G18N40x = Device Code

x = B or A

Y = Year

WW = Work Week

G = Pb-Free Device

### ORDERING INFORMATION

Device	Package	Shipping†
NGD18N40CLBT4G	DPAK (Pb-Free)	2500/Tape & Reel
NGD18N40ACLBT4G	DPAK (Pb-Free)	2500/Tape & Reel

†For information on tape and reel specifications, including part orientation and tape sizes, please refer to our Tape and Reel Packaging Specification Brochure, BRD8011/D.

# NGD18N40CLB, NGD18N40ACLB

## UNCLAMPED COLLECTOR-TO-EMITTER AVALANCHE CHARACTERISTICS ( $-55^{\circ} \leq T_J \leq 175^{\circ}C$ )

Characteristic	Symbol	Value	Unit
Single Pulse Collector-to-Emitter Avalanche Energy $V_{CC} = 50\text{ V}$ , $V_{GE} = 5.0\text{ V}$ , Pk $I_L = 21.1\text{ A}$ , $L = 1.8\text{ mH}$ , Starting $T_J = 25^{\circ}C$ $V_{CC} = 50\text{ V}$ , $V_{GE} = 5.0\text{ V}$ , Pk $I_L = 16.2\text{ A}$ , $L = 3.0\text{ mH}$ , Starting $T_J = 25^{\circ}C$ $V_{CC} = 50\text{ V}$ , $V_{GE} = 5.0\text{ V}$ , Pk $I_L = 18.3\text{ A}$ , $L = 1.8\text{ mH}$ , Starting $T_J = 125^{\circ}C$	$E_{AS}$	400 400 300	mJ
Reverse Avalanche Energy $V_{CC} = 100\text{ V}$ , $V_{GE} = 20\text{ V}$ , Pk $I_L = 25.8\text{ A}$ , $L = 6.0\text{ mH}$ , Starting $T_J = 25^{\circ}C$	$E_{AS(R)}$	2000	mJ

## MAXIMUM SHORT-CIRCUIT TIMES ( $-55^{\circ}C \leq T_J \leq 150^{\circ}C$ )

Short Circuit Withstand Time 1 (See Figure 17, 3 Pulses with 10 ms Period)	$t_{sc1}$	750	$\mu s$
Short Circuit Withstand Time 2 (See Figure 18, 3 Pulses with 10 ms Period)	$t_{sc2}$	5.0	ms

## THERMAL CHARACTERISTICS

Thermal Resistance, Junction to Case	$R_{\theta JC}$	1.3	$^{\circ}C/W$
Thermal Resistance, Junction to Ambient	$R_{\theta JA}$	95	$^{\circ}C/W$
Maximum Lead Temperature for Soldering Purposes, 1/8" from case for 5 seconds	$T_L$	275	$^{\circ}C$

## ELECTRICAL CHARACTERISTICS

Characteristic	Symbol	Test Conditions	Temperature	Min	Typ	Max	Unit
----------------	--------	-----------------	-------------	-----	-----	-----	------

### OFF CHARACTERISTICS

Collector-Emitter Clamp Voltage	$BV_{CES}$	$I_C = 2.0\text{ mA}$	$T_J = -40^{\circ}C$ to $150^{\circ}C$	380	395	420	$V_{DC}$
		$I_C = 10\text{ mA}$	$T_J = -40^{\circ}C$ to $150^{\circ}C$	390	405	430	
Zero Gate Voltage Collector Current	$I_{CES}$	$V_{CE} = 350\text{ V}$ , $V_{GE} = 0\text{ V}$	$T_J = 25^{\circ}C$	-	2.0	20	$\mu A_{DC}$
			$T_J = 150^{\circ}C$	-	10	40*	
			$T_J = -40^{\circ}C$	-	1.0	10	
Reverse Collector-Emitter Leakage Current	$I_{ECS}$	$V_{CE} = -24\text{ V}$	$T_J = 25^{\circ}C$	-	0.7	1.0	mA
			$T_J = 150^{\circ}C$	-	12	25*	
			$T_J = -40^{\circ}C$	-	0.1	1.0	
Reverse Collector-Emitter Clamp Voltage	$BV_{CES(R)}$	$I_C = -75\text{ mA}$	$T_J = 25^{\circ}C$	27	33	37	$V_{DC}$
			$T_J = 150^{\circ}C$	30	36	40	
			$T_J = -40^{\circ}C$	25	32	35	
Gate-Emitter Clamp Voltage	$BV_{GES}$	$I_G = 5.0\text{ mA}$	$T_J = -40^{\circ}C$ to $150^{\circ}C$	11	13	15	$V_{DC}$
Gate-Emitter Leakage Current	$I_{GES}$	$V_{GE} = 10\text{ V}$	$T_J = -40^{\circ}C$ to $150^{\circ}C$	384	640	700	$\mu A_{DC}$
Gate Resistor	$R_G$	-	$T_J = -40^{\circ}C$ to $150^{\circ}C$	-	70	-	$\Omega$
Gate Emitter Resistor	$R_{GE}$	-	$T_J = -40^{\circ}C$ to $150^{\circ}C$	10	16	26	k $\Omega$

Product parametric performance is indicated in the Electrical Characteristics for the listed test conditions, unless otherwise noted. Product performance may not be indicated by the Electrical Characteristics if operated under different conditions.

1. When surface mounted to an FR4 board using the minimum recommended pad size.

\*Maximum Value of Characteristic across Temperature Range.

# NGD18N40CLB, NGD18N40ACLB

## ELECTRICAL CHARACTERISTICS (continued)

Characteristic	Symbol	Test Conditions	Temperature	Min	Typ	Max	Unit
<b>ON CHARACTERISTICS (Note 2)</b>							
Gate Threshold Voltage	$V_{GE(th)}$	$I_C = 1.0 \text{ mA}$ , $V_{GE} = V_{CE}$	$T_J = 25^\circ\text{C}$	1.1	1.4	1.9	$V_{DC}$
			$T_J = 150^\circ\text{C}$	0.75	1.0	1.4	
			$T_J = -40^\circ\text{C}$	1.2	1.6	2.1*	
Threshold Temperature Coefficient (Negative)	-	-	-	-	3.4	-	mV/°C
Collector-to-Emitter On-Voltage	$V_{CE(on)}$	$I_C = 6.0 \text{ A}$ , $V_{GE} = 4.0 \text{ V}$	$T_J = 25^\circ\text{C}$	1.0	1.4	1.6	$V_{DC}$
			$T_J = 150^\circ\text{C}$	0.9	1.3	1.6	
			$T_J = -40^\circ\text{C}$	1.1	1.45	1.7*	
		$I_C = 8.0 \text{ A}$ , $V_{GE} = 4.0 \text{ V}$	$T_J = 25^\circ\text{C}$	1.3	1.6	1.9*	
			$T_J = 150^\circ\text{C}$	1.2	1.55	1.8	
			$T_J = -40^\circ\text{C}$	1.4	1.6	1.9*	
		$I_C = 10 \text{ A}$ , $V_{GE} = 4.0 \text{ V}$	$T_J = 25^\circ\text{C}$	1.4	1.8	2.05	
			$T_J = 150^\circ\text{C}$	1.4	1.8	2.0	
			$T_J = -40^\circ\text{C}$	1.4	1.8	2.1*	
		$I_C = 15 \text{ A}$ , $V_{GE} = 4.0 \text{ V}$	$T_J = 25^\circ\text{C}$	1.8	2.2	2.5	
			$T_J = 150^\circ\text{C}$	2.0	2.4	2.6*	
			$T_J = -40^\circ\text{C}$	1.7	2.1	2.5	
		$I_C = 10 \text{ A}$ , $V_{GE} = 4.5 \text{ V}$	$T_J = 25^\circ\text{C}$	1.3	1.8	2.0*	
			$T_J = 150^\circ\text{C}$	1.3	1.75	2.0*	
			$T_J = -40^\circ\text{C}$	1.4	1.8	2.0*	
$I_C = 6.5 \text{ A}$ , $V_{GE} = 3.7 \text{ V}$	$T_J = 25^\circ\text{C}$	-	-	1.65			
Forward Transconductance	gfs	$V_{CE} = 5.0 \text{ V}$ , $I_C = 6.0 \text{ A}$	$T_J = -40^\circ\text{C}$ to $150^\circ\text{C}$	8.0	14	25	Mhos

## DYNAMIC CHARACTERISTICS

Input Capacitance	$C_{ISS}$	$V_{CC} = 25 \text{ V}$ , $V_{GE} = 0 \text{ V}$ $f = 1.0 \text{ MHz}$	$T_J = -40^\circ\text{C}$ to $150^\circ\text{C}$	400	800	1000	pF
Output Capacitance	$C_{OSS}$			50	75	100	
Transfer Capacitance	$C_{RSS}$			4.0	7.0	10	

## SWITCHING CHARACTERISTICS

Turn-Off Delay Time (Resistive)	$t_{d(off)}$	$V_{CC} = 300 \text{ V}$ , $I_C = 6.5 \text{ A}$ $R_G = 1.0 \text{ k}\Omega$ , $R_L = 46 \Omega$	$T_J = 25^\circ\text{C}$	-	4.0	10	$\mu\text{Sec}$
Fall Time (Resistive)	$t_f$	$V_{CC} = 300 \text{ V}$ , $I_C = 6.5 \text{ A}$ $R_G = 1.0 \text{ k}\Omega$ , $R_L = 46 \Omega$	$T_J = 25^\circ\text{C}$	-	9.0	15	
Turn-On Delay Time	$t_{d(on)}$	$V_{CC} = 10 \text{ V}$ , $I_C = 6.5 \text{ A}$ $R_G = 1.0 \text{ k}\Omega$ , $R_L = 1.5 \Omega$	$T_J = 25^\circ\text{C}$	-	0.7	4.0	$\mu\text{Sec}$
Rise Time	$t_r$	$V_{CC} = 10 \text{ V}$ , $I_C = 6.5 \text{ A}$ $R_G = 1.0 \text{ k}\Omega$ , $R_L = 1.5 \Omega$	$T_J = 25^\circ\text{C}$	-	4.5	7.0	

2. Pulse Test: Pulse Width  $\leq 300 \mu\text{s}$ , Duty Cycle  $\leq 2\%$ .

\*Maximum Value of Characteristic across Temperature Range.

# NGD18N40CLB, NGD18N40ACLB

## TYPICAL ELECTRICAL CHARACTERISTICS (unless otherwise noted)

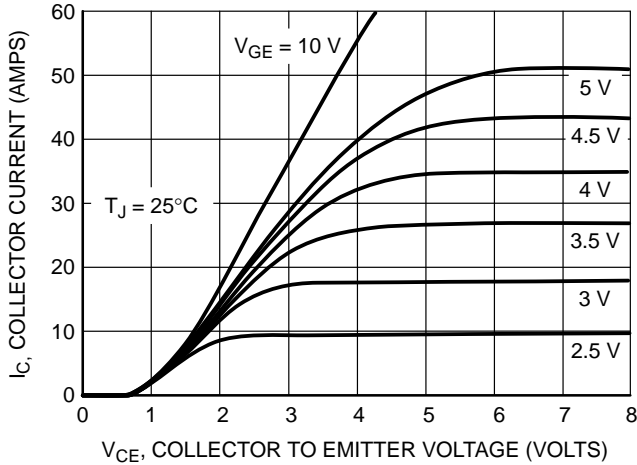


Figure 1. Output Characteristics

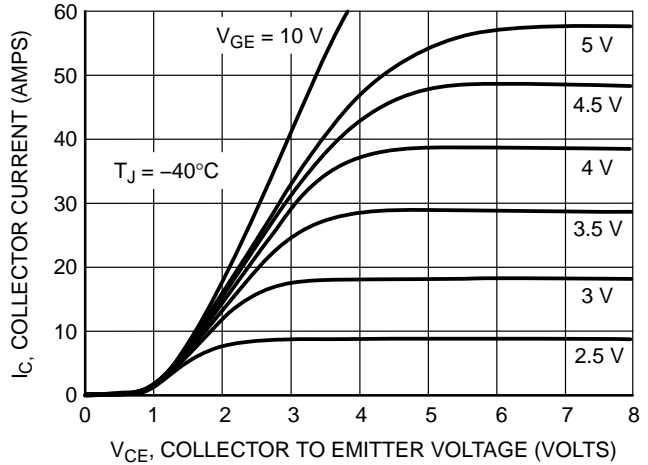


Figure 2. Output Characteristics

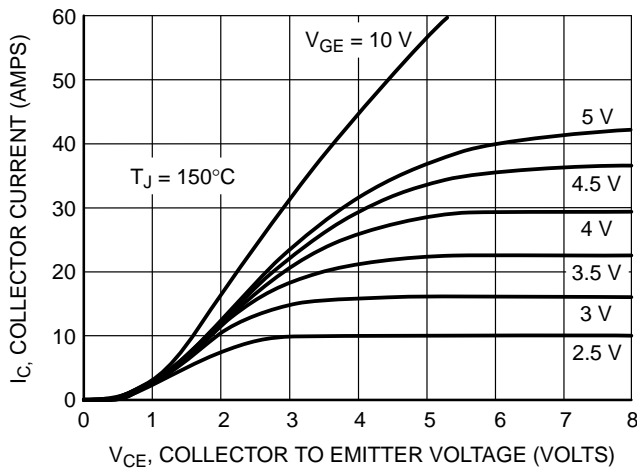


Figure 3. Output Characteristics

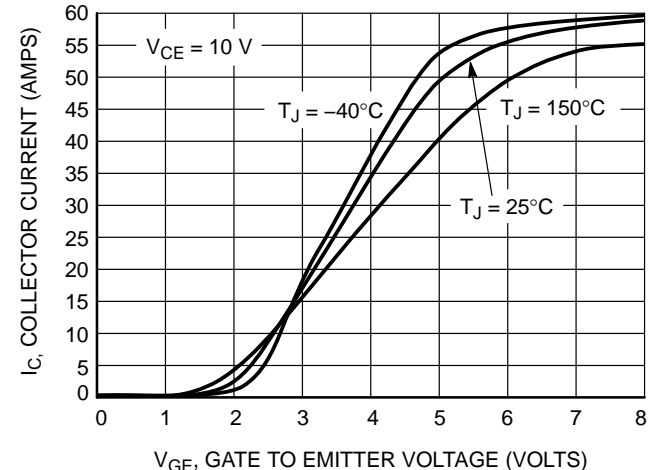


Figure 4. Transfer Characteristics

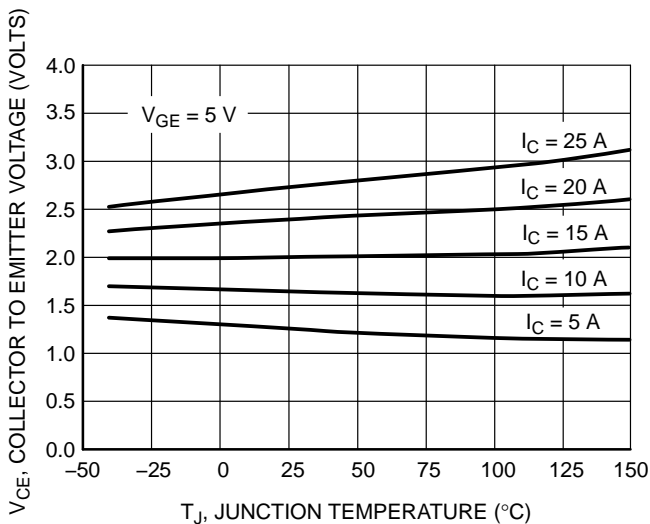


Figure 5. Collector-to-Emitter Saturation Voltage versus Junction Temperature

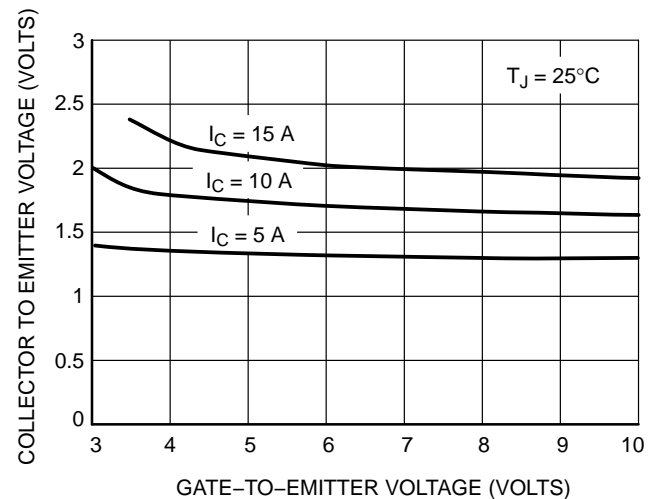
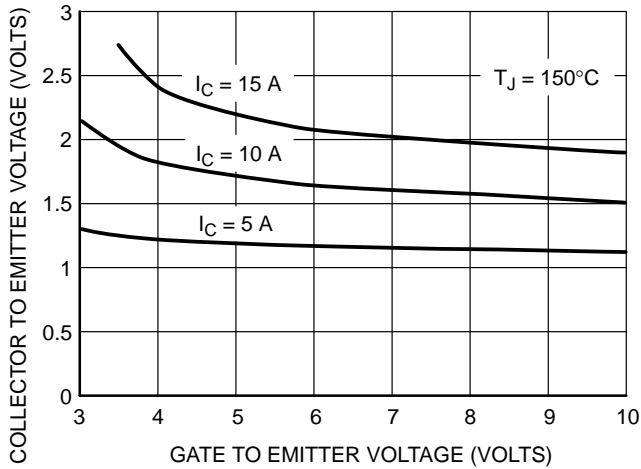


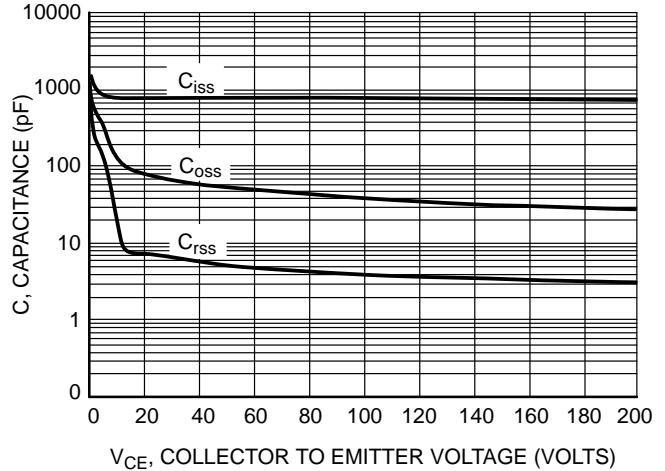
Figure 6. Collector-to-Emitter Voltage versus Gate-to-Emitter Voltage

# NGD18N40CLB, NGD18N40ACLB

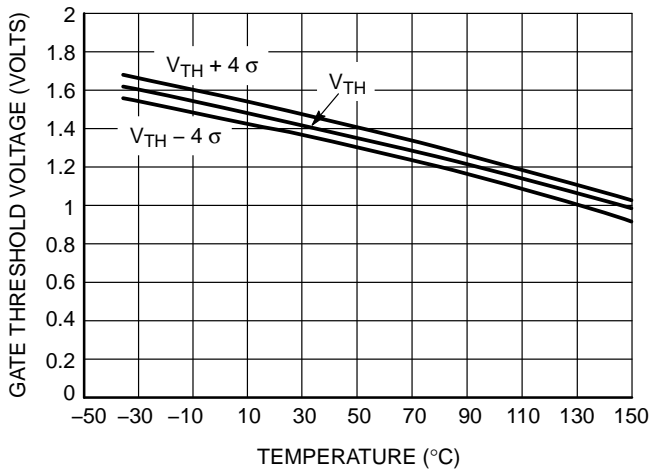
## TYPICAL ELECTRICAL CHARACTERISTICS (unless otherwise noted)



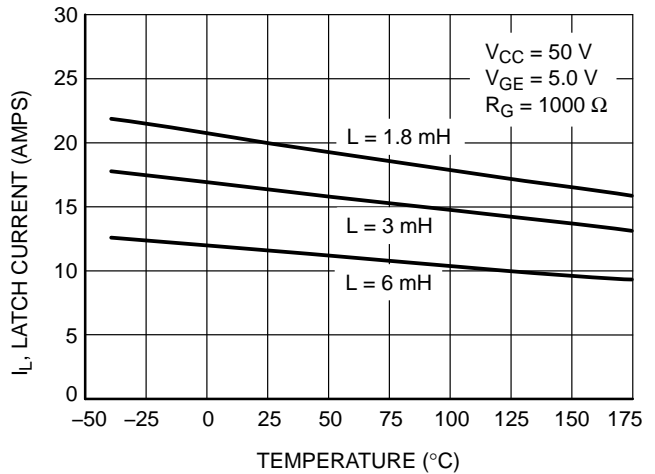
**Figure 7. Collector-to-Emitter Voltage versus Gate-to-Emitter Voltage**



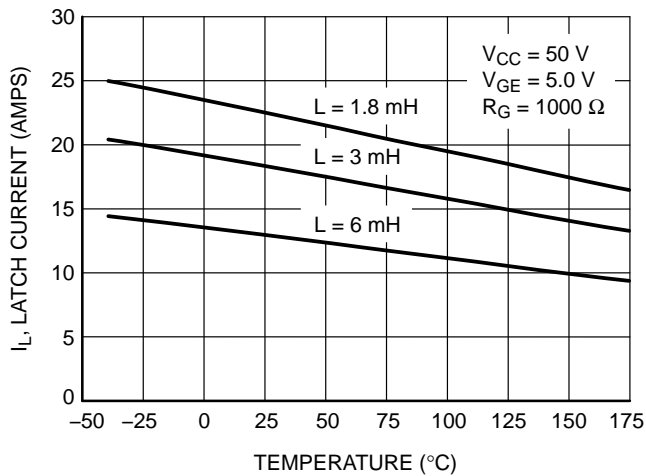
**Figure 8. Capacitance Variation**



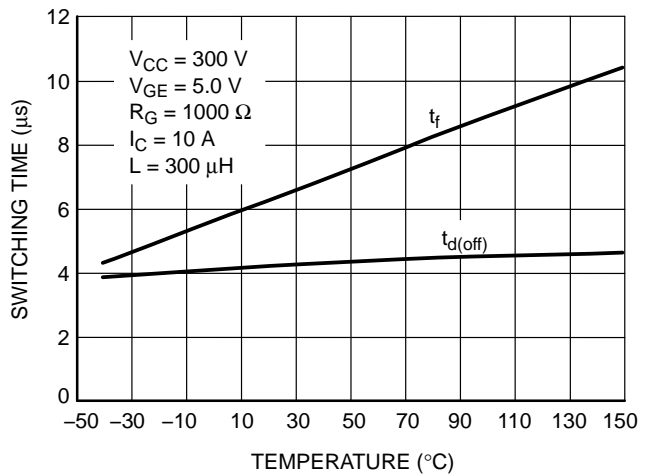
**Figure 9. Gate Threshold Voltage versus Temperature**



**Figure 10. Minimum Open Secondary Latch Current versus Temperature**

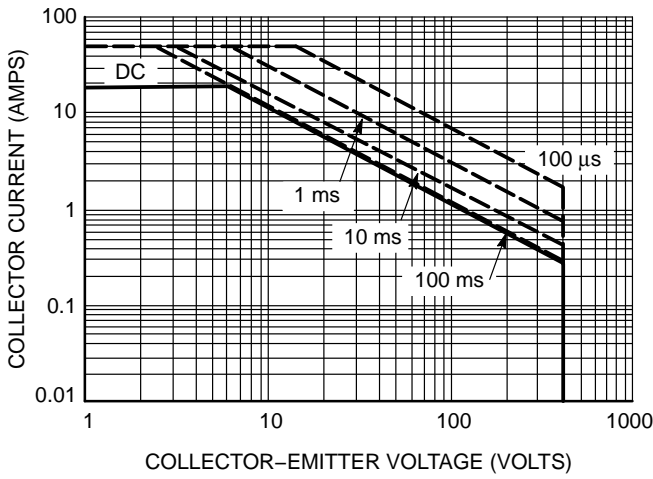


**Figure 11. Typical Open Secondary Latch Current versus Temperature**

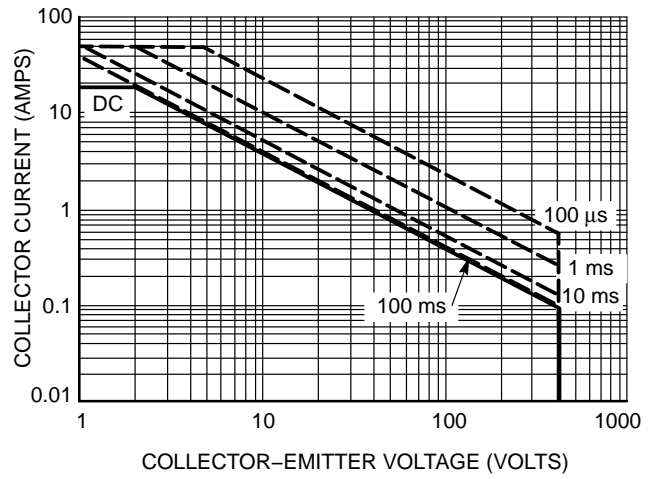


**Figure 12. Inductive Switching Fall Time versus Temperature**

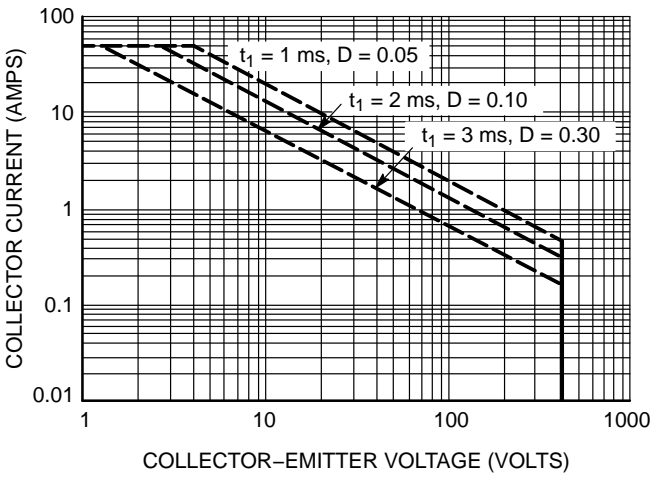
# NGD18N40CLB, NGD18N40ACLB



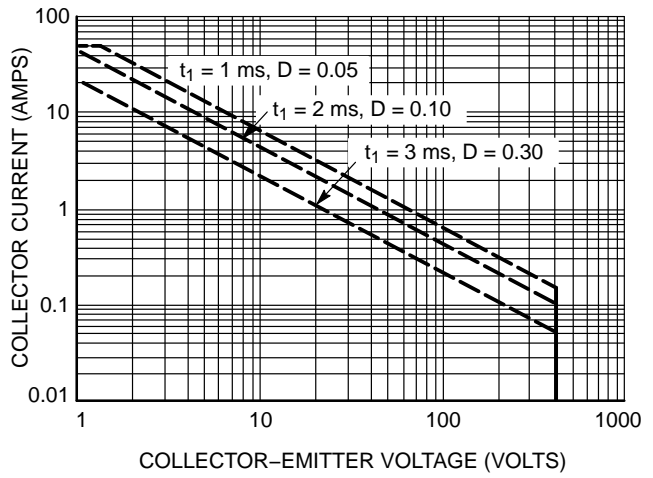
**Figure 13. Single Pulse Safe Operating Area (Mounted on an Infinite Heatsink at  $T_A = 25^\circ\text{C}$ )**



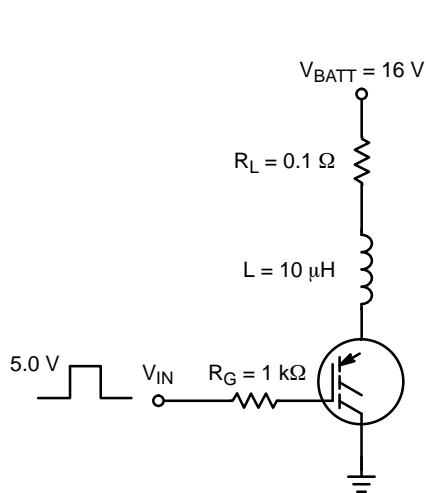
**Figure 14. Single Pulse Safe Operating Area (Mounted on an Infinite Heatsink at  $T_A = 125^\circ\text{C}$ )**



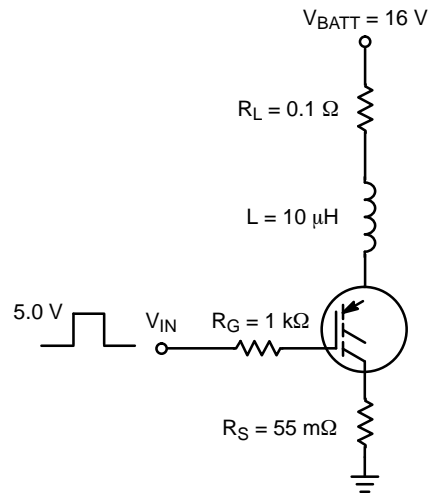
**Figure 15. Pulse Train Safe Operating Area (Mounted on an Infinite Heatsink at  $T_C = 25^\circ\text{C}$ )**



**Figure 16. Pulse Train Safe Operating Area (Mounted on an Infinite Heatsink at  $T_C = 125^\circ\text{C}$ )**



**Figure 17. Circuit Configuration for Short Circuit Test #1**



**Figure 18. Circuit Configuration for Short Circuit Test #2**

# NGD18N40CLB, NGD18N40ACLB

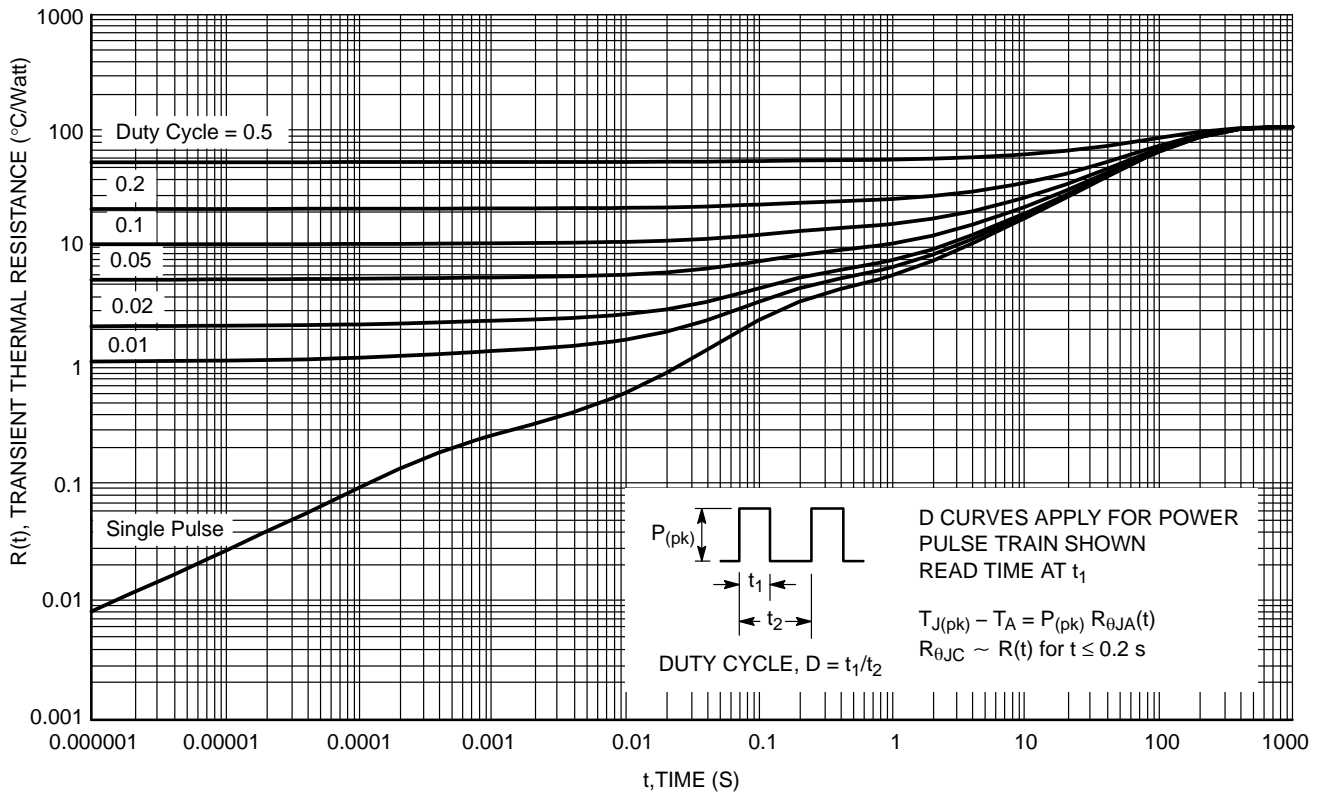
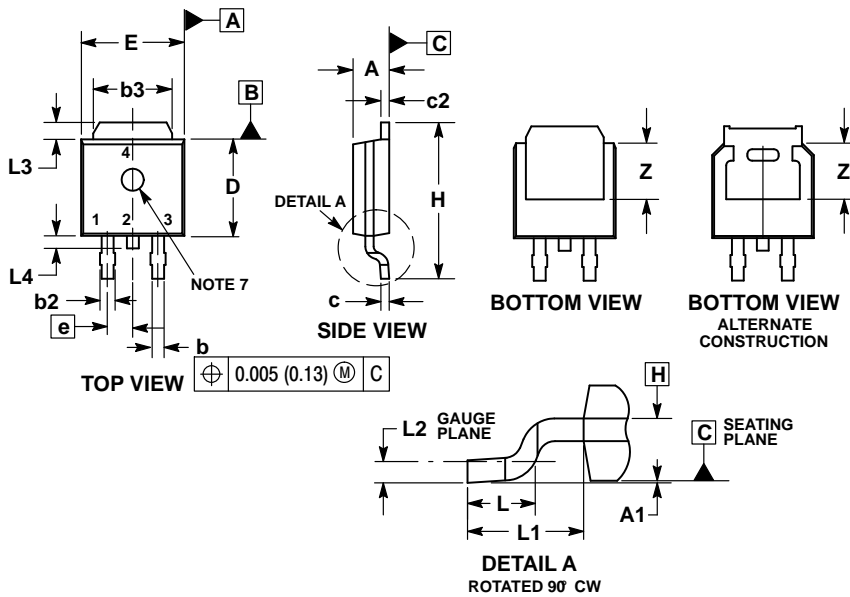


Figure 19. Transient Thermal Resistance (Non-normalized Junction-to-Ambient mounted on minimum pad area)

# NGD18N40CLB, NGD18N40ACLB

## PACKAGE DIMENSIONS

### DPAK CASE 369C ISSUE E



**NOTES:**

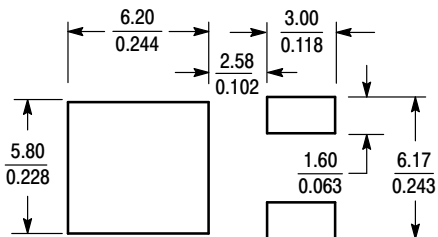
1. DIMENSIONING AND TOLERANCING PER ASME Y14.5M, 1994.
2. CONTROLLING DIMENSION: INCHES.
3. THERMAL PAD CONTOUR OPTIONAL WITHIN DIMENSIONS b3, L3 and Z.
4. DIMENSIONS D AND E DO NOT INCLUDE MOLD FLASH, PROTRUSIONS, OR BURRS. MOLD FLASH, PROTRUSIONS, OR GATE BURRS SHALL NOT EXCEED 0.006 INCHES PER SIDE.
5. DIMENSIONS D AND E ARE DETERMINED AT THE OUTERMOST EXTREMES OF THE PLASTIC BODY.
6. DATUMS A AND B ARE DETERMINED AT DATUM PLANE H.
7. OPTIONAL MOLD FEATURE.

DIM	INCHES		MILLIMETERS	
	MIN	MAX	MIN	MAX
A	0.086	0.094	2.18	2.38
A1	0.000	0.005	0.00	0.13
b	0.025	0.035	0.63	0.89
b2	0.028	0.045	0.72	1.14
b3	0.180	0.215	4.57	5.46
c	0.018	0.024	0.46	0.61
c2	0.018	0.024	0.46	0.61
D	0.235	0.245	5.97	6.22
E	0.250	0.265	6.35	6.73
e	0.090 BSC		2.29 BSC	
H	0.370	0.410	9.40	10.41
L	0.055	0.070	1.40	1.78
L1	0.114 REF		2.90 REF	
L2	0.020 BSC		0.51 BSC	
L3	0.035	0.050	0.89	1.27
L4	0.040		1.01	
Z	0.155	---	3.93	---

**STYLE 7:**

- PIN 1. GATE
- COLLECTOR
- EMITTER
- COLLECTOR

### SOLDERING FOOTPRINT\*



SCALE 3:1  $\left( \frac{\text{mm}}{\text{inches}} \right)$

\*For additional information on our Pb-Free strategy and soldering details, please download the ON Semiconductor Soldering and Mounting Techniques Reference Manual, SOLDERM/D.

ON Semiconductor and are registered trademarks of Semiconductor Components Industries, LLC (SCILLC). SCILLC reserves the right to make changes without further notice to any products herein. SCILLC makes no warranty, representation or guarantee regarding the suitability of its products for any particular purpose, nor does SCILLC assume any liability arising out of the application or use of any product or circuit, and specifically disclaims any and all liability, including without limitation special, consequential or incidental damages. "Typical" parameters which may be provided in SCILLC data sheets and/or specifications can and do vary in different applications and actual performance may vary over time. All operating parameters, including "Typicals" must be validated for each customer application by customer's technical experts. SCILLC does not convey any license under its patent rights nor the rights of others. SCILLC products are not designed, intended, or authorized for use as components in systems intended for surgical implant into the body, or other applications intended to support or sustain life, or for any other application in which the failure of the SCILLC product could create a situation where personal injury or death may occur. Should Buyer purchase or use SCILLC products for any such unintended or unauthorized application, Buyer shall indemnify and hold SCILLC and its officers, employees, subsidiaries, affiliates, and distributors harmless against all claims, costs, damages, and expenses, and reasonable attorney fees arising out of, directly or indirectly, any claim of personal injury or death associated with such unintended or unauthorized use, even if such claim alleges that SCILLC was negligent regarding the design or manufacture of the part. SCILLC is an Equal Opportunity/Affirmative Action Employer. This literature is subject to all applicable copyright laws and is not for resale in any manner.

### PUBLICATION ORDERING INFORMATION

**LITERATURE FULFILLMENT:**  
Literature Distribution Center for ON Semiconductor  
P.O. Box 5163, Denver, Colorado 80217 USA  
**Phone:** 303-675-2175 or 800-344-3860 Toll Free USA/Canada  
**Fax:** 303-675-2176 or 800-344-3867 Toll Free USA/Canada  
**Email:** orderlit@onsemi.com

**N. American Technical Support:** 800-282-9855 Toll Free USA/Canada  
**Europe, Middle East and Africa Technical Support:**  
Phone: 421 33 790 2910  
**Japan Customer Focus Center**  
Phone: 81-3-5817-1050

**ON Semiconductor Website:** [www.onsemi.com](http://www.onsemi.com)

**Order Literature:** <http://www.onsemi.com/orderlit>

For additional information, please contact your local Sales Representative