

FEATURES

- LOW INSERTION LOSS
- HIGH ATTENUATION
- INTERNAL SHIELDING
- SMALL SIZE & LOW PROFILE LTCC CONSTRUCTION
- TAPED AND REELED FOR AUTOMATIC INSERTION

**RoHS
Compliant**

includes all homogeneous materials

*See Part Number System for Details

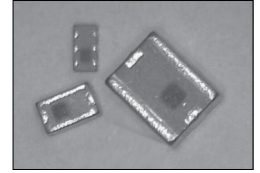

CHARACTERISTICS

Case Code	0402	0603	0805	1206
Center Frequency Ranges	1710 MHz ~ 2450 MHz	870 MHz ~ 2450 MHz	902.5 MHz ~ 5787.5 MHz	560 MHz ~ 2441.5 MHz
Operating Temperature Range	-40°C ~ +85°C			
Bandwidth	±12.5MHz ~ ±200MHz (Refer to Individual Part Numbers for Specific Values)			
Resistance to Solder Heat	+260°C for 10 seconds			

DIMENSIONS (mm)

Case Code	DIMENSIONS (mm)			
	A	B	C	Pin Layout and Dimensions
NGFL0402	1.0 ± 0.05	0.5 ± 0.05	0.38 ± 0.05	Refer to Individual Part Number Table
NGFL0603	1.6 ± 0.10	0.8 ± 0.10	0.6 ± 0.10	
NGFL0805	2.0 ± 0.15	1.2 ± 0.15	0.95 ± 0.10	
NGFL1206	3.2 ± 0.15	1.6 ± 0.15	0.95 ± 0.10	

PART NUMBER SYSTEM

NGFL 0805AB 2R450G 050 TR F

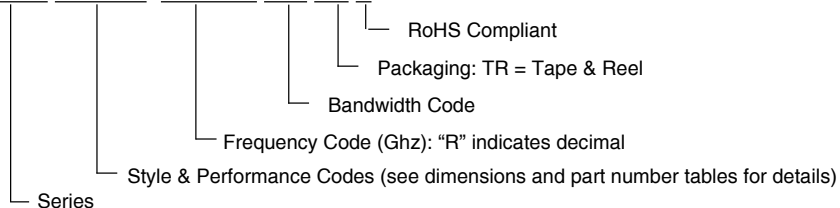

NGFL0402 Size

Part Number	Standard Values - Case Size 0402 (1.0 x 0.5 x 0.38mm)				
	Center Frequency (MHz)	Bandwidth (MHz)	Max. IL in BW @ 25°C (dB)	Attenuation (dB)	Component Thickness
NGFL0402AG1R710G100TRF	1710	$f_0 \pm 100$	0.4dB Min. at 820~920MHz	10.0dB Min. at 3420~3820MHz	0.38 ± 0.05
			0.9dB Min. at 1710~2050MHz		
NGFL0402BG2R450G050TRF	2450	$f_0 \pm 50$	0.45	21.0dB Min. at $2 \times (f_0 \pm 50)$ MHz	
				21.0dB Min. at $3 \times (f_0 \pm 50)$ MHz	

(Customization Available. Please contact NIC for any center frequency and response customizations)

COMPONENT LAYOUT (in mm)

Style "A"

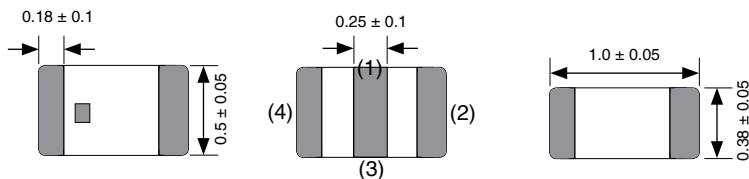

Style "B"

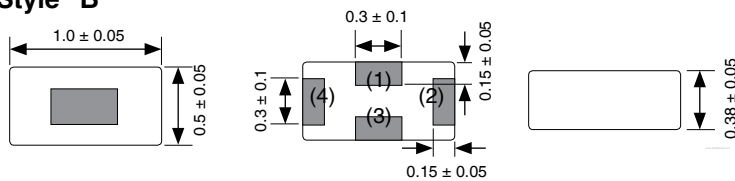

NGFL0402 Style Code	(1)	(2)	(3)	(4)
Style "A"	Ground	Out	Ground	In
Style "B"	Ground	Out/In	Ground	In/Out

LAND PATTERNS (in mm)

Style "A"

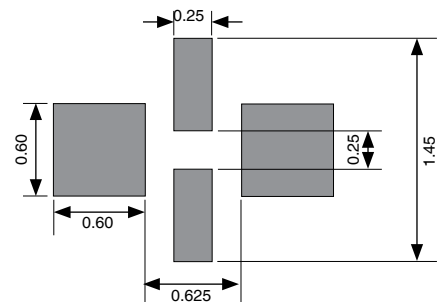

Style "B"

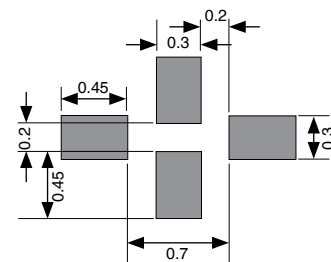

NGFL0603 Size

Part Number	Standard Values - Case Size 0603 (1.6 x 0.8 x 0.6mm)				Component Thickness
	Center Frequency (MHz)	Bandwidth (MHz)	Max. IL in BW 25°C (dB)	Attenuation (dB)	
NGFL0603AG2R450G050TRF	2450	$f_0 \pm 50.0$	0.6	35.0dB min. at 4800 ~ 5000MHz	0.60 ± 0.10
				30.0dB min. at 7200 ~ 7500MHz	
NGFL0603BG2R450G200TRF	2450	$f_0 \pm 200.0$	0.4	27.0dB min. at 4600 ~ 5400MHz	
				25.0dB min. at 6900 ~ 8100MHz	

[Customization Available. Please contact NIC for any center frequency and response customizations]

COMPONENT LAYOUT (in mm)

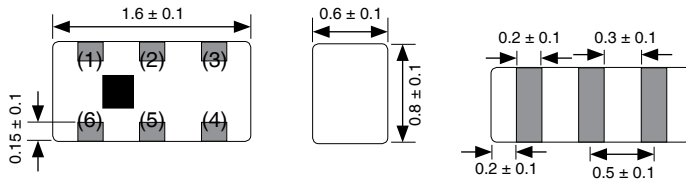

LAND PATTERNS (in mm)

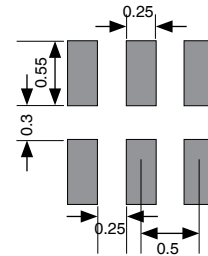

NGFL0603 Style Code	(1)	(2)	(3)	(4)	(5)	(6)
Style A	Ground	In	Ground	Ground	Out	Ground
Style B	In	Ground	Out	NC	Ground	NC

NGFL0805 Size

Part Number	Standard Values - Case Size 0805 (2.0 x 1.2mm)				
	Center Frequency (MHz)	Bandwidth (MHz)	Max. IL in BW @ 25°C (dB)	Attenuation (dB)	Component Thickness
NGFL0805AG0R902G012TRF	902.5	$f_0 \pm 12.5$	0.6	30.0dB Min. at $2 \times (f_0 \pm 50)$ MHz	0.95 ± 0.10
				30.0dB Min. at $3 \times (f_0 \pm 50)$ MHz	
NGFL0805AG2R450G050TRF	2450	$f_0 \pm 50.0$	0.5	27.0dB Min. at $2 \times (f_0 \pm 50)$ MHz	
				30.0dB Min. at $3 \times (f_0 \pm 50)$ MHz	
				30.0dB Min. at $4 \times (f_0 \pm 50)$ MHz	
NGFL0805BG2R450G050TRF	2450	$f_0 \pm 50.0$	0.5	27.0dB min. at $2 \times f_0$ MHz	
				25.0dB min. at $3 \times f_0$ MHz	
				25.0dB min. at $4 \times f_0$ MHz	

(Customization Available. Please contact NIC for any center frequency and response customizations)

COMPONENT LAYOUT (in mm)

Style "A"

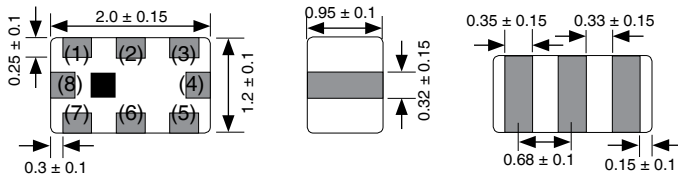

Style "B"

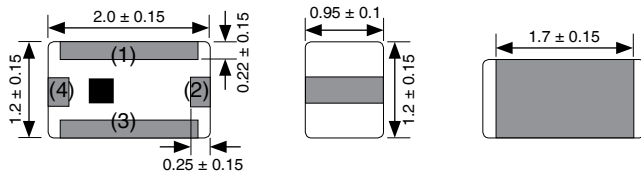

LAND PATTERNS (in mm)

Style "A"

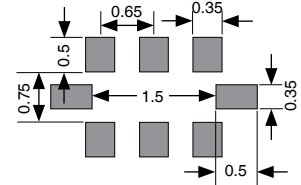

Style "B"

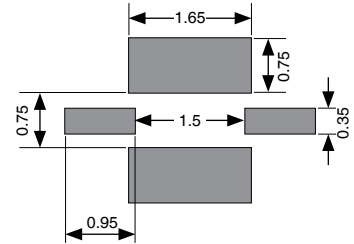

NGFL0805 Style Code	(1)	(2)	(3)	(4)	(5)	(6)	(7)	(8)
Style "A"	Ground	NC	Ground	Out	Ground	NC	Ground	In
Style "B"	Ground	Out	Ground	In	-	-	-	-

NGFL1206 Size

Part Number	Standard Values - Case Size 1206 (3.2 x 1.6 x 0.95mm)			
	Center Frequency (MHz)	Bandwidth (MHz)	Max. IL in BW @ 25°C (dB)	Attenuation (dB)
NGFL1206AG0R560G050TRF	560	$f_0 \pm 50.0$	1.0dB Min. at 0~400MHz	20.0dB Min. at 660MHz
			3.0dB Min. at 560MHz	40.0dB Min. at 680~3000MHz 20.0dB Min. at 660~5500MHz
NGFL1206BG2R450G041TRF	2441.5	$f_0 \pm 41.5$	0.6	30.0dB Min. at $2 \times (f_0 \pm 41.5)$ MHz
				18.0dB Min. at $3 \times (f_0 \pm 41.5)$ MHz

[Customization Available. Please contact NIC for any center frequency and response customizations]

COMPONENT LAYOUT (in mm)

All Styles

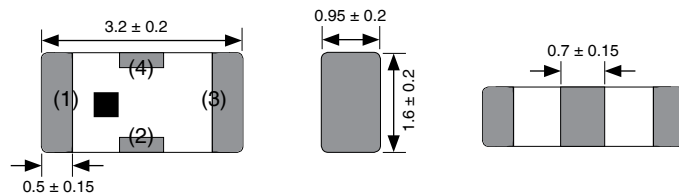

NGFL1206 Style Code	(1)	(2)	(3)	(4)
All Styles	In	Ground	Out	Ground

LAND PATTERNS (in mm)

Style "A"

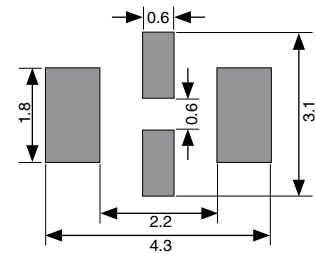

Style "B"

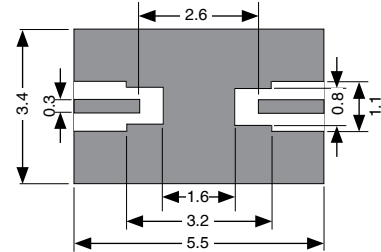

Case Size	CARRIER TAPING DIMENSIONS (mm) AND REEL QUANTITY									
	Tape	Ao	Bo	Po	So	Co	Ko	t	W	Qty
NGFL0402	Paper	0.62	1.12	2.0	2.0 ±0.05	3.5 ± 0.1	0.45 max.	-	8.0 ± 0.3	10,000
NGFL0603		1.00	1.80	4.0			0.75 max.	-		4,000
NGFL0805	Embossed	1.42	2.25	4.0			1.14 max.	0.27 max.		4,000
NGFL1206		1.85	3.50	4.0			1.14 max.	0.27 max.		3,000

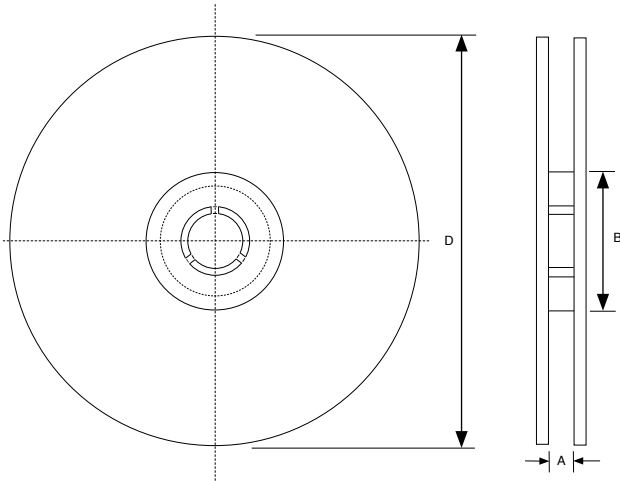
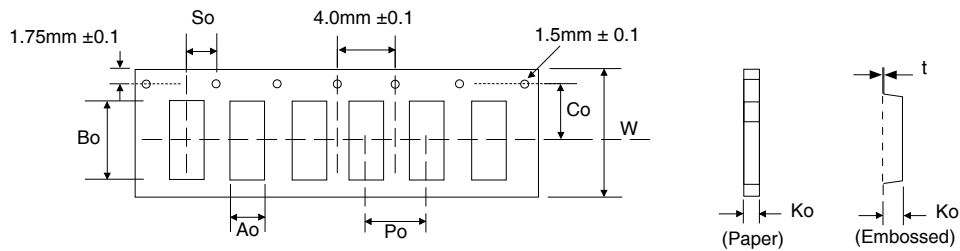

Tape Width	REEL DIMENSIONS (mm)		
	A(mm)	B(mm)	D(mm)
NGFL0402	9.0 ± 1.5	58 ± 2.0	178 ± 2.0
NGFL0603			
NGFL0805			
NGFL1206			

REFLOW SOLDERING PROFILE

