



NGTB10N60FG

N-Channel IGBT 600V, 10A, V_{CE(sat)};1.5V, TO-220F-3FS

ON Semiconductor®

<http://onsemi.com>

Features

- IGBT V_{CE(sat)}=1.5V typ. (I_C=10A, V_{GE}=15V)
- IGBT I_C=20A (T_c=25°C)
- Adaption of full isolation type package
- 5μs short circuit capability
- Diode V_F=1.3V typ.(I_F=10A)
- Diode t_{rr}=70ns typ.
- Enhancement type

Applications

- Power factor correction of white goods appliance
- General purpose inverter

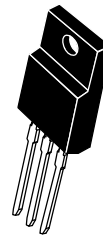

TO-220F-3FS

Specifications

Absolute Maximum Ratings at T_a = 25°C, Unless otherwise specified

Parameter	Symbol	Conditions	Value	Unit	
Collector to Emitter Voltage	V _{CES}		600	V	
Gate to Emitter Voltage	V _{GES}		±20	V	
Collector Current (DC)	I _C ^{*1}	Limited by T _{jmax}	@ T _c =25°C ^{*2}	20	A
			@ T _c =100°C ^{*2}	10	A
Collector Current (Pulse)	I _{CP}	Pulse width Limited by T _{jmax}	72	A	
Diode Average Output Current	I _O		10	A	
Allowable Power Dissipation	P _D	T _c =25°C (Our ideal heat dissipation condition) ^{*2}	40	W	
Junction Temperature	T _j		150	°C	
Storage Temperature	T _{stg}		- 55 to +150	°C	

Note : *1 Collector Current is calculated from the following formula.

$$I_C(T_c) = \frac{T_{jmax} - T_c}{R_{th(j-c)}} \times V_{CE(sat)}(I_C(T_c))$$

*2 Our condition is radiation from backside.

The method is applying silicone grease to the backside of the device and attaching the device to water-cooled radiator made of aluminium.

Stresses exceeding those listed in the Maximum Ratings table may damage the device. If any of these limits are exceeded, device functionality should not be assumed, damage may occur and reliability may be affected.

Electrical Characteristics

 at T_a = 25°C, Unless otherwise specified

Parameter	Symbol	Conditions	Value			Unit
			min	typ	max	
Collector to Emitter Breakdown Voltage	V _{(BR)CES}	I _C =500μA, V _{GE} =0V	600			V
Collector to Emitter Cut off Current	I _{CES}	V _{CE} =600V, V _{GE} =0V	T _c =25°C		10	μA
			T _c =125°C		1	mA
Gate to Emitter Leakage Current	I _{GES}	V _{GE} =±20V, V _{CE} =0V			±100	nA
Gate to Emitter Threshold Voltage	V _{GE(off)}	V _{CE} =20V, I _C =250μA	4.5		6.5	V
Collector to Emitter Saturation Voltage	V _{CE(sat)}	V _{GE} =15V, I _C =10A	T _c =25°C	1.5	1.7	V
			T _c =125°C	1.7		V
Diode Forward Voltage	V _F	I _F =10A		1.3		V
Input Capacitance	C _{ies}	V _{CE} =20V, f=1MHz		1440		pF
Output Capacitance	C _{oes}			60		pF
Reverse Transfer Capacitance	C _{res}			30		pF

ORDERING INFORMATION

See detailed ordering and shipping information on page 6 of this data sheet.

Continued on next page.

NGTB10N60FG

Continued from preceding page.

Parameter	Symbol	Conditions	Value			Unit
			min	typ	max	
Turn-ON Delay Time	$t_{d(on)}$			40		ns
Rise Time	t_r	$V_{CC}=300V, I_C=10A$		23		ns
Turn-ON Time	t_{on}	$R_G=30\Omega, L=200\mu H$		110		ns
Turn-OFF Delay Time	$t_{d(off)}$	$V_{GE}=0V/15V$		145		ns
Fall Time	t_f	$V_{clamp}=400V$		90		ns
Turn-OFF Time	t_{off}	See Fig.1, See Fig.2		240		ns
Total Gate Charge	Q_g			55		nC
Gate to Emitter Charge	Q_{ge}	$V_{CE}=300V, V_{GE}=15V, I_C=10A$		20		nC
Gate to Collector "Miller" Charge	Q_{gc}			10		nC
Diode Reverse Recovery Time	t_{rr}	$I_F=10A, di/dt=100A/\mu s, V_{CC}=50V$, See Fig.3		70		ns

Product parametric performance is indicated in the Electrical Characteristics for the listed test conditions, unless otherwise noted. Product performance may not be indicated by the Electrical Characteristics if operated under different conditions.

Thermal Characteristics at $T_a = 25^\circ C$, Unless otherwise specified

Parameter	Symbol	Conditions	Value	Unit
Thermal Resistance IGBT (junction- Case)	$R_{th(j-c)}$ (IGBT)	$T_c=25^\circ C$ (Our ideal heat dissipation condition)*2	3.09	$^\circ C/W$
Thermal Resistance Diode (junction- Case)	$R_{th(j-c)}$ (Diode)	$T_c=25^\circ C$ (Our ideal heat dissipation condition)*2	4	$^\circ C/W$
Thermal Resistance (junction- ambient)	$R_{th(j-a)}$		59.5	$^\circ C/W$

Fig.1 Switching Time Test Circuit

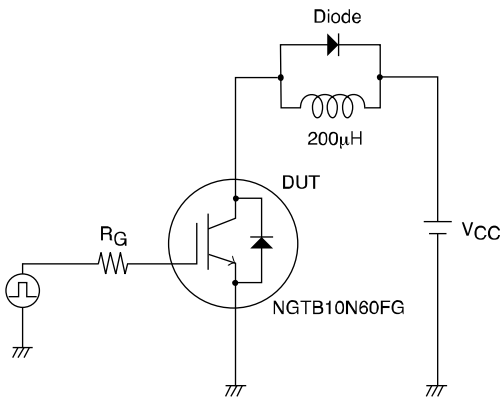
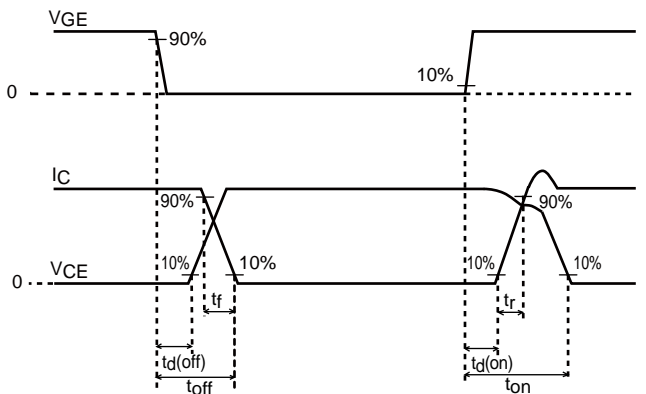
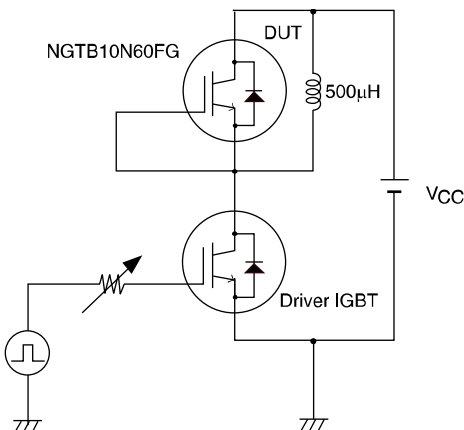

Fig.2 Timing Chart



IT16383

Fig.3 Reverse Recovery Time Test Circuit



NGTB10N60FG

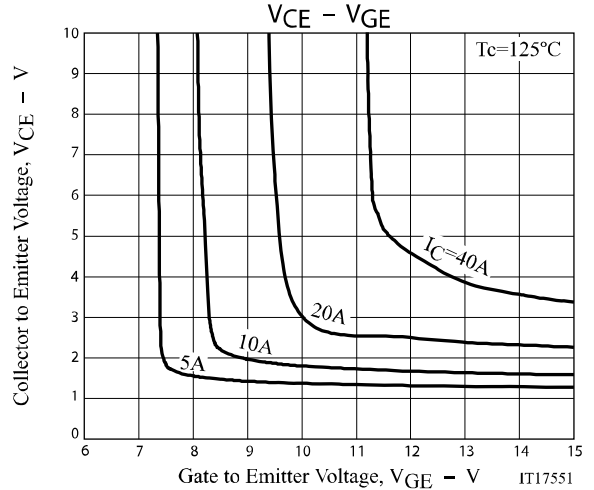
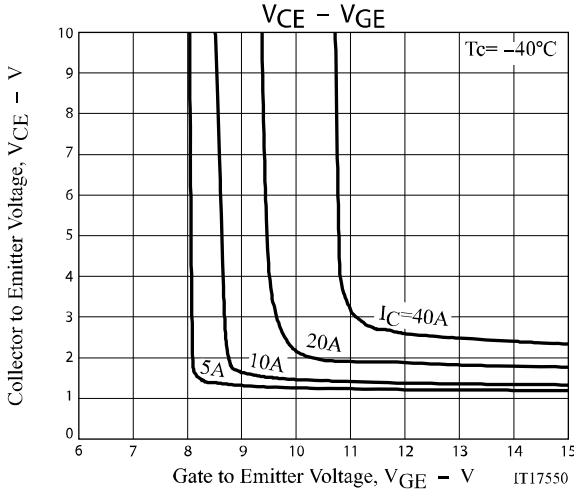
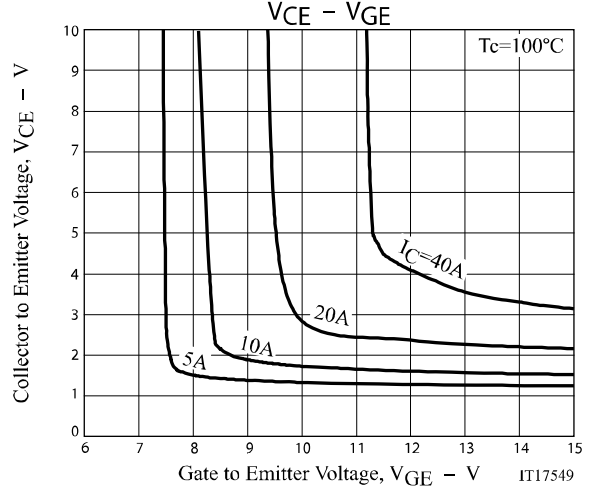
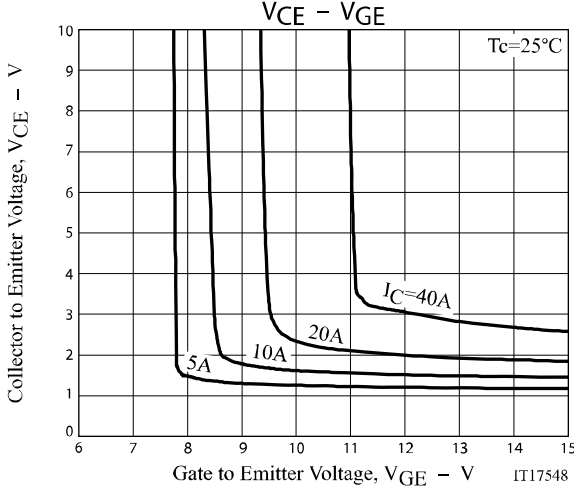
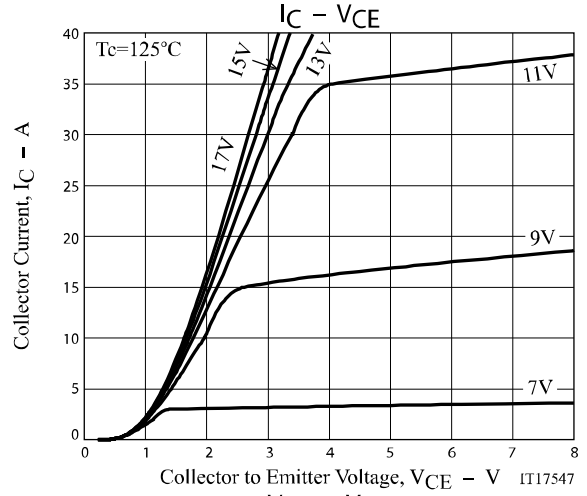
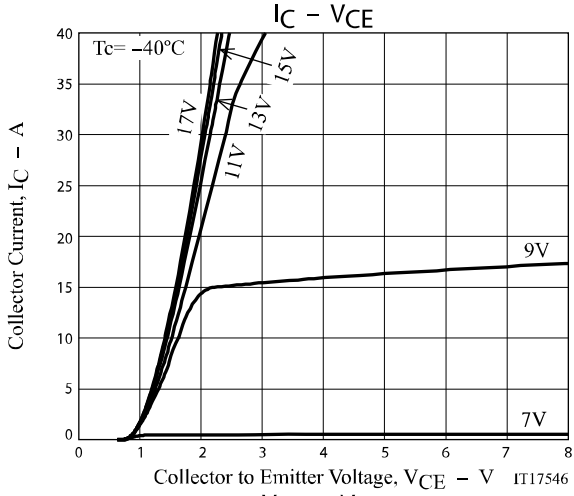
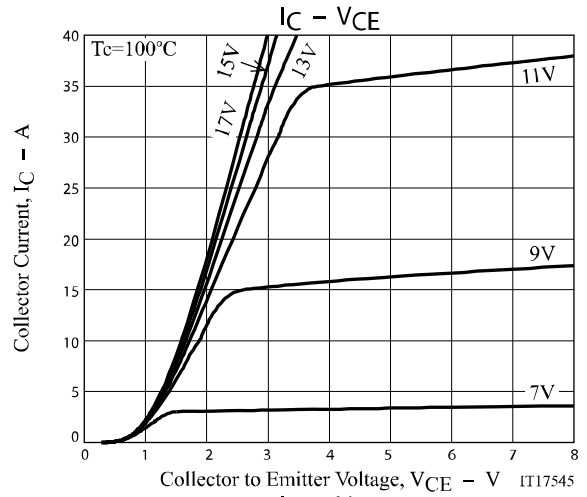
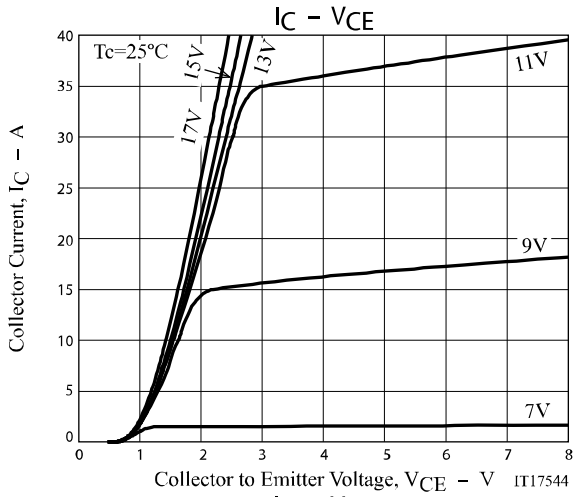

NGTB10N60FG

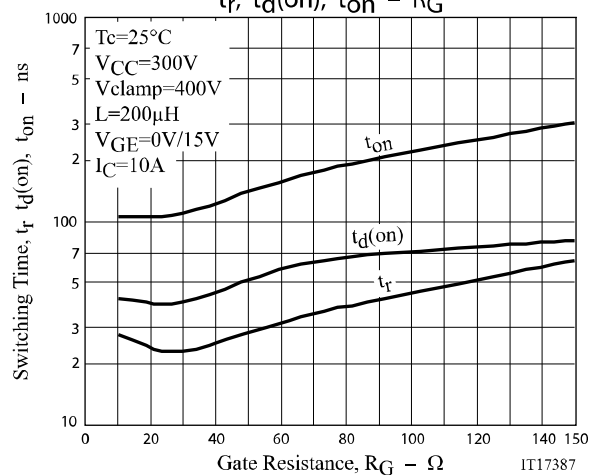
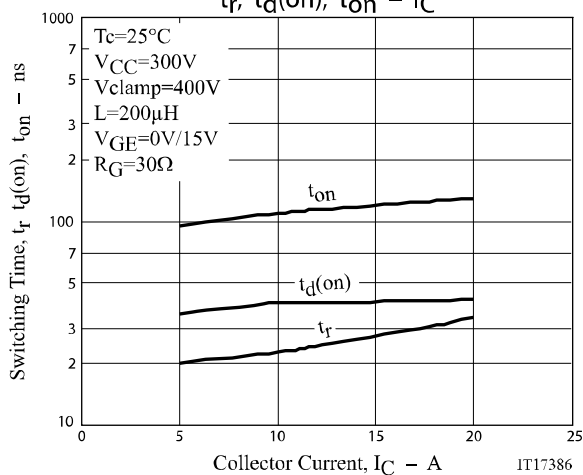
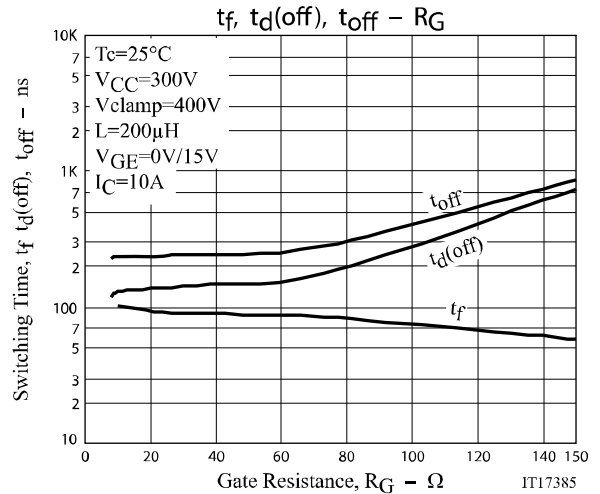
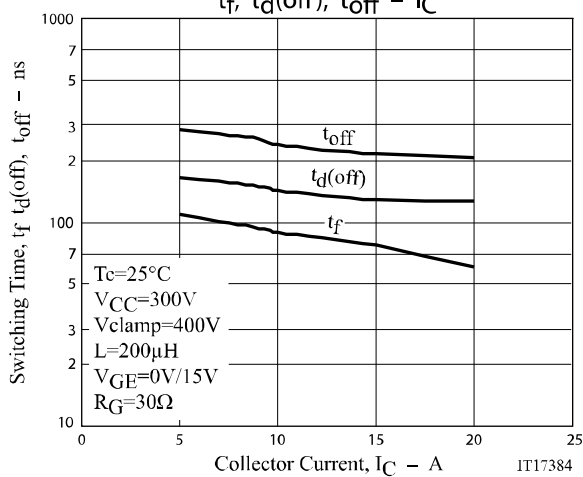
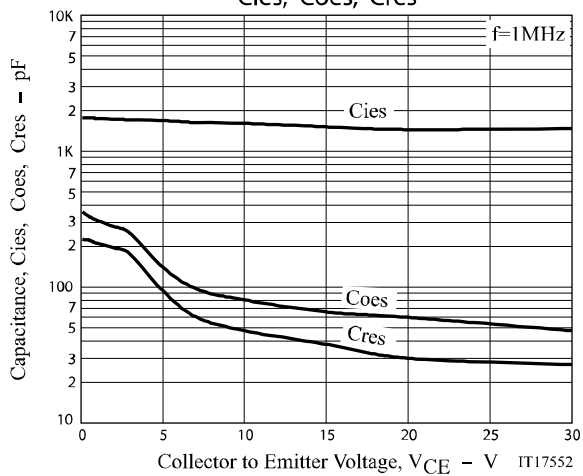
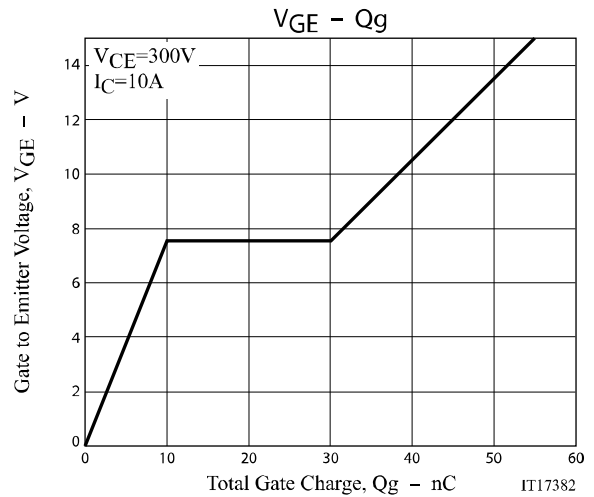
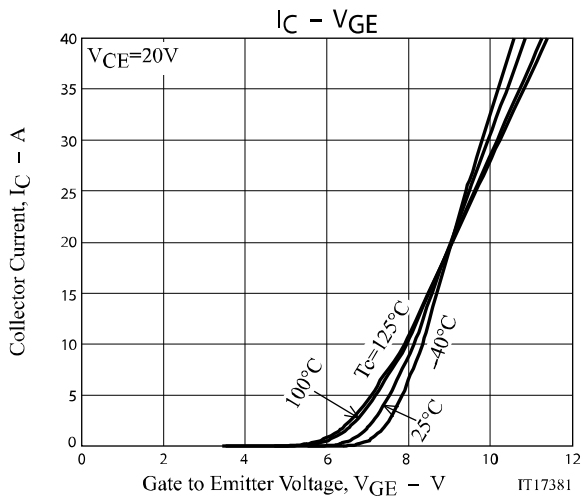

NGTB10N60FG

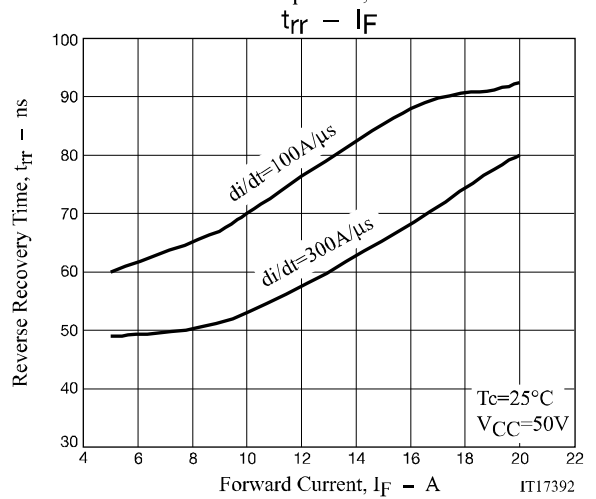
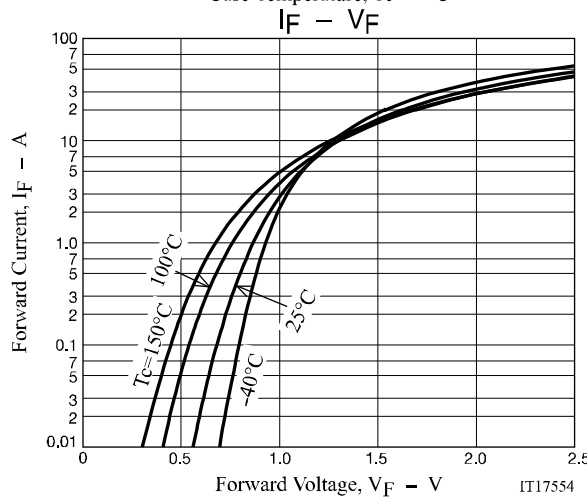
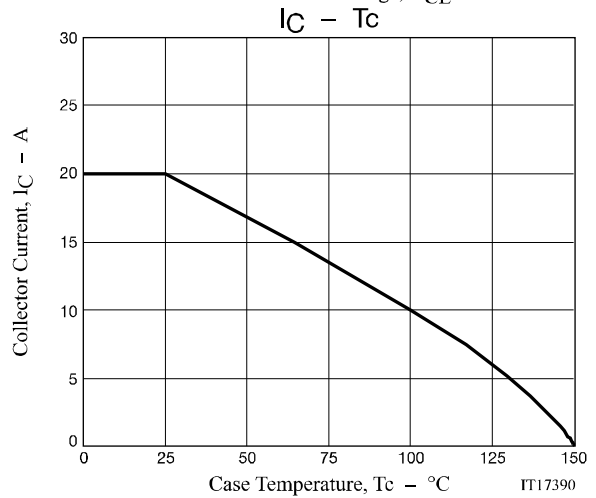
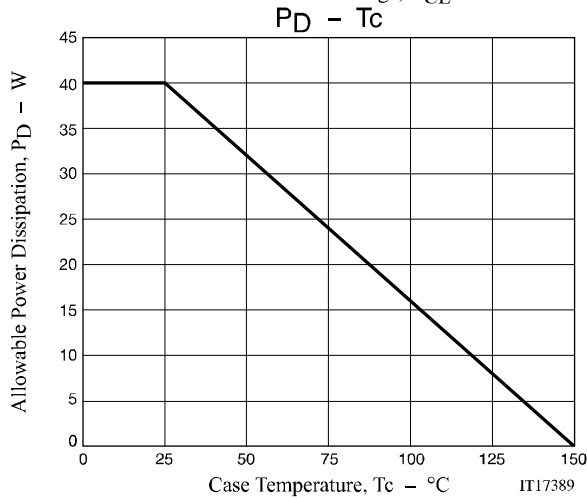
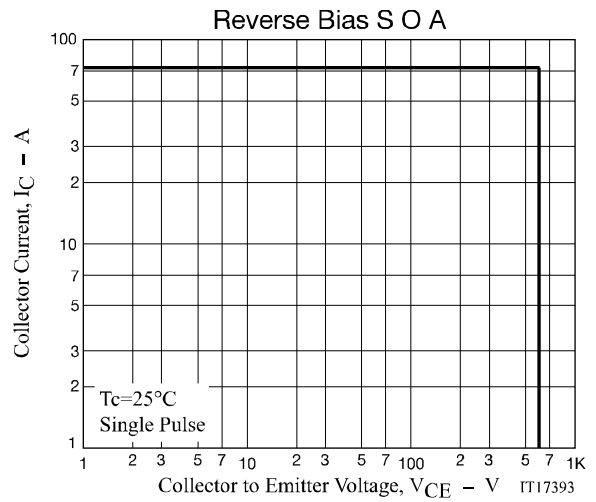
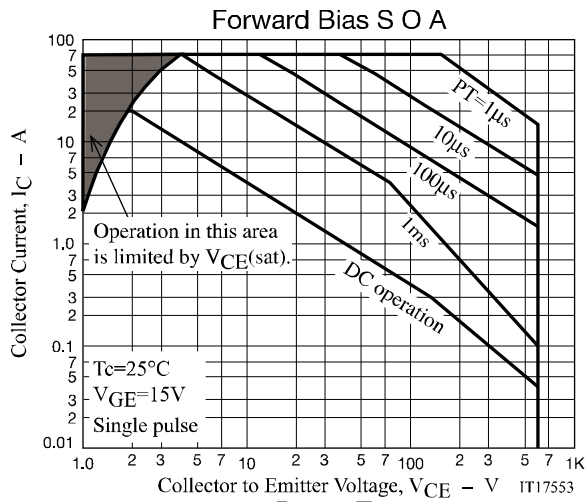

NGTB10N60FG

Package Dimensions

NGTB10N60FG

TO-220F-3FS

CASE 221AM

ISSUE O

Unit : mm

1: Gate

2: Collector

3: Emitter

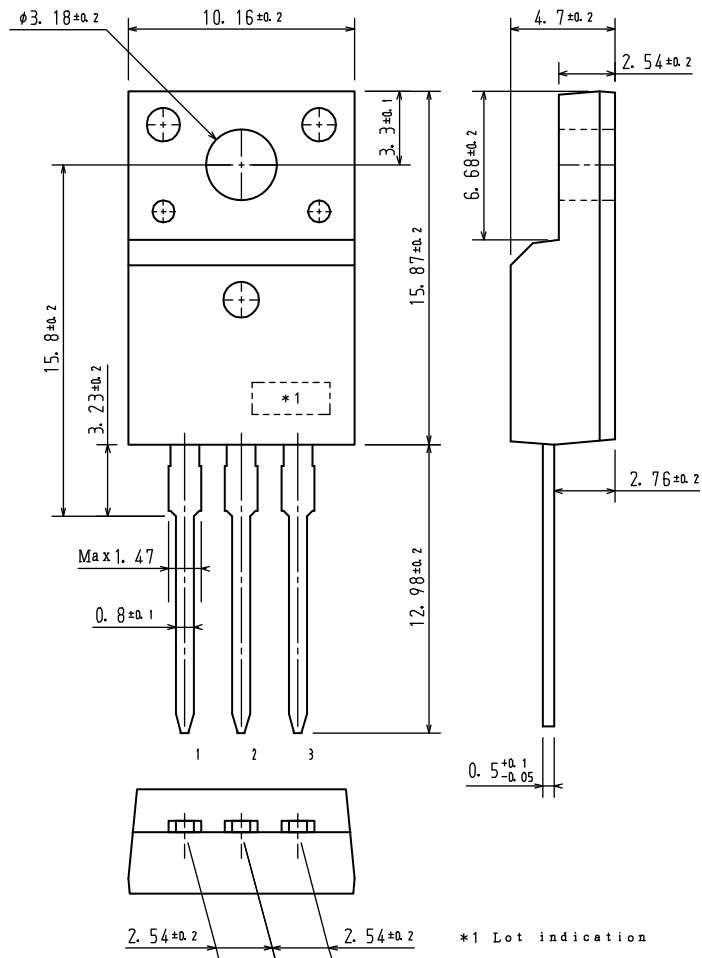

Ordering & Package Information

Device	Package	Shipping	note
NGTB10N60FG	TO-220F-3FS SC-67	50 pcs. / tube	Pb-Free

Marking

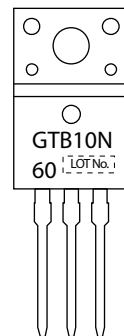

Electrical Connection

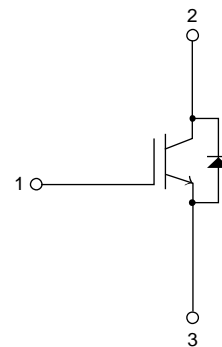

ON Semiconductor and the ON logo are registered trademarks of Semiconductor Components Industries, LLC (SCILLC). SCILLC owns the rights to a number of patents, trademarks, copyrights, trade secrets, and other intellectual property. A listing of SCILLC's product/patent coverage may be accessed at www.onsemi.com/site/pdf/Patent-Marking.pdf. SCILLC reserves the right to make changes without further notice to any products herein. SCILLC makes no warranty, representation or guarantee regarding the suitability of its products for any particular purpose, nor does SCILLC assume any liability arising out of the application or use of any product or circuit, and specifically disclaims any and all liability, including without limitation special, consequential or incidental damages. "Typical" parameters which may be provided in SCILLC data sheets and/or specifications can and do vary in different applications and actual performance may vary over time. All operating parameters, including "Typicals" must be validated for each customer application by customer's technical experts. SCILLC does not convey any license under its patent rights nor the rights of others. SCILLC products are not designed, intended, or authorized for use as components in systems intended for surgical implant into the body, or other applications intended to support or sustain life, or for any other application in which the failure of the SCILLC product could create a situation where personal injury or death may occur. Should Buyer purchase or use SCILLC products for any such unintended or unauthorized application, Buyer shall indemnify and hold SCILLC and its officers, employees, subsidiaries, affiliates, and distributors harmless against all claims, costs, damages, and expenses, and reasonable attorney fees arising out of, directly or indirectly, any claim of personal injury or death associated with such unintended or unauthorized use, even if such claim alleges that SCILLC was negligent regarding the design or manufacture of the part. SCILLC is an Equal Opportunity/Affirmative Action Employer. This literature is subject to all applicable copyright laws and is not for resale in any manner.