



ON Semiconductor®

<http://onsemi.com>

NGTB30N60L2WG

N-Channel IGBT With Low VF Switching Diode 600V, 30A, VCE(sat);1.4V

Features

- IGBT VCE(sat)=1.4V typ. (IC=30A, VGE=15V)
- IGBT IC=100A (Tc=25°C)
- IGBT tf=80ns typ.
- Low switching loss in higher frequency applications
- Maximum junction temperature Tj=175°C
- Diode VF=1.7V typ. (IF=30A)
- Diode trr=70ns typ.
- 5μs short circuit capability
- Pb-free, Halogen-free and RoHS Compliance

Applications

- Power factor correction of white goods appliance

Specifications

Absolute Maximum Ratings at Ta = 25°C, Unless otherwise specified

Parameter	Symbol	Value	Unit	
Collector to Emitter Voltage	V _{CES}	600	V	
Gate to Emitter Voltage	V _{GES}	±20	V	
Collector Current (DC)	I _C *1	@Tc=25°C *2	100	A
Limited by Tjmax		@Tc=100°C *2	30	A
Pulsed collector current, tp=100ms limited by Tjmax	I _{Cpulse}	60	A	
Pulsed collector current, tp=1ms limited by Tjmax	I _{Cpeak}	232	A	
Diode Average Output Current	I _O	30	A	
Power Dissipation Tc=25°C (Our ideal heat dissipation condition) *2	P _D	225	W	
Junction Temperature	T _j	175	°C	
Storage Temperature	T _{stg}	-55 to +175	°C	

Note : *1 Collector Current is calculated from the following formula.

$$I_C(T_c) = \frac{T_{jmax} - T_c}{R_{th(j-c)} \times V_{CE(sat)}(I_C(T_c))}$$

*2 Our condition is radiation from backside.

The method is applying silicone grease to the backside of the device and attaching the device to water-cooled radiator made of aluminum.

Stresses exceeding those listed in the Maximum Ratings table may damage the device. If any of these limits are exceeded, device functionality should not be assumed, damage may occur and reliability may be affected.

Electrical Connection

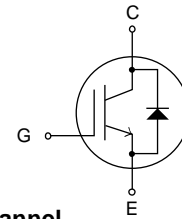

N-channel

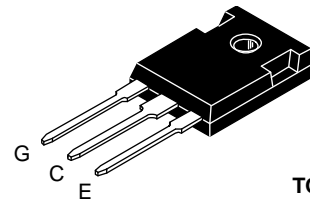
TO-247
CASE 340AK

Marking

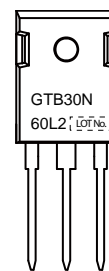

ORDERING INFORMATION

See detailed ordering and shipping information on page 8 of this data sheet.

NGTB30N60L2WG

Electrical Characteristics at Ta = 25°C, Unless otherwise specified

Parameter	Symbol	Conditions	Value			Unit	
			min	typ	max		
Collector to Emitter Breakdown Voltage	V(BR)CES	IC=500μA, VGE=0V	600			V	
Collector to Emitter Cut off Current	ICES	VCE=600V, VGE=0V			10	μA	
					1	mA	
Gate to Emitter Leakage Current	IGES	VGE=±20V, VCE =0V			±100	nA	
Gate to Emitter Threshold Voltage	VGE(th)	VCE =20V, IC=250μA	4.5		6.5	V	
Collector to Emitter Saturation Voltage	VCE(sat)	VGE=15V, IC=30A		1.4	1.6	V	
					1.7	V	
		VGE=15V, IC=50A		1.65		V	
Diode Forward Voltage	VF	IF=30A		1.7		V	
Input Capacitance	Cies	VCE =20V, f=1MHz		4130		pF	
Output Capacitance	Coes			114		pF	
Reverse Transfer Capacitance	Cres			96		pF	
Turn-ON Delay Time	t _{d(on)}			100		ns	
Rise Time	t _r	VCC=300V, IC=30A RG=30Ω, L=200μH VGE=0V/15V Vclamp=400V See Fig.1, See Fig.2		60		ns	
Turn-ON Time	ton			540		ns	
Turn-OFF Delay Time	t _{d(off)}			390		ns	
Fall Time	t _f			80		ns	
Turn-OFF Time	toff			500		ns	
Turn-ON Energy	Eon			0.31		mJ	
Turn-OFF Energy	Eoff			1.14		mJ	
Turn-ON Delay Time	t _{d(on)}		VCC=300V, IC=50A RG=30Ω, L=200μH VGE=0V/15V Vclamp=400V See Fig.1, See Fig.2		98		ns
Rise Time	t _r				85		ns
Turn-ON Time	ton				650		ns
Turn-OFF Delay Time	t _{d(off)}			380		ns	
Fall Time	t _f			90		ns	
Turn-OFF Time	toff			530		ns	
Turn-ON Energy	Eon			0.638		mJ	
Turn-OFF Energy	Eoff			2.755		mJ	
Total Gate Charge	Qg	VCE =300V, VGE=15V, IC=30A		166		nC	
Gate to Emitter Charge	Qge			40		nC	
Gate to Collector "Miller" Charge	Qgc			70		nC	
Diode Reverse Recovery Time	t _{rr}	IF=10A, di/dt=100A/μs, VCC=50V, See Fig.3		70		ns	

Product parametric performance is indicated in the Electrical Characteristics for the listed test conditions, unless otherwise noted. Product performance may not be indicated by the Electrical Characteristics if operated under different conditions.

Thermal Characteristics at Ta = 25°C, Unless otherwise specified

Parameter	Symbol	Conditions	Value	Unit
Thermal Resistance IGBT (Junction to Case)	Rth(j-c) (IGBT)	Tc=25°C (Our ideal heat dissipation condition)*2	0.67	°C /W
Thermal Resistance Diode (Junction to Case)	Rth(j-c) (Diode)	Tc=25°C (Our ideal heat dissipation condition)*2	1.5	°C /W
Thermal Resistance (Junction to Ambient)	Rth(j-a)		41	°C /W

Note : *2 Our condition is radiation from backside.

The method is applying silicone grease to the backside of the device and attaching the device to water-cooled radiator made of aluminum.

NGTB30N60L2WG

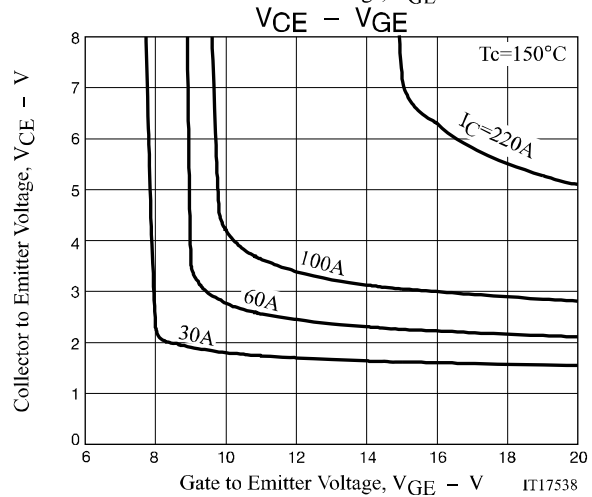
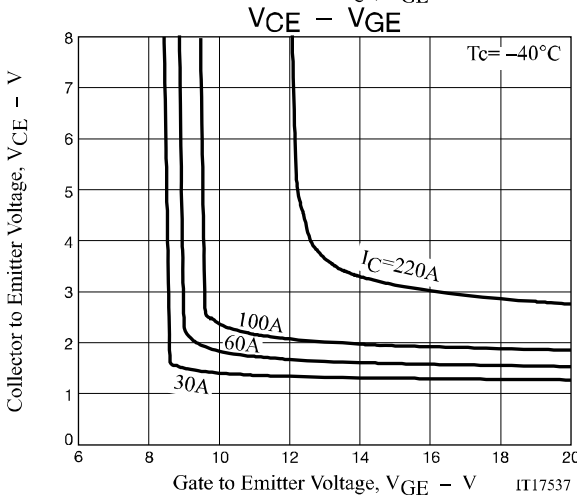
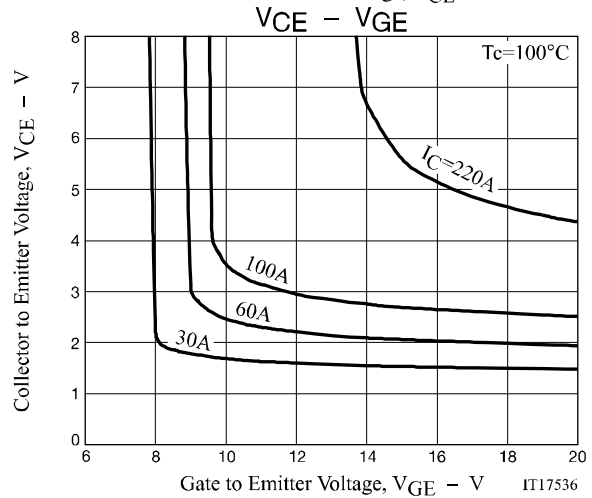
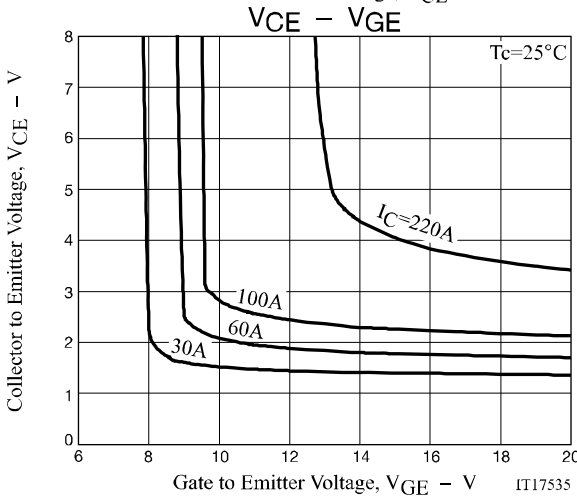
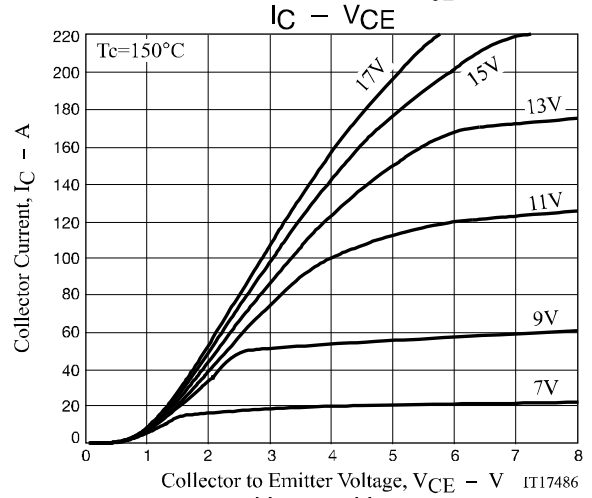
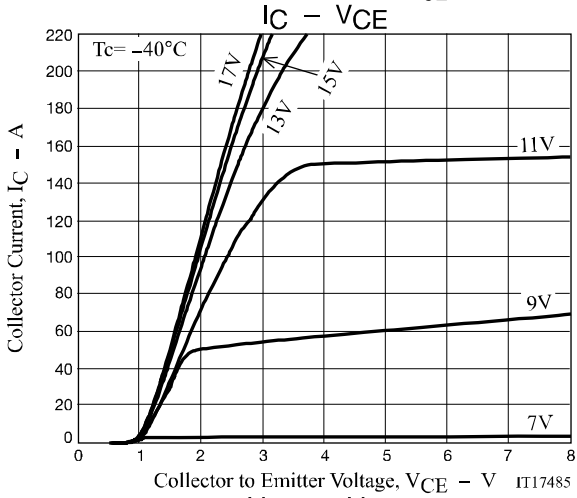
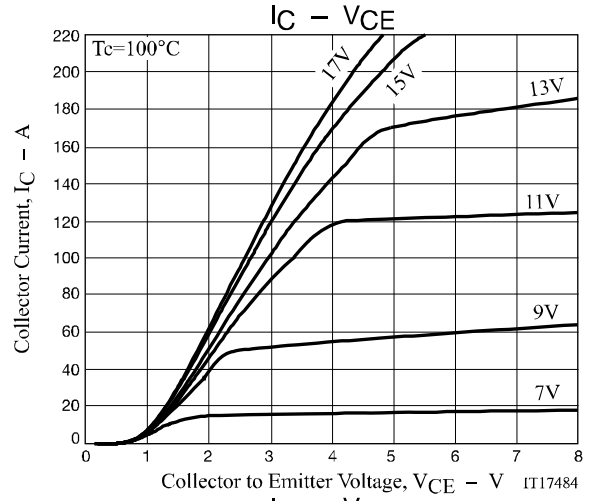
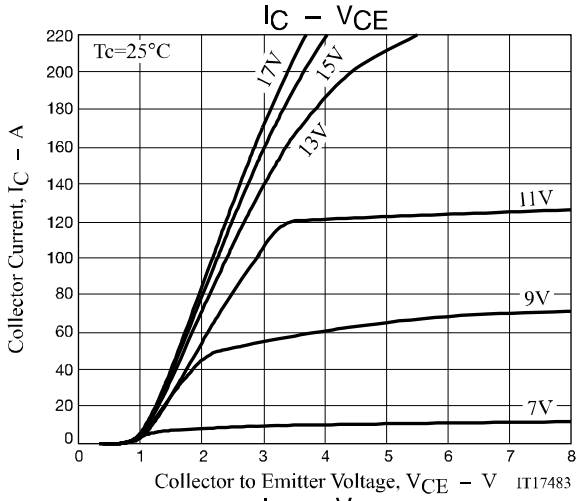

NGTB30N60L2WG

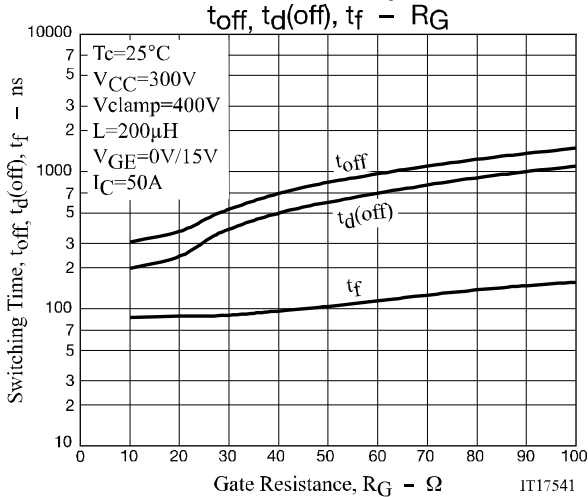
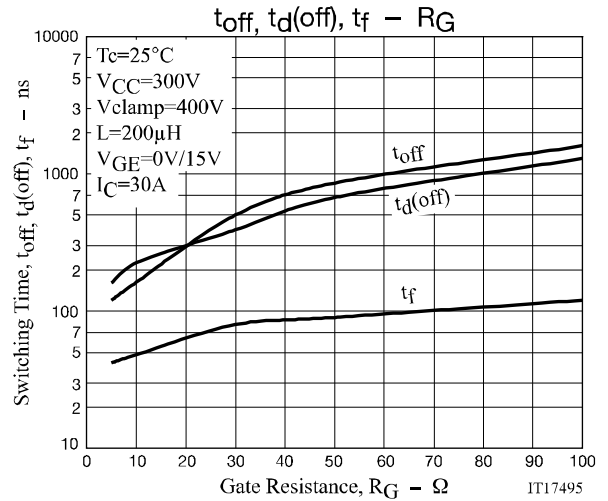
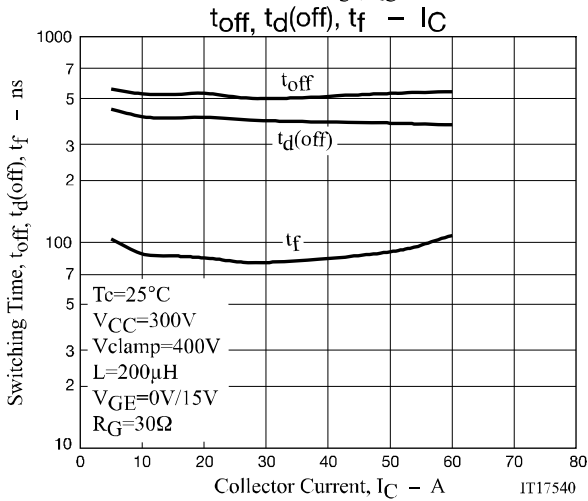
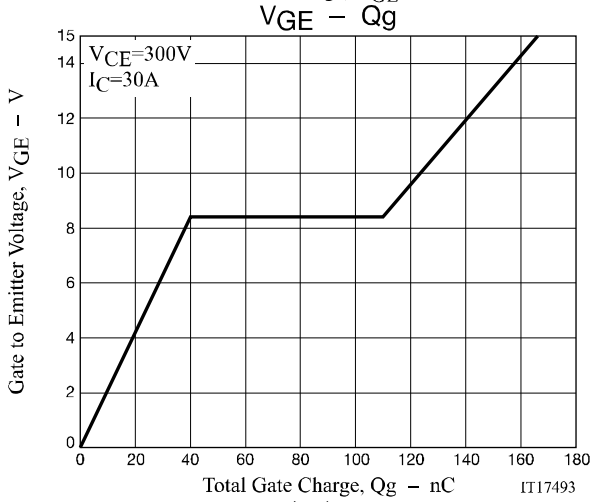
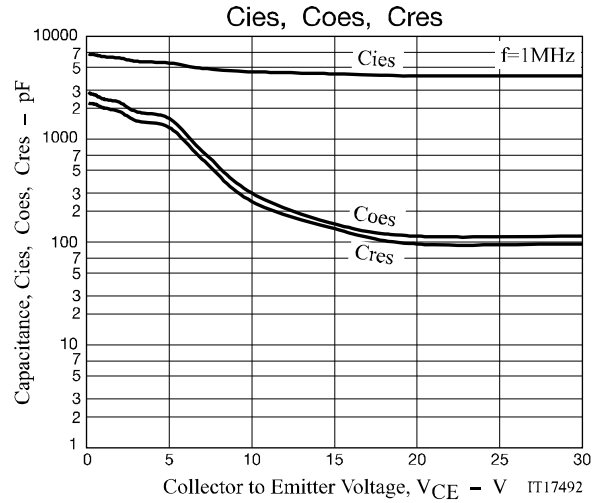
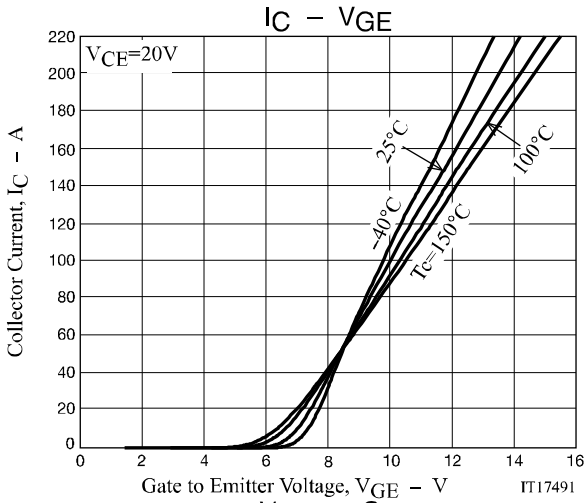

NGTB30N60L2WG

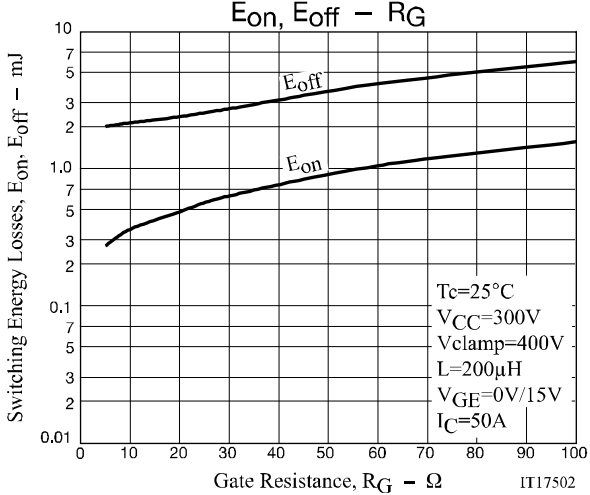
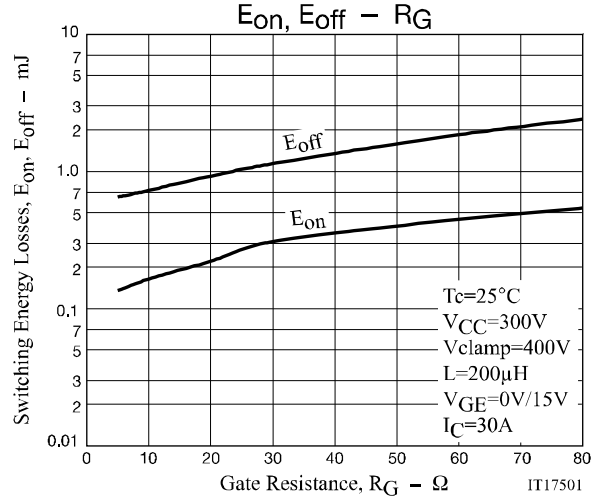
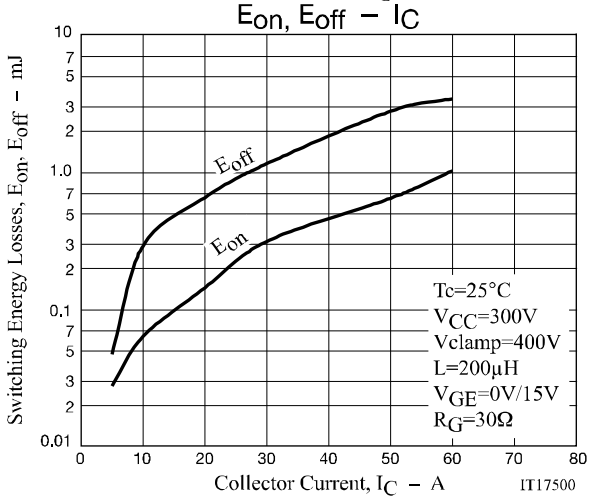
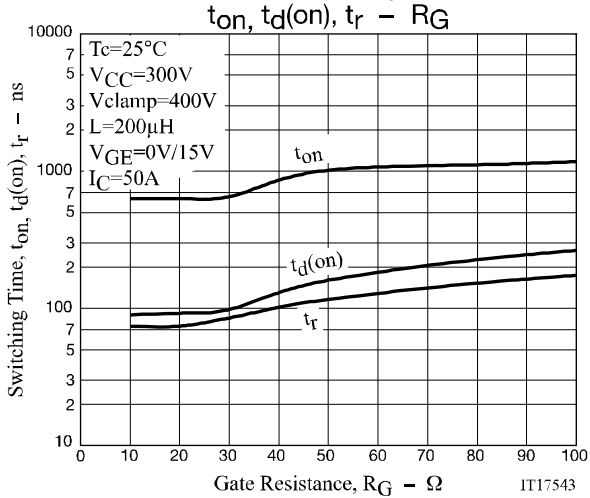
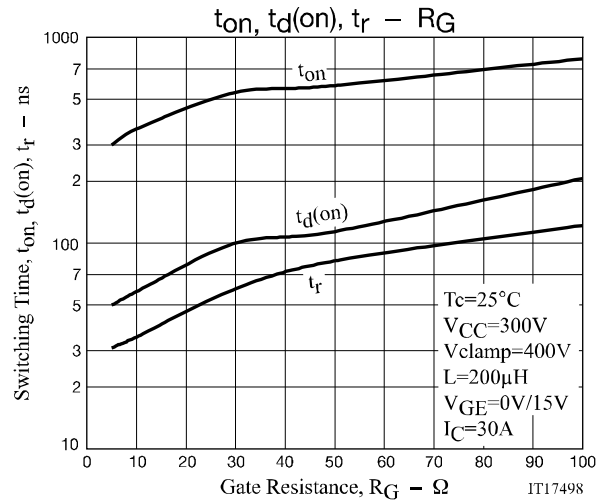
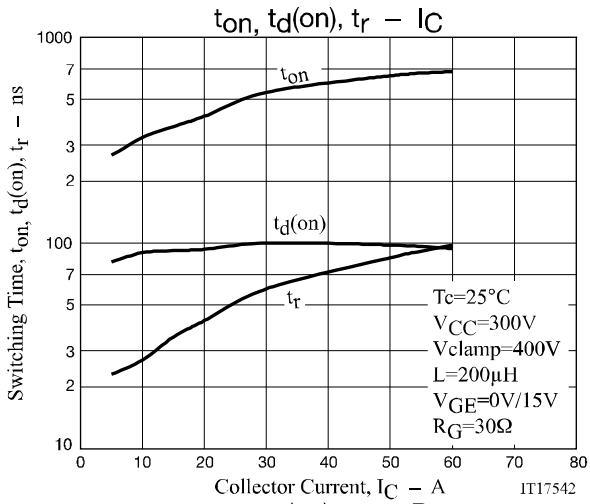

NGTB30N60L2WG

Forward Bias S O A

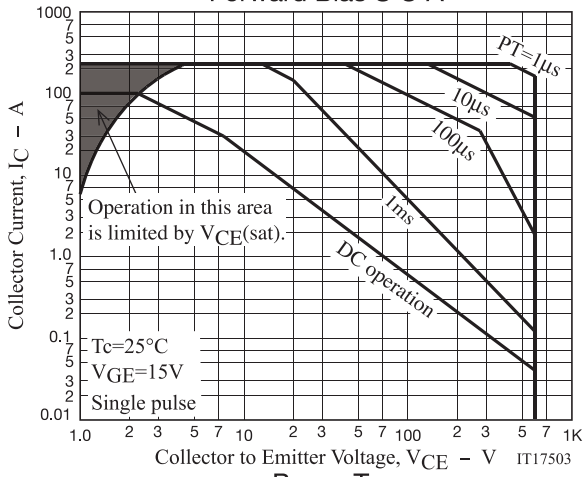

Reverse Bias S O A

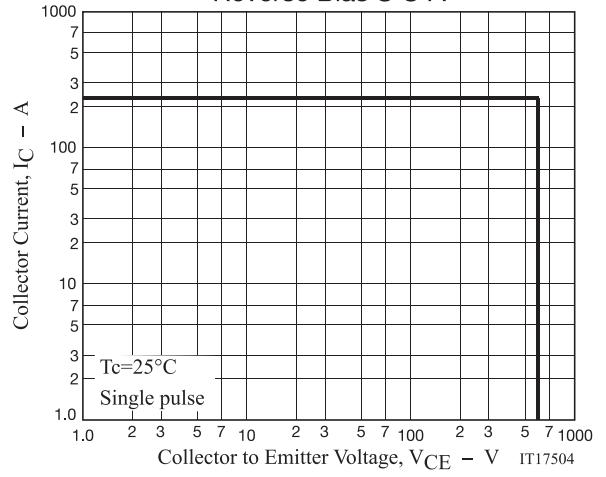

PD - Tc

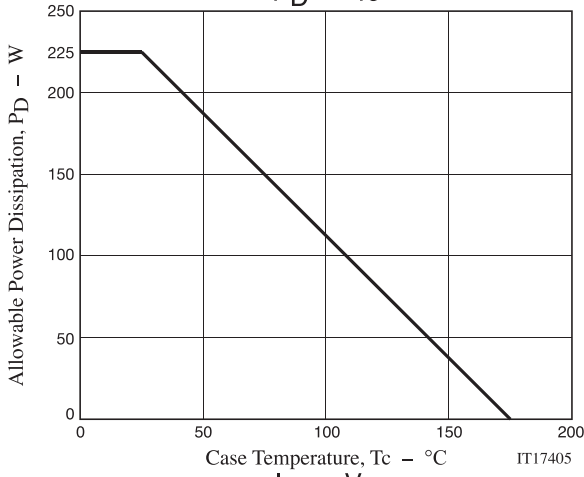

IF - VF

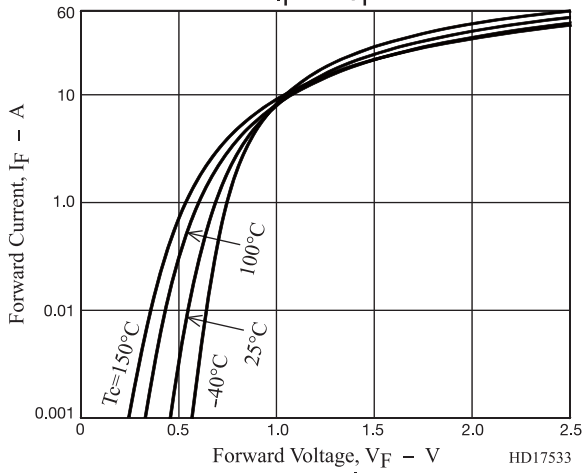

IF - VF

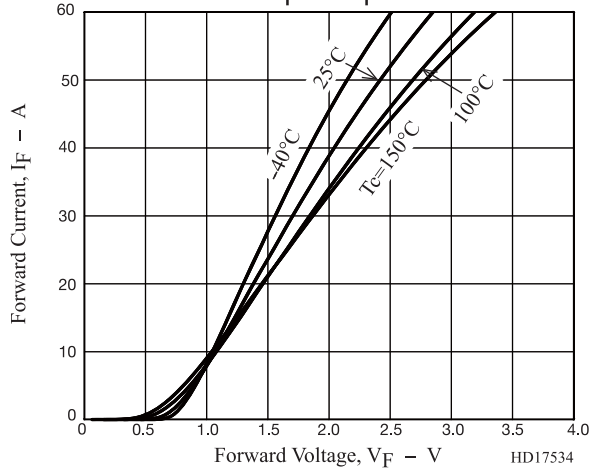

trr - IF

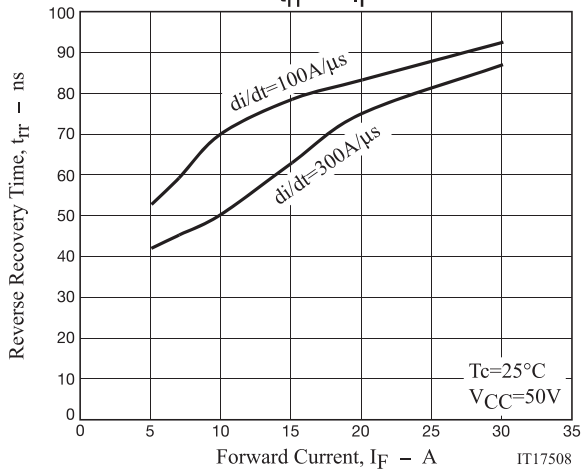

NGTB30N60L2WG

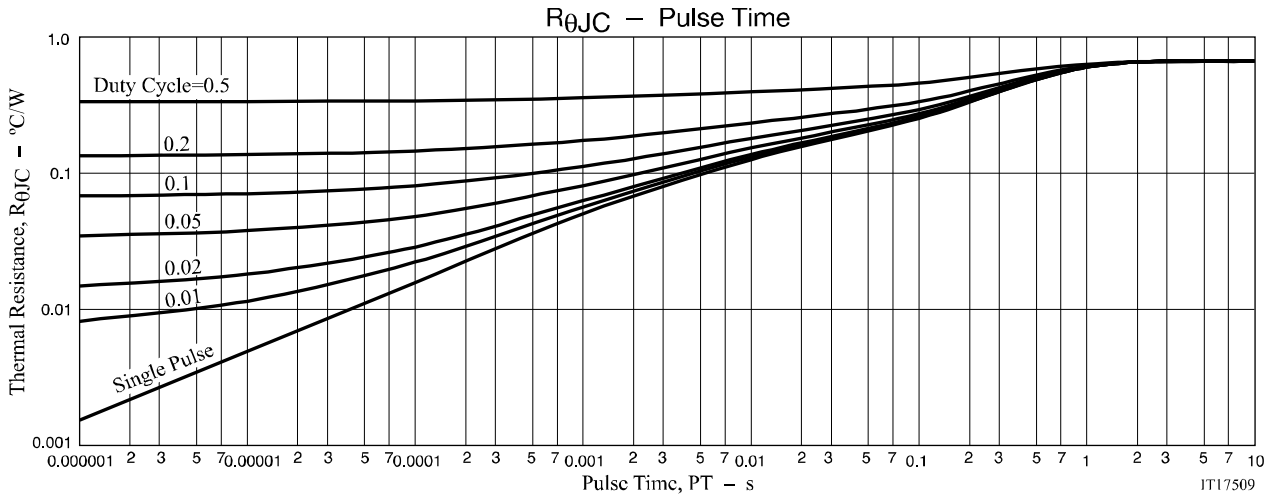

Fig.1 Switching Time Test Circuit

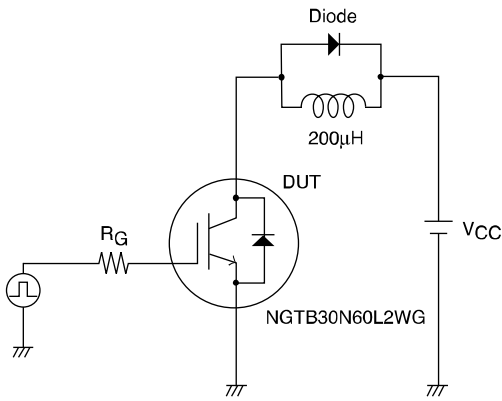

Fig.2 Timing Chart

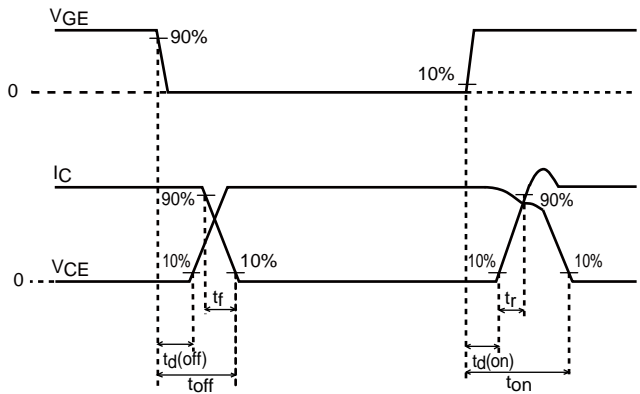
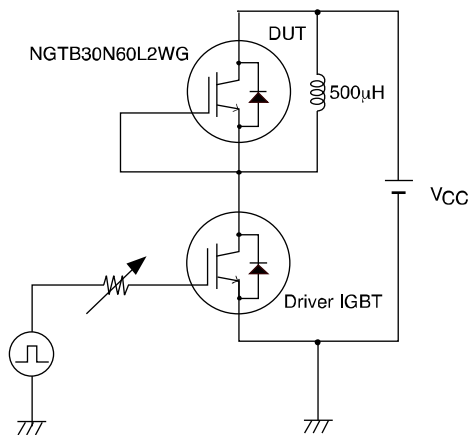

Fig.3 Reverse Recovery Time Test Circuit



NGTB30N60L2WG

Package Dimensions

NGTB30N60L2WG

TO-247

CASE 340AK

ISSUE O

unit : mm

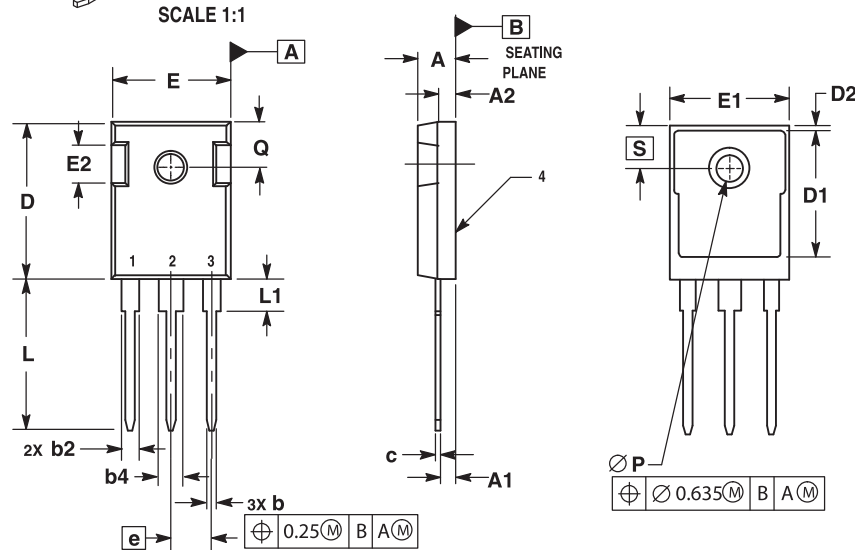
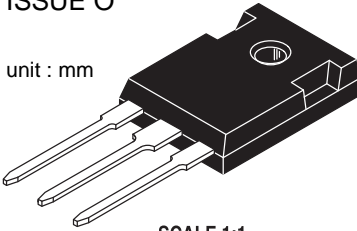

NOTES:

1. DIMENSIONING AND TOLERANCING PER ASME Y14.5M, 1994.
2. CONTROLLING DIMENSION: MILLIMETERS.
3. DIMENSIONS D AND E DO NOT INCLUDE MOLD FLASH. MOLD FLASH SHALL NOT EXCEED 0.13 PER SIDE. THESE DIMENSIONS ARE MEASURED AT THE OUTERMOST EXTREME OF THE PLASTIC BODY.
4. SLOT REQUIRED, NOTCH MAY BE ROUNDED.
5. THERMAL PAD CONTOUR OPTIONAL WITHIN DIMENSIONS D1 AND E1.
6. LEAD FINISH UNCONTROLLED WITHIN L1.
7. ⌀P TO HAVE A MAXIMUM DRAFT ANGLE OF 1.5° TO THE TOP OF THE PART WITH A MAXIMUM DIAMETER OF 3.91.

DIM	MILLIMETERS		INCHES	
	MIN	MAX	MIN	MAX
A	4.70	5.31	0.185	0.209
A1	2.21	2.59	0.087	0.102
A2	1.50	2.49	0.059	0.098
b	1.00	1.40	0.039	0.055
b2	1.65	2.39	0.065	0.094
b4	2.59	3.43	0.102	0.135
c	0.38	0.89	0.015	0.035
D	20.80	21.46	0.819	0.845
D1	13.08	---	0.515	---
D2	0.51	1.35	0.020	0.053
E	15.49	16.26	0.610	0.640
E1	13.46	---	0.53	---
E2	4.32	5.49	0.170	0.216
e	5.46 BSC	---	0.215 BSC	---
L	19.81	20.32	0.780	0.800
L1	---	4.50	---	0.177
P	3.56	3.66	0.140	0.144
Q	5.38	6.20	0.212	0.244
S	6.15 BSC	---	0.242 BSC	---

Ordering & Package Information

Device	Package	Shipping	note
NGTB30N60L2WG	TO-247-3L	30 pcs. / tube	Pb-Free and Halogen Free

ON Semiconductor and the ON logo are registered trademarks of Semiconductor Components Industries, LLC (SCILLC) or its subsidiaries in the United States and/or other countries. SCILLC owns the rights to a number of patents, trademarks, copyrights, trade secrets, and other intellectual property. A listing of SCILLC's product/patent coverage may be accessed at www.onsemi.com/site/pdf/Patent-Marking.pdf. SCILLC reserves the right to make changes without further notice to any products herein. SCILLC makes no warranty, representation or guarantee regarding the suitability of its products for any particular purpose, nor does SCILLC assume any liability arising out of the application or use of any product or circuit, and specifically disclaims any and all liability, including without limitation special, consequential or incidental damages. "Typical" parameters which may be provided in SCILLC data sheets and/or specifications can and do vary in different applications and actual performance may vary over time. All operating parameters, including "Typicals" must be validated for each customer application by customer's technical experts. SCILLC does not convey any license under its patent rights nor the rights of others. SCILLC products are not designed, intended, or authorized for use as components in systems intended for surgical implant into the body, or other applications intended to support or sustain life, or for any other application in which the failure of the SCILLC product could create a situation where personal injury or death may occur. Should Buyer purchase or use SCILLC products for any such unintended or unauthorized application, Buyer shall indemnify and hold SCILLC and its officers, employees, subsidiaries, affiliates, and distributors harmless against all claims, costs, damages, and expenses, and reasonable attorney fees arising out of, directly or indirectly, any claim of personal injury or death associated with such unintended or unauthorized use, even if such claim alleges that SCILLC was negligent regarding the design or manufacture of the part. SCILLC is an Equal Opportunity/Affirmative Action Employer. This literature is subject to all applicable copyright laws and is not for resale in any manner.