



Data Device Corporation

1-800-DDC-5757 | 631-567-5600
105 Wilbur Place, Bohemia, NY 11716
service@ddc-web.com | www.ddc-web.com



NHi-15765/66 NHi-15LV765/66 +5v/+3.3v Monolithic 2Mbit-1553/1760 Transceivers

Features

- Dual Transceiver
- Totally Independent Channels
- Single Power Supply
- Short Circuit Tolerant
- NHi Proprietary ASIC
- Superior Noise Filter

Description

The receivers convert Manchester II bi-phase data into complementary digital outputs. Each receiver has an independent digital enable.

The transmitters convert complementary digital inputs into Manchester II bi-phase data. Each transmitter has an independent digital inhibit.

A coupling transformer interfaces each transceiver to the Stub or Bus.

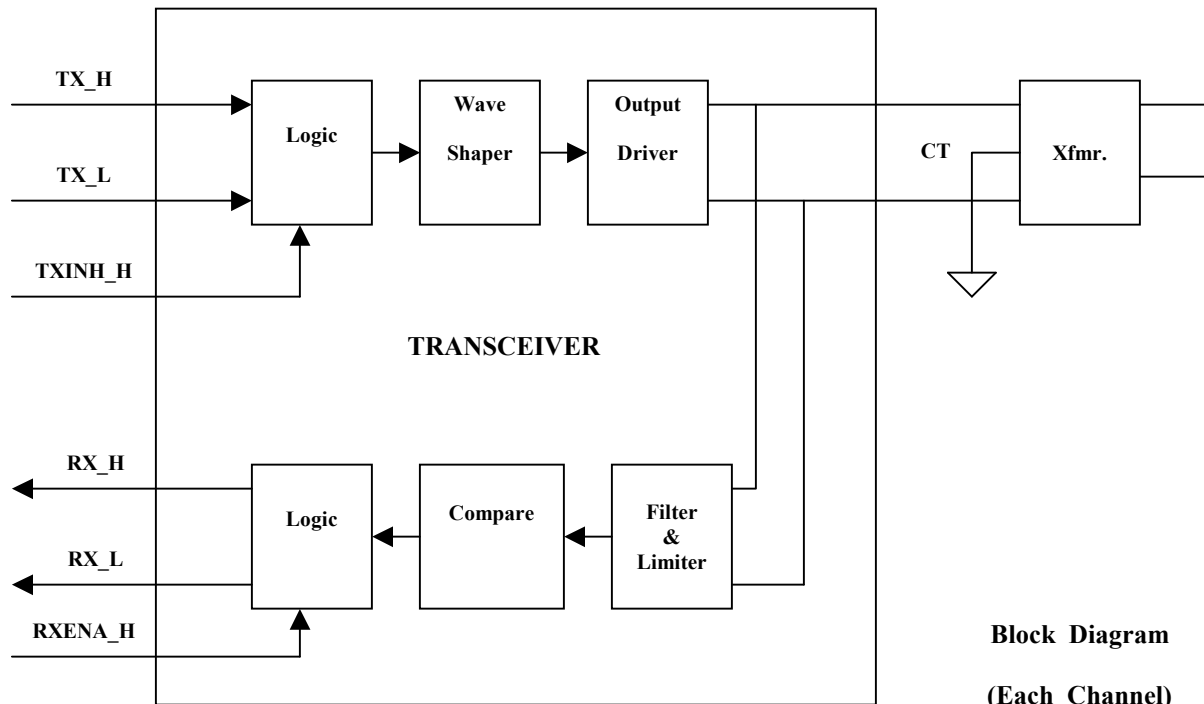

Block Diagram
(Each Channel)

NHi-15765/66 NHi-15LV765/66
+5v/+3.3v Monolithic 2Mbit-1553/1760 Transceivers

ABSOLUTE MAXIMUM RATINGS

Supply Voltage	Symbol	Min	Max	Units	Notes
Power Supply	Vdd_+5.0	-0.3	+7.0	Vdc	1
Power Supply	Vdd_+3.3	-0.3	+3.9	Vdc	1
Receiver Differential Input Voltage	Vdd_+5.0		15	Vpp	1
Receiver Differential Input Voltage	Vdd_+3.3		12	Vpp	1
Peak Transmitter Current	Ipkmax		1.0	A	
Solder Temperature	Tsold		300	DegC	
Storage Temperature	Tstor	-65	+150	DegC	
Lead Temperature	Tlead		+300	DegC	
Input Zapping	Vzap	2000		Vdc	3
Logic Input Current	Ilgc	-10		uA	2

Notes:

- 1. Vdd referenced to ground.**
- 2. Does not include current through internal pullup/pulldown resistors.**
- 3..As defined for ESDS in method 3015 of Mil-Std-883, Class 2.**

NHi-15765/66

General Electrical Specifications

PARAMETER	CONDITION	SYM	MIN	TYP	MAX	UNITS
Power Supply	70 Ohm Load On Stub	Vdd	4.75	5.00	5.25	Vdc
Output Voltage	70 Ohm Load On Stub	Vout	20	22	24	Vpp
Standby Current	Not Transmitting; Total Part	Istby		27	35	mA
100% Duty Cycle	One Channel Transmitting	Idd		590	650	mA
Power Dissipation	Not Transmitting	Pstby		0.135	0.184	W
100% Duty Cycle	One Channel Transmitting	Pd1		1.1	1.4	W
Operating Temperature	Case	Tc	-55		+125	DegC
Thermal Impedance	Junction to Case	θ_{jc}			6	DegC/W
Logic I/O						
Vin High		Vih	2			V
Vin Low		Vil			0.8	V
Iin High	Vih = 2.7v	Iih	20		50	uA
Iin Low	Vil = 0.4v	Iil	-20		-50	uA
Vout High	Ioh = 4ma	Voh	2.3			V
Vout Low	Iol = 4ma	Vol			0.4	V

Transceiver Electrical Specifications

PARAMETER	CONDITION	SYM	MIN	TYP	MAX	UNITS
Rise/Fall Time	Resistive Load On Xfmr	Tr/Tf	90		130	ns
Dynamic Offset	Measured On Stub	Vdo	-250		+250	mv
Output Noise	On Stub; Not Transmitting	Vno			10	mv
Output Impedance	On Stub; Not Transmitting	Zo	3K			Ohms
Input Level	On Stub	Vin			30	Vpp
Receiver Threshold	Referred To Stub	Vthr	400	600	860	mv
Common Mode Rejection	DC To 2Mhz	Cmrr	40			db

NHi-15LV765/66

General Electrical Specifications

PARAMETER	CONDITION	SYM	MIN	TYP	MAX	UNITS
Power Supply		Vdd	3.15	3.30	3.45	Vdc
Output Voltage	70 Ohm Load On Stub	Vout	20	22	24	Vpp
Standby Current	Not Transmitting; Total Part	Istby		27	35	mA
100% Duty Cycle	One Channel Transmitting	Idd1		785	900	mA
Power Dissipation	Not Transmitting	Pstby		.089	.121	W
100% Duty Cycle	One Channel Transmitting	Pd1		.870	1.1	W
Operating Temperature	Case	Tc	-55		+125	DegC
Thermal Impedance	Junction to Case	θjc			6	DegC/W
Logic I/O						
Vin High		Vih	2			V
Vin Low		Vil			0.8	V
Iin High	Vih = 2.7v	Iih	20		50	uA
Iin Low	Vil= 0.4v	Iil	-20		-50	uA
Vout High	Ioh = 4ma	Voh	2.3			V
Vout Low	Iol = 4ma	Vol			0.4	V

Transceiver Electrical Specifications

PARAMETER	CONDITION	SYM	MIN	TYP	MAX	UNITS
Rise/Fall Time	Resistive Load On Xfmr	Tr/Tf	90		130	ns
Dynamic Offset	Measured On Stub	Vdo	-250		+250	mv
Output Noise	On Stub; Not Transmitting	Vno			10	mv
Output Impedance	On Stub; Not Transmitting	Zo	3K			Ohms
Input Level	On Stub	Vin			30	Vpp
Receiver Threshold	Referred To Stub	Vthr	400	600	860	mv
Common Mode Rejection	DC To 2Mhz	Cmrr	40			db

NHi-15765/66 NHi-15LV765/66

Pin Functions

20 Pin Dip/Ep/Soic Package

Pin	Function	Pin	Function
1	Vdd_A	20	Txin_A_L
2	Bus_A_H	19	Txin_A_H
3	Bus_A_L	18	Txena_A_L
4	Rxena_A_H	17	Rxo_A_H
5	Gnd_A	16	Rxo_A_L
6	Vdd_B	15	Txin_B_L
7	Bus_B_H	14	Txin_B_H
8	Bus_B_L	13	Txena_B_L
9	Rxena_B_H	12	Rxo_B_H
10	Gnd_B	11	Rxo_B_L

44 Pin Chip Scale Package

Pin	Function	Pin	Function
1	N/C	44	N/C
2	Rxena_A_H	43	Bus_A_L
3	Gnd_A	42	Bus_A_L
4	Gnd_A	41	Bus_A_H
5	Gnd_A	40	Bus_A_H
6	Vdd_B	39	Vdd_A
7	Vdd_B	38	Vdd_A
8	Bus_B_H	37	Txin_A_L
9	Bus_B_H	36	Txin_A_H
10	Bus_B_L	35	N/C
11	Bus_B_L	34	N/C
12	N/C	33	N/C
13	N/C	32	N/C
14	N/C	31	Txena_A_L
15	N/C	30	Rxo_A_H
16	Rxena_B_H	29	Rxo_A_L
17	Gnd_B	28	N/C
18	Gnd_B	27	N/C
19	Gnd_B	26	Txin_B_L
20	Rxo_B_L	25	Txin_B_H
21	Rxo_B_H	24	Txena_B_L
22	N/C	23	N/C

Power Supply

Part Number	Vdd
NHi-15765/15766	+5v
NHi-15LV765/15LV766	+3.3v

Coupling Transformer Turns Ratio

Part Number	Stub	Direct
NHi-15765/15766	1ct : 1.79ct	1ct : 2.5ct
NHi-15LV765/15LV766	1ct : 2.5ct	1ct :3.54ct

NHi-15765/66 NHi-15LV765/66

Receiver Logic

Part Number	Rxena_H	Stub/Bus	Rxo_H	Rxo_L
NHi-15765/LV765	1	Vthr- <Vpp< +Vthr	0	0
NHi-15765/LV765	1	Vthr- <Vpp>= +Vthr	1	0
	1	Vthr- =>Vpp< +Vthr	0	1
NHi-15765/LV765	0	X	0	0
NHi-15766/LV766	1	Vthr- <Vpp< +Vthr	1	1
NHi-15766/LV766	1	Vthr- <Vpp>= +Vthr	1	0
NHi-15766/LV766	1	Vthr- =>Vpp< +Vthr	0	1
	0	X	1	1

Transmitter Logic

Txin_H	Txin_L	Txena_L	Stub/Bus
0	0	0	Hi_Z
1	0	0	Vpp
0	1	0	Vpp
1	1	0	Hi_Z
X	X	1	Hi_Z

NHi-15765/66

FLAT PACKAGE

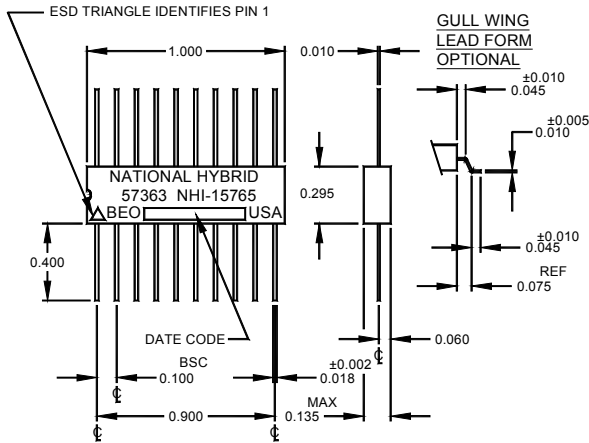

DUAL IN-LINE PACKAGE

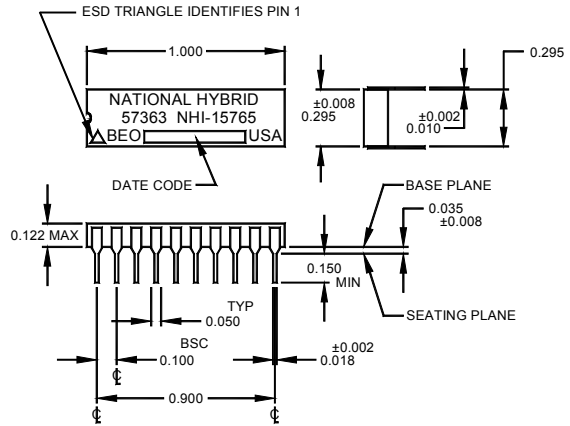

NHi-15LV765/66

FLAT PACKAGE

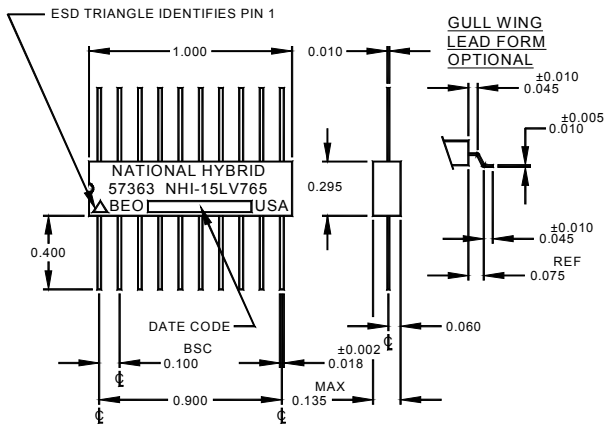

DUAL IN-LINE PACKAGE

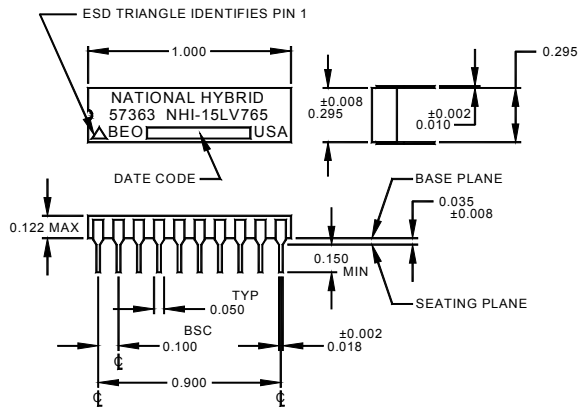

NHi-15765/66

ALL DIMENSIONS ARE IN mm.

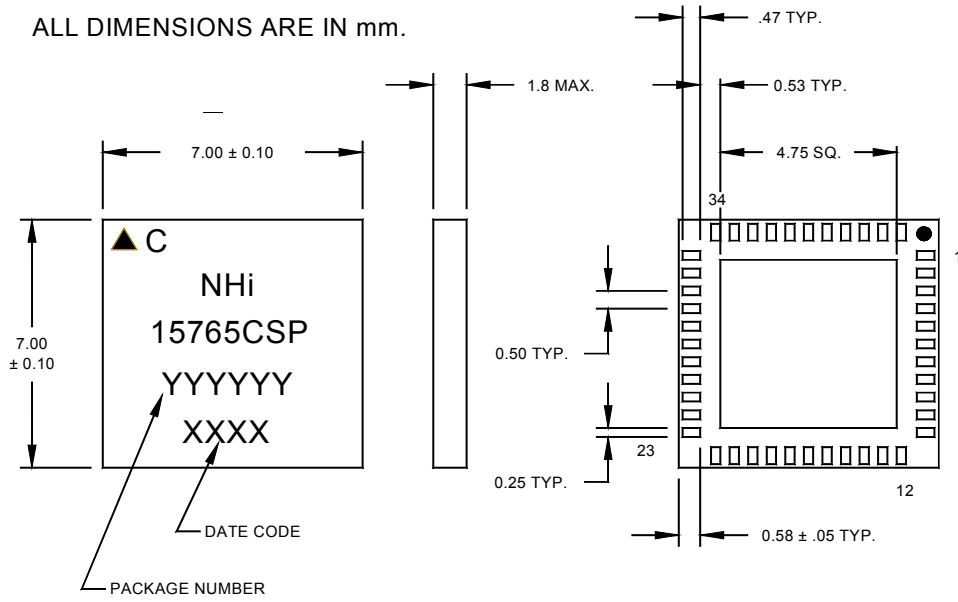

NHi-15LV765/66

ALL DIMENSIONS ARE IN mm.

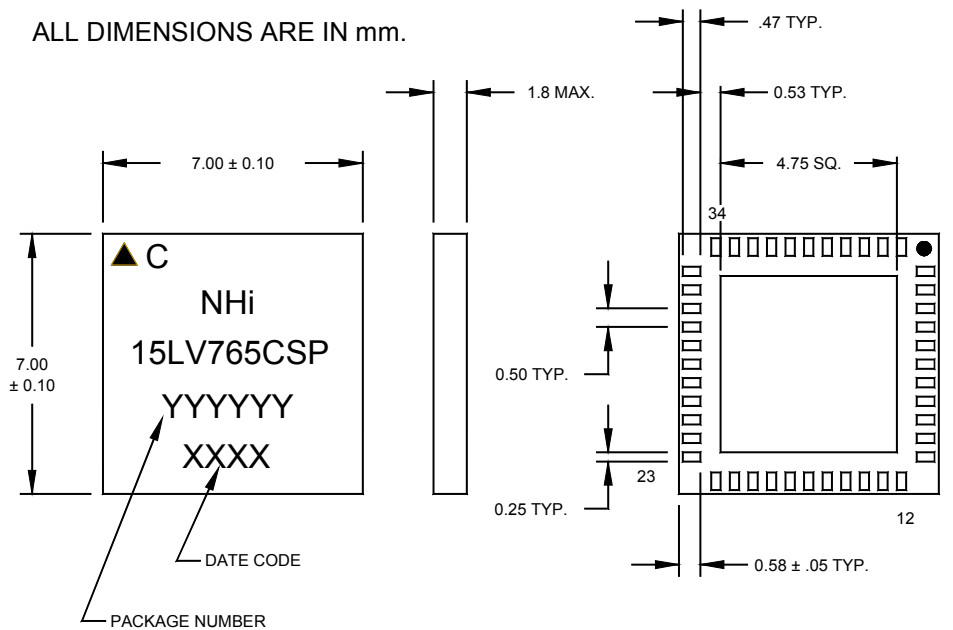

NHi-15765/66

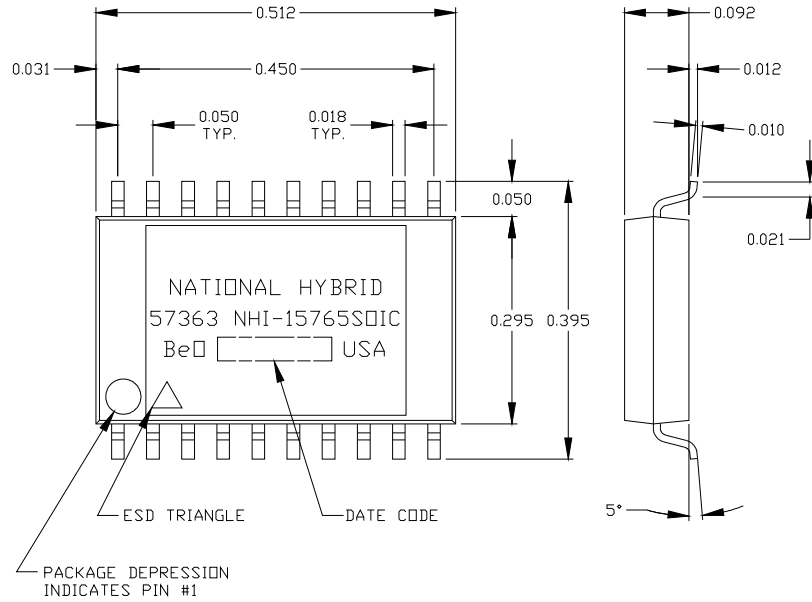

ALL DIMENSIONS ARE IN INCHES

NHi-15LV765/66

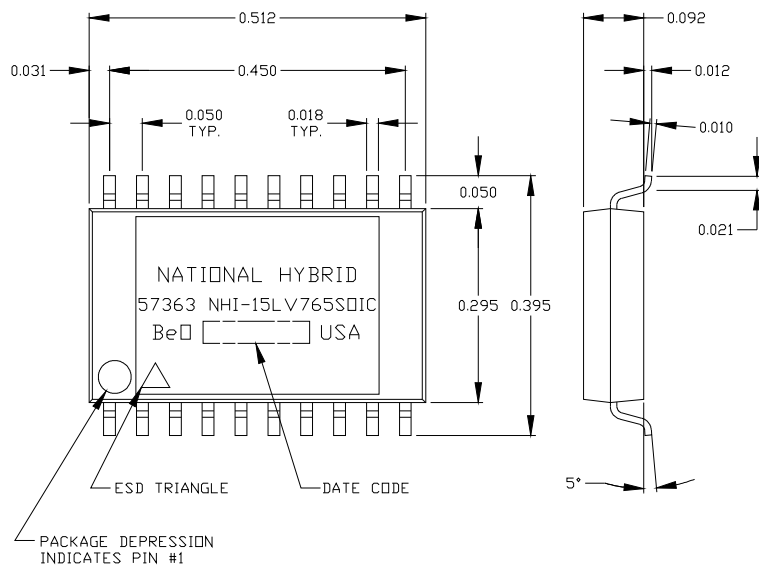

ALL DIMENSIONS ARE IN INCHES

Ordering Information

NHi-15LV765CSP/T

