

Machine Automation Controller NJ-series

Troubleshooting Manual

NJ501-1500

NJ501-1400

NJ501-1300

NJ301-1200

NJ301-1100

© **OMRON, 2011**

All rights reserved. No part of this publication may be reproduced, stored in a retrieval system, or transmitted, in any form, or by any means, mechanical, electronic, photocopying, recording, or otherwise, without the prior written permission of OMRON.

No patent liability is assumed with respect to the use of the information contained herein. Moreover, because OMRON is constantly striving to improve its high-quality products, the information contained in this manual is subject to change without notice. Every precaution has been taken in the preparation of this manual. Nevertheless, OMRON assumes no responsibility for errors or omissions. Neither is any liability assumed for damages resulting from the use of the information contained in this publication.

Introduction

Thank you for purchasing an NJ-series CPU Unit.

This manual contains information that is necessary to use the NJ-series CPU Unit. Please read this manual and make sure you understand the functionality and performance of the NJ-series CPU Unit before you attempt to use it in a control system.

Keep this manual in a safe place where it will be available for reference during operation.

Intended Audience

This manual is intended for the following personnel, who must also have knowledge of electrical systems (an electrical engineer or the equivalent).

- Personnel in charge of introducing FA systems.
- Personnel in charge of designing FA systems.
- Personnel in charge of installing and maintaining FA systems.
- Personnel in charge of managing FA systems and facilities.

For programming, this manual is intended for personnel who understand the programming language specifications in international standard IEC 61131-3 or Japanese standard JIS B3503.

Applicable Products

This manual covers the following products.

- NJ-series CPU Units
 - NJ501-1500
 - NJ501-1400
 - NJ501-1300
 - NJ301-1200
 - NJ301-1100

Relevant Manuals

There are three manuals that provide basic information on the NJ-series CPU Units: the *NJ-series CPU Unit Hardware User's Manual*, the *NJ-series CPU Unit Software User's Manual*, and the *NJ-series Instructions Reference Manual*.

Most operations are performed from the Sysmac Studio Automation Software. Refer to the *Sysmac Studio Version 1 Operation Manual* (Cat. No. W504) for information on the Sysmac Studio.

Other manuals are necessary for specific system configurations and applications.

Read all of the manuals that are relevant to your system configuration and application to make the most of the NJ-series CPU Unit.

	NJ-series User's Manuals								
	Basic information								CJ-series Special Unit Operation Manuals for NJ-series CPU Unit
	NJ-series CPU Unit Hardware User's Manual	NJ-series CPU Unit Software User's Manual	NJ-series Instructions Reference Manual	NJ-series CPU Unit Motion Control User's Manual	NJ-series CPU Unit Built-in EtherCAT Port User's Manual	NJ-series Motion Control Instructions Reference Manual	NJ-series CPU Unit Built-in EtherNet/IP Port User's Manual	NJ-series Troubleshooting Manual	
Introduction to NJ-series Controllers	●								
Setting devices and hardware									
Using motion control				●					
Using EtherCAT	●				●				
Using EtherNet/IP							●		
Using CJ-series Units								●	
Software settings									
Using motion control		●		●					
Using EtherCAT					●				
Using EtherNet/IP							●		
Programming		●	●						
Using motion control				●		●			
Using EtherCAT					●				
Using CJ-series Units								●	
Programming error processing								●	
Testing operation and debugging									
Using motion control		●		●					
Using EtherCAT					●				
Using EtherNet/IP							●		
Troubleshooting and managing errors in an NJ-series Controller	△	△		△			△	●	
Use the relevant manuals for references according to any error that occurs.									
Maintenance									
Using EtherCAT	●				●				
Using EtherNet/IP							●		
Using CJ-series Units								●	

Manual Configuration

NJ-series CPU Unit Hardware User's Manual (Cat. No. W500)

Section	Description
Section 1 Introduction	This section provides an introduction to the NJ-series Controllers and their features, and gives the NJ-series Controller specifications.
Section 2 System Configuration	This section describes the system configuration used for NJ-series Controllers.
Section 3 Configuration Units	This section describes the parts and functions of the configuration devices in the NJ-series Controller configuration, including the CPU Unit and Configuration Units.
Section 4 Installation and Wiring	This section describes where and how to install the CPU Unit and Configuration Units and how to wire them.
Section 5 Troubleshooting	This section describes the event codes, error confirmation methods, and corrections for errors that can occur.
Section 6 Inspection and Maintenance	This section describes the contents of periodic inspections, the service life of the Battery and Power Supply Units, and replacement methods for the Battery and Power Supply Units.
Appendices	The appendices provide the specifications of the Basic I/O Units, Unit dimensions, load short-circuit protection detection, line disconnection detection, and measures for EMC Directives.

NJ-series CPU Unit Software User's Manual (Cat. No. W501)

Section	Description
Section 1 Introduction	This section provides an introduction to the NJ-series Controllers and their features, and gives the NJ-series Controller specifications.
Section 2 CPU Unit Operation	This section describes the variables and control systems of the CPU Unit and CPU Unit status.
Section 3 I/O Ports, Slave Configuration, and Unit Configuration	This section describes how to use I/O ports, how to create the slave configuration and unit configuration and how to assign functions.
Section 4 Controller Setup	This section describes the initial settings of the function modules.
Section 5 Designing Tasks	This section describes the task system and types of tasks.
Section 6 Programming	This section describes programming, including the programming languages and the variables and instructions that are used in programming.
Section 7 Checking Operation and Actual Operation	This section describes the items and procedures for checking the operation of an NJ-series Controller, including offline debugging procedures.
Section 8 CPU Unit Status	This section describes CPU Unit status.
Section 9 CPU Unit Functions	This section describes the functionality provided by the CPU Unit.
Section 10 Communications Setup	This section describes how to go online with the CPU Unit and how to connect to other devices.
Section 11 Example of Actual Application Procedures	This section describes the procedures that are used to actually operate an NJ-series Controller.
Section 12 Troubleshooting	This section describes the event codes, error confirmation methods, and corrections for errors that can occur.
Appendices	The appendices provide the CPU Unit specifications, task execution times, system-defined variable lists, data attribute lists, CJ-series Unit memory information, CJ-series Unit memory allocation methods, and data type conversion information.

NJ-series Troubleshooting Manual (Cat. No. W503) (This Manual)

Section	Description
Section 1 Overview of Errors	This section describes the errors that can occur on an NJ-series Controller, the operation that occurs for errors, and methods to confirm errors.
Section 2 Error Troubleshooting Methods	This section describes how to handle errors.
Section 3 Error Tables	This section lists all of the error events that can occur on NJ-series Controllers.

Sysmac Studio Version 1 Operation Manual (Cat. No. W504)

Section	Description
Section 1 Introduction	This section provides an overview and lists the specifications of the Sysmac Studio and describes its features and components.
Section 2 Installation and Uninstallation	This section describes how to install and uninstall the Sysmac Studio.
Section 3 System Design	This section describes the basic concepts for designing an NJ-series System with the Sysmac Studio and the basic operating procedures.
Section 4 Programming	This section describes how to create programs with the Sysmac Studio.
Section 5 Online Connections to a Controller	This section describes how to go online with a Controller.
Section 6 Debugging	This section describes how to debug the programs online on the Controller or debug it offline with the Simulator.
Section 7 Other Functions	This section describes other functions that are supported by the Sysmac Studio, including security functions and troubleshooting functions.
Section 8 Reusing Programming	This section describes how to reuse the programs that you create with the Sysmac Studio.
Section 9 Support Software Provided with the Sysmac Studio	This section describes the Support Software that is provided with the Sysmac Studio.
Section 10 Troubleshooting	This section describes the error messages that are displayed when you check a program on the Sysmac Studio and how to correct those errors.
Appendices	The appendices describe the following: Driver Installation for Direct USB Cable Connection Specifying One of Multiple Ethernet Interface Cards Online Help Simulation Instructions

Manual Structure

Page Structure

The following page structure is used in this manual.

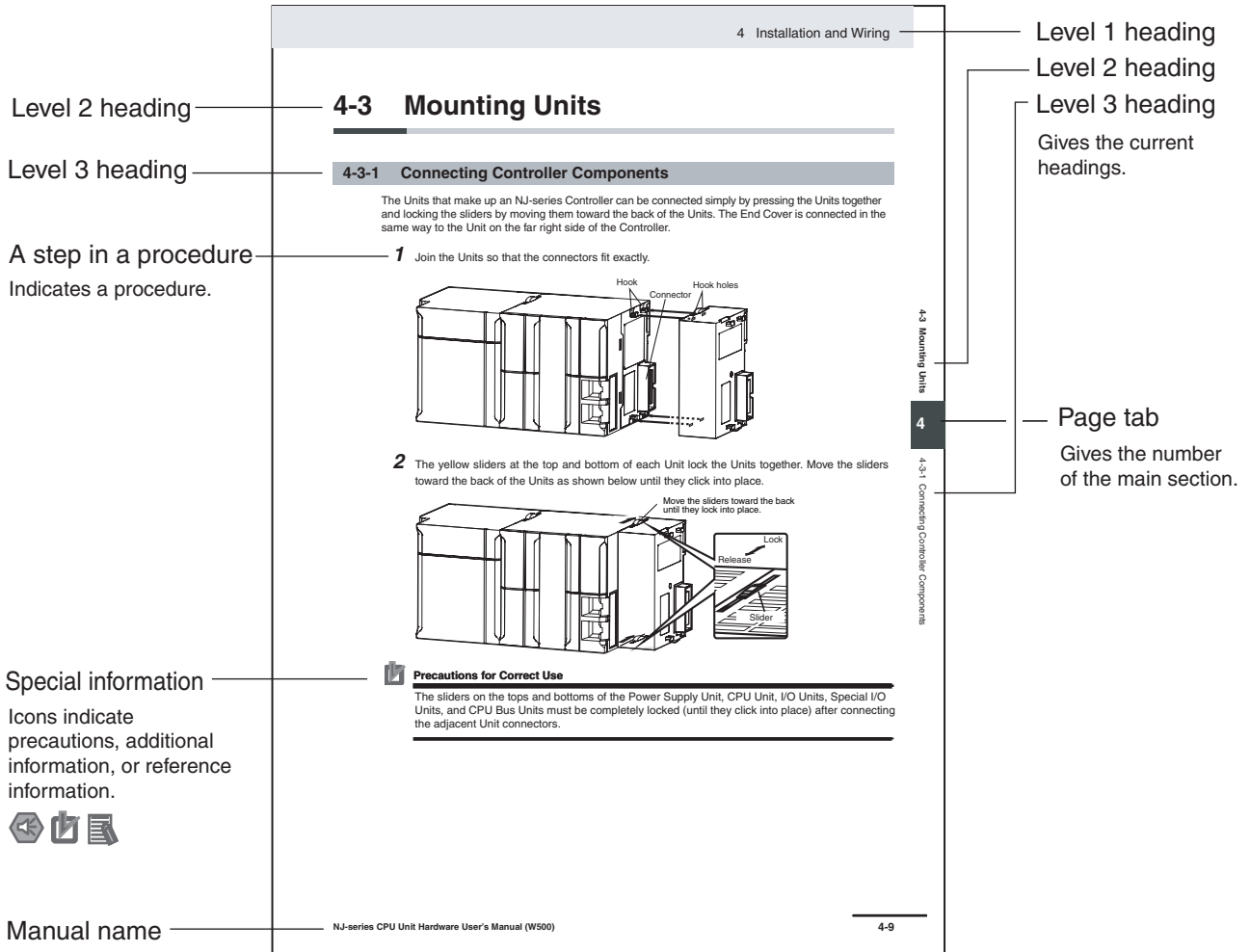

This illustration is provided only as a sample. It may not literally appear in this manual.

Special Information

Special information in this manual is classified as follows:



Precautions for Safe Use

Precautions on what to do and what not to do to ensure safe usage of the product.



Precautions for Correct Use

Precautions on what to do and what not to do to ensure proper operation and performance.



Additional Information

Additional information to read as required.

This information is provided to increase understanding or make operation easier.

Note References are provided to more detailed or related information.

Precaution on Terminology

In this manual, “download” refers to transferring data from the Sysmac Studio to the physical Controller and “upload” refers to transferring data from the physical Controller to the Sysmac Studio.

For the Sysmac Studio, synchronization is used to both upload and download data. Here, “synchronize” means to automatically compare the data for the Sysmac Studio on the computer with the data in the physical Controller and transfer the data in the direction that is specified by the user.

Sections in this Manual

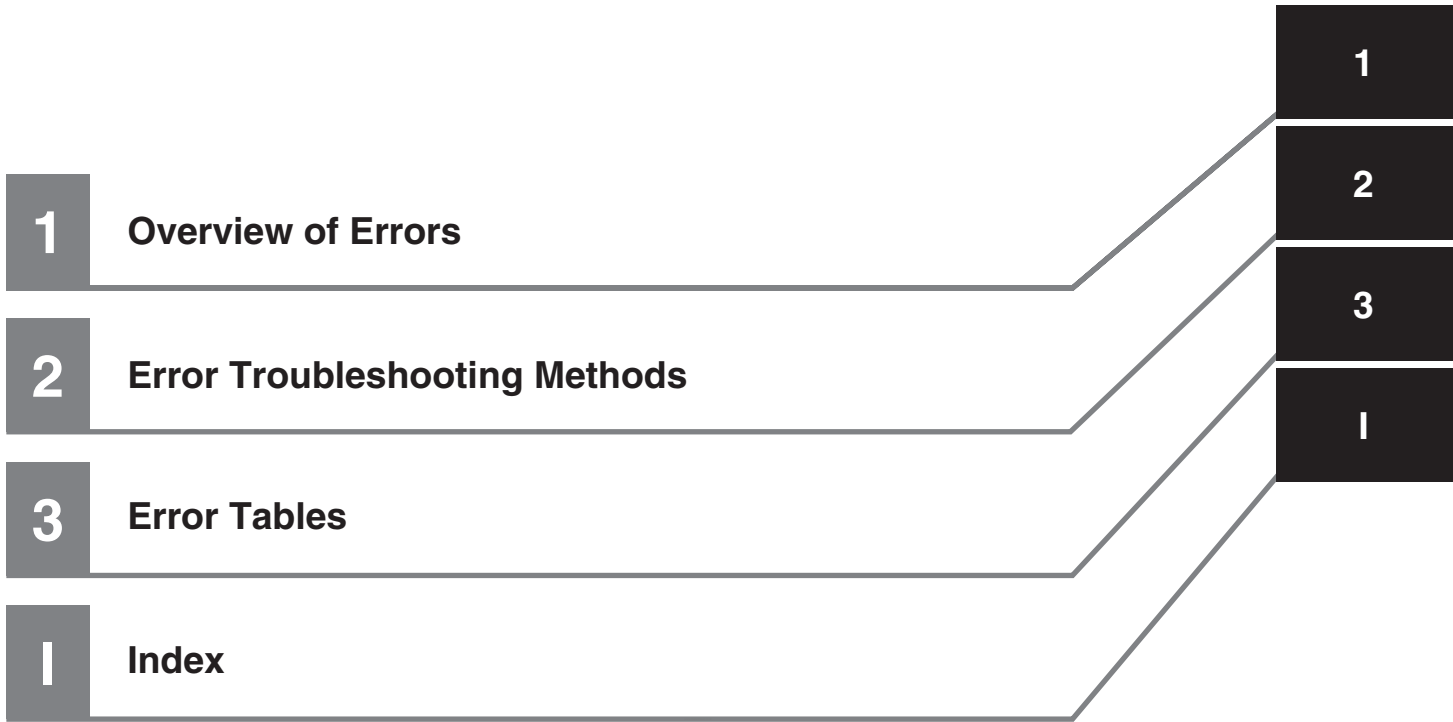

CONTENTS

Introduction	1
Relevant Manuals.....	2
Manual Configuration	3
Manual Structure	5
Sections in this Manual.....	7
Read and Understand this Manual	11
Safety Precautions	15
Precautions for Safe Use	17
Precautions for Correct Use	18
Regulations and Standards	19
Unit Versions.....	21
Related Manuals	24
Revision History	26

Section 1 Overview of Errors

1-1 Overview of NJ-series Errors	1-2
1-1-1 Types of Errors.....	1-2
1-1-2 CPU Unit Status.....	1-3
1-2 Fatal Errors.....	1-4
1-2-1 Types of Fatal Errors.....	1-4
1-2-2 Checking for Fatal Errors	1-4
1-3 Non-fatal Errors	1-5
1-3-1 Types of Non-fatal Errors	1-5
1-3-2 Checking for Non-fatal Errors	1-11
1-3-3 Resetting Non-fatal Errors	1-13

Section 2 Error Troubleshooting Methods

2-1 Troubleshooting Flowcharts.....	2-2
2-1-1 Checking to See If the CPU Unit Is Operating.....	2-2
2-1-2 Troubleshooting Flowchart for Non-fatal Errors	2-3
2-2 Troubleshooting Fatal Errors.....	2-4
2-3 Troubleshooting Non-fatal Errors	2-5
2-3-1 Identifying and Resetting Errors with the Sysmac Studio.....	2-5
2-3-2 Identifying and Resetting Errors with an NS-series PT	2-9
2-3-3 Identifying and Resetting Errors from the User Program.....	2-11
2-3-4 Checking for Errors with System-defined Variables.....	2-13

2-4 Troubleshooting When You Cannot Go Online from the Sysmac Studio..... 2-14
 2-4-1 Causes and Correction When You Cannot Go Online from the Sysmac Studio 2-14
 2-4-2 Troubleshooting for Each Cause 2-15

Section 3 Error Tables

3-1 Errors by Source..... 3-2
 3-1-1 Interpreting Error Descriptions 3-2
 3-1-2 Errors in the PLC Function Module 3-2
 3-1-3 Errors in the Motion Control Function Module..... 3-11
 3-1-4 Errors in the EtherNet/IP Function Module 3-37
 3-1-5 Errors in the EtherCAT Master Function Module..... 3-41
 3-1-6 Errors in EtherCAT Slaves..... 3-44
 3-1-7 Errors in CJ-series Units 3-60

3-2 Events in Order of Event Codes..... 3-79
 3-2-1 Interpreting Error Descriptions 3-79
 3-2-2 Error Table..... 3-80

3-3 Instruction Error Table 3-98
 3-3-1 Interpreting Error Descriptions 3-98
 3-3-2 Error Table..... 3-98

Index

Read and Understand this Manual

Please read and understand this manual before using the product. Please consult your OMRON representative if you have any questions or comments.

Warranty and Limitations of Liability

WARRANTY

OMRON's exclusive warranty is that the products are free from defects in materials and workmanship for a period of one year (or other period if specified) from date of sale by OMRON.

OMRON MAKES NO WARRANTY OR REPRESENTATION, EXPRESS OR IMPLIED, REGARDING NON-INFRINGEMENT, MERCHANTABILITY, OR FITNESS FOR PARTICULAR PURPOSE OF THE PRODUCTS. ANY BUYER OR USER ACKNOWLEDGES THAT THE BUYER OR USER ALONE HAS DETERMINED THAT THE PRODUCTS WILL SUITABLY MEET THE REQUIREMENTS OF THEIR INTENDED USE. OMRON DISCLAIMS ALL OTHER WARRANTIES, EXPRESS OR IMPLIED.

LIMITATIONS OF LIABILITY

OMRON SHALL NOT BE RESPONSIBLE FOR SPECIAL, INDIRECT, OR CONSEQUENTIAL DAMAGES, LOSS OF PROFITS OR COMMERCIAL LOSS IN ANY WAY CONNECTED WITH THE PRODUCTS, WHETHER SUCH CLAIM IS BASED ON CONTRACT, WARRANTY, NEGLIGENCE, OR STRICT LIABILITY.

In no event shall the responsibility of OMRON for any act exceed the individual price of the product on which liability is asserted.

IN NO EVENT SHALL OMRON BE RESPONSIBLE FOR WARRANTY, REPAIR, OR OTHER CLAIMS REGARDING THE PRODUCTS UNLESS OMRON'S ANALYSIS CONFIRMS THAT THE PRODUCTS WERE PROPERLY HANDLED, STORED, INSTALLED, AND MAINTAINED AND NOT SUBJECT TO CONTAMINATION, ABUSE, MISUSE, OR INAPPROPRIATE MODIFICATION OR REPAIR.

Application Considerations

SUITABILITY FOR USE

OMRON shall not be responsible for conformity with any standards, codes, or regulations that apply to the combination of products in the customer's application or use of the products.

At the customer's request, OMRON will provide applicable third party certification documents identifying ratings and limitations of use that apply to the products. This information by itself is not sufficient for a complete determination of the suitability of the products in combination with the end product, machine, system, or other application or use.

The following are some examples of applications for which particular attention must be given. This is not intended to be an exhaustive list of all possible uses of the products, nor is it intended to imply that the uses listed may be suitable for the products:

- Outdoor use, uses involving potential chemical contamination or electrical interference, or conditions or uses not described in this manual.
- Nuclear energy control systems, combustion systems, railroad systems, aviation systems, medical equipment, amusement machines, vehicles, safety equipment, and installations subject to separate industry or government regulations.
- Systems, machines, and equipment that could present a risk to life or property.

Please know and observe all prohibitions of use applicable to the products.

NEVER USE THE PRODUCTS FOR AN APPLICATION INVOLVING SERIOUS RISK TO LIFE OR PROPERTY WITHOUT ENSURING THAT THE SYSTEM AS A WHOLE HAS BEEN DESIGNED TO ADDRESS THE RISKS, AND THAT THE OMRON PRODUCTS ARE PROPERLY RATED AND INSTALLED FOR THE INTENDED USE WITHIN THE OVERALL EQUIPMENT OR SYSTEM.

PROGRAMMABLE PRODUCTS

OMRON shall not be responsible for the user's programming of a programmable product, or any consequence thereof.

Disclaimers

CHANGE IN SPECIFICATIONS

Product specifications and accessories may be changed at any time based on improvements and other reasons.

It is our practice to change model numbers when published ratings or features are changed, or when significant construction changes are made. However, some specifications of the products may be changed without any notice. When in doubt, special model numbers may be assigned to fix or establish key specifications for your application on your request. Please consult with your OMRON representative at any time to confirm actual specifications of purchased products.

DIMENSIONS AND WEIGHTS

Dimensions and weights are nominal and are not to be used for manufacturing purposes, even when tolerances are shown.

PERFORMANCE DATA

Performance data given in this manual is provided as a guide for the user in determining suitability and does not constitute a warranty. It may represent the result of OMRON's test conditions, and the users must correlate it to actual application requirements. Actual performance is subject to the OMRON Warranty and Limitations of Liability.

ERRORS AND OMISSIONS

The information in this manual has been carefully checked and is believed to be accurate; however, no responsibility is assumed for clerical, typographical, or proofreading errors, or omissions.

Safety Precautions

Definition of Precautionary Information

The following notation is used in this manual to provide precautions required to ensure safe usage of the NJ-series Controller. The safety precautions that are provided are extremely important to safety. Always read and heed the information provided in all safety precautions.

The following notation is used.

Refer to the following manuals for precautions for the safe use of the NJ-series Controller.

Installation precautions are also provided for the NJ-series CPU Unit and the NJ-series Controller system.

- NJ-series CPU Unit Hardware User's Manual (W500)
- NJ-series CPU Unit Software User's Manual (W501)



WARNING

Indicates a potentially hazardous situation which, if not avoided, could result in death or serious injury. Additionally, there may be severe property damage.



Caution

Indicates a potentially hazardous situation which, if not avoided, may result in minor or moderate injury, or property damage.



Precautions for Safe Use

Indicates precautions on what to do and what not to do to ensure safe usage of the product.



Precautions for Correct Use

Indicates precautions on what to do and what not to do to ensure proper operation and performance.

Symbols



The circle and slash symbol indicates operations that you must not do. The specific operation is shown in the circle and explained in text. This example indicates prohibiting disassembly.



The triangle symbol indicates precautions (including warnings). The specific operation is shown in the triangle and explained in text. This example indicates a precaution for electric shock.



The triangle symbol indicates precautions (including warnings). The specific operation is shown in the triangle and explained in text. This example indicates a general precaution.



The filled circle symbol indicates operations that you must do. The specific operation is shown in the circle and explained in text. This example shows a general precaution for something that you must do.

Precautions for Safe Use

Refer to the following manuals for precautions for the safe use of the NJ-series Controller. Installation precautions are also provided for the NJ-series CPU Unit and the NJ-series Controller system.

- NJ-series CPU Unit Hardware User's Manual (W500)
- NJ-series CPU Unit Software User's Manual (W501)

Precautions for Correct Use

Refer to the following manuals for precautions for the correct use of the NJ-series Controller. Installation precautions are also provided for the NJ-series CPU Unit and the NJ-series Controller system.

- NJ-series CPU Unit Hardware User's Manual (W500)
- NJ-series CPU Unit Software User's Manual (W501)

Regulations and Standards

Conformance to EC Directives

Applicable Directives

- EMC Directives
- Low Voltage Directive

Concepts

● EMC Directive

OMRON devices that comply with EC Directives also conform to the related EMC standards so that they can be more easily built into other devices or the overall machine. The actual products have been checked for conformity to EMC standards.*

Whether the products conform to the standards in the system used by the customer, however, must be checked by the customer. EMC-related performance of the OMRON devices that comply with EC Directives will vary depending on the configuration, wiring, and other conditions of the equipment or control panel on which the OMRON devices are installed. The customer must, therefore, perform the final check to confirm that devices and the overall machine conform to EMC standards.

* Applicable EMC (Electromagnetic Compatibility) standards are as follows:

EMS (Electromagnetic Susceptibility): EN 61131-2 and EN 61000-6-2

EMI (Electromagnetic Interference): EN 61131-2 and EN 61000-6-4 (Radiated emission: 10-m regulations)

● Low Voltage Directive

Always ensure that devices operating at voltages of 50 to 1,000 VAC and 75 to 1,500 VDC meet the required safety standards. The applicable directive is EN 61131-2.

● Conformance to EC Directives

The NJ-series Controllers comply with EC Directives. To ensure that the machine or device in which the NJ-series Controller is used complies with EC Directives, the Controller must be installed as follows:

- The NJ-series Controller must be installed within a control panel.
- You must use reinforced insulation or double insulation for the DC power supplies connected to DC Power Supply Units and I/O Units.
- NJ-series Controllers that comply with EC Directives also conform to the Common Emission Standard (EN 61000-6-4). Radiated emission characteristics (10-m regulations) may vary depending on the configuration of the control panel used, other devices connected to the control panel, wiring, and other conditions.

You must therefore confirm that the overall machine or equipment complies with EC Directives.

Conformance to Shipbuilding Standards

The NJ-series Controllers comply with the following shipbuilding standards. Applicability to the shipbuilding standards is based on certain usage conditions. It may not be possible to use the product in some locations. Contact your OMRON representative before attempting to use a Controller on a ship.

Usage Conditions for NK and LR Shipbuilding Standards

- The NJ-series Controller must be installed within a control panel.
- Gaps in the door to the control panel must be completely filled or covered with gaskets or other material.
- The following noise filter must be connected to the power supply line.

Noise Filter

Manufacturer	Model
Cosel Co., Ltd.	TAH-06-683

Trademarks

- Sysmac and SYSMAC are trademarks or registered trademarks of OMRON Corporation in Japan and other countries for OMRON factory automation products.
- Windows, Windows 98, Windows XP, Windows Vista, and Windows 7 are registered trademarks of Microsoft Corporation in the USA and other countries.
- EtherCAT® is a registered trademark of Beckhoff Automation GmbH for their patented technology.
- The SD logo is a trademark of SD-3C, LLC. 

Other company names and product names in this document are the trademarks or registered trademarks of their respective companies.

Software Licenses and Copyrights

This product incorporates certain third party software. The license and copyright information associated with this software is available at http://www.fa.omron.co.jp/nj_info_e/.

Unit Versions

Unit Versions

A “unit version” has been introduced to manage CPU Units in the NJ Series according to differences in functionality accompanying Unit upgrades.

Notation of Unit Versions on Products

The unit version is given on the ID information label of the products for which unit versions are managed, as shown below.

Example for NJ-series NJ501-□□□□ CPU Unit:

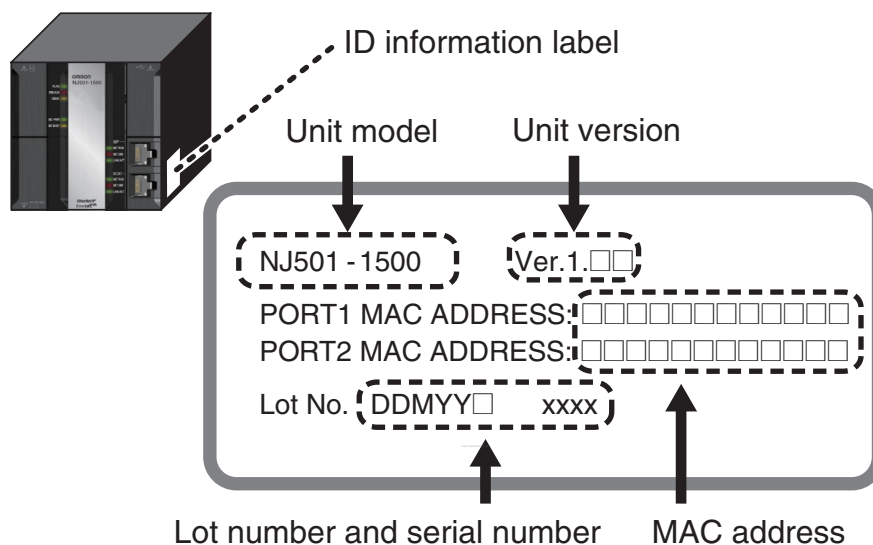

The following information is provided on the ID information label.

Item	Description
Unit model	Gives the model of the Unit.
Unit version	Gives the unit version of the Unit.
Lot number and serial number	Gives the lot number and serial number of the Unit. DDMY: Lot number, □: For use by OMRON, xxxx: Serial number “M” gives the month (1 to 9: January to September, X: October, Y: November, Z: December)
MAC address	Gives the MAC address of the built-in port on the Unit.

Confirming Unit Versions with Sysmac Studio

You can use the Unit Production Information on the Sysmac Studio to check the unit version of the CPU Unit, CJ-series Special I/O Units, CJ-series CPU Bus Units, and EtherCAT slaves. The unit versions of CJ-series Basic I/O Units cannot be checked from the Sysmac Studio.

● CPU Unit and CJ-series Units

- 1 Double-click **CPU/Expansion Racks** under **Configurations and Setup** in the Multiview Explorer. Or, right-click **CPU/Expansion Racks** under **Configurations and Setup** and select **Edit** from the menu.

The Unit Editor is displayed for the Controller Configurations and Setup layer.

- 2 Right-click any open space in the Unit Editor and select **Production Information**.
The Production Information Dialog Box is displayed.

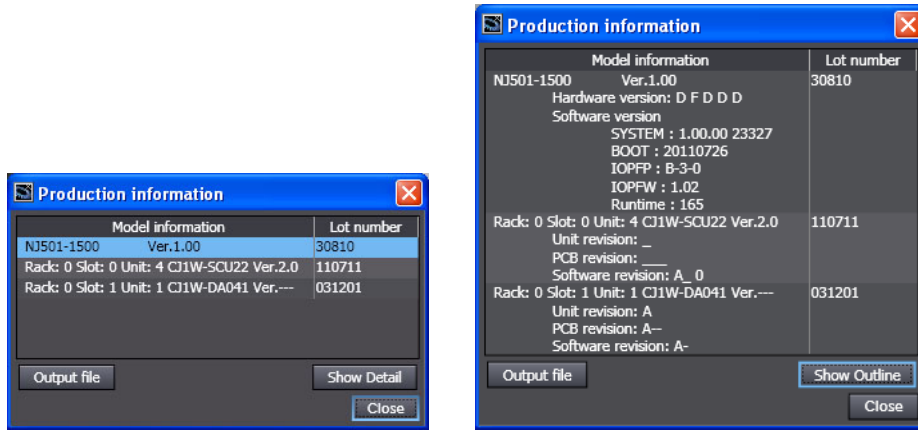

Simple Display

Detailed Display

In this example, "Ver.1.00" is displayed next to the unit model.

The following items are displayed.

CPU Unit	CJ-series Units
Unit model	Unit model
Unit version	Unit version
Lot number	Lot number
	Rack number, slot number, and unit number

● EtherCAT Slaves

- 1 Double-click **EtherCAT** under **Configurations and Setup** in the Multiview Explorer. Or, right-click **EtherCAT** under **Configurations and Setup** and select **Edit** from the menu.
The EtherCAT Configuration Tab Page is displayed for the Controller Configurations and Setup layer.
- 2 Right-click the master in the EtherCAT Configurations Editing Pane and select **Display Production Information**.
The Production Information Dialog Box is displayed.

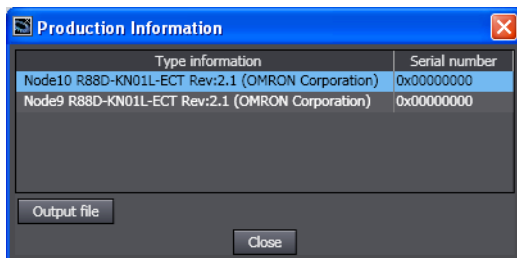

The following items are displayed.

- Node address
- Type information*
- Serial number

* If the model number cannot be determined (such as when there is no ESI file), the vendor ID, product code, and revision number are displayed.

Unit Versions and Sysmac Studio Versions

The events that can occur depend on the unit versions of the NJ-series CPU Unit and the EtherCAT slaves. You must use the corresponding version of Sysmac Studio to display events that were added for version upgrades when troubleshooting from the Sysmac Studio or from the Troubleshooter on an NS-series PT. Refer to the product manuals for information on the unit versions of the CPU Unit and EtherCAT slaves, and for the relationship with the version of the Sysmac Studio.

Unit Version Notation

In this manual, unit versions are specified as shown in the following table.

Product nameplate	Notation in this manual	Remarks
"Ver.1.0" or later to the right of the lot number	Unit version 1.0 or later	Unless unit versions are specified, the information in this manual applies to all unit versions.

Related Manuals

The following manuals are related to the NJ-series Controllers. Use these manuals for reference.

Manual name	Cat. No.	Model numbers	Application	Description
NJ-series CPU Unit Hardware User's Manual	W500	NJ501-□□□□ NJ301-□□□□	Learning the basic specifications of the NJ-series CPU Units, including introductory information, designing, installation, and maintenance. Mainly hardware information is provided.	An introduction to the entire NJ-series system is provided along with the following information on the CPU Unit. <ul style="list-style-type: none"> • Features and system configuration • Introduction • Part names and functions • General specifications • Installation and wiring • Maintenance and inspection Use this manual together with the <i>NJ-series CPU Unit Software User's Manual</i> (Cat. No. W501).
NJ-series CPU Unit Software User's Manual	W501	NJ501-□□□□ NJ301-□□□□	Learning how to program and set up an NJ-series CPU Unit. Mainly software information is provided.	The following information is provided on a Controller built with an NJ501 CPU Unit. <ul style="list-style-type: none"> • CPU Unit operation • CPU Unit features • Initial settings • Programming based on IEC 61131-3 language specifications Use this manual together with the <i>NJ-series CPU Unit Hardware User's Manual</i> (Cat. No. W500).
NJ-series CPU Unit Motion Control User's Manual	W507	NJ501-□□□□ NJ301-□□□□	Learning about motion control settings and programming concepts.	The settings and operation of the CPU Unit and programming concepts for motion control are described. Use this manual together with the <i>NJ-series CPU Unit Hardware User's Manual</i> (Cat. No. W500) and <i>NJ-series CPU Unit Software User's Manual</i> (Cat. No. W501).
NJ-series Instructions Reference Manual	W502	NJ501-□□□□ NJ301-□□□□	Learning detailed specifications on the basic instructions of an NJ-series CPU Unit.	The instructions in the instruction set (IEC 61131-3 specifications) are described. When programming, use this manual together with the <i>NJ-series CPU Unit Hardware User's Manual</i> (Cat. No. W500) and <i>NJ-series CPU Unit Software User's Manual</i> (Cat. No. W501).
NJ-series Motion Control Instructions Reference Manual	W508	NJ501-□□□□ NJ301-□□□□	Learning about the specifications of the motion control instructions that are provided by OMRON.	The motion control instructions are described. When programming, use this manual together with the <i>NJ-series CPU Unit Hardware User's Manual</i> (Cat. No. W500), <i>NJ-series CPU Unit Software User's Manual</i> (Cat. No. W501) and <i>NJ-series CPU Unit Motion Control User's Manual</i> (Cat. No. W507).
CJ-series Special Unit Manuals for NJ-series CPU Unit	W490 W498 W499 W491 Z317 W492 W494 W497 W495	CJ1W-□□□□	Learning how to use CJ-series Units with an NJ-series CPU Unit.	The methods and precautions for using CJ-series Units with an NJ501 CPU Unit are described, including access methods and programming interfaces. Manuals are available for the following Units. <ul style="list-style-type: none"> Analog I/O Units, Insulated-type Analog I/O Units, Temperature Control Units, ID Sensor Units, High-speed Counter Units, Serial Communications Units, DeviceNet Units, and EtherNet/IP Units. Use these manuals together with the <i>NJ-series CPU Unit Hardware User's Manual</i> (Cat. No. W500) and <i>NJ-series CPU Unit Software User's Manual</i> (Cat. No. W501).

Manual name	Cat. No.	Model numbers	Application	Description
NJ-series CPU Unit Built-in EtherCAT Port User's Manual	W505	NJ501-□□□□ NJ301-□□□□	Using the built-in EtherCAT port on an NJ-series CPU Unit.	Information on the built-in EtherCAT port is provided. This manual provides an introduction and provides information on the configuration, features, and setup. Use this manual together with the <i>NJ-series CPU Unit Hardware User's Manual</i> (Cat. No. W500) and <i>NJ-series CPU Unit Software User's Manual</i> (Cat. No. W501).
NJ-series CPU Unit Built-in EtherNet/IP Port User's Manual	W506	NJ501-□□□□ NJ301-□□□□	Using the built-in EtherNet/IP port on an NJ-series CPU Unit.	Information on the built-in EtherNet/IP port is provided. Information is provided on the basic setup, tag data links, and other features. Use this manual together with the <i>NJ-series CPU Unit Hardware User's Manual</i> (Cat. No. W500) and <i>NJ-series CPU Unit Software User's Manual</i> (Cat. No. W501).
NJ-series Troubleshooting Manual	W503	NJ501-□□□□ NJ301-□□□□	Learning about the errors that may be detected in an NJ-series Controller.	Concepts on managing errors that may be detected in an NJ-series Controller and information on individual errors are described. Use this manual together with the <i>NJ-series CPU Unit Hardware User's Manual</i> (Cat. No. W500) and <i>NJ-series CPU Unit Software User's Manual</i> (Cat. No. W501).
Sysmac Studio Version 1 Operation Manual	W504	SYSMAC-SE2□□□	Learning about the operating procedures and functions of the Sysmac Studio.	Describes the operating procedures of the Sysmac Studio.
CX-Integrator CS/CJ/CP/NSJ-series Network Configuration Tool Operation Manual	W464		Learning how to configure networks (data links, routing tables, Communications Unit settings, etc.).	Describes operating procedures for the CX-Integrator.
CX-Designer User's Manual	V099		Learning to create screen data for NS-series Programmable Terminals.	Describes operating procedures for the CX-Designer.
CX-Protocol Operation Manual	W344		Creating data transfer protocols for general-purpose devices connected to CJ-series Serial Communications Units.	Describes operating procedures for the CX-Protocol.
GX-series EtherCAT Slave Unit User's Manual	W488	GX-ID□□□□ GX-OD□□□□ GX-OC□□□□ GX-MD□□□□ GX-AD□□□□ GX-DA□□□□ GX-EC□□□□ XWT-ID□□ XWT-OD□□	Learning how to connect GX-series EtherCAT Slave Units.	Provides the specifications of and describes application methods for GX-series EtherCAT Slave Units.
MX2 Series Inverter EtherCAT Communication Unit User's Manual	I574	3G3AX-MX2-ECT	Learning how to connect a 3G3AX-MX2-ECT EtherCAT Communications Unit for MX2-series Inverters.	Describes the following information for the 3G3AX-MX2-ECT EtherCAT Communications Unit for an MX2-series Inverters: installation, parameter settings required for operation, troubleshooting, and inspection methods.
G5-series AC Servomotors/Servo Drives with Built-in EtherCAT Communications User's Manual	I576	R88D-KN□-ECT R88M-K□	Learning how to connect G5-series AC Servomotors/Servo Drives with EtherCAT Communications.	Describes the following information for the G5-series AC Servomotors/Servo Drives with EtherCAT Communications: installation, wiring methods, parameter settings required for operation, troubleshooting, and inspection methods.
FQ-M-series Specialized Vision Sensor for Positioning User's Manual	Z314	FQ-MS12□	Learning how to connect FQ-M-series Specialized Vision Sensor for Positioning.	Describes the following information for the FQ-M-series Specialized Vision Sensor for Positioning: installation, wiring methods, parameter settings required for operation, troubleshooting, and inspection methods.
EtherCAT Digital-type Sensor Communication Unit Operation Manual	E413	E3X-ECT	Learning how to connect E3X-series EtherCAT Slave Units.	Provides the specifications of and describes application methods for E3X-series EtherCAT Slave Units.

Revision History

A manual revision code appears as a suffix to the catalog number on the front and back covers of the manual.

Cat. No. W503-E1-02

↑
Revision code

Revision code	Date	Revised content
01	July 2011	Original production
02	January 2012	Added information related to the upgrade to unit version 1.01, made additions and changes to events related to the addition of devices that can be connected, and corrected mistakes.

1

Overview of Errors

This section provides information that is required to troubleshoot errors. It introduces the types of errors that can occur on an NJ-series Controller, the operation that occurs in response to errors, and the methods you can use to check for errors. Refer to *Section 2 Error Troubleshooting Methods* for information on troubleshooting errors.

1-1 Overview of NJ-series Errors	1-2
1-1-1 Types of Errors	1-2
1-1-2 CPU Unit Status	1-3
1-2 Fatal Errors	1-4
1-2-1 Types of Fatal Errors	1-4
1-2-2 Checking for Fatal Errors	1-4
1-3 Non-fatal Errors	1-5
1-3-1 Types of Non-fatal Errors	1-5
1-3-2 Checking for Non-fatal Errors	1-11
1-3-3 Resetting Non-fatal Errors	1-13

1-1 Overview of NJ-series Errors

You manage all of the errors that occur on the NJ-series Controller as events. The same methods are used for all events. This allows you to see what errors have occurred and find corrections for them with the same methods for the entire range of errors that is managed (i.e., CPU Unit, EtherCAT slaves,* and CJ-series Units).

* Only Sysmac devices are supported. For information on EtherCAT slaves that are Sysmac devices, refer to the *NJ-series CPU Unit Built-in EtherCAT Port User's Manual* (Cat. No. W505).

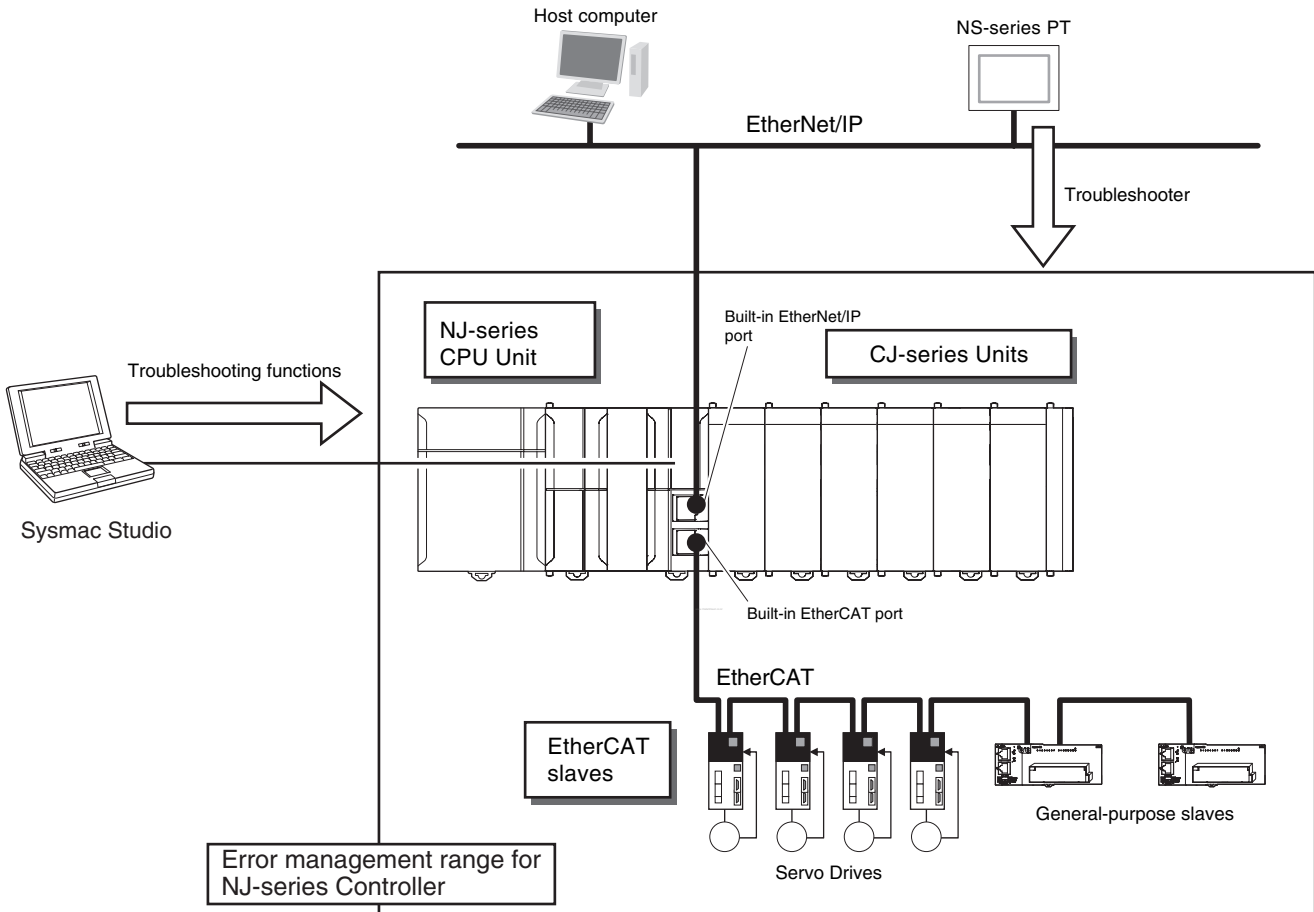

You can use the troubleshooting functions of the Sysmac Studio or the Troubleshooter on an NS-series PT to quickly check for errors that have occurred and find corrections for them.

To perform troubleshooting from an NS-series PT, connect the PT to the built-in EtherNet/IP port on the CPU Unit.

1-1-1 Types of Errors

There are two main types of errors (events) depending on whether the NJ-series Controller can manage them or not.

● Fatal Errors

These errors are not detected by the event management function of the NJ-series Controller because the CPU Unit stops operation. You cannot identify or reset these errors with the Sysmac Studio or an NS-series PT.

Refer to *1-2 Fatal Errors* for error types and confirmation methods for fatal errors.

● **Non-fatal Errors**

These errors are detected and managed with the event management function of the NJ-series Controller. You can confirm these errors with the Sysmac Studio or an NS-series PT.

Refer to *1-3 Non-fatal Errors* for error types and confirmation methods for non-fatal errors.

1-1-2 CPU Unit Status

You can check the operating status of the CPU Unit with the PWR, RUN, and ERROR indicators on the front panels of the Power Supply Unit and CPU Unit.

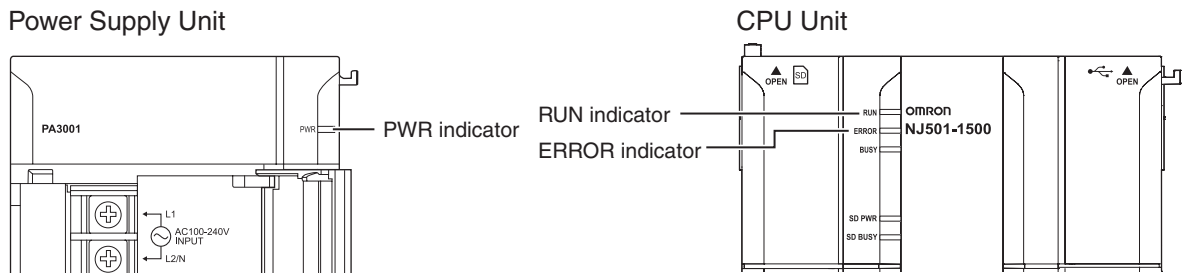

The following table shows the status of the front-panel indicators, the status of user program execution, and the ability to make a software connection to the Sysmac Studio or an NS-series PT during startup, during normal operation, and when there are errors in the Controller.

CPU Unit operating status		Power Supply Unit	CPU Unit		User program execution status	Software connection to Sysmac Studio or NS-series PT
		PWR (green)	RUN (green)	ERROR (red)		
During startup		Lit	Flashing (1-s intervals).	Not lit	Stops.	Not possible.
During normal operation	RUN mode	Lit	Lit	Not lit	Continues.	Possible.
	PROGRAM mode	Lit	Not lit	Not lit	Stops.	
Fatal errors	Power Supply Error*1	Not lit	Not lit	Not lit	Stops.	Not possible.
	CPU Unit Reset*1	Lit	Not lit	Not lit	Stops.	
	Incorrect Power Supply Unit Connected*1	Lit	Flashing (3-s intervals).	Lit	Stops.	
	CPU Unit Watchdog Timer Error*1	Lit	Not lit	Lit	Stops.	
Non-fatal errors	Major fault*2	Lit	Not lit	Lit	Stops.	Possible. (Communications can be connected from an NS-series PT if Ether-Net/IP is operating normally.)
	Partial fault*2	Lit	Lit	Flashing (1-s intervals).	Continues.*3	
	Minor fault*2	Lit	Lit	Flashing (1-s intervals).	Continues.	
	Observation*2	Lit	Lit	Not lit	Continues.	

*1 Refer to *1-2 Fatal Errors* for information on individual errors.

*2 Refer to *1-3 Non-fatal Errors* for information on individual errors.

*3 The function module where the error occurred stops.

1-2 Fatal Errors

1-2-1 Types of Fatal Errors

This section describes the errors that cause the operation of the NJ-series CPU Unit to stop. Software connections to the Sysmac Studio or an NS-series PT cannot be made if there is a fatal error in the Controller.

● Power Supply Error

Power is not supplied, the voltage is outside of the allowed range, or the Power Supply Unit is faulty.

● CPU Unit Reset

The CPU Unit stopped operation because of a hardware error. Other than hardware failures, this error also occurs at the following times.

- The power supply to an Expansion Rack is OFF.
- The I/O Connecting Cable is incorrectly installed.
 - The IN and OUT connectors are reversed.
 - The connectors are not mated properly.
- There is more than one I/O Control Unit on the CPU Rack or there is an I/O Control Unit on an Expansion Rack.

● Incorrect Power Supply Unit Connected

There is a CJ-series Power Supply Unit connected to the CPU Rack. The operation of the Controller is stopped.

● CPU Unit Watchdog Timer Error

This error occurs in the CPU Unit. This error occurs when the watchdog timer times out because a hardware failure or when temporary data corruption causes the CPU Unit to hang.

1-2-2 Checking for Fatal Errors

You can identify fatal errors based on the status of the PWR indicator on the Power Supply Unit and the RUN and ERROR indicators on the CPU Unit, as well as by the ability to go online with the CPU Unit from the Sysmac Studio. Refer to *Section 2 Error Troubleshooting Methods* for information on identifying errors and corrections.

Indicators			Going online from the Sysmac Studio	CPU Unit operating status
PWR (green)	RUN (green)	ERROR (red)		
Not lit	Not lit	Not lit	Not possible.*	Power Supply Error
Lit	Not lit	Not lit		CPU Unit Reset
Lit	Flashing (3-s intervals).	Lit		Incorrect Power Supply Unit Connected
Lit	Not lit	Lit		CPU Unit Watchdog Timer Error

* Power Supply Errors and Incorrect Power Supply Unit Connected errors can be differentiated with the indicators. There is no need to see if you can go online with the CPU Unit from the Sysmac Studio.

1-3 Non-fatal Errors

Non-fatal errors that occur are managed as events in the NJ-series Controller. You can check the event to find out what type of error occurred.

1-3-1 Types of Non-fatal Errors

Overview of Controller Events (Errors and Information)

You use the same methods to manage all of the events that occur on the NJ-series Controller. The events that occur are saved in battery-backup memory in the CPU Unit. You can use the Sysmac Studio or an NS-series PT to confirm current Controller events and the log of events that occurred before. This log is called an event log.

To use an NS-series PT to check events, connect the PT to the built-in EtherNet/IP port on the CPU Unit.

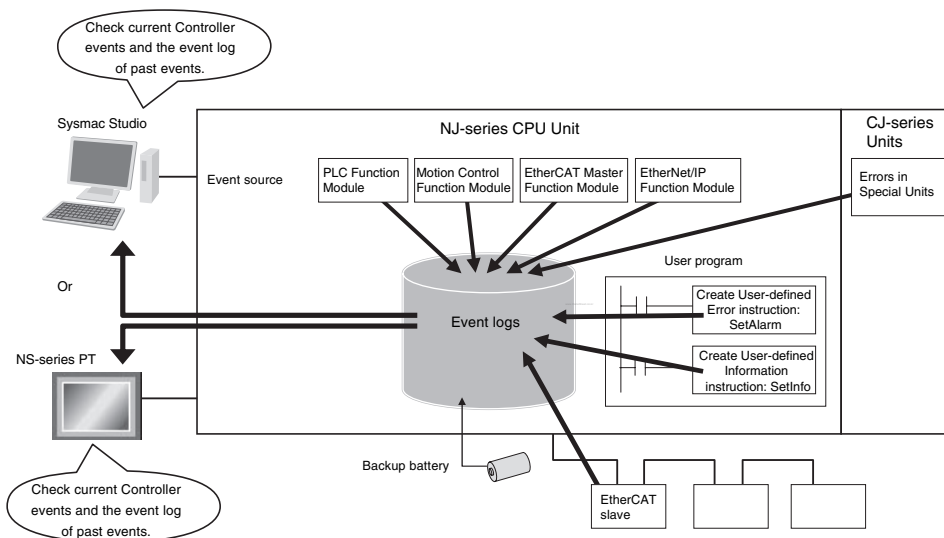

The following events can occur.

● Controller Events

The Controller automatically detects these events. Controller events include events for the function modules in the CPU Unit, EtherCAT slaves, and CJ-series Units.

The error logs from within the EtherCAT slaves and the CJ-series Special Units are not included. Refer to the manuals for the slaves or Special Units for the procedures to read their error logs.

● User-defined Events

These are events that occur in applications that the user developed.

Refer to the *NJ-series CPU Unit Software User's Manual* (Cat. No. W501) for information on user-defined events.

Non-fatal errors are managed as Controller events. This section describes mainly the Controller events.

Details on Controller Events (Errors and Information)

● Sources of Controller Events

The *Event* source information indicates the location where an event occurred. The event source identifies the particular function module in the CPU Unit in which the event occurred. For some function modules, there is more detailed information about the event source. This information is called the *Source details*. The following information is provided as the event source details.

Event source	Source details
PLC Function Module	I/O bus master or CJ-series Unit
Motion Control Function Module	Common, axis, or axes group
EtherCAT Master Function Module	Communications port, EtherCAT master, or EtherCAT slave
EtherNet/IP Function Module	Communications port, CIP, FTP, NTP, or SNMP

The event source is displayed on the Sysmac Studio or NS-series PT.

● Levels of Controller Events (Errors and Information)

The following table classifies the levels of Controller events according to the effect that the errors have on control.

No.	Level	Classification	Level name
1	High	Controller errors	Major fault level
2	↑		Partial fault level
3			Minor fault level
4	↓		Observation
5	Low	Controller information	Information

Errors with a higher level have a greater impact on the functions that the NJ-series Controller provides, and are more difficult to recover from. When an event occurs, the Sysmac Studio or PT will display the level.

Event Levels

- **Major Fault Level**
These errors prevent control operations for the entire Controller. When the CPU Unit detects a major fault, it immediately stops the execution of the user program and turns OFF the loads of all slave, including remote I/O. With EtherCAT slaves and some CJ-series Special Units, you can set the slave settings or Unit settings to select whether outputs will go OFF or retain their previous status. You cannot reset major fault level errors from the user program, the Sysmac Studio or an NS-series PT. To recover from a major fault level error, remove the cause of the error, and either cycle the power supply to the Controller, or reset the Controller from the Sysmac Studio.
- **Partial Fault Level**
These errors prevent control operations in a certain function module in the Controller. The NJ-series CPU Unit continues to execute the user program even after a partial fault level error occurs. You can include error processing in the user program in order to stop equipment safely. After you remove the cause of the error, execute one of the following to return to normal status.
 - Reset the error from the user program, the Sysmac Studio, or an NS-series PT.
 - Cycle the power supply.
 - Reset the Controller from the Sysmac Studio.
- **Minor Fault Level**
These errors prevent part of the control operations in a certain function module in the Controller. The troubleshooting for minor fault level errors is the same as the processing for partial fault level errors.
- **Observations**
These errors do not affect the control operations of the Controller. The observation notifies you of potential problems before they develop into a minor fault level error or worse.

- Information
Events that are classified as information provide information that do not indicate errors.

Operation for Each Level

The way that the Controller operates when an event occurs depends on the level of the Controller event.

Event level		Controller errors				Controller information
		Major fault level	Partial fault level	Minor fault level	Observation	Information
Definition		These errors are serious errors that prevent control operations for the entire Controller.	These errors prevent all of the control in a function module other than PLC Function Module.	These errors prevent part of the control operations in a certain function module.	These errors do not affect system control operations.	These are not errors, but appear in the event log to notify the user of specific information.
Event examples (Only a few examples are provided here. Refer to Section 3 Error Tables for a list of all of the errors.)		<ul style="list-style-type: none"> • I/O Bus Check Error (PLC Function Module) 	<ul style="list-style-type: none"> • Motion Control Period Exceeded (Motion Control Function Module) • Communications Controller Failure (EtherCAT Master Function Module) 	<ul style="list-style-type: none"> • Positive Limit Input Detected (Motion Control Function Module) • Analog Input Disconnection Detected (CJ-series Unit) • Low Battery Voltage (PLC Function Module) 	<ul style="list-style-type: none"> • Packet Discarded Due to Full Reception Buffer (Ethernet/IP Function Module) 	<ul style="list-style-type: none"> • Power Turned ON • Power Interrupted • Memory All Cleared
Front-panel indicators *1	PWR (green)	Lit	Lit	Lit	Lit	Lit
	RUN (green)	Not lit	Lit	Lit	Lit	Lit
	ERROR (red)	Lit	Flashes at 1-s intervals.	Flashes at 1-s intervals.	Not lit	Not lit
NJ-series CPU Unit operation	RUN output on Power Supply Unit	OFF	ON	ON	ON	ON
	User program execution status	Stops.	Continues.*2	Continues.	Continues.	Continues.
	Outputs turned OFF	Yes	No	No	No	No
	Error reset	Not possible.	Depends on the nature of the error.	Depends on the nature of the error.	---	---
	Event logs	Recorded. (Some errors are not recorded.)	Recorded.	Recorded.	Recorded.	Recorded.

Event level Item	Controller errors				Controller information
	Major fault level	Partial fault level	Minor fault level	Observation	Information
Outputs from EtherCAT slaves and Basic Output Units	Refer to <i>I/O Operation for Major Fault Level Controller Errors</i> on page 1-9.	<ul style="list-style-type: none"> Errors in EtherCAT Master Function Module: Depends on settings in the slave. Errors in other function modules: According to user program. 	According to user program.	According to user program.	According to user program.
Sysmac Studio display (when online)	Error messages are automatically displayed in the Controller Status Pane. The user can display detailed information in the Troubleshooting Dialog Box.			These errors and events are not shown on the display of Controller errors.	

*1 If multiple Controller errors have occurred, the indicators show the error with the highest event level.

*2 Operation stops in the function module (Motion Control Function Module, EtherCAT Master Function Module, or EtherNet/IP Function Module) in which the error occurred.

Operation in the Function Module Where an Error Event Occurred

Event level	Major fault level	Partial fault level	Minor fault level	Observation
Function module				
PLC Function Module	Operation stops.	---	Operation continues.	
Motion Control Function Module	Operation stops.	All axes stop. (The stop method depends on the error.)	<ul style="list-style-type: none"> The affected axes/axes group stops. (The stop method depends on the settings.) The motion control instruction is not executed (for instructions related to axis operation.) 	<ul style="list-style-type: none"> Axis operation continues. The motion control instruction is not executed (for instructions not related to axis operation).
EtherCAT Master Function Module	Operation stops.	EtherCAT communications stop.	EtherCAT communications stop or continue according to the setting of the fail-soft operation in the master.	EtherCAT communications continue.
EtherNet/IP Function Module	Operation stops.	EtherNet/IP communications stop. (A software connection from the Sysmac Studio or an NS-series PT is not possible.)	Part of the EtherNet/IP communications stop. (A software connection from the Sysmac Studio or an NS-series PT is possible if the communications connection is not the cause of the error.)	EtherNet/IP communications continue.

I/O Operation for Major Fault Level Controller Errors

- The following table gives the operation for the following errors.
 - Unsupported Unit Detected
 - I/O Bus Check Error
 - End Cover Missing
 - Incorrect Unit/Expansion Rack Connection
 - Duplicate Unit Number
 - Too Many I/O Points
 - I/O Setting Check Error

Unit	CPU Unit operation	Unit or slave operation
EtherCAT slaves	The slave operates in Safe-Operational state.	Depends on the slave settings.*
CJ-series Basic I/O Units	Refreshing stops.	<ul style="list-style-type: none"> All outputs are turned OFF. All inputs are turned OFF.
CJ-series Special Units	Refreshing stops.	Depends on the Unit operating specifications. (ERH indicator lit.)
Servo Drives	Stops updating the command values.	All axes stop immediately.

* Settings and setting methods depend on the slave. Refer to the manual for the slave. For a Servo Drive, operation depends on the setting of object 605E hex (Fault Reaction Option Code).

- The following table gives the operation for all other errors.

Unit	CPU Unit operation	Unit or slave operation
EtherCAT slaves	The slave operates in Safe-Operational state.	Depends on the slave settings.*
CJ-series Basic I/O Units	<ul style="list-style-type: none"> All outputs are turned OFF. Input refreshing continues. 	<ul style="list-style-type: none"> All outputs are turned OFF. External inputs are refreshed.
CJ-series Special Units	Refreshing continues.	Depends on the Unit operating specifications.
Servo Drives	Stops updating the command values.	All axes stop immediately.

* Settings and setting methods depend on the slave. Refer to the manual for the slave. For a Servo Drive, operation depends on the setting of object 605E hex (Fault Reaction Option Code).

● Event Code

Events that occur in a Controller have an event code. When an event occurs, the Sysmac Studio or PT will display the event code. You can use the instructions that get error status to read the error codes of current errors from the user program.

The event codes are 8-digit hexadecimal values. The first digit of a Controller event represents its category. These categories are listed in the table below.

First digit of the code (hex)	Classification	Meaning
0	Hardware errors	An error caused by a hardware problem such as an internal part malfunction, contact failure, temperature error, undervoltage, overvoltage, or overcurrent.
1	Data errors	An error caused by incorrectly saved data or data corruption in the Controller.
2	Hardware setting errors	An error caused by incorrect handling of hardware settings (e.g., hardware switches) or restrictions (e.g., Unit assignment locations).
3	Configuration errors	An error caused by incorrect parameter values, parameters and hardware configurations that do not match, or configurations set by the user.
4	Software errors	An error caused by Controller software.
5	User software errors	An error that is caused by the user program. (For example, an input value to an instruction that is out of range.)
6	Observation errors	An error that was detected in monitoring operation that occurs due to user settings in the Controller. (For example, if the task period is exceeded or if a position outside of the motion range is detected.)
7	Control errors	An error caused by a control process. (For example, if the operating status does not meet the required conditions or if the timing is incorrect.)
8	Communications errors	An error caused by communications with an external device or host system.
9	Information	Events that are classified as information and provide information that do not indicate errors.

Some of the function modules output part of the event code as an error code when an error occurs. You can check the error codes for the following function modules.

- Motion Control Function Module

You can check error codes with the following variables.

- ErrorID* output variable for motion control instructions
- The following system-defined variables for motion control:

Variable name	Meaning
_MC_COM.PFaultLvl.Code	MC Common Partial Fault Code
_MC_COM.MFaultLvl.Code	MC Common Minor Fault Code
_MC_COM.Obsr.Code	MC Common Observation Code
_MC_AX[0..63].MFaultLvl.Code	Axis Minor Fault Code
_MC_AX[0..63].Obsr.Code	Axis Observation Code
_MC_GRP[0..31].MFaultLvl.Code	Axes Group Minor Fault Code
_MC_GRP[0..31].Obsr.Code	Axes Group Observation Code

The upper four digits of the event code is output as the error code. Check the error list by using the error code as the upper four digits and 0000 hex as the lower four digits of the event code. Refer to the *NJ-series CPU Unit Motion Control User's Manual* (Cat. No. W507) and *NJ-series Motion Control Instructions Reference Manual* (Cat. No. W508) for lists of errors.

● Exporting the Error Log

You can use the Sysmac Studio or an NS-series PT to export the displayed event log to a CSV file. Refer to the *NJ-series CPU Unit Software User's Manual* (Cat. No. W501) for information on exporting event logs

1-3-2 Checking for Non-fatal Errors

Checking Methods

Use the following methods to check for non-fatal errors.

Checking method	What you can check
Checking the indicators	You can use the indicators to confirm the Controller error level, the error status of the EtherCAT Master Function Module, and the error status of the EtherNet/IP Function Module.
Checking with the Troubleshooting Function of Sysmac Studio	You can check for current Controller errors, a log of past Controller errors, error sources, error causes, and corrections.
Checking with the Troubleshooter of an NS-series PT*	You can check for current Controller errors, a log of past Controller errors, error sources, error causes, and corrections.
Instructions that read function module error status	You can check the highest-level status and highest-level event code in the current Controller errors.
Checking with system-defined variables	You can check the current Controller error status for each function module.

* To perform troubleshooting from an NS-series PT, connect the PT to the built-in EtherNet/IP port on the CPU Unit.

This section describes the above checking methods.

Checking the Indicators

● Checking the Level of a Controller Error

You can use the PWR indicator on the Power Supply Unit and the RUN and ERROR indicators on the CPU Unit to determine the level of an error. The following table shows the relationship between the Controller's indicators and the event level.

Indicators			Event level
PWR (green)	RUN (green)	ERROR (red)	
Lit	Not lit	Lit	Major fault level
Lit	Lit	Flashing (1-s intervals).	Partial fault level
			Minor fault level

Indicators			Event level
PWR (green)	RUN (green)	ERROR (red)	
Lit	Lit	Not lit	Observation

● **Checking Errors in the EtherCAT Master Function Module and EtherNet/IP Function Module**

For the EtherCAT Master Function Module and EtherNet/IP Function Module, use the EtherCAT and EtherNet/IP NET ERR indicators to determine whether a minor fault level error or higher-level error has occurred. The indicators let you check the status given in the following table.

Indicators	Indicated status
EtherCAT NET ERR	EtherCAT Master Function Module Status <ul style="list-style-type: none"> • Lit: Errors for which normal status cannot be recovered through user actions (i.e., errors for which you must replace the CPU Unit or contact your OMRON representative). • Flashing: Errors for which normal status can be recovered through user actions. • No lit: There are no minor fault level or higher-level errors.
EtherNet/IP NET ERR	EtherNet/IP Function Module Status <ul style="list-style-type: none"> • Lit: Errors for which normal status cannot be recovered through user actions (i.e., errors for which you must replace the CPU Unit or contact your OMRON representative). • Flashing: Errors for which normal status can be recovered through user actions. • No lit: There are no minor fault level or higher-level errors.

Checking with the Troubleshooting Function of Sysmac Studio

When an error occurs, you can connect the Sysmac Studio online to the Controller to check current Controller errors and the log of past Controller errors.

● **Current Errors**

Open the Sysmac Studio's Controller Error Tab Page to check the current error's level, source, source details, event name, event code, details, attached information 1 to 4, actions, and corrections. Errors are not displayed for observations.

● **Log of Past Errors**

Open the Sysmac Studio's Controller Event Log Tab Page to check the times, levels, sources, source details, event names, event codes, details, attached information 1 to 4, actions, and corrections for previous errors.

Refer to the *NJ-Series Sysmac Studio Version 1 Operation Manual* (Cat. No. W504) for details on troubleshooting with the Sysmac Studio.

Checking with the Troubleshooter of an NS-series PT

When an error occurs, if you can connect communications between an NS-series PT and the Controller, you can check current Controller errors and the log of past Controller errors.

To perform troubleshooting from an NS-series PT, connect the PT to the built-in EtherNet/IP port on the CPU Unit.

● **Current Errors**

Open the Controller Error Tab Page on the NS-series PT's Troubleshooter to check the current error's event name, event code, level, source, source details, time, details, and attached information 1 to 4. Observations are not displayed on this tab page.

● Log of Past Errors

Open the Controller Event Log Tab Page on the NS-series PT's Troubleshooter to check the time, level, source, event name, event code, details, and attached information 1 to 4 for previous errors.

Refer to the *NS-series Programmable Terminals Programming Manual* (Cat. No. V073) for details on the NS-series PT's Troubleshooter.

Instructions That Read Function Module Error Status

You can determine the error status with the instructions that get error status provided for each function module from the user program. These instructions get the status and the event code of the error with the highest level.

Applicable function module	Instruction name	Instruction
PLC Function Module	Get PLC Controller Error Status	GetPLCError
	Get I/O Bus Error Status	GetCJBError
Motion Control Function Module	Get Motion Control Error Status	GetMCError
EtherCAT Master Function Module	Get EtherCAT Error Status	GetECError
EtherNet/IP Function Module	Get EtherNet/IP Error Status	GetEIPError

For details on the instructions that get error status, refer to the *NJ-series Instructions Reference Manual* (Cat. No. W502).

Checking with System-defined Variables

You can check the Error Status variable in the system-defined variables to determine the status of errors in a Controller. You can read the Error Status variable from an external device by using communications. Refer to the *NJ-series CPU Unit Software User's Manual* (Cat. No. W501) for information on system-defined variables.

1-3-3 Resetting Non-fatal Errors

Unless you reset an error, the CPU Unit will retain the error status until you turn OFF the power supply to the Controller or reset the Controller.

To reset a Controller error, it is necessary to eliminate the cause of the error. The same error will occur again if you reset the error, but do not eliminate the cause of the error.



Precautions for Safe Use

Always confirm safety at the connected equipment before you reset Controller errors with an event level of partial fault or higher for the EtherCAT Master Function Module. When the error is reset, all slaves that were in any state other than Operational state (in which outputs are disabled) due to the Controller error with an event level of partial fault or higher will go to Operational state and the outputs will be enabled. Before you reset all errors, confirm that no Controller errors with an event level of partial fault have occurred for the EtherCAT Master Function Module.

Always confirm safety at the connected equipment before you reset Controller errors for a CJ-series Special Unit. When the Controller error is reset, the Unit where the Controller error with an event level of observation or higher will be restarted. Before you reset all errors, confirm that no Controller errors with an event level of observation or higher have occurred for the CJ-series Special Unit. Observation level events do not appear on the Controller Error Tab Page, so it is possible that you may restart the CJ-series Special Unit without intending to do so. You can check the status of the `_CJB_UnitErrSta[0,0]` to `_CJB_UnitErrSta[3,9]` Error Status variables on a Watch Tab Page to see if an observation level Controller error has occurred.

**Precautions for Correct Use**

Resetting an error is not the same as eliminating the cause of the error. Always eliminate the cause of an error before you perform the procedure to reset the error.

Error Resetting Methods

Method	Operation	Errors that are reset	Description
Commands from Sysmac Studio	Resetting Controller errors	Resetting all errors for all function modules	Reset the Controller errors from the Sysmac Studio's Troubleshooting Dialog Box.
	Downloading	Resetting all errors for a specific function module	After the causes of the Controller errors are removed, all Controller errors in the relevant function module are reset as a result. Errors are not reset when you download the Controller Configurations and Setup.
	Memory All Clear	Resetting all errors for all function modules	After the causes of the Controller errors are removed, all Controller errors in all function modules are reset as a result.
	Controller reset		After the causes of the Controller errors are removed, all Controller errors in all function modules are reset as a result.
Commands from an NS-series PT*	Resetting Controller errors		Reset Controller errors from the Troubleshooter of an NS-series PT that is compatible with NJ-series Controllers. You can reset errors from a PT that is not directly compatible with the NJ-series Controller or another company's HMI if you use the PT/HMI in combination with the reset error instruction for the function module in the user program.
Commands from the user program	Resetting Controller errors	Resetting errors for individual function modules	Execute the reset error instruction for the function module in the user program. <ul style="list-style-type: none"> For the Motion Control Function Module, you can reset all errors, errors for a particular axis, or errors for a particular axes group. For the I/O bus, you can reset all errors or just the errors for a particular Unit.
Commands from a host computer	Resetting Controller errors with CIP messages	Resetting all errors for all function modules	Use a CIP message from a host computer to reset errors.
Cycling the Controller's power supply	---	Resets all errors.	After the causes of the Controller errors are removed, all Controller errors in all function modules are reset as a result.

* To reset errors from an NS-series PT, connect the PT to the built-in EtherNet/IP port on the CPU Unit.

2

Error Troubleshooting Methods

This section describes troubleshooting methods for specific errors.

2-1	Troubleshooting Flowcharts	2-2
2-1-1	Checking to See If the CPU Unit Is Operating	2-2
2-1-2	Troubleshooting Flowchart for Non-fatal Errors	2-3
2-2	Troubleshooting Fatal Errors	2-4
2-3	Troubleshooting Non-fatal Errors	2-5
2-3-1	Identifying and Resetting Errors with the Sysmac Studio	2-5
2-3-2	Identifying and Resetting Errors with an NS-series PT	2-9
2-3-3	Identifying and Resetting Errors from the User Program	2-11
2-3-4	Checking for Errors with System-defined Variables	2-13
2-4	Troubleshooting When You Cannot Go Online from the Sysmac Studio	2-14
2-4-1	Causes and Correction When You Cannot Go Online from the Sysmac Studio	2-14
2-4-2	Troubleshooting for Each Cause	2-15

2-1 Troubleshooting Flowcharts

This section provides basic error identification and troubleshooting flowcharts. Use them when an error occurs in the NJ-series Controller.

2-1-1 Checking to See If the CPU Unit Is Operating

When an error occurs in the NJ-series Controller, use the following flowchart to determine whether the error is a fatal error or a non-fatal error.

Whenever possible, set the Sysmac Studio's software connection method in the flowchart to a direct USB connection. If you use Ethernet, there are many reasons that prevent a software connection from the Sysmac Studio, so time is required to determine if a fatal or non-fatal error has occurred. If you cannot go online from the Sysmac Studio, perform *2-4 Troubleshooting When You Cannot Go Online from the Sysmac Studio* before you assume that the error is a fatal error.

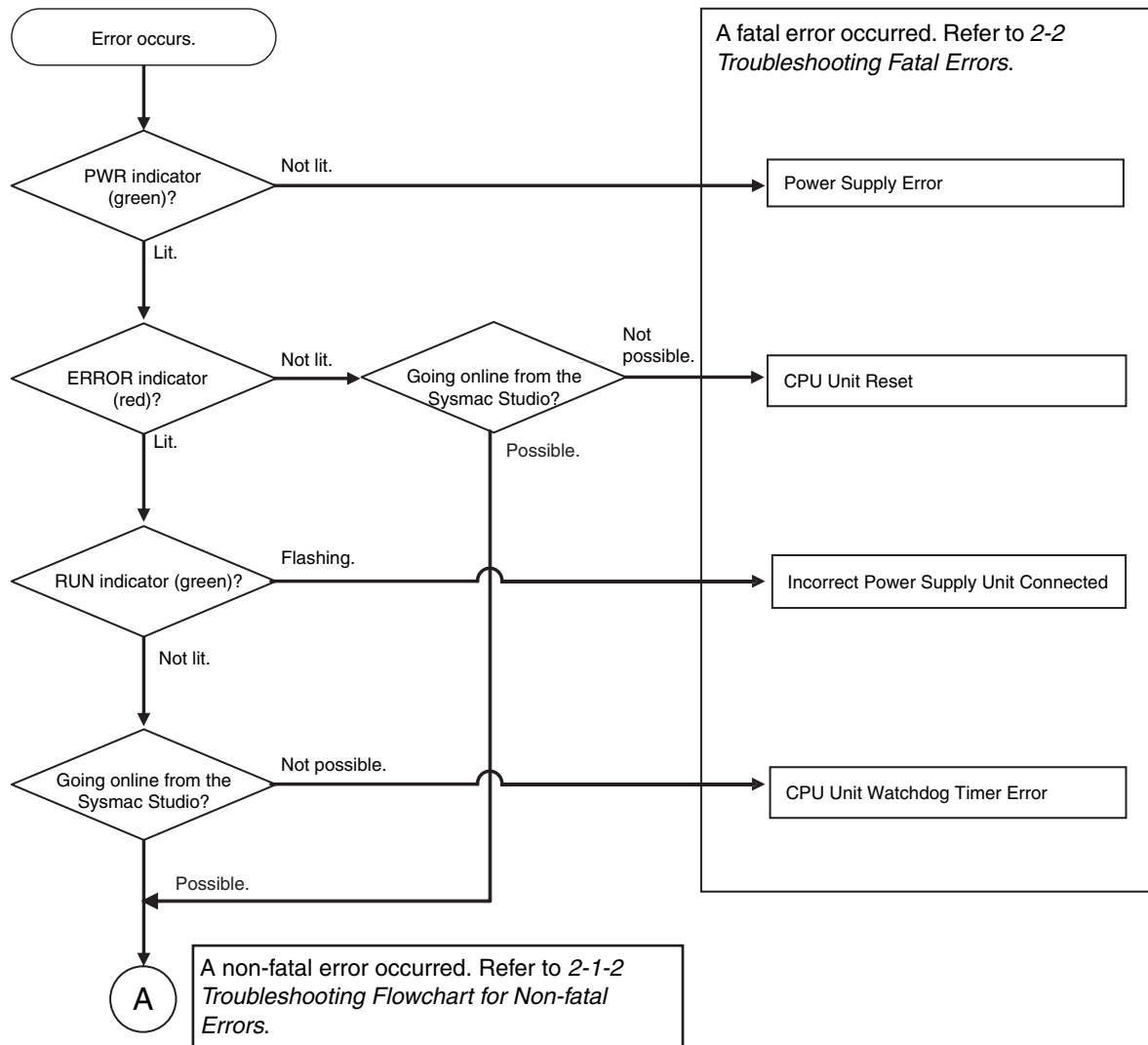

2-1-2 Troubleshooting Flowchart for Non-fatal Errors

For a non-fatal error, use the Sysmac Studio or an NS-series PT to troubleshoot the error with the following flowchart. You can use the indicators to check the following:

- Level
- Whether the error is in the EtherNet/IP Function Module or the EtherCAT Master Function Module
- If the sources of the error is the EtherNet/IP Function Module or the EtherCAT Master Function Module, whether you can restore normal status yourself

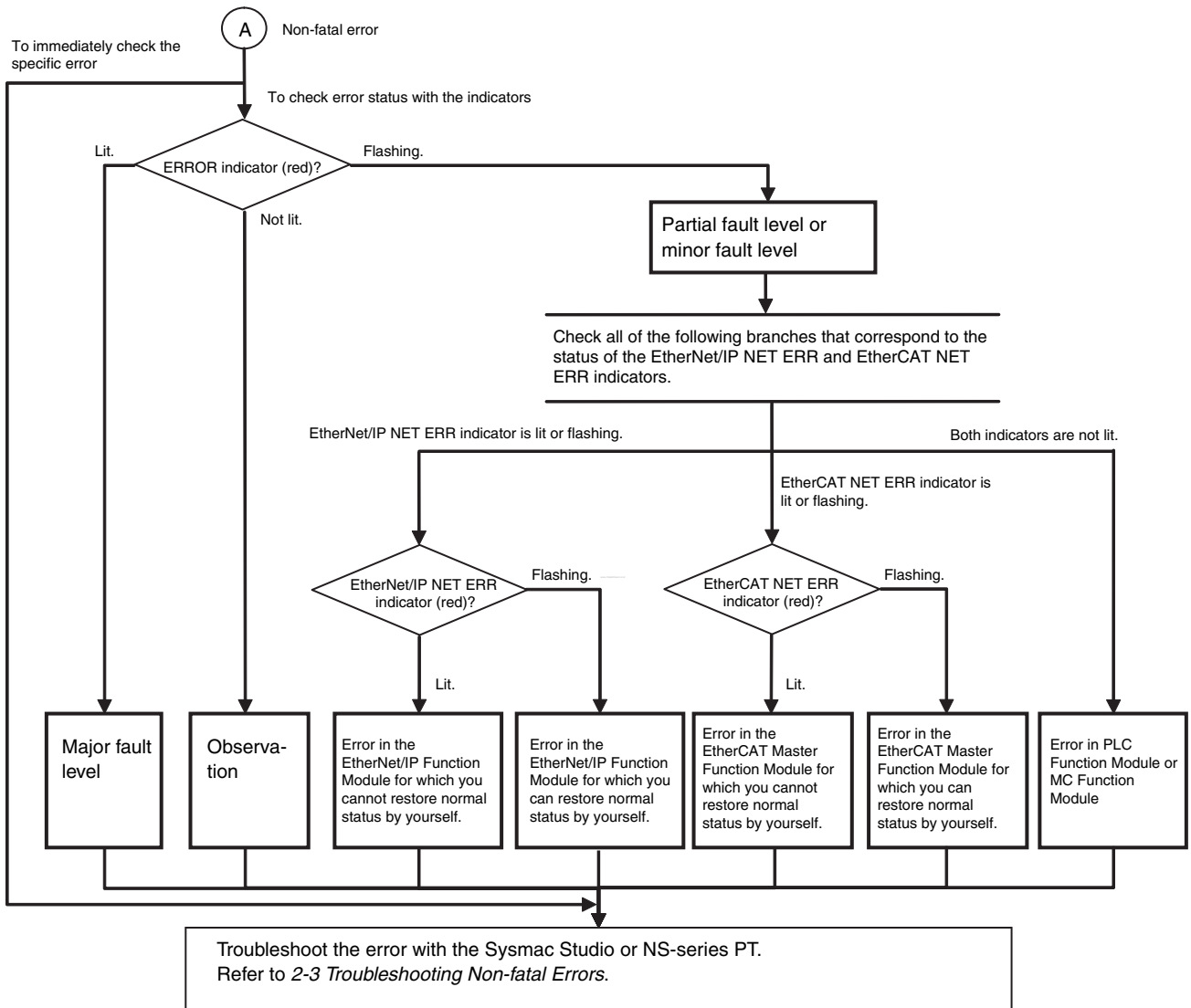

2-2 Troubleshooting Fatal Errors

The section describes the procedure to troubleshoot fatal errors.

● Power Supply Error

Cause	Correction
Power is not being input.	Turn ON the power.
The voltage is outside of the allowable range for the power supply.	Check the Controller's power supply system, and correct it so that the voltage is within the allowable range.
Power supply system error caused by mounted Unit	Remove the Units from the CPU Rack one by one. If the error is eliminated, replace that Unit.
Power Supply Unit failure	If the error persists even after you make the above corrections, replace the Power Supply Unit.

● CPU Unit Reset

Cause	Correction
A conductive object has gotten inside.	If there is conductive material nearby, blow out the CPU Unit with air.
The power supply to an Expansion Rack is OFF.	Supply the correct voltage to the Power Supply Unit on the Expansion Rack.
The I/O Connecting Cable is incorrectly installed.	Correct the connection of the I/O Connecting Cable.
Noise	If the error did not result from the above causes, cycle the power to the Controller and see if that resets the error. If the error occurs frequently, check the FG and power supply lines to see if noise is entering on them. Implement noise countermeasures as required.
CPU Unit failure	If the error persists even after you make the above corrections, replace the CPU Unit.

● Incorrect Power Supply Unit Connected

Cause	Correction
A CJ-series Power Supply Unit is connected to the CPU Rack.	Connect an NJ-series Power Supply Unit to the CPU Rack.

● CPU Unit Watchdog Timer Error

Cause	Correction
A conductive object has gotten inside.	If there is conductive material nearby, blow out the CPU Unit with air.
Noise	If the error did not result from the above causes, cycle the power to the Controller and see if that resets the error. If the error occurs frequently, check the FG and power supply lines to see if noise is entering on them. Implement noise countermeasures as required.
CPU Unit failure	If the error persists even after you make the above corrections, replace the CPU Unit.

2-3 Troubleshooting Non-fatal Errors

2-3-1 Identifying and Resetting Errors with the Sysmac Studio

Troubleshooting functions are provided by the Sysmac Studio. You can use the troubleshooting functions to identify errors that occur in a Controller, and reset the errors.

Displaying Errors on the Sysmac Studio

If an error occurs while the Sysmac Studio is online with the CPU Unit, the Sysmac Studio notifies the user of the error in the Controller Status Pane. From there, you can open the Troubleshooting and Event Log Window to read detailed error information and troubleshooting methods.

Click the **Troubleshooting** Button in the toolbar, or select **Troubleshooting** from the Tools Menu.

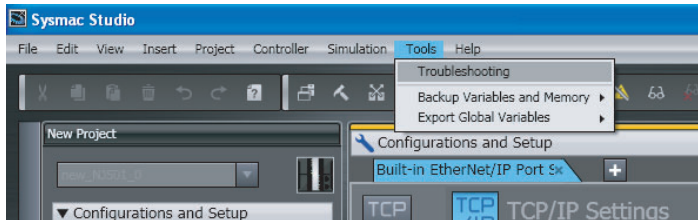

The Sysmac Studio automatically collects the Controller's error information, and opens the Troubleshooting Window.

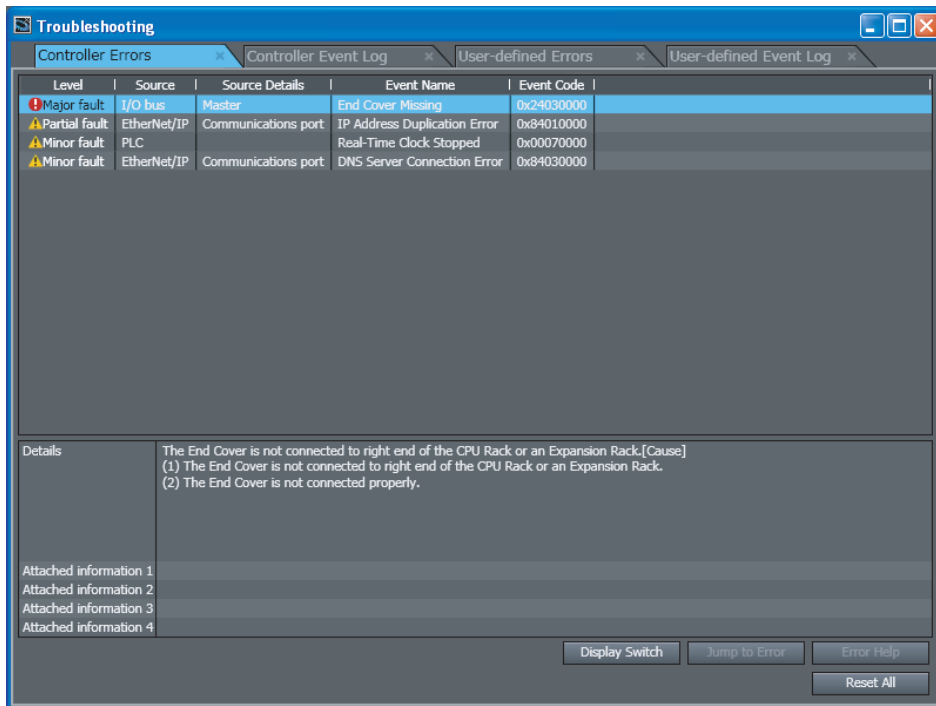

Checking Current Errors and the Event Logs with the Sysmac Studio

● Checking Current Errors with the Sysmac Studio

You can click the **Controller Errors** Tab in the Troubleshooting Window to read information on current errors in the Controller.

The Controller Errors Tab Page lists the current errors in order of their levels.

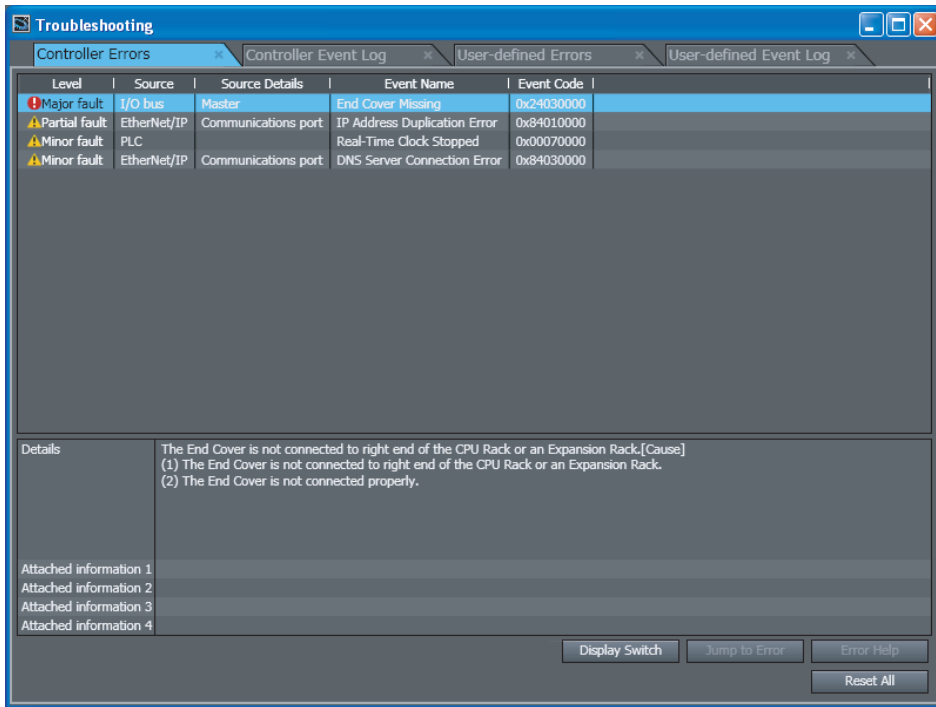

Display item	Description
Level	This is the event level of the error.
Source and Source Details	This is the physical location and functional location of the error.
Event Name	Error name
Event Code	This is the code of the error.

You can click the column headings in the Controller error list, such as the *Level* or *Source*, to reorder the table rows according to that heading. For example, the following change occurs when you click the *Source* heading.

Before *Source* heading is clicked.

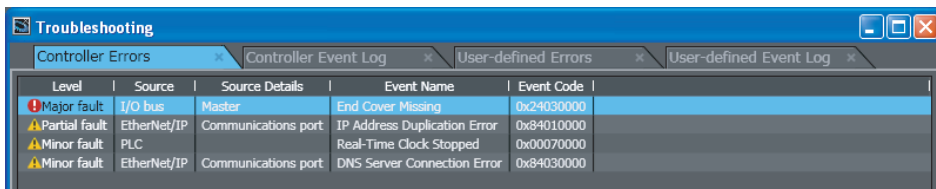

After *Source* heading is clicked.

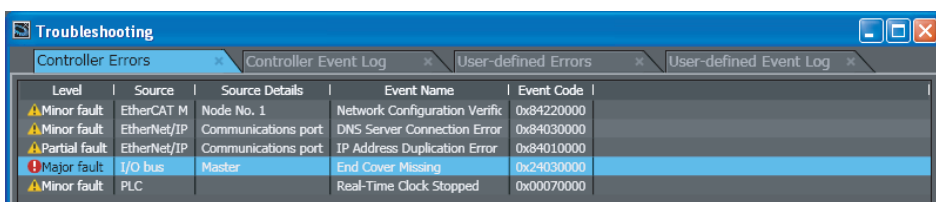

● Displaying Event Logs with the Sysmac Studio

With Sysmac Studio, you can check a log of the Controller events that previously occurred on the Controller Event Log Tab Page.

You can select the event logs and levels to display in the Display Settings Area. Information on the events that you specify are displayed in the detailed information area.

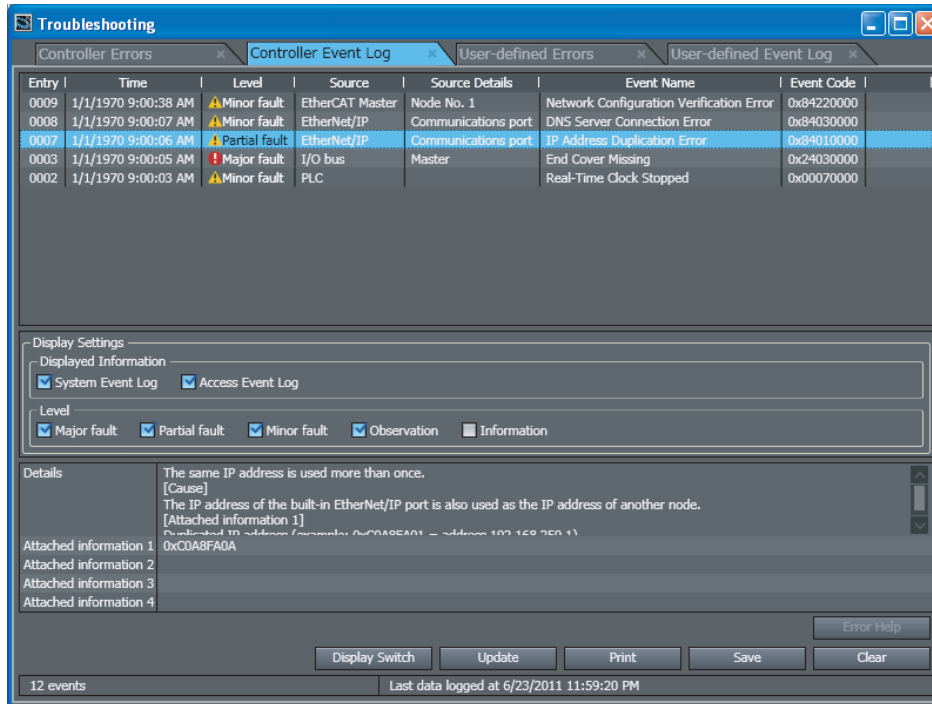

Resetting Errors with the Sysmac Studio

You can use the Sysmac Studio to reset errors that occur in a Controller. Before you attempt to reset a Controller error, isolate and remove the cause of the error.

The Troubleshooting Dialog Box displays the cause, source, and corrections for the error. You can select any of the items from the error list to display the following information about that error. Click the **Display Switch** Button to switch between displaying details and attached information and displaying actions and corrections.

Display item	Description
Details	Detailed information on the error is displayed, such as the probable causes.
Attached information 1 through 4	Detailed information about the source of the error is displayed.
Action and Correction	Methods to correct the probable causes of the error are displayed.

After confirming the cause of the displayed error and the conditions in which it occurred, perform the displayed error corrections to eliminate the cause of the error.

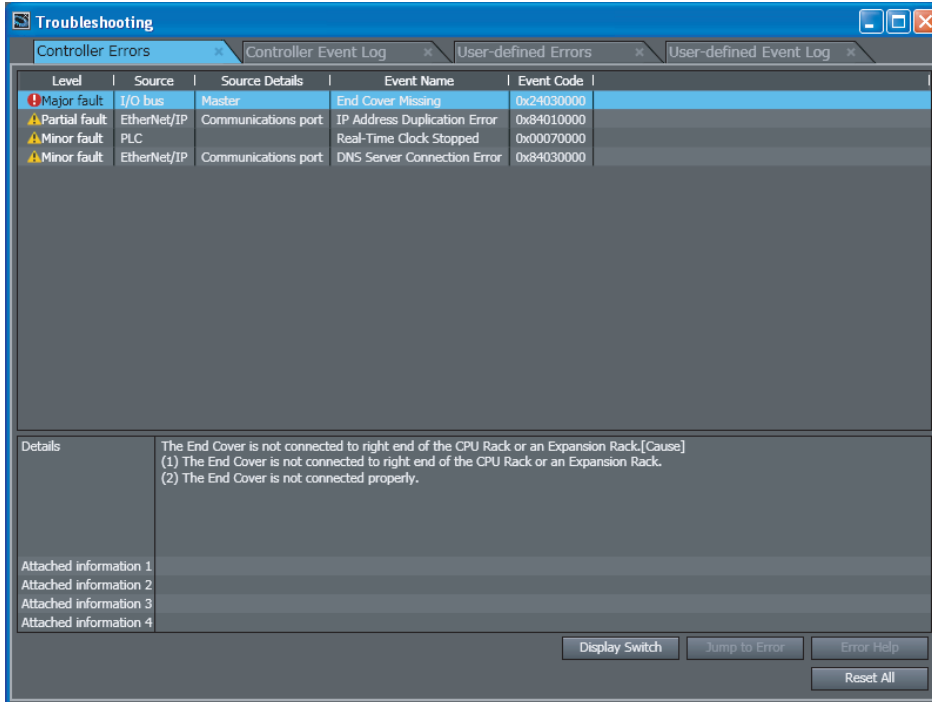

To eliminate the cause of the error, first select the item to perform from the *Action and Correction* list. When you select the appropriate step in the *Action and Correction* list, either the **Jump to Error** or **Error Help** Button is enabled, depending on the contents. In some cases, neither button will operate. Click the enabled button, and proceed with the displayed troubleshooting steps.

After you complete all of the troubleshooting steps for the current errors, click the **Reset All** Button to reset all of the current errors. If the cause of the error is not removed, or if the power supply is not cycled or the Controller is not reset as required after resetting the error, the error will occur again.

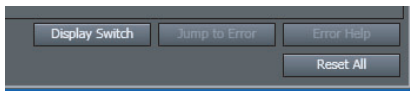

Button	Description
Jump to Error	This button is enabled when the error correction involves a change in the Sysmac Studio settings. When you click the button, the Sysmac Studio will automatically switch to the Editing Pane.
Error Help	The correction methods or the attached information is displayed if it is not possible to jump to the settings display.
Reset All	This button resets all of the current errors, and reads errors again.

It is necessary to synchronize the data between the Sysmac Studio and the connected CPU Unit before you use the **Jump to Error** Button.

For details on synchronization, refer to the *Sysmac Studio Version 1 Operation Manual* (Cat. No. W504)

If you have enabled the verification of operation authority, it is necessary to confirm your authority before you can reset Controller errors.

The Operator, Maintainer, Planning Engineer, and Administrator have the authority to reset errors. For an Operator, however, verification is required each time.

Refer to the *NJ-series CPU Unit Software User's Manual* (Cat. No. W501) for information on operation authority.

All Controller errors are reset when you reset the Controller from the Sysmac Studio. If the cause of the error is not removed, the error will occur again.

2-3-2 Identifying and Resetting Errors with an NS-series PT

You can connect one of the following OMRON NS-series PTs to an NJ-series CPU Unit through an EtherNet/IP network, and use it to read and reset errors that occurred in the Controller. (The Troubleshooter of the PT is used.)

To perform troubleshooting from an NS-series PT, connect the PT to the built-in EtherNet/IP port on the CPU Unit.

- NS8, NS10, NS12, and NS15
NS□-T□01-V2 (The V2 versions have an Ethernet port.)
- NS5
NS5-□Q11-V2 (These models have expanded memory and an Ethernet port.)
- NSJ8, NSJ10, and NSJ12
All models
- NSJ5
NSJ5-□Q11-□ (These models have expanded memory and an Ethernet port.)

The above models of NS-series PTs with system version 8.5 or higher are compatible with the NJ-series Controllers.

Checking for Current Errors with an NS-series PT

You can check for errors in the Controller using the Troubleshooter of an NS-series PT that is compatible with NJ-series Controllers. You can also use the Troubleshooter to read detailed error information and corrections for current errors. Refer to the *NS-series Programmable Terminals Programming Manual* (Cat. No. V073) for details on the NS-series PT's Troubleshooter.

The following example demonstrates the procedure used to check for errors with an NS8, NS10, NS12, or NS15 PT.

You can check the event source in the Function Module View of the Troubleshooter. If you click the **Select** Button for a function module in the *Event source* Table, you can display the *Source details* for events for that function module. You can select the list in the *Source details* Table to display the List View.

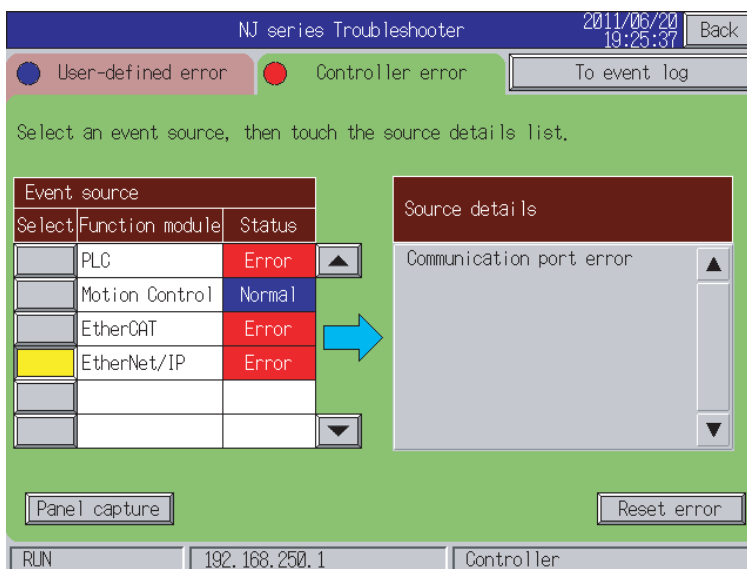

The List View displays a list of the errors produced by the event source that you selected in the Function Module View.

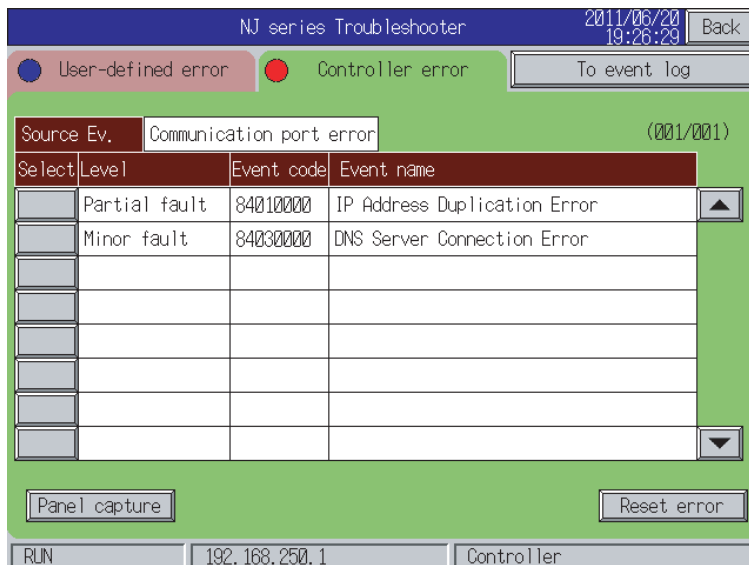

Resetting Errors with an NS-series PT

You can use the Troubleshooter in an NS-series PT to reset errors that occur in the Controller. Before you attempt to reset a Controller error, isolate and remove the cause of the error.

Click the **Select** Button in the List View to display information such as the error's causes and corrections. If you selected the Detail View for the error, the display shows the error's cause and corrections. After you confirm the cause of the displayed error and the conditions in which it occurred, perform the steps in the displayed correction.

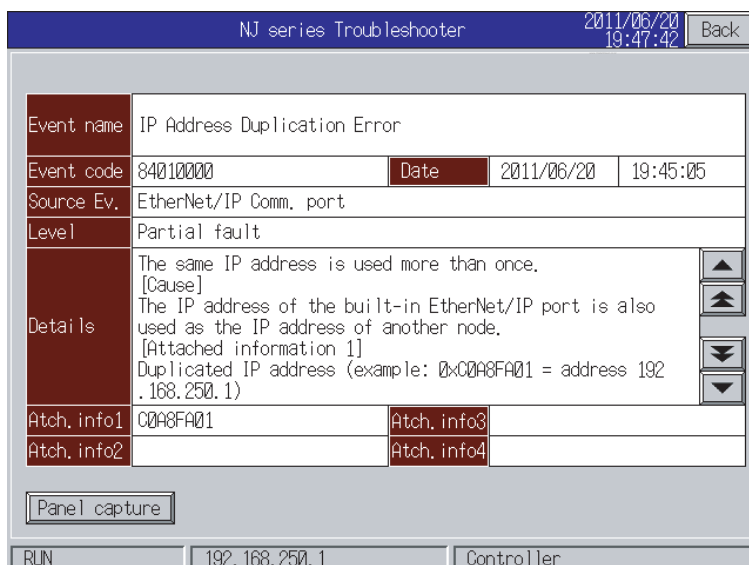

After you complete all of the correction steps for the current errors, click the **Reset error** Button to reset all of the current errors. If the cause of the error is not removed, or if the power supply is not cycled or the Controller is not reset as required after resetting the error, the error will occur again.

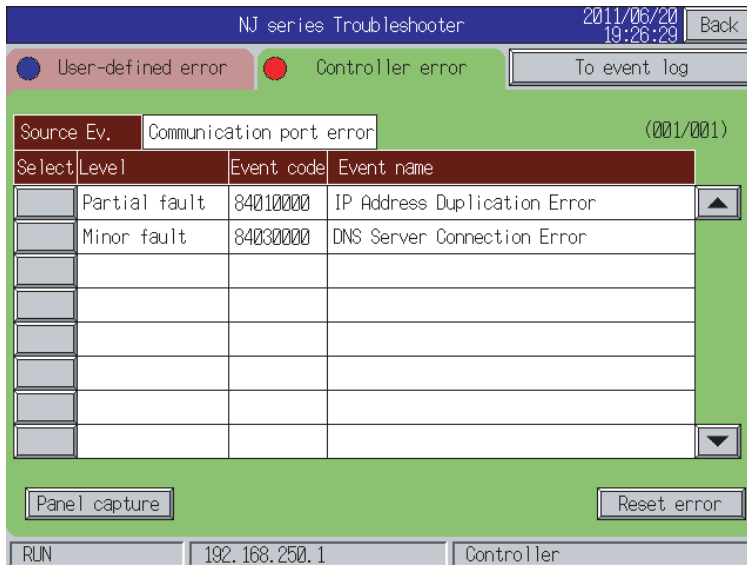

In order to reset the Controller errors, it is necessary to confirm your rights according to the operation authority settings for the Troubleshooter. Refer to the *NS-series Programmable Terminals Programming Manual* (Cat. No. V073) for details on the operation authority.

2-3-3 Identifying and Resetting Errors from the User Program

In an NJ-series Controller, you can check for errors that have occurred from the user program. This feature allows you to program operations in the user program according to the error status. Special instructions are provided for this purpose. These include instructions to get Controller error information and instructions to reset Controller errors.

Instructions That Get Controller Error Information

Determine the error status with the instruction to get error information that is provided for each function module. The following table lists the instruction that are used to get error information for each function module.

Instruction name	Instruction	Function
Get PLC Controller Error Status	GetPLCError	Gets the status and the event code of the error with the highest level of the Controller errors in the PLC Function Module.
Get I/O Bus Error Status	GetCJBError	Gets the status and the event code of the error with the highest level of the Controller errors in the I/O bus.
Get Motion Control Error Status	GetMCError	Gets the status and the event code of the error with the highest level of the Controller errors in the Motion Control Function Module.
Get EtherCAT Error Status	GetECError	Gets the status and the event code of the error with the highest level of the communications port errors and master errors detected by the EtherCAT Master Function Module.
Get EtherNet/IP Error Status	GetEIPErr	Gets the status and the event code of the error with the highest level of the Controller errors in the EtherNet/IP Function Module.

Refer to the *NJ-series Instructions Reference Manual* (Cat. No. W502) for details on these instructions.

Example of Error Detection for the EtherCAT Master Function Module

User-defined Variables

```
trigger: BOOL; //Get condition
ec_error: BOOL; //EtherCAT master error flag
```

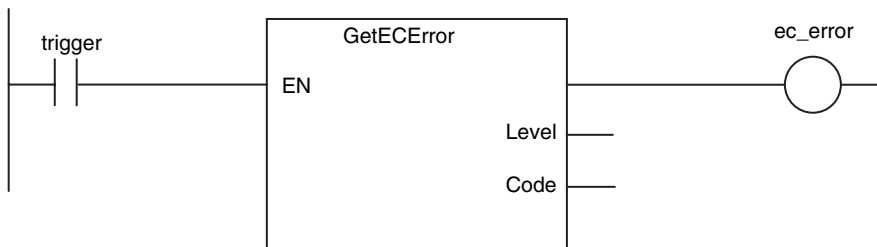

Resetting Controller Errors with Instructions

You can use the instructions that are provided to reset errors in the user program to reset errors that occur in the Controller. Before you attempt to reset a Controller error, isolate and remove the cause of the error. Reset the errors with the instruction provided to reset errors for each function module.

Instruction name	Instruction	Function
Reset PLC Controller Error	ResetPLCError	Resets current Controller errors from the PLC Function Module.
Reset I/O Bus Controller Error	ResetCJBError	Resets current Controller errors from the I/O bus.
Reset Motion Control Error	ResetMCErr	Resets current Controller errors from the Motion Control Function Module.
Reset EtherCAT Error	ResetECCError	Resets current Controller errors from the EtherCAT Master Function Module.

Refer to the *NJ-series Instructions Reference Manual* (Cat. No. W502) for details on these instructions.

2-3-4 Checking for Errors with System-defined Variables

The system-defined variables include an Error Status variable, which shows the error status. The following diagram shows the structure of this variable. The system determines the error status of each level by logically ORing the error status information of the next lower level. You can read the Error Status variable from an external device through communications. Refer to the *NJ-series CPU Unit Software User's Manual* (Cat. No. W501) for information on system-defined variables.

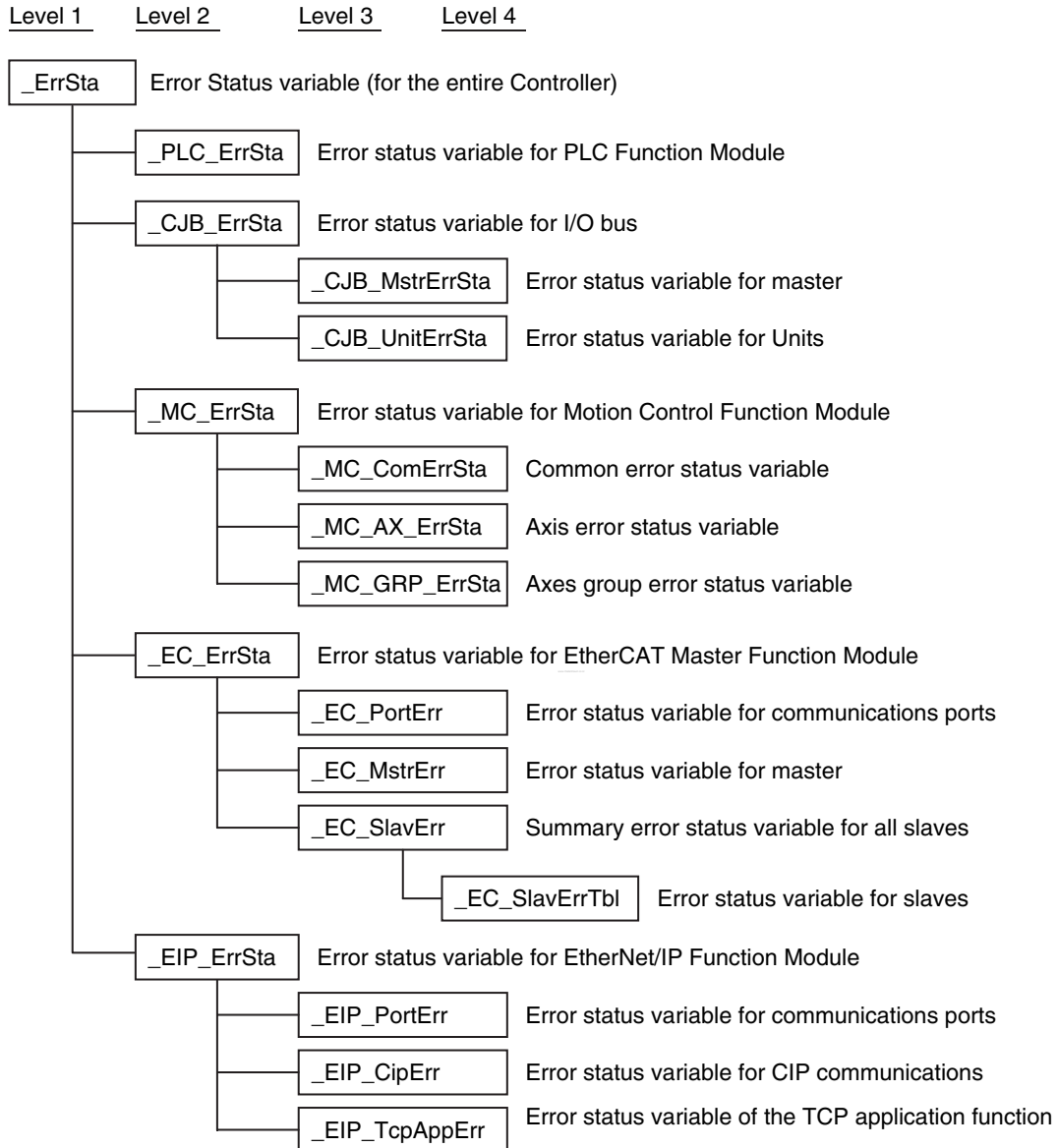

2-4 Troubleshooting When You Cannot Go Online from the Sysmac Studio

The section describes the procedure to troubleshoot when you cannot go online with the CPU Unit from the Sysmac Studio.

2-4-1 Causes and Correction When You Cannot Go Online from the Sysmac Studio

The following table lists the possible causes when you cannot go online with the NJ-series CPU Unit from the Sysmac Studio.

Cause	Description	Correction
Incorrect settings or faulty communications path	There is a mistake in the settings that the Sysmac Studio uses to go online with the CPU Unit. Or, the communications path is faulty.	Refer to <i>Troubleshooting Incorrect Settings and Faulty Communications Path</i> on page 2-15.
Fatal error in the CPU Unit	A fatal error occurred in the CPU Unit.	Refer to <i>2-1-1 Checking to See If the CPU Unit Is Operating</i> .
High system service load	The system service load on the CPU Unit is too high and time cannot be obtained to connect with the Sysmac Studio.	Start in Safe Mode. Refer to <i>Troubleshooting a High System Service Load</i> on page 2-19.

Note If the EtherNet/IP NET ERR indicator on the CPU Unit is lit or flashing, it is possible that you cannot go online through an EtherNet/IP route because of an error in the EtherNet/IP Function Module. See if you can go online with a direct USB connection.

You can use the status of the RUN indicator on the CPU Unit to isolate the cause. Implement the troubleshooting for the applicable cause.

RUN indicator	Causes		
	Incorrect settings or faulty communications path	Fatal error in the CPU Unit	High system service load
No lit.	Cause	Cause	---
Flashing at 3-s intervals.	---	Cause (Incorrect Power Supply Unit connected.)	---
Lit.	Cause	---	Cause

2-4-2 Troubleshooting for Each Cause

This section provides troubleshooting methods for incorrect settings, fault communications paths, and high system service loads.

Troubleshooting Incorrect Settings and Faulty Communications Path

If the Sysmac Studio cannot go online with the CPU Unit, troubleshoot the problem with the following flowchart.

● Direct Connection to Peripheral USB Port

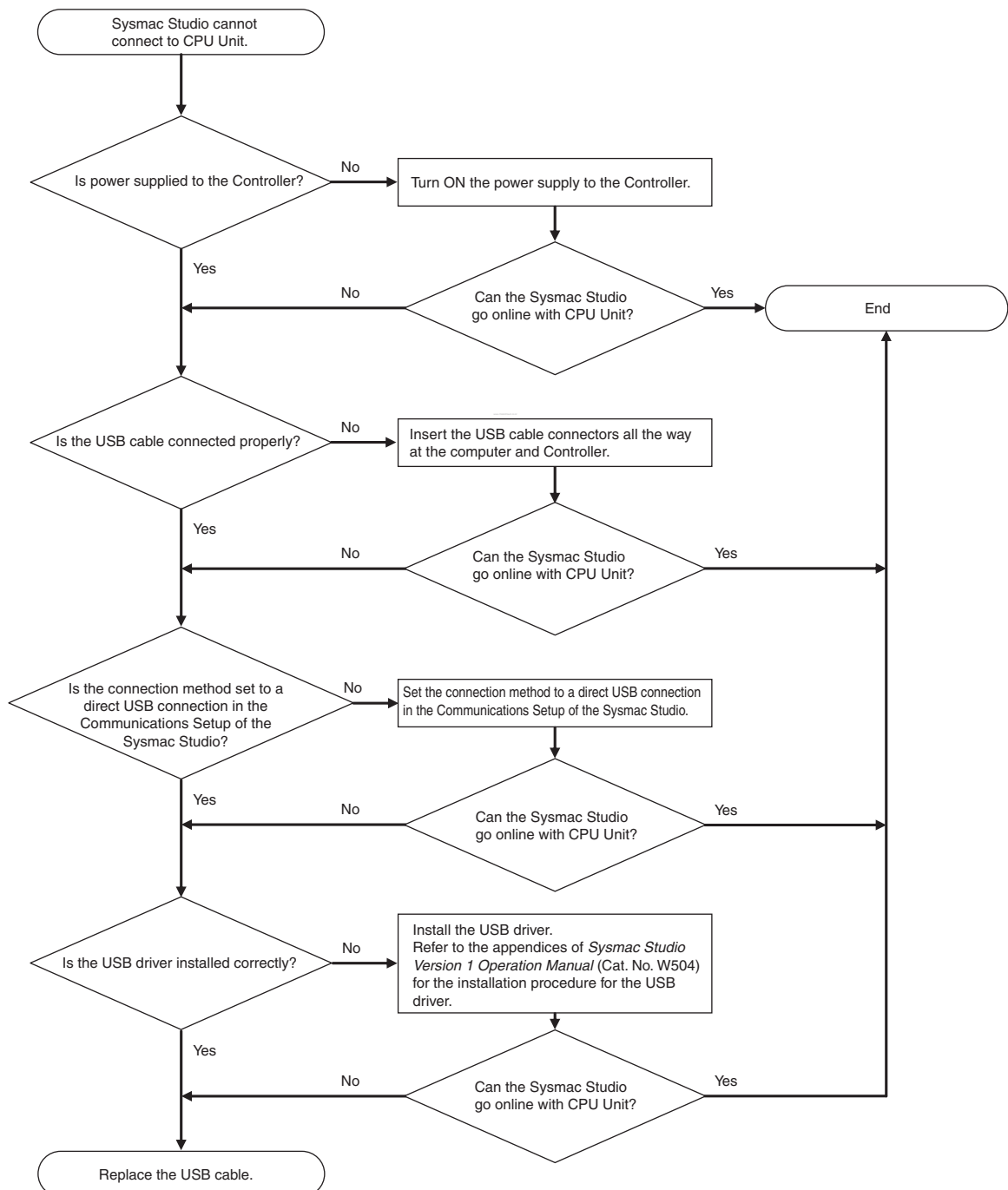

● Remote Connection to Peripheral USB Port

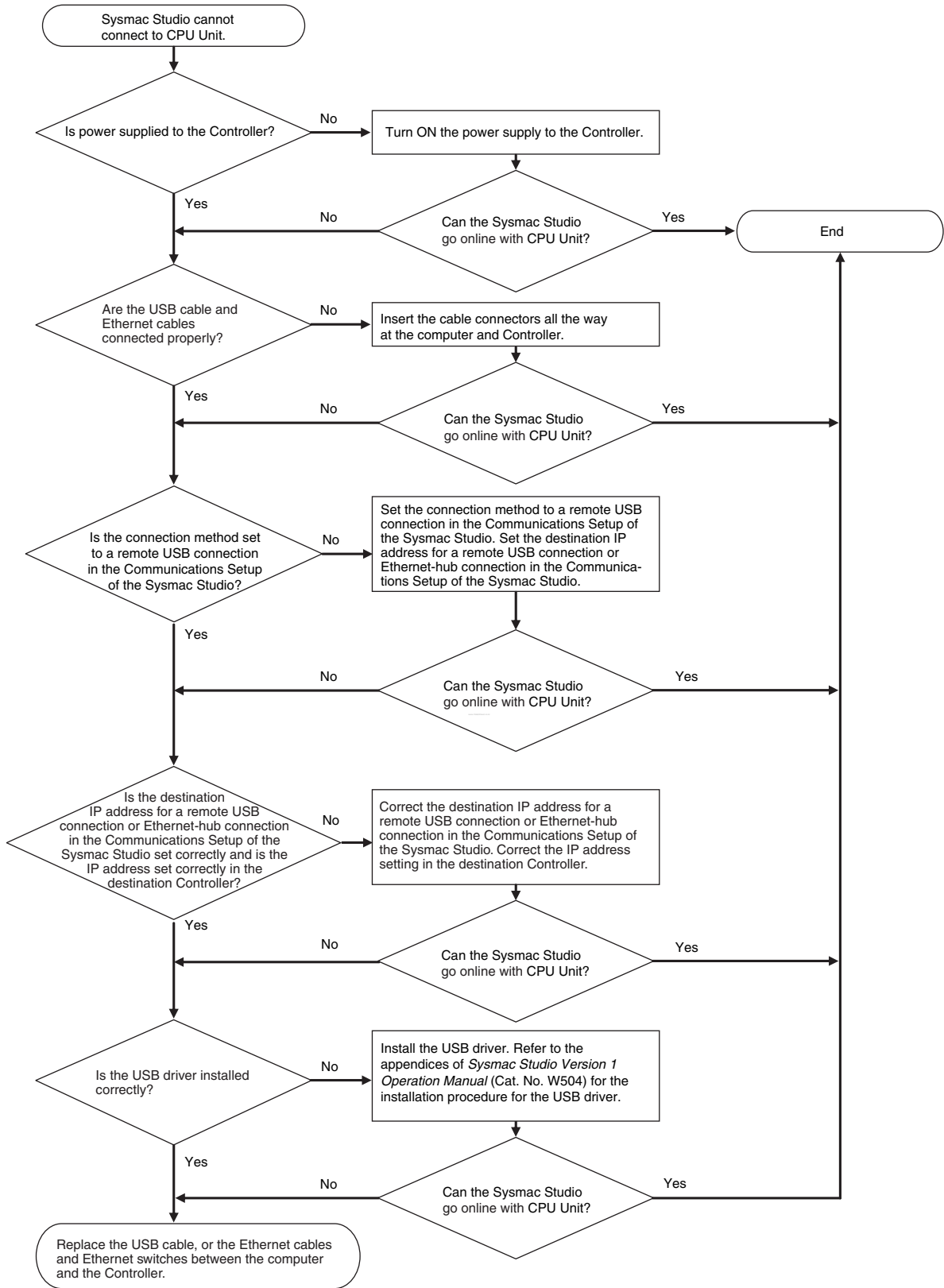

● Direct Connection with EtherNet/IP Port

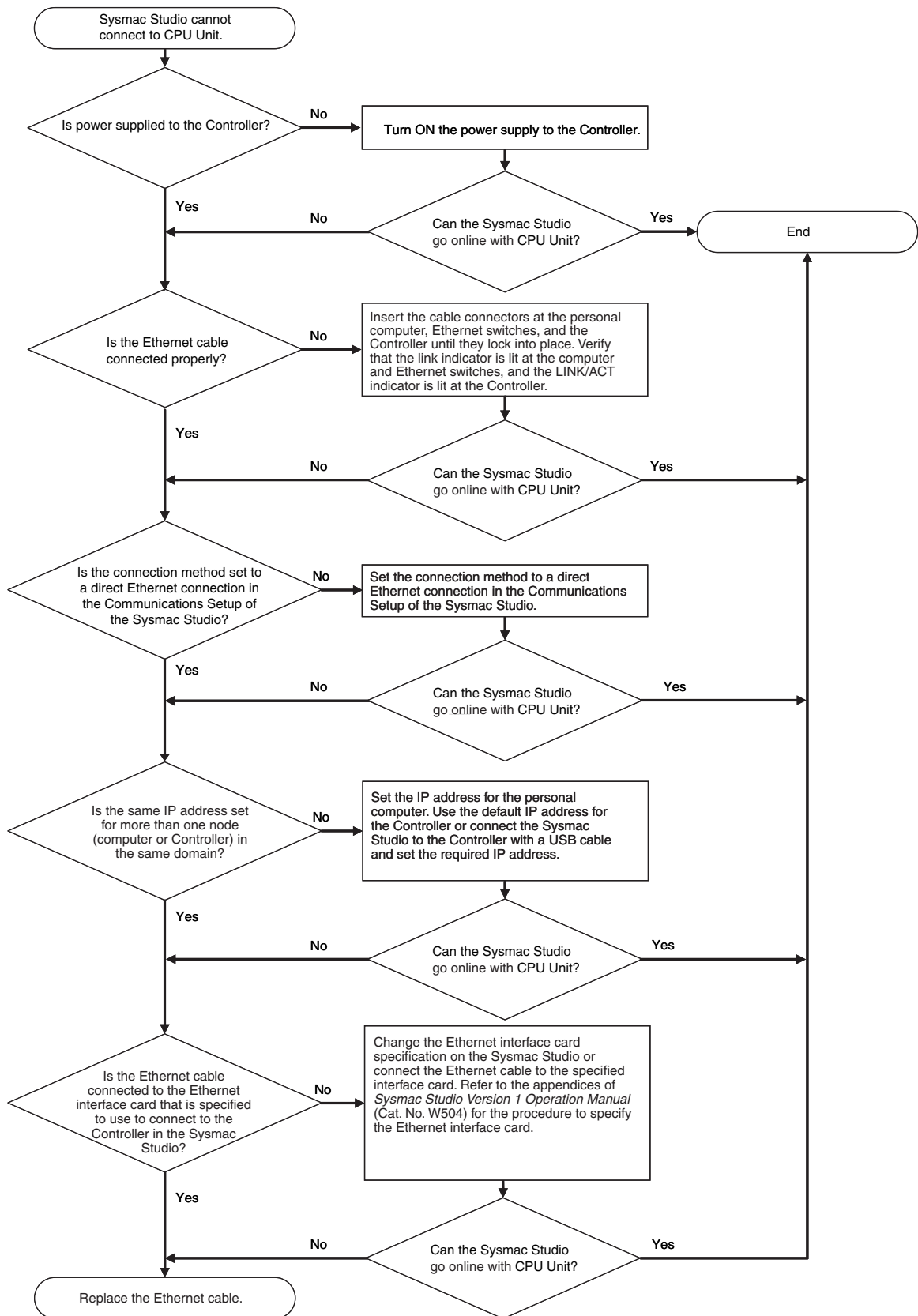

● Ethernet Hub Connection

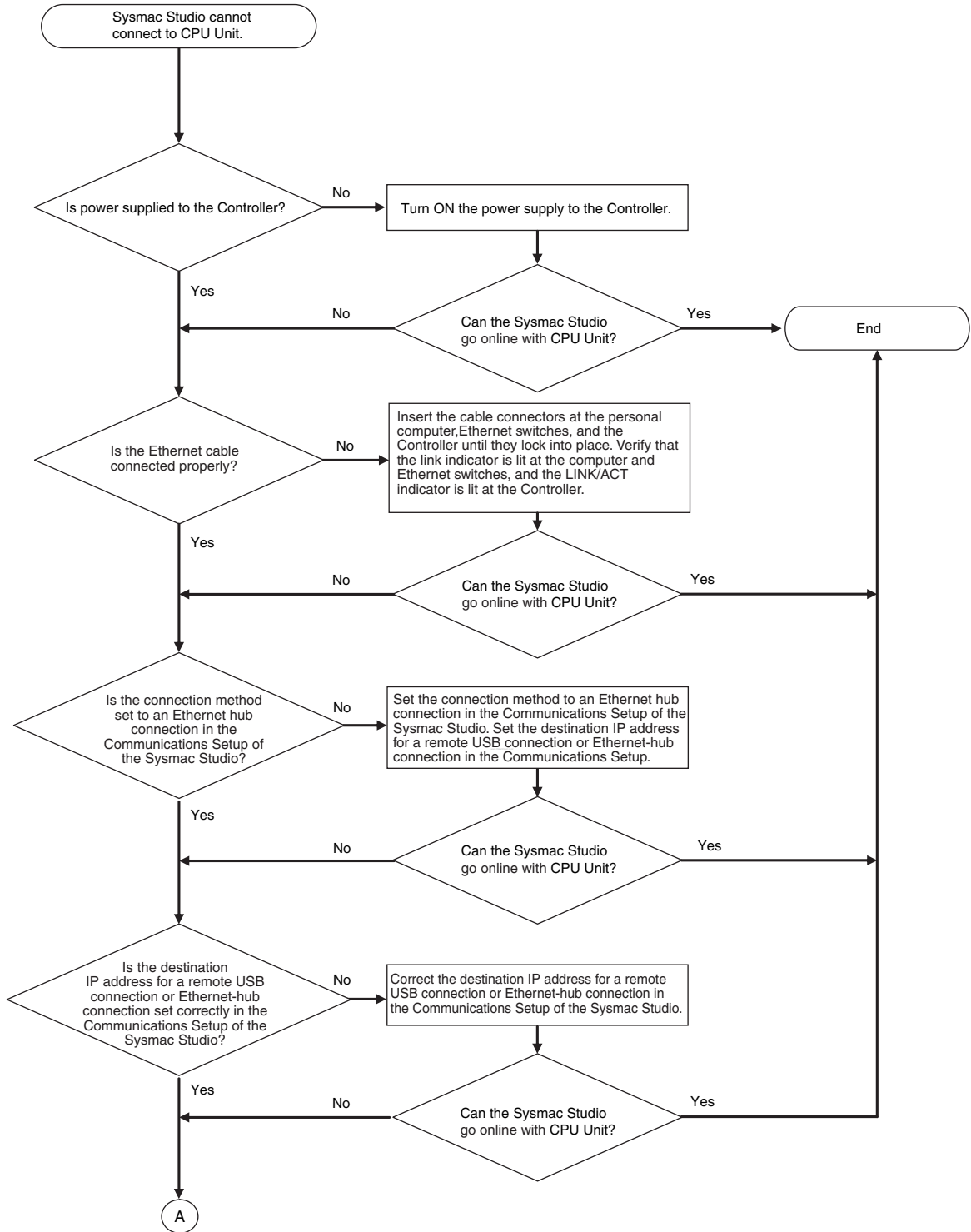

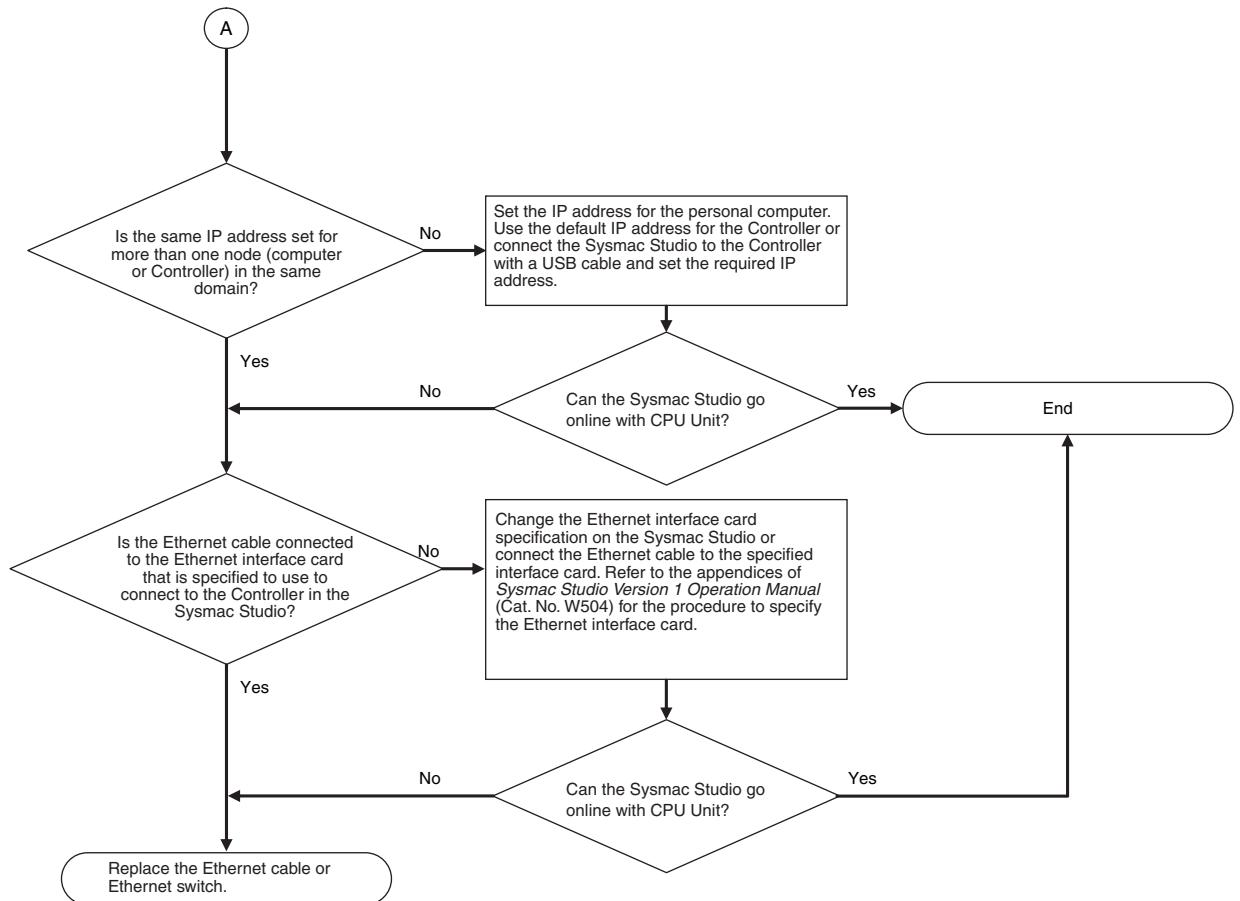

Troubleshooting a High System Service Load

If a high system service load is the problem, you will be able to go online with the CPU Unit from the Sysmac Studio if you start in Safe Mode. Use the following procedure.

- 1 Set on the DIP switch on the CPU Unit as shown below and then cycle the power supply to the Controller.

The CPU Unit will start in Safe Mode.

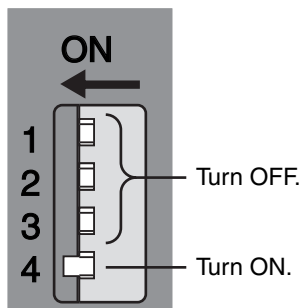

- 2 Go online with the CPU Unit from the Sysmac Studio and perform the required operation.
Ensure that there is sufficient system service time to enable the Sysmac Studio to go online with the CPU Unit. To do so, either increase the period of the primary periodic task or decrease the sizes of the programs in the primary periodic task. Refer to *NJ-series CPU Unit Software User's Manual* (Cat. No. W501) for information on setting the primary periodic task.
- 3 Turn OFF all DIP switch pins and then cycle the power supply to the Controller to restore normal CPU Unit operation.

● Safe Mode Operation

In Safe Mode, the CPU Unit does not execute the user program even in RUN mode. This increases the ratio of system service processing that is performed by the CPU Unit, which makes it easier for the Sysmac Studio to go online with the CPU Unit. A major fault level Controller error will occur and a “Safe Mode” event is recorded in the event log. Refer to *1-3-1 Types of Non-fatal Errors* for information on operation for a major fault level Controller error.

3

Error Tables

This section lists all of the errors (events) that can occur on NJ-series Controllers.

3-1	Errors by Source	3-2
3-1-1	Interpreting Error Descriptions	3-2
3-1-2	Errors in the PLC Function Module	3-2
3-1-3	Errors in the Motion Control Function Module	3-11
3-1-4	Errors in the EtherNet/IP Function Module	3-37
3-1-5	Errors in the EtherCAT Master Function Module	3-41
3-1-6	Errors in EtherCAT Slaves	3-44
3-1-7	Errors in CJ-series Units	3-60
3-2	Events in Order of Event Codes	3-79
3-2-1	Interpreting Error Descriptions	3-79
3-2-2	Error Table	3-80
3-3	Instruction Error Table	3-98
3-3-1	Interpreting Error Descriptions	3-98
3-3-2	Error Table	3-98

3-1 Errors by Source

This section provides tables of errors (events) by source. Within each source, errors are given by functional classifications. Events that are not errors are also given in the tables.

3-1-1 Interpreting Error Descriptions

The contents of the error tables are described below.

Item	Description
Event code	The event code of the error in the NJ-series Controller is given. The codes are given in eight hexadecimal digits.
Event name	The name of the error is given
Meaning	A short description of the error is given.
Assumed cause	The assumed cause of the error is given
Level	The level of influence on control is given. The following abbreviations are used and the applicable level is indicated in the tables. Maj: Major fault level Prt: Partial fault level Min: Minor fault level Obs: Observation Info: Information
Reference	The name and catalog number of the manual that provides details on the event are given.

A version in parentheses in the *Event code* column is the unit version of the CPU Unit when the event code was added.

Refer to the manual given in the *Reference* column in the tables for detailed information on an error.

3-1-2 Errors in the PLC Function Module

The section provides tables of the events that can occur in the PLC Function Module. They are divided into the following functional classifications.

- Self-diagnosis
- Unit configuration
- Tasks
- Controller operation
- FINS communications

Errors for Self Diagnosis

Event code	Event name	Meaning	Assumed cause	Level					Reference
				Maj	Prt	Min	Obs	Info	
00090000 hex	DIP Switch Setting Error	An error was detected in the DIP switch setting.	<ul style="list-style-type: none"> There is an error in the DIP switch setting. 	√					NJ-series CPU Unit Hardware User's Manual (Cat. No. W500)
000D0000 hex	Internal NJ-series Bus Check Error	A fatal error was detected on the internal bus.	<ul style="list-style-type: none"> Conductive material has gotten inside. Noise The CPU Unit has failed. 	√					Same as above.
000E0000 hex	Non-volatile Memory Life Exceeded	The specified number of deletions for non-volatile memory was exceeded. Or, the number of bad blocks in memory exceeded the specified value.	<ul style="list-style-type: none"> Non-volatile memory life expired. 	√					Same as above.
10010000 hex	Non-volatile Memory Restored or Formatted	An error was detected in the non-volatile memory check and file system recovery or formatting was executed. Previous files may have been deleted.	<ul style="list-style-type: none"> The Controller power supply was turned OFF while the BUSY indicator was lit. The power supply to the Controller was interrupted momentarily while the BUSY indicator was lit. 	√					Same as above.
10020000 hex	Non-volatile Memory Data Corrupted	A file that must be in non-volatile memory is missing or corrupted.	<ul style="list-style-type: none"> The Controller power supply was turned OFF while the BUSY indicator was lit. The power supply to the Controller was interrupted momentarily while the BUSY indicator was lit. The CPU Unit has failed. 	√					Same as above.
10080000 hex	Main Memory Check Error	An error was detected in the memory check of the main memory in the CPU Unit.	<ul style="list-style-type: none"> Conductive material has gotten inside. Noise There is a software error. The CPU Unit has failed. 	√					Same as above.
00070000 hex	Real-Time Clock Stopped	The oscillation of the real-time clock stopped. The real-time clock is set to an illegal time.	<ul style="list-style-type: none"> The battery voltage is low. The battery connector has come loose. The Battery is missing. 			√			Same as above.
00080000 hex	Real-Time Clock Failed	The real-time clock in the CPU Unit failed.	<ul style="list-style-type: none"> The CPU Unit clock has failed. 			√			Same as above.
000B0000 hex	Low Battery Voltage	The voltage of the Battery has dropped.	<ul style="list-style-type: none"> The battery voltage is low. The battery connector has come loose. The Battery is missing. 			√			Same as above.
10090000 hex	Battery-backup Memory Check Error	An error was detected in the memory check of the battery-backup memory in the CPU Unit.	<ul style="list-style-type: none"> The battery voltage is low. The battery connector has come loose. The Battery is missing. 			√			Same as above.

Event code	Event name	Meaning	Assumed cause	Level					Reference
				Maj	Prt	Min	Obs	Info	
000C0000 hex	CPU Unit Overheat	The temperature inside the CPU Unit exceeded the specified value.	<ul style="list-style-type: none"> The ambient operating temperature is too high. 				√		NJ-series CPU Unit Hardware User's Manual (Cat. No. W500)
000F0000 hex	SD Memory Card Invalid Type	The current SD Memory Card is not supported.	<ul style="list-style-type: none"> An SD Memory Card that is not supported was inserted into the CPU Unit. 				√		Same as above.
00100000 hex	SD Memory Card Life Exceeded	The specified number of deletions for the SD Memory Card was exceeded. Or, the number of bad blocks exceeded the specified value.	<ul style="list-style-type: none"> The service life of the SD Memory Card was exceeded. 				√		Same as above.
10030000 hex	SD Memory Card Invalid Format	The file format of the SD Memory Card is not FAT16 or FAT32.	<ul style="list-style-type: none"> The file format of the SD Memory Card inserted in the CPU Unit is not FAT16 or FAT32. 				√		Same as above.
10040000 hex	SD Memory Card Restored or Formatted	An error was detected during the file system check and the file system was restored. Files may have been deleted.	<ul style="list-style-type: none"> The Controller power supply was turned OFF while the SD BUSY indicator was lit. The power supply to the Controller was interrupted momentarily while the SD BUSY indicator was lit. The SD Memory Card was removed while the SD PWR indicator was lit.— The SD Memory Card is damaged. 				√		Same as above.
10060000 hex	SD Memory Card Data Corrupted	A file that must be in the SD Memory Card is missing or corrupted.	<ul style="list-style-type: none"> The Controller power supply was turned OFF while the SD BUSY indicator was lit. The power supply to the Controller was interrupted momentarily while the SD BUSY indicator was lit. The SD Memory Card was removed while the SD PWR indicator was lit. The SD Memory Card is damaged. 				√		Same as above.
10070000 hex	SD Memory Card Access Power OFF Error	The power supply to the Controller was interrupted during access to the SD Memory Card.	<ul style="list-style-type: none"> The Controller power supply was turned OFF while the SD BUSY indicator was lit. The power supply to the Controller was interrupted momentarily while the SD BUSY indicator was lit. 				√		Same as above.

Errors Related to Unit Configuration

Event code	Event name	Meaning	Assumed cause	Level					Reference
				Maj	Prt	Min	Obs	Info	
04010000 hex	I/O Bus Check Error	An error occurred in a bus line transmission between the CPU Unit and the Units in the rack slots. Or, detection of all Special I/O Units and CPU Bus Units was not completed when the power supply to the Controller was turned ON.	<ul style="list-style-type: none"> The I/O Connecting Cable is disconnected or wires inside it are broken. Conductive material has gotten inside. The connector contact is faulty due to foreign material in the connector. Noise A Unit has failed. 	√					NJ-series CPU Unit Hardware User's Manual (Cat. No. W500)
24010000 hex	Unsupported Unit Detected	An unsupported CJ-series Unit or Power Supply Unit is mounted.	<ul style="list-style-type: none"> An unsupported CJ-series Unit or Power Supply Unit was detected. 	√					Same as above.
24020000 hex	Too Many I/O Points	The total number of I/O points in the connected CJ-series Units exceeds the maximum specified value of the CPU Unit.	<ul style="list-style-type: none"> The total number of I/O points in the connected CJ-series Basic I/O Units exceeds 2,560. 	√					Same as above.
24030000 hex	End Cover Missing	The End Cover is not connected to right end of the CPU Rack or an Expansion Rack.	<ul style="list-style-type: none"> The End Cover is not connected to right end of the CPU Rack or an Expansion Rack. The End Cover is not connected properly. 	√					Same as above.
24040000 hex	Incorrect Unit/Expansion Rack Connection	The number of Units or Expansion Racks exceeds the maximum value specified for the CPU Unit. Or, an Interrupt Input Unit was mounted to a unsupported slot or to an Expansion Rack.	<ul style="list-style-type: none"> More than 10 Units are connected to one Rack. More than three Expansion Racks are connected. More than two Interrupt Input Units are mounted. An Interrupt Input Unit was mounted to a unsupported slot or to an Expansion Rack. 	√					Same as above.
24050000 hex	Duplicate Unit Number	The same unit number is set for more than one Special I/O Unit or more than one CPU Bus Unit.	<ul style="list-style-type: none"> The same unit number is set for more than one Special I/O Unit or more than one CPU Bus Unit. The same unit number is assigned to a Special I/O Unit that uses more than one unit number and another Special I/O Unit. 	√					Same as above.

Event code	Event name	Meaning	Assumed cause	Level					Reference
				Maj	Prt	Min	Obs	Info	
34010000 hex	I/O Setting Check Error	There is an inconsistency between a Unit model in the Unit Configuration in the CPU Unit and the Unit model that is mounted in the Controller.	<ul style="list-style-type: none"> A Unit model in the Unit Configuration in the CPU Unit is different from the Unit model that is mounted in the Controller. 	√					NJ-series CPU Unit Hardware User's Manual (Cat. No. W500)
64010000 hex	Impossible to Access Special Unit	An error occurred in data exchange between the CPU Unit and a Special Unit.	<ul style="list-style-type: none"> An error occurred in the Special Unit. The Unit connection is faulty. Noise A Unit has failed. 			√			Same as above.
80010000 hex	Illegal Packet Discarded	An illegal packet was received during message communications. The illegal packet was discarded.	<ul style="list-style-type: none"> Noise 				√		Same as above.

Errors Related to Tasks

Event code	Event name	Meaning	Assumed cause	Level					Reference
				Maj	Prt	Min	Obs	Info	
60020000 hex	Task Execution Timeout	Task execution exceeded the timeout detection time.	<ul style="list-style-type: none"> The timeout detection time setting is too short. The task period setting is too short. A user program is too large. The number of times that processing is repeated is larger than expected. The priority of the periodic task is incorrect. 	√					NJ-series CPU Unit Software User's Manual (Cat. No. W501)
60030000 hex	I/O Refreshing Timeout Error	Consecutive I/O refresh failures occurred during the primary periodic task or periodic task period.	<ul style="list-style-type: none"> The task period setting is too short. The priority of the periodic task is incorrect. There are too many Units and slaves that perform I/O refresh in the task period. 	√					Same as above.
60040000 hex	Insufficient System Service Time Error	The specified system service execution time could not be obtained.	<ul style="list-style-type: none"> There is no unused time available for task execution. The system service execution interval is too short or the system service execution time ratio is too long in the system service execution time settings. 	√					Same as above.
60010000 hex	Task Period Exceeded	Task execution was not completed during the set task period for the primary periodic task or a periodic task.	<ul style="list-style-type: none"> The task period setting is too short. A user program is too large. The number of times that processing is repeated is larger than expected. The priority of the periodic task is incorrect. 			√			Same as above.

Event code	Event name	Meaning	Assumed cause	Level					Reference
				Maj	Prt	Min	Obs	Info	
60050000 hex	Task Period Exceeded	Task execution was not completed during the set task period for the primary periodic task or fixed periodic task.	<ul style="list-style-type: none"> The task period setting is too short. A user program is too large. The number of times that processing is repeated is larger than expected. The priority of the periodic task is incorrect. 				√		NJ-series CPU Unit Software User's Manual (Cat. No. W501)

Errors Related to Controller Operation

Event code	Event name	Meaning	Assumed cause	Level					Reference
				Maj	Prt	Min	Obs	Info	
10200000 hex	User Program/Controller Configurations and Setup Transfer Error	The user program or Controller Configurations and Setup were not transferred correctly.	<ul style="list-style-type: none"> The user program or Controller Configurations and Setup are not correct because the power supply to the Controller was interrupted or communications with the Sysmac Studio were disconnected during a download of the user program or the Controller Configurations and Setup. The user program or Controller Configurations and Setup are not correct because the power supply to the Controller was interrupted during online editing. The user program or Controller Configurations and Setup are not correct because the power supply to the Controller was interrupted during a Clear All Memory operation. Non-volatile memory failed. 	√					NJ-series CPU Unit Hardware User's Manual (Cat. No. W500) NJ-series CPU Unit Software User's Manual (Cat. No. W501)
10210000 hex	Illegal User Program Execution ID	The user program execution IDs set in the user program and in the CPU Unit do not match.	<ul style="list-style-type: none"> The user program execution IDs set in the user program and in the CPU Unit do not match. A user program execution ID is set in the CPU Unit but not in the user program. 	√					Same as above.
10240000 hex	Illegal User Program	The user program is not correct.	<ul style="list-style-type: none"> There are more than 8 nesting levels for functions or function blocks. 	√					Same as above.
10250000 hex	Illegal User Program/Controller Configurations and Setup	The user program or Controller Configurations and Setup is corrupted.	<ul style="list-style-type: none"> Illegal data was transferred for the user program or Controller Configurations and Setup. Non-volatile memory is deteriorating or has failed. 	√					Same as above.
40160000 hex	Safe Mode	The Controller started in Safe Mode.	<ul style="list-style-type: none"> The power supply was turned ON to the Controller when Safe Mode was set on the DIP switch on the CPU Unit. 	√					Same as above.
10230000 hex	Event Log Restoration Error	Restoring the event log failed.	<ul style="list-style-type: none"> A low battery voltage prevented retention of memory during a power interruption. 				√		Same as above.

Event code	Event name	Meaning	Assumed cause	Level					Reference
				Maj	Prt	Min	Obs	Info	
10260000 hex	Trace Setting Transfer Failure	The power supply was interrupted while transferring the trace settings.	<ul style="list-style-type: none"> The power supply was interrupted while transferring the trace settings. 				√		NJ-series CPU Unit Hardware User's Manual (Cat. No. W500) NJ-series CPU Unit Software User's Manual (Cat. No. W501)
90010000 hex	Clock Changed	The clock time was changed.	<ul style="list-style-type: none"> The clock time was changed. 					√	Same as above.
90020000 hex	Time Zone Changed	The time zone was changed.	<ul style="list-style-type: none"> The time zone was changed. 					√	Same as above.
90080000 hex	Variable Changed to TRUE with Forced Refreshing	Changing a variable to TRUE with forced refreshing was specified.	<ul style="list-style-type: none"> Changing a variable to TRUE with forced refreshing was specified by the user. 					√	Same as above.
90090000 hex	Variable Changed to FALSE with Forced Refreshing	Changing a variable to FALSE with forced refreshing was specified.	<ul style="list-style-type: none"> Changing a variable to FALSE with forced refreshing was specified by the user. 					√	Same as above.
900A0000 hex	All Forced Refreshing Cleared	Clearing all forced refreshing values was specified.	<ul style="list-style-type: none"> Clearing all forced refreshing values was specified by the user. 					√	Same as above.
900B0000 hex	Memory All Cleared	All of memory was cleared.	<ul style="list-style-type: none"> A user with Administrator rights cleared all of the memory. 					√	Same as above.
900C0000 hex	Event Log Cleared	The event log was cleared.	<ul style="list-style-type: none"> The event log was cleared by the user. 					√	Same as above.
90110000 hex	Power Turned ON	The power supply was turned ON.	<ul style="list-style-type: none"> The power supply was turned ON. 					√	Same as above.
90120000 hex	Power Interrupted	The power supply was interrupted.	<ul style="list-style-type: none"> The power supply was interrupted. 					√	Same as above.
90130000 hex	Operation Started	Operation was started.	<ul style="list-style-type: none"> A command to start operation was received. 					√	Same as above.
90140000 hex	Operation Stopped	Operation was stopped.	<ul style="list-style-type: none"> A command to stop operation was received. 					√	Same as above.
90150000 hex	Reset Executed	A reset was executed.	<ul style="list-style-type: none"> A reset command was received. 					√	Same as above.
90160000 hex	User Program Execution ID Write	The user program execution ID was set or changed in the CPU Unit.	<ul style="list-style-type: none"> A user with Administrator rights changed the user program execution ID that is set in the CPU Unit. 					√	Same as above.
90180000 hex	All Controller Errors Cleared	All current errors were cleared.	<ul style="list-style-type: none"> The user cleared all current errors. 					√	Same as above.
90190000 hex	Forced Refreshing Cleared	Clearing a forced refreshing value was specified.	<ul style="list-style-type: none"> Clearing a forced refreshing value was specified by the user. 					√	Same as above.

Errors Related to FINS Communications

Event code	Event name	Meaning	Assumed cause	Level					Reference
				Maj	Prt	Min	Obs	Info	
14010000 hex	CPU Bus Unit Setup Area Error	An error was detected in the memory check of the Setup Area for CPU Bus Units.	<ul style="list-style-type: none"> The power supply to the Controller was interrupted or communications with the Sysmac Studio were disconnected while downloading the CPU Bus Unit Settings. 			√			NJ-series CPU Unit Hardware User's Manual (Cat. No. W500) NJ-series CPU Unit Software User's Manual (Cat. No. W501)
34100000 hex	IP Address Table Setting Error	The IP address table settings are incorrect.	<ul style="list-style-type: none"> The IP address conversion method is set to the combined method or the IP address table settings are incorrect. 			√			Same as above.
34110000 hex	Unknown Destination Node	The send destination node is not known.	<ul style="list-style-type: none"> The send destination node was not found when a FINS message was sent. 			√			Same as above.
34130000 hex	FINS/TCP Connection Table Setting Error	The FINS/TCP connection table is incorrect.	<ul style="list-style-type: none"> The power supply to the Controller was interrupted or communications with the Sysmac Studio were disconnected while downloading the FINS/TCP connection table. 			√			Same as above.
80100000 hex	Packet Discarded	One or more packets were discarded.	<ul style="list-style-type: none"> A FINS response addressed to the CPU Unit was received. The send designation Unit for the FINS response does not exist. 				√		Same as above.
80110000 hex	Packet Discarded	One or more packets were discarded.	<ul style="list-style-type: none"> An attempt was made to send a FINS response with over 2002 bytes. An attempt was made to route a FINS response with over 2002 bytes. Packet was received with a No Such Unit routing error. Packet was received with a Routing Error routing error. Packet was received with a No Routing Table routing error. Packet was received with a No Routing Table routing error. Packet was received with an Event Area Size Over Limit routing error. There is insufficient space in the internal buffer. FINS message routing failed because the communications load is too high. 				√		Same as above.

Event code	Event name	Meaning	Assumed cause	Level					Reference
				Maj	Prt	Min	Obs	Info	
80120000 hex	Packet Discarded	One or more packets were discarded.	<ul style="list-style-type: none"> • A FINS response was received in which DNA was the local network but DA1 was not the local node. • A FINS command or response was received in which the hub network address specification DNA was greater than or equal to 80 hex. • There is insufficient space in the internal buffer. • A FINS command that does not have the minimum command length was received. • A FINS command that exceeded the maximum command length was received. • Sending packets failed. • FINS message routing failed because the communications load was too high. 				√		NJ-series CPU Unit Hardware User's Manual (Cat. No. W500) NJ-series CPU Unit Software User's Manual (Cat. No. W501)

3-1-3 Errors in the Motion Control Function Module

The section provides tables of the errors (events) that can occur in the Motion Control Function Module. They are divided into the following functional classifications.

- General motion control
- Motion control instructions

Motion control instruction errors occur when a motion control instruction is executed. Notification of these errors is provided as events, but also the upper four digits of the event code is output to the *ErrorID* output variable of the motion control instruction and to the **.Lvl.Code* system-defined variable for motion control.

General Motion Control

Event code	Event name	Meaning	Assumed cause	Level					Reference	
				Maj	Prt	Min	Obs	Info		
10200000 hex	User Program/Controller Configurations and Setup Transfer Error	The user program or Controller Configurations and Setup were not transferred correctly.	<ul style="list-style-type: none"> • The user program or Controller Configurations and Setup are not correct because the power supply to the Controller was interrupted or communications with the Sysmac Studio were disconnected during a download of the user program or the Controller Configurations and Setup. • The user program or Controller Configurations and Setup are not correct because the power supply to the Controller was interrupted during online editing. • The user program or Controller Configurations and Setup are not correct because the power supply to the Controller was interrupted during a Clear All Memory operation. • Non-volatile memory failed. 	√						NJ-series CPU Unit Motion Control User's Manual (Cat. No. W507)
14600000 hex	Absolute Encoder Home Offset Read Error	The absolute encoder current position that is retained during power interruptions was lost.	<ul style="list-style-type: none"> • The life of the Battery in the CPU Unit has expired. • Backup memory failure 		√					Same as above.
14610000 hex	Motion Control Parameter Setting Error	The MC parameters that were saved in non-volatile memory are missing.	<ul style="list-style-type: none"> • The power supply to the Controller was interrupted or communications with the Sysmac Studio were disconnected while downloading the motion control parameter settings or clearing memory. • Non-volatile memory failure 		√					Same as above.
14620000 hex	Cam Data Read Error	The cam data that was saved in non-volatile memory is missing.	<ul style="list-style-type: none"> • Power was interrupted during save processing for cam data • Non-volatile memory failure 		√					Same as above.
34600000 hex	Required Process Data Object Not Set	The object that is required for the axis type is not allocated to PDO.	<ul style="list-style-type: none"> • The required PDOs are not mapped when the axis type is set to a servo axis or encoder axis. • Non-volatile memory failure 		√					Same as above.

Event code	Event name	Meaning	Assumed cause	Level					Reference
				Maj	Prt	Min	Obs	Info	
34630000 hex	Axis Slave Disabled	The slave to which the axis is assigned is disabled.	<ul style="list-style-type: none"> The slave to which the axis is assigned is disabled. 		√				NJ-series CPU Unit Motion Control User's Manual (Cat. No. W507)
34640000 hex	Network Configuration Information Missing for Axis Slave	The network configuration information is not registered for the slave to which the axis is assigned.	<ul style="list-style-type: none"> The EtherCAT network configuration information is not registered for the slave to which the axis is assigned. 		√				Same as above.
44200000 hex	Motion Control Initialization Error	A fatal error occurred in the system and prevented initialization of the Motion Control Function Module.	<ul style="list-style-type: none"> Hardware has failed. 		√				Same as above.
74200000 hex	Motion Control Period Exceeded	Processing for the primary periodic task was not finished within two control periods.	<ul style="list-style-type: none"> The processing load in the primary periodic task is too heavy. 		√				Same as above.
14630000 hex	Cam Table Save Error	Saving a cam table to a file failed.	<ul style="list-style-type: none"> Saving a cam table to a file failed. 				√		Same as above.
54770000 hex	Cam Table Data Error during Cam Motion	The phases are not in ascending order in the cam table.	<ul style="list-style-type: none"> Data containing cam table phases that are not in ascending order was detected during cam motion. The phase and displacement of the start point in the cam table were not 0 during cam operation. The phase of the end point in the cam table when converted to pulses was not 1 pulse or greater during cam operation. 			√			Same as above.
54850000 hex	Immediate Stop Instruction Executed	An Immediate Stop (MC_ImmediateStop) instruction was executed.	<ul style="list-style-type: none"> An Immediate Stop instruction was executed. 			√			Same as above.
54860000 hex	Axes Group Immediate Stop Instruction Executed	An Axes Group Immediate Stop (MC_GroupImmediateStop) instruction was executed.	<ul style="list-style-type: none"> A Group Immediate Stop instruction was executed. 			√			Same as above.
64450000 hex	Positive Software Limit Exceeded	The position exceeded the positive software limit while the axis is in motion.	<ul style="list-style-type: none"> The position exceeded the positive software limit. 			√			Same as above.
64460000 hex	Negative Software Limit Exceeded	The position exceeded the negative software limit while the axis is in motion.	<ul style="list-style-type: none"> The position exceeded the negative software limit. 			√			Same as above.
64470000 hex	In-position Check Time Exceeded	The in-position check was not completed within the monitoring time.	<ul style="list-style-type: none"> Time is required to complete positioning. 			√			Same as above.

Event code	Event name	Meaning	Assumed cause	Level					Reference
				Maj	Prt	Min	Obs	Info	
64480000 hex	Following Error Limit Exceeded	The error between the command current position and actual current value exceeded the Following Error Over Limit Value.	<ul style="list-style-type: none"> The positioning operation has poor following performance and the actual motion is slower than the command. 			√			NJ-series CPU Unit Motion Control User's Manual (Cat. No. W507)
64490000 hex	Immediate Stop Input	The immediate stop input turned ON.	<ul style="list-style-type: none"> An immediate stop input signal was detected. The immediate stop input signal is not connected correctly or the logic setting for the immediate stop input is wrong. 			√			Same as above.
644A0000 hex	Positive Limit Input Detected	The positive limit input turned ON.	<ul style="list-style-type: none"> A positive limit input signal was detected. The positive limit input signal is not connected correctly or the logic setting for the positive limit input is wrong. 			√			Same as above.
644B0000 hex	Negative Limit Input Detected	The negative limit input turned ON.	<ul style="list-style-type: none"> A negative limit input signal was detected. The negative limit input signal is not connected correctly or the logic setting for the negative limit input is wrong. 			√			Same as above.
64560000 hex	Illegal Following Error	The difference between the command position and the actual current position exceeds the range of 30-bit data when converted to pulses.	<ul style="list-style-type: none"> The command current position was restricted so that the axis velocity of the slave axis would not exceed the axis maximum velocity for the specified travel distance. Performance of slave axis positioning operation is poor and the actual motion is slower than the command. 			√			Same as above.
64570000 hex	Servo OFF Error	The Servo was turned OFF for an axis due to an axes group error.	<ul style="list-style-type: none"> The Servo was turned OFF for an axis due to an axes group error. 			√			Same as above.
64580000 hex	Absolute Encoder Current Position Calculation Failed	It was not possible to correctly restore the current position from the absolute encoder information that was saved when power was interrupted.	<ul style="list-style-type: none"> The ring counter setting in the Controller or the ring counter setting in the Servo Drive settings was changed. The position to restore when converted to pulses exceeded the range of signed 40-bit data. 			√			Same as above.
64590000 hex	Home Undefined during Coordinated Motion	Home of the logical axis became undefined during axes group motion or while decelerating to a stop.	<ul style="list-style-type: none"> The command position or actual position overflowed or underflowed for a logical axis in an axes group motion or a logical axis that was decelerating to a stop and the home definition was lost. A slave communications error occurred for a logical axis and home became undefined during axes group motion or while decelerating to a stop. A slave for a logical axis left the network and home became undefined during axes group motion or while decelerating to a stop. 			√			Same as above.

Event code	Event name	Meaning	Assumed cause	Level					Reference
				Maj	Prt	Min	Obs	Info	
74210000 hex	Servo Main Circuit Power OFF	The main circuit power of the Servo Drive turned OFF while the Servo was ON.	<ul style="list-style-type: none"> The main circuit power of the Servo Drive was interrupted while the Servo was ON. 			√			NJ-series CPU Unit Motion Control User's Manual (Cat. No. W507)
74230000 hex	Interrupt Feeding Interrupt Signal Missing	An interrupt input was not received during execution of an MC_MoveFeed (Interrupt Feeding) instruction.	<ul style="list-style-type: none"> The latch enabled range specification is invalid. There is a problem with the wiring of the interrupt signal. The sensor that outputs the interrupt signal has failed. 			√			Same as above.
74240000 hex	Homing Opposite Direction Limit Input Detected	The limit signal in the direction opposite to the homing direction was detected during a homing operation.	<ul style="list-style-type: none"> The Operation Selection at Negative Limit Input or Operation Selection at Positive Limit Input parameter is set to <i>No reverse turn</i>. The location of the homing input signal sensors, homing settings, and homing start position cause a limit input to be reached. The input signal sensor wiring is incorrect or the sensor is faulty. 			√			Same as above.
74250000 hex	Homing Direction Limit Input Detected	The limit signal in the homing direction was detected during a homing operation.	<ul style="list-style-type: none"> The Operation Selection at Negative Limit Input or Operation Selection at Positive Limit Input parameter is set to <i>No reverse turn</i>. The location of the homing input signal sensors, homing settings, and homing start position cause a limit input to be reached. The input signal sensor wiring is incorrect or the sensor is faulty. 			√			Same as above.
74260000 hex	Homing Limit Inputs Detected in Both Directions	The limit signals in both directions were detected during a homing operation.	<ul style="list-style-type: none"> The wiring of the limit signal is incorrect. The limit sensor is installed in the wrong location. The contact logic of the limit signal is not correct. The limit sensor failed. 			√			Same as above.
74270000 hex	Home Proximity/Homing Opposite Direction Limit Input Detected	The home proximity input and the limit signal in the direction opposite to the homing direction were detected during a homing operation.	<ul style="list-style-type: none"> The wiring of the home proximity signal or limit signal is incorrect. The home proximity sensor or limit sensor is installed in the wrong location. The contact logic of the home proximity signal or limit signal is not correct. The home proximity sensor or limit sensor failed. 			√			Same as above.

Event code	Event name	Meaning	Assumed cause	Level					Reference
				Maj	Prt	Min	Obs	Info	
74280000 hex	Home Proximity/Homing Direction Limit Input Detected	The home proximity input and the limit signal in the homing direction were detected at the same time during a homing operation.	<ul style="list-style-type: none"> The wiring of the home proximity signal or limit signal is incorrect. The home proximity sensor or limit sensor is installed in the wrong location. The contact logic of the home proximity signal or limit signal is not correct. The home proximity sensor or limit sensor failed. 			√			NJ-series CPU Unit Motion Control User's Manual (Cat. No. W507)
74290000 hex	Home Input/Homing Opposite Direction Limit Input Detected	The home input and the limit signal in the direction opposite to the homing direction were detected at the same time during a homing operation.	<ul style="list-style-type: none"> The wiring of the home input signal or limit signal is incorrect. The home input sensor or limit sensor is installed in the wrong location. The contact logic of the home input signal or limit signal is not correct. The home input signal output device or limit sensor failed. 			√			Same as above.
742A0000 hex	Home Input/Homing Direction Limit Input Detected	The home input and the limit signal in the homing direction were detected at the same time during a homing operation.	<ul style="list-style-type: none"> The wiring of the home input signal or limit signal is incorrect. The home input sensor or limit sensor is installed in the wrong location. The contact logic of the home input signal or limit signal is not correct. The home input signal output device or limit sensor failed. 			√			Same as above.
742B0000 hex	Invalid Home Input Mask Distance	The setting of the home input mask distance is not suitable for the MC_Home instruction.	<ul style="list-style-type: none"> The set value of the home input mask distance when the operating mode of the MC_Home instruction is set to <i>Proximity Reverse Turn/Home Input Mask Distance</i> is insufficient to decelerate from the homing velocity to the homing approach velocity. 			√			Same as above.
742C0000 hex	No Home Input	There was no home signal input during the homing operation. Or, a limit signal was detected before there was a home input.	<ul style="list-style-type: none"> There was no home signal input during the homing operation. A limit signal was detected before there was a home input. 			√			Same as above.
742D0000 hex	No Home Proximity Input	There was no home proximity signal input during the homing operation.	<ul style="list-style-type: none"> There was no home proximity signal input during the homing operation when a home proximity input signal was specified. 			√			Same as above.
742F0000 hex	Slave Error Detected	An alarm was detected for the EtherCAT slave that is allocated to an axis.	<ul style="list-style-type: none"> An error was detected for the EtherCAT slave that is allocated to the axis. 			√			Same as above.
74300000 hex	Axes Group Composition Axis Error	An error occurred for an axis in an axes group.	<ul style="list-style-type: none"> An error occurred for an axis in an axes group that was in motion. 			√			Same as above.
74330000 hex	MC Common Error Occurrence	An MC common error occurred.	<ul style="list-style-type: none"> Partial fault level MC common error occurred. 			√			Same as above.

Event code	Event name	Meaning	Assumed cause	Level					Reference
				Maj	Prt	Min	Obs	Info	
74340000 hex	Latch Position Overflow	An overflow occurred for the latched position for the MC_TouchProbe (Enable External Latch) instruction.	<ul style="list-style-type: none"> An overflow occurred for the latched position for the MC_TouchProbe (Enable External Latch) instruction. 			√			NJ-series CPU Unit Motion Control User's Manual (Cat. No. W507)
74350000 hex	Latch Position Underflow	An underflow occurred for the latched position for the MC_TouchProbe (Enable External Latch) instruction.	<ul style="list-style-type: none"> An underflow occurred for the latched position for the MC_TouchProbe (Enable External Latch) instruction. 			√			Same as above.
74360000 hex	Master Sync Direction Error	The master axis continued to move in the direction opposite to the sync direction.	<ul style="list-style-type: none"> The master axis continued to move in the direction opposite to the sync direction of the master and slave axes, resulting in an overflow. 			√			Same as above.
74370000 hex	Slave Disconnection during Servo ON	An EtherCAT slave that is allocated to an axis was disconnected while the servo was ON.	<ul style="list-style-type: none"> An EtherCAT slave that is allocated to an axis was disconnected or replaced while the Servo was ON. 			√			Same as above.
74380000 hex	Feed Distance Overflow	The target position after the interrupt input was received for the MC_MoveFeed (Interrupt Feeding) instruction overflowed or underflowed.	<ul style="list-style-type: none"> The target position after the interrupt input was received for the MC_MoveFeed (Interrupt Feeding) instruction exceeded the range of signed 40-bit data when converted to pulses. 			√			Same as above.
74390000 hex	Error in Changing Servo Drive Control Mode	Changing the Control Mode was not completed within the specified time.	<ul style="list-style-type: none"> When the MC_SyncMoveVelocity instruction was stopped, the actual current velocity was not reduced to 10% or less of the maximum velocity within 10 seconds for three consecutive periods after a command velocity of 0 was output. For an OMRON G5-series Servo Drive, the actual current velocity was not reduced to 10% or less of the maximum velocity within 10 seconds for three consecutive periods when the MC_TorqueControl instruction was stopped. Changing the Control Mode of the Servo Drive between CSP, CSV, and CST was not completed within one second after the command was executed. 			√			Same as above.

Event code	Event name	Meaning	Assumed cause	Level					Reference
				Maj	Prt	Min	Obs	Info	
743A0000 hex	Master Axis Position Read Error	The synchronized instruction was not executed because an error occurred in the position of the master axis of the synchronized instruction.	<ul style="list-style-type: none"> EtherCAT process data communications are not established for the master axis of the synchronized instruction. The slave of the master axis for the synchronized instruction was disconnected. An Absolute Encoder Current Position Calculation Failed error (6458000 hex) was detected for the master axis of a synchronized instruction. 			√			NJ-series CPU Unit Motion Control User's Manual (Cat. No. W507)
743B0000 hex	Auxiliary Axis Position Read Error	The synchronized instruction was not executed because an error occurred in the position of the auxiliary axis of the synchronized instruction.	<ul style="list-style-type: none"> EtherCAT process data communications are not established for the auxiliary axis of the synchronized instruction. The slave of the auxiliary axis for the synchronized instruction was disconnected. An Absolute Encoder Current Position Calculation Failed error (6458000 hex) was detected for the auxiliary axis of a synchronized instruction. 			√			Same as above.
84400000 hex	EtherCAT Slave Communications Error	A communications error occurred for the EtherCAT slave that is allocated to an axis.	<ul style="list-style-type: none"> A communications error occurred for the EtherCAT slave that is allocated to an axis. 			√			Same as above.
644C0000 hex	Following Error Warning	The following error exceeded the Following Error Warning Value.	<ul style="list-style-type: none"> Performance of positioning operation is poor and the actual motion is slower than the command. 				√		Same as above.
644D0000 hex	Velocity Warning	The command velocity exceeded the velocity warning value.	<ul style="list-style-type: none"> The command velocity exceeded the velocity warning value. 				√		Same as above.
644E0000 hex	Acceleration Warning	The command acceleration exceeded the acceleration warning value.	<ul style="list-style-type: none"> The command acceleration rate exceeded the acceleration warning value. 				√		Same as above.
644F0000 hex	Deceleration Warning	The command deceleration exceeded the deceleration warning value.	<ul style="list-style-type: none"> The command deceleration rate exceeded the deceleration warning value. 				√		Same as above.
64500000 hex	Positive Torque Warning	The torque command value exceeded the positive torque warning value.	<ul style="list-style-type: none"> The torque command value exceeded the positive torque warning value. 				√		Same as above.
64510000 hex	Negative Torque Warning	The torque command value exceeded the negative torque warning value.	<ul style="list-style-type: none"> The torque command value exceeded the negative torque warning value. 				√		Same as above.
64520000 hex	Command Position Overflow	The number of pulses for the command position overflowed.	<ul style="list-style-type: none"> In Linear Mode, the command position when converted to pulses exceeded the upper limit of signed 40-bit data. 				√		Same as above.

Event code	Event name	Meaning	Assumed cause	Level					Reference
				Maj	Prt	Min	Obs	Info	
64530000 hex	Command Position Underflow	The number of pulses for the command position exceeded the valid range. (It underflowed.)	<ul style="list-style-type: none"> In Linear Mode, the command position when converted to pulses exceeded the lower limit of signed 40-bit data. 				√		NJ-series CPU Unit Motion Control User's Manual (Cat. No. W507)
64540000 hex	Actual Position Overflow	The number of pulses for the actual position overflowed.	<ul style="list-style-type: none"> The actual position when converted to pulses exceeded the upper limit of signed 40-bit data. 				√		Same as above.
64550000 hex	Actual Position Underflow	The number of pulses for the actual position underflowed.	<ul style="list-style-type: none"> The actual position when converted to pulses exceeded the lower limit of signed 40-bit data. 				√		Same as above.
74320000 hex	Slave Observation Detected	A warning has been detected for an EtherCAT slave.	<ul style="list-style-type: none"> A warning was detected for the EtherCAT slave that is allocated to the axis. 				√		Same as above.
743C0000 hex	Cannot Execute Save Cam Table Instruction	You cannot save a cam table to a file when non-volatile memory is being accessed by another operation.	<ul style="list-style-type: none"> An attempt was made to execute the MC_SaveCamTable instruction when another operation was accessing the non-volatile memory (e.g., transfer or data trace operation from the Sysmac Studio). 				√		Same as above.
94200000 hex	Notice of Insufficient Travel Distance to Achieve Blending Transit Velocity	There is not sufficient travel distance to accelerate or decelerate to the transit velocity during blending operation.	<ul style="list-style-type: none"> When the Acceleration/Deceleration Over parameter was set to <i>Use rapid acceleration/deceleration (Blending is changed to Buffered)</i>, the results of profile creation caused the acceleration/deceleration rate to be exceeded when blending was specified, so buffered was used. Blending was specified, but the target position was already reached, so it was changed to Buffered because the profile could not be created. <i>Blending</i> was specified for an interpolation instruction, but based on the results of profile creation, this was changed to <i>Buffered</i> because the execution time of the instruction before the transition was four control periods or less. 				√		Same as above.
94210000 hex	Error Clear from MC Test Run Tab Page	An error was cleared from the MC Test Run Pane of the Sysmac Studio.	<ul style="list-style-type: none"> An error was cleared from the MC Test Run Pane of the Sysmac Studio. 					√	Same as above.
94220000 hex	Slave Error Code Report	The error code was reported by the slave when a Slave Error Detected error occurred.	<ul style="list-style-type: none"> The error code was reported by the slave when a Slave Error Detected error (742F0000 hex) occurred. 					√	Same as above.

Motion Control Instructions

Event code	Event name	Meaning	Assumed cause	Level					Reference
				Maj	Prt	Min	Obs	Info	
34610000 hex	Process Data Object Setting Missing	The PDO mapping is not correct.	<ul style="list-style-type: none"> The PDOs that are required for the motion control instruction are not mapped. A motion control instruction that specifies phase Z (<code>_mcEncoderMark</code>) as the trigger conditions was executed for an axis that is mapped to an OMRON GX-EC02□□ Ether-CAT Encoder slave. 			√			NJ-series Motion Control Instructions Reference Manual (Cat. No. W508)
54200000 hex	Electronic Gear Ratio Numerator Setting Out of Range	The parameter specified for the <i>RatioNumerator</i> input variable to a motion control instruction is out of range.	<ul style="list-style-type: none"> Instruction input parameter exceeded the valid range of the input variable. 			√			Same as above.
54210000 hex	Electronic Gear Ratio Denominator Setting Out of Range	The parameter specified for the <i>RatioDenominator</i> input variable to a motion control instruction is out of range.	<ul style="list-style-type: none"> Instruction input parameter exceeded the valid range of the input variable. 			√			Same as above.
54220000 hex	Target Velocity Setting Out of Range	The parameter specified for the <i>Velocity</i> input variable to a motion control instruction is out of range.	<ul style="list-style-type: none"> The Target Velocity (input variable <i>Velocity</i>) is still at the default (0). 			√			Same as above.
54230000 hex	Acceleration Setting Out of Range	The parameter specified for the <i>Acceleration</i> input variable to a motion control instruction is out of range.	<ul style="list-style-type: none"> Instruction input parameter exceeded the valid range of the input variable. 			√			Same as above.
54240000 hex	Deceleration Setting Out of Range	The parameter specified for the <i>Deceleration</i> input variable to a motion control instruction is out of range.	<ul style="list-style-type: none"> Instruction input parameter exceeded the valid range of the input variable. 			√			Same as above.
54250000 hex	Jerk Setting Out of Range	The parameter specified for the <i>Jerk</i> input variable to a motion control instruction is out of range.	<ul style="list-style-type: none"> Instruction input parameter exceeded the valid range of the input variable. 			√			Same as above.
54270000 hex	Torque Ramp Setting Out of Range	The parameter specified for the <i>TorqueRamp</i> input variable to a motion control instruction is out of range.	<ul style="list-style-type: none"> Instruction input parameter exceeded the valid range of the input variable. 			√			Same as above.

Event code	Event name	Meaning	Assumed cause	Level					Reference
				Maj	Prt	Min	Obs	Info	
54280000 hex	Master Coefficient Scaling Out of Range	The parameter specified for the <i>MasterScaling</i> input variable to a motion control instruction is out of range.	<ul style="list-style-type: none"> Instruction input parameter exceeded the valid range of the input variable. 			√			NJ-series Motion Control Instructions Reference Manual (Cat. No. W508)
54290000 hex	Slave Coefficient Scaling Out of Range	The parameter specified for the <i>SlaveScaling</i> input variable to a motion control instruction is out of range.	<ul style="list-style-type: none"> Instruction input parameter exceeded the valid range of the input variable. 			√			Same as above.
542A0000 hex	Feeding Velocity Setting Out of Range	The parameter specified for the <i>FeedVelocity</i> input variable to a motion control instruction is out of range.	<ul style="list-style-type: none"> The Feed Velocity (input variable <i>FeedVelocity</i>) is still at the default (0). 			√			Same as above.
542B0000 hex	Buffer Mode Selection Out of Range	The parameter specified for the <i>BufferMode</i> input variable to a motion control instruction is out of range.	<ul style="list-style-type: none"> Instruction input parameter exceeded the valid range of the input variable. 			√			Same as above.
542C0000 hex	Coordinate System Selection Out of Range	The parameter specified for the <i>CoordSystem</i> input variable to a motion control instruction is out of range.	<ul style="list-style-type: none"> Instruction input parameter exceeded the valid range of the input variable. 			√			Same as above.
542D0000 hex	Circular Interpolation Mode Selection Out of Range	The parameter specified for the <i>CircMode</i> input variable to a motion control instruction is out of range.	<ul style="list-style-type: none"> Instruction input parameter exceeded the valid range of the input variable. 			√			Same as above.
542E0000 hex	Direction Selection Out of Range	The parameter specified for the <i>Direction</i> input variable to a motion control instruction is out of range.	<ul style="list-style-type: none"> Instruction input parameter exceeded the valid range of the input variable. 			√			Same as above.
542F0000 hex	Path Selection Out of Range	The parameter specified for the <i>PathChoice</i> input variable to a motion control instruction is out of range.	<ul style="list-style-type: none"> Instruction input parameter exceeded the valid range of the input variable. 			√			Same as above.
54300000 hex	Position Type Selection Out of Range	The parameter specified for the <i>ReferenceType</i> input variable to a motion control instruction is out of range.	<ul style="list-style-type: none"> Instruction input parameter exceeded the valid range of the input variable. 			√			Same as above.
54310000 hex	Travel Mode Selection Out of Range	The parameter specified for the <i>MoveMode</i> input variable to a motion control instruction is out of range.	<ul style="list-style-type: none"> Instruction input parameter exceeded the valid range of the input variable. 			√			Same as above.

Event code	Event name	Meaning	Assumed cause	Level					Reference
				Maj	Prt	Min	Obs	Info	
54320000 hex	Transition Mode Selection Out of Range	The parameter specified for the <i>TransitionMode</i> input variable to a motion control instruction is out of range.	<ul style="list-style-type: none"> Instruction input parameter exceeded the valid range of the input variable. <i>_mcAborting</i> or <i>_mcBuffered</i> was specified for <i>BufferMode</i> and <i>_mcTMCornerSuperimpose</i> was specified for <i>TransitionMode</i>. 			√			NJ-series Motion Control Instructions Reference Manual (Cat. No. W508)
54330000 hex	Continue Method Selection Out of Range	The value of the reserved input variable <i>Continuous</i> to a motion control instruction changed.	<ul style="list-style-type: none"> The value of the reserved input variable <i>Continuous</i> changed. 			√			Same as above.
54340000 hex	Combine Mode Selection Out of Range	The parameter specified for the <i>CombineMode</i> input variable to a motion control instruction is out of range.	<ul style="list-style-type: none"> Instruction input parameter exceeded the valid range of the input variable. 			√			Same as above.
54350000 hex	Synchronization Start Condition Selection Out of Range	The parameter specified for the <i>LinkOption</i> input variable to a motion control instruction is out of range.	<ul style="list-style-type: none"> Instruction input parameter exceeded the valid range of the input variable. 			√			Same as above.
54360000 hex	Master and Slave Defined as Same Axis	The same axis is specified for the <i>Master</i> and <i>Slave</i> input variables to a motion control instruction.	<ul style="list-style-type: none"> The parameter is the same for the <i>Master</i> and <i>Slave</i> input variables to the instruction. 			√			Same as above.
54370000 hex	Master and Auxiliary Defined as Same Axis	The same axis is specified for the <i>Master</i> and <i>Auxiliary</i> input variables to a motion control instruction.	<ul style="list-style-type: none"> The parameter is the same for the <i>Master</i> and <i>Auxiliary</i> input variables to the instruction. 			√			Same as above.
54380000 hex	Master/Slave Axis Numbers Not in Ascending Order	The axis numbers specified for the <i>Master</i> and <i>Slave</i> input variables to a motion control instruction are not in ascending order.	<ul style="list-style-type: none"> The parameters for the <i>Master</i> and <i>Slave</i> input variables to the instruction were not in ascending order when <i>_mcLatestCommand</i> was specified for the <i>ReferenceType</i> input variable to the instruction. 			√			Same as above.
54390000 hex	Incorrect Cam Table Specification	The parameter specified for the <i>CamTable</i> input variable to a motion control instruction is out of range.	<ul style="list-style-type: none"> Something other than a cam data variable was specified for the <i>CamTable</i> input variable to the instruction. 			√			Same as above.

Event code	Event name	Meaning	Assumed cause	Level					Reference
				Maj	Prt	Min	Obs	Info	
543A0000 hex	Synchronization Stopped	A synchronized control motion control instruction was executed, but conditions required for execution were not met.	<ul style="list-style-type: none"> The MC_CamOut (End Cam Operation) instruction was executed even though the MC_CamIn (Start Cam Operation) instruction is not being executed. The MC_GearOut (End Gear Operation) instruction was executed even though the MC_GearIn (Start Gear Operation) or the MC_GearInPos (Positioning Gear Operation) instruction is not being executed. The MC_Phasing (Shift Master Axis Phase) instruction was executed even though the MC_CamIn (Start Cam Operation), MC_GearIn (Start Gear Operation), MC_GearInPos (Start Gear Operation), or MC_MoveLink (Synchronous Positioning) instruction is not being executed. 			√			NJ-series Motion Control Instructions Reference Manual (Cat. No. W508)
543B0000 hex	Motion Control Instruction Re-execution Disabled	An attempt was made to re-execute a motion control instruction that cannot be re-executed.	<ul style="list-style-type: none"> A motion control instruction that cannot be re-executed was re-executed. 			√			Same as above.
543C0000 hex	Motion Control Instruction Multi-execution Disabled	Multiple functions that cannot be executed simultaneously were executed for the same target (MC common or axis).	<ul style="list-style-type: none"> Multiple functions that cannot be executed simultaneously were executed for the same target (MC common or axis). 			√			Same as above.
543D0000 hex	Instruction Not Allowed for Encoder Axis Type	An operation instruction was executed for an encoder axis.	<ul style="list-style-type: none"> An operation instruction was executed for an encoder axis. 			√			Same as above.
543E0000 hex	Instruction Cannot Be Executed during Multi-axes Coordinated Control	An operation instruction was executed for an axis or an axes group that was in a coordinated multi-axes motion.	<ul style="list-style-type: none"> An operation instruction was executed for an axis or an axes group that was in a coordinated multi-axes motion. 			√			Same as above.
543F0000 hex	Multi-axes Coordinated Control Instruction Executed for Disabled Axes Group	A multi-axes coordinated control instruction was executed for an axes group that was in the Axes Group Disabled state.	<ul style="list-style-type: none"> A multi-axes coordinated control instruction was executed for an axes group that was in the Axes Group Disabled state. 			√			Same as above.

Event code	Event name	Meaning	Assumed cause	Level					Reference
				Maj	Prt	Min	Obs	Info	
54400000 hex	Axes Group Cannot Be Enabled	Execution of the MC_GroupEnable (Enable Axes Group) instruction failed.	<ul style="list-style-type: none"> When the MC_GroupEnable (Enable Axes Group) instruction was executed, there was a composition axis that was not stopped. When the MC_GroupEnable (Enable Axes Group) instruction was executed, there was a composition axis for which the MC_TouchProbe (Enable External Latch) instruction was being executed. 			√			NJ-series Motion Control Instructions Reference Manual (Cat. No. W508)
54410000 hex	Impossible Axis Operation Specified when the Servo is OFF	An operation instruction was executed for an axis for which the Servo is OFF.	<ul style="list-style-type: none"> An operation instruction was executed for an axis for which the Servo is OFF. Home was preset with the MC_Home instruction for an axis for which EtherCAT process data communications are not established. 			√			Same as above.
54420000 hex	Composition Axis Stopped Error	A motion instruction was executed for an axes group while the MC_Stop instruction was being executed for a composition axis.	<ul style="list-style-type: none"> A motion instruction was executed for an axes group while the MC_Stop instruction was being executed for a composition axis. 			√			Same as above.
54430000 hex	Motion Control Instruction Multi-execution Buffer Limit Exceeded	The number of motion control instructions that is buffered for Buffered or Blending Buffer Modes exceeded the buffer limit.	<ul style="list-style-type: none"> An axis instruction was executed when there was already a current instruction and a buffered instruction for the same axis. An axes group instruction was executed when there was already eight current instructions and buffered instructions for the same axis. 			√			Same as above.
54440000 hex	Insufficient Travel Distance	The specified motion cannot be executed for the deceleration rate or acceleration rate that was specified for multi-execution or re-execution of a positioning instruction.	<ul style="list-style-type: none"> Stopping at the target position was not possible for the specified acceleration/deceleration rate for multi-execution or re-execution of a positioning instruction when the Acceleration/Deceleration Over parameter was set to generate a minor fault and stop. 			√			Same as above.
54450000 hex	Insufficient Travel Distance to Achieve Blending Transit Velocity	There is not sufficient travel distance to accelerate or decelerate to the transit velocity.	<ul style="list-style-type: none"> There was not sufficient travel distance to accelerate the current command to the transit velocity when the Acceleration/Deceleration Over parameter was set to generate a minor fault and stop. 			√			Same as above.
54460000 hex	Move Link Constant Velocity Insufficient Travel Distance	The constant-velocity travel distance of the master axis is less than zero.	<ul style="list-style-type: none"> The constant velocity travel distance of the master axis is below 0 for the MC_MoveLink (Synchronous Positioning) instruction. 			√			Same as above.

Event code	Event name	Meaning	Assumed cause	Level					Reference
				Maj	Prt	Min	Obs	Info	
54470000 hex	Positioning Gear Operation Insufficient Target Velocity	For the MC_GearInPos (Positioning Gear Operation) instruction, the target velocity of the slave axis is too small to achieve the required velocity.	<ul style="list-style-type: none"> For the MC_GearInPos (Positioning Gear Operation) instruction, the value of the <i>Velocity</i> (Target Velocity) input variable is smaller than the master axis velocity multiplied by the gear ratio when the instruction was executed. 			√			NJ-series Motion Control Instructions Reference Manual (Cat. No. W508)
54480000 hex	Same Start Point and End Point for Circular Interpolation	The start point and end point were the same when the radius method was specified for the MC_MoveCircular2D (Circular 2D Interpolation) instruction. Or, the start point, end point, and border point were the same when the border point method was specified.	<ul style="list-style-type: none"> The start point and end point were the same when the radius method was specified for the MC_MoveCircular2D (Circular 2D Interpolation) instruction. The start point, end point, and border point were the same when the border point method was specified for the MC_MoveCircular2D (Circular 2D Interpolation) instruction. 			√			Same as above.
54490000 hex	Circular Interpolation Center Specification Position Out of Range	The position specified for the center point exceeded the allowed range when the center method was specified for the MC_MoveCircular2D (Circular 2D Interpolation) instruction.	<ul style="list-style-type: none"> The difference between the distance from the start point to the center point and the distance between the end point to the center point exceeded the permitted value specified for the correction allowance ratio in the axes group settings when the center designation method was specified for the MC_MoveCircular2D (Circular 2D Interpolation) instruction. 			√			Same as above.
544A0000 hex	Instruction Execution Error Caused by Count Mode Setting	An instruction that cannot be used when the Count Mode is set to Rotary Mode was executed for an axis that was set to Rotary Mode.	<ul style="list-style-type: none"> An instruction that cannot be used when the Count Mode is set to Rotary Mode was executed for an axis that was set to Rotary Mode. 			√			Same as above.
544C0000 hex	Parameter Selection Out of Range	The parameter specified for the <i>ParameterNumber</i> input variable to a motion control instruction is out of range.	<ul style="list-style-type: none"> Instruction input parameter exceeded the valid range of the input variable. 			√			Same as above.
544D0000 hex	Stop Method Selection Out of Range	The parameter specified for the <i>StopMode</i> input variable to a motion control instruction is out of range.	<ul style="list-style-type: none"> Instruction input parameter exceeded the valid range of the input variable. 			√			Same as above.
544E0000 hex	Latch ID Selection Out of Range for Trigger Input Condition	The parameter specified for the <i>TriggerInput::LatchID</i> input variable to a motion control instruction is out of range.	<ul style="list-style-type: none"> Instruction input parameter exceeded the valid range of the input variable. 			√			Same as above.

Event code	Event name	Meaning	Assumed cause	Level					Reference
				Maj	Prt	Min	Obs	Info	
544F0000 hex	Setting Out of Range for Writing MC Setting	The parameter specified for the <i>SettingValue</i> input variable to a motion control instruction is out of range.	<ul style="list-style-type: none"> Instruction input parameter exceeded the valid range of the input variable. The parameter specification and the data type of the setting value do not agree. 			√			NJ-series Motion Control Instructions Reference Manual (Cat. No. W508)
54500000 hex	Trigger Input Condition Mode Selection Out of Range	The parameter specified for the <i>TriggerInput::Mode</i> input variable to a motion control instruction is out of range.	<ul style="list-style-type: none"> Instruction input parameter exceeded the valid range of the input variable. 			√			Same as above.
54510000 hex	Drive Trigger Signal Selection Out of Range for Trigger Input Condition	The parameter specified for the <i>TriggerInput::InputDrive</i> input variable to a motion control instruction is out of range.	<ul style="list-style-type: none"> Instruction input parameter exceeded the valid range of the input variable. 			√			Same as above.
54530000 hex	Motion Control Instruction Re-execution Disabled (Axis Specification)	An attempt was made to change the parameter for the <i>Axis</i> input variable when re-executing a motion control instruction. (This input variable cannot be changed when re-executing an instruction.)	<ul style="list-style-type: none"> A parameter for an input variable that cannot be changed for re-execution was changed. 			√			Same as above.
54540000 hex	Motion Control Instruction Re-execution Disabled (Buffer Mode Selection)	An attempt was made to change the parameter for the <i>BufferMode</i> input variable when re-executing a motion control instruction. (This input variable cannot be changed when re-executing an instruction.)	<ul style="list-style-type: none"> A parameter for an input variable that cannot be changed for re-execution was changed. 			√			Same as above.
54550000 hex	Motion Control Instruction Re-execution Disabled (Direction Selection)	An attempt was made to change the parameter for the <i>Direction</i> input variable when re-executing a motion control instruction. (This input variable cannot be changed when re-executing an instruction.)	<ul style="list-style-type: none"> An input variable that cannot be changed for re-execution was changed. 			√			Same as above.

Event code	Event name	Meaning	Assumed cause	Level					Reference
				Maj	Prt	Min	Obs	Info	
54560000 hex	Motion Control Instruction Re-execution Disabled (Execution Mode)	An attempt was made to change the parameter for the <i>ExecutionMode</i> input variable when re-executing a motion control instruction. (This input variable cannot be changed when re-executing an instruction.)	<ul style="list-style-type: none"> A parameter for an input variable that cannot be changed for re-execution was changed. 			√			NJ-series Motion Control Instructions Reference Manual (Cat. No. W508)
54570000 hex	Motion Control Instruction Re-execution Disabled (Axes Group Specification)	An attempt was made to change the parameter for the <i>AxesGroup</i> input variable when re-executing a motion control instruction. (This input variable cannot be changed when re-executing an instruction.)	<ul style="list-style-type: none"> A parameter for an input variable that cannot be changed for re-execution was changed. 			√			Same as above.
54580000 hex	Motion Control Instruction Re-execution Disabled (Jerk Setting)	An attempt was made to change the parameter for the <i>Jerk</i> input variable when re-executing a motion control instruction. (This input variable cannot be changed when re-executing an instruction.)	<ul style="list-style-type: none"> A parameter for an input variable that cannot be changed for re-execution was changed. 			√			Same as above.
54590000 hex	Motion Control Instruction Re-execution Disabled (Master Axis)	An attempt was made to change the parameter for the <i>Master</i> input variable when re-executing a motion control instruction. (This input variable cannot be changed when re-executing an instruction.)	<ul style="list-style-type: none"> A parameter for an input variable that cannot be changed for re-execution was changed. 			√			Same as above.
545A0000 hex	Motion Control Instruction Re-execution Disabled (MasterOffset)	An attempt was made to change the parameter for the <i>MasterOffset</i> input variable when re-executing a motion control instruction. (This input variable cannot be changed when re-executing an instruction.)	<ul style="list-style-type: none"> A parameter for an input variable that cannot be changed for re-execution was changed. 			√			Same as above.

Event code	Event name	Meaning	Assumed cause	Level					Reference
				Maj	Prt	Min	Obs	Info	
545B0000 hex	Motion Control Instruction Re-execution Disabled (MasterScaling)	An attempt was made to change the parameter for the <i>MasterScaling</i> input variable when re-executing a motion control instruction. (This input variable cannot be changed when re-executing an instruction.)	<ul style="list-style-type: none"> A parameter for an input variable that cannot be changed for re-execution was changed. 			√			NJ-series Motion Control Instructions Reference Manual (Cat. No. W508)
545C0000 hex	Motion Control Instruction Re-execution Disabled (MasterStartDistance)	An attempt was made to change the parameter for the <i>MasterStartDistance</i> input variable when re-executing a motion control instruction. (This input variable cannot be changed when re-executing an instruction.)	<ul style="list-style-type: none"> A parameter for an input variable that cannot be changed for re-execution was changed. 			√			Same as above.
545D0000 hex	Motion Control Instruction Re-execution Disabled (Continuous)	An attempt was made to change the parameter for the <i>Continuous</i> input variable when re-executing a motion control instruction. (This input variable cannot be changed when re-executing an instruction.)	<ul style="list-style-type: none"> A parameter for an input variable that cannot be changed for re-execution was changed. 			√			Same as above.
545E0000 hex	Motion Control Instruction Re-execution Disabled (MoveMode)	An attempt was made to change the parameter for the <i>MoveMode</i> input variable when re-executing a motion control instruction. (This input variable cannot be changed when re-executing an instruction.)	<ul style="list-style-type: none"> A parameter for an input variable that cannot be changed for re-execution was changed. 			√			Same as above.
545F0000 hex	Illegal Auxiliary Axis Specification	The axis specified for the <i>Auxiliary</i> input variable to a motion control instruction does not exist.	<ul style="list-style-type: none"> An axis does not exist for the variable specified for the <i>Auxiliary</i> input variable to the instruction. 			√			Same as above.
54600000 hex	Illegal Axis Specification	The axis specified for the <i>Axis</i> input variable to a motion control instruction does not exist.	<ul style="list-style-type: none"> An axis does not exist for the variable specified for the <i>Axis</i> input variable to the instruction. 			√			Same as above.
54610000 hex	Illegal Axes Group Specification	The axes group specified for the <i>AxesGroup</i> input variable to a motion control instruction does not exist or is not a used group.	<ul style="list-style-type: none"> An axes group does not exist for the variable specified for the <i>AxesGroup</i> input variable to the instruction. The axes group specified for the <i>AxesGroup</i> input variable to the instruction is not specified as a used group. 			√			Same as above.

Event code	Event name	Meaning	Assumed cause	Level					Reference
				Maj	Prt	Min	Obs	Info	
54620000 hex	Illegal Master Axis Specification	The axis specified for the <i>Master</i> input variable to a motion control instruction does not exist or is not a sync master axis.	<ul style="list-style-type: none"> An axis does not exist for the variable specified for the <i>Master</i> input variable to the instruction. The axis that was specified for the <i>Master</i> input variable to the <i>MC_Phasing</i> (Shift Master Axis Phase) instruction is not the master axis for syncing. 			√			NJ-series Motion Control Instructions Reference Manual (Cat. No. W508)
54630000 hex	Motion Control Instruction Re-execution Disabled (SlaveOffset)	An attempt was made to change the <i>SlaveOffset</i> input variable when re-executing a motion control instruction. (This input variable cannot be changed when re-executing an instruction.)	<ul style="list-style-type: none"> A parameter for an input variable that cannot be changed for re-execution was changed. 			√			Same as above.
54640000 hex	Motion Control Instruction Re-execution Disabled (SlaveScaling)	An attempt was made to change the <i>SlaveScaling</i> input variable when re-executing a motion control instruction. (This input variable cannot be changed when re-executing an instruction.)	<ul style="list-style-type: none"> A parameter for an input variable that cannot be changed for re-execution was changed. 			√			Same as above.
54650000 hex	Motion Control Instruction Re-execution Disabled (StartPosition)	An attempt was made to change the <i>StartPosition</i> input variable when re-executing a motion control instruction. (This input variable cannot be changed when re-executing an instruction.)	<ul style="list-style-type: none"> A parameter for an input variable that cannot be changed for re-execution was changed. 			√			Same as above.
54660000 hex	Instruction Execution Error with Undefined Home	High-speed homing or an interpolation instruction was executed when home was undefined.	<ul style="list-style-type: none"> High-speed homing was executed when home was undefined. An interpolation instruction was executed for an axes group that includes an axis with no defined home. 			√			Same as above.
54670000 hex	Motion Control Instruction Re-execution Disabled (Position Type)	An attempt was made to change the <i>ReferenceType</i> input variable when re-executing a motion control instruction. (This input variable cannot be changed when re-executing an instruction.)	<ul style="list-style-type: none"> A parameter for an input variable that cannot be changed for re-execution was changed. 			√			Same as above.
54680000 hex	Unused Axis Specification for Master Axis	The master axis specified for a motion control instruction is an unused axis.	<ul style="list-style-type: none"> The master axis specified for a motion control instruction is an unused axis. 			√			Same as above.

Event code	Event name	Meaning	Assumed cause	Level					Reference
				Maj	Prt	Min	Obs	Info	
54690000 hex	First Position Setting Out of Range	The parameter specified for the <i>FirstPosition</i> input variable to a motion control instruction is out of range.	<ul style="list-style-type: none"> Instruction input parameter exceeded the valid range of the input variable. 			√			NJ-series Motion Control Instructions Reference Manual (Cat. No. W508)
546A0000 hex	Last Position Setting Out of Range	The parameter specified for the <i>LastPosition</i> input variable to a motion control instruction is out of range.	<ul style="list-style-type: none"> Instruction input parameter exceeded the valid range of the input variable. 			√			Same as above.
546B0000 hex	Illegal First/Last Position Size Relationship (Linear Mode)	The parameter specified for the <i>LastPosition</i> input variable to a motion control instruction is smaller than the parameter specified for the <i>FirstPosition</i> input variable.	<ul style="list-style-type: none"> The value of the <i>LastPosition</i> input parameter is less than the value of the <i>FirstPosition</i> input variable for the instruction when the Count Mode is set to Linear Mode. 			√			Same as above.
546C0000 hex	Master Sync Start Position Setting Out of Range	The parameter specified for the <i>MasterSyncPosition</i> input variable to a motion control instruction is out of range.	<ul style="list-style-type: none"> Instruction input parameter exceeded the valid range of the input variable. 			√			Same as above.
546D0000 hex	Slave Sync Start Position Setting Out of Range	The parameter specified for the <i>SlaveSyncPosition</i> input variable to a motion control instruction is out of range.	<ul style="list-style-type: none"> Instruction input parameter exceeded the valid range of the input variable. 			√			Same as above.
546E0000 hex	Duplicate Latch ID for Trigger Input Condition	The same latch ID was specified for more than one motion control instruction.	<ul style="list-style-type: none"> The same latch ID is used simultaneously for more than one of the following instructions: MC_TouchProbe (Enable External Latch) instruction, MC_MoveLink (Synchronous Positioning) instruction, and MC_MoveFeed (Interrupt Feeding) instruction. The MC_AbortTrigger (Disable External Latch) instruction was executed to cancel a latch that was used by an instruction other than the MC_TouchProbe (Enable External Latch) instruction. 			√			Same as above.
546F0000 hex	Jerk Override Factor Out of Range	The parameter specified for the <i>JerkFactor</i> input variable to a motion control instruction is out of range.	<ul style="list-style-type: none"> Instruction input parameter exceeded the valid range of the input variable. 			√			Same as above.
54700000 hex	Acceleration/Deceleration Override Factor Out of Range	The parameter specified for the <i>AccFactor</i> input variable to a motion control instruction is out of range.	<ul style="list-style-type: none"> Instruction input parameter exceeded the valid range of the input variable. 			√			Same as above.

Event code	Event name	Meaning	Assumed cause	Level					Reference
				Maj	Prt	Min	Obs	Info	
54710000 hex	First Position Method Specification Out of Range	The parameter specified for the <i>StartMode</i> input variable to a motion control instruction is out of range.	<ul style="list-style-type: none"> Instruction input parameter exceeded the valid range of the input variable. 			√			NJ-series Motion Control Instructions Reference Manual (Cat. No. W508)
54720000 hex	Motion Control Instruction Re-execution Disabled (First Position Method)	An attempt was made to change the <i>StartMode</i> input variable when re-executing a motion control instruction. (This input variable cannot be changed when re-executing an instruction.)	<ul style="list-style-type: none"> A parameter for an input variable that cannot be changed for re-execution was changed. 			√			Same as above.
54740000 hex	Unused Axis Specification for Auxiliary Axis	The axis specified for the <i>Auxiliary</i> input variable to a motion control instruction is an unused axis.	<ul style="list-style-type: none"> The axis specified for the <i>Auxiliary</i> input variable to the instruction is an unused axis. 			√			Same as above.
54750000 hex	Position Gear Value Error	Synchronized motion is not possible for the velocity, acceleration rate, and deceleration rate that were input to a motion control instruction.	<ul style="list-style-type: none"> The specified synchronized motion cannot be performed at the velocity, acceleration rate, or deceleration rate that is input to the instruction. 			√			Same as above.
54760000 hex	Position Gear Master Axis Zero Velocity	The velocity of the master axis was zero when a motion control instruction was started.	<ul style="list-style-type: none"> The velocity of the master axis was 0 when the instruction was started. 			√			Same as above.
54780000 hex	Target Position Setting Out of Range	The parameter specified for the <i>Position</i> input variable to a motion control instruction is out of range.	<ul style="list-style-type: none"> Instruction input parameter exceeded the valid range of the input variable. The target position of a Rotary Mode axis is not within the ring setting range. 			√			Same as above.
54790000 hex	Travel Distance Out of Range	The parameter that was specified for the <i>Distance</i> input variable to a motion control instruction is out of range or the target position with the value of <i>Distance</i> added is out of range.	<ul style="list-style-type: none"> The absolute value of the instruction input parameter exceeded the range of 40-bit data when it is converted to pulses. For a Linear Mode axis, the target position with the travel distance added exceeded signed 40-bit data when the absolute value is converted to pulses. 			√			Same as above.
547A0000 hex	Cam Table Start Point Setting Out of Range	The parameter specified for the <i>StartPosition</i> input variable to a motion control instruction is out of range.	<ul style="list-style-type: none"> Instruction input parameter exceeded the valid range of the input variable. 			√			Same as above.

Event code	Event name	Meaning	Assumed cause	Level					Reference
				Maj	Prt	Min	Obs	Info	
547B0000 hex	Cam Master Axis Following First Position Setting Out of Range	The parameter specified for the <i>MasterStartDistance</i> input variable to a motion control instruction is out of range.	<ul style="list-style-type: none"> Instruction input parameter exceeded the valid range of the input variable. 			√			NJ-series Motion Control Instructions Reference Manual (Cat. No. W508)
547C0000 hex	Circular Interpolation Radius Setting Error	It was not possible to create a circular path for the specified radius when the radius method was specified for the MC_MoveCircular2D (Circular 2D Interpolation) instruction.	<ul style="list-style-type: none"> For the MC_MoveCircular2D (Circular 2D Interpolation) instruction, it was not possible to create a circular path for the specified radius when the radius method was specified for circular interpolation. 			√			Same as above.
547D0000 hex	Circular Interpolation Radius Overflow	For the MC_MoveCircular2D (Circular 2D Interpolation) instruction, the radius of the circle exceeded the maximum value for the border point or center specification method.	<ul style="list-style-type: none"> For the MC_MoveCircular2D (Circular 2D Interpolation) instruction, the radius of the circle exceeded 40-bit data when converted to pulses for the border point or center specification method. 			√			Same as above.
547E0000 hex	Circular Interpolation Setting Out of Range	The parameter specified for the <i>CircAxes</i> input variable to a motion control instruction is out of range.	<ul style="list-style-type: none"> Instruction input parameter exceeded the valid range of the input variable. The axes that were specified in <i>CircAxes</i> are not included in the composition axes in the Axes Group Settings. The same axis was specified for both axes of <i>CircAxes</i>. 			√			Same as above.
547F0000 hex	Auxiliary/Slave Axis Numbers Not in Ascending Order	The values of the parameters for the <i>Auxiliary</i> and <i>Slave</i> input variables to a motion control instruction are not in ascending order.	<ul style="list-style-type: none"> The parameters for the <i>Auxiliary</i> and <i>Slave</i> input variables to the instruction are not in ascending order. 			√			Same as above.
54800000 hex	Cam Table Property Ascending Data Error at Update	A phase that was not in ascending order was found during calculating the number of valid data. Or, after calculations, the number of valid data is 0.	<ul style="list-style-type: none"> A phase that was not in ascending order was found when calculating the number of valid data. After calculations, the number of valid data is 0. 			√			Same as above.
54810000 hex	MC_Write Target Out of Range	The parameter specified for the <i>Target</i> input variable to a motion control instruction is out of range.	<ul style="list-style-type: none"> Instruction input parameter exceeded the valid range of the input variable. 			√			Same as above.

Event code	Event name	Meaning	Assumed cause	Level					Reference
				Maj	Prt	Min	Obs	Info	
54820000 hex	Master Travel Distance Specification Out of Range	The parameter specified for the <i>MasterDistance</i> input variable to a motion control instruction is out of range.	<ul style="list-style-type: none"> Instruction input parameter exceeded the valid range of the input variable. 			√			NJ-series Motion Control Instructions Reference Manual (Cat. No. W508)
54830000 hex	Master Distance in Acceleration Specification Out of Range	The parameter specified for the <i>MasterDistance-ACC</i> input variable to a motion control instruction is out of range.	<ul style="list-style-type: none"> Instruction input parameter exceeded the valid range of the input variable. 			√			Same as above.
54840000 hex	Master Distance in Deceleration Specification Out of Range	The parameter specified for the <i>MasterDistance-DEC</i> input variable to a motion control instruction is out of range.	<ul style="list-style-type: none"> Instruction input parameter exceeded the valid range of the input variable. 			√			Same as above.
54870000 hex	Execution Mode Selection Out of Range	The parameter specified for the <i>ExecutionMode</i> input variable to a motion control instruction is out of range.	<ul style="list-style-type: none"> Instruction input parameter exceeded the valid range of the input variable. 			√			Same as above.
54880000 hex	Permitted Following Error Out of Range	The parameter specified for the <i>PermittedDeviation</i> input variable to a motion control instruction is out of range.	<ul style="list-style-type: none"> Instruction input parameter exceeded the valid range of the input variable. 			√			Same as above.
54890000 hex	Border Point/Center Position/Radius Specification Out of Range	The parameter specified for the <i>AuxPoint</i> input variable to a motion control instruction is out of range.	<ul style="list-style-type: none"> The value of <i>AuxPoint</i> exceeded signed 40-bit data when converted to pulses for the border point or center specification method. For a radius specifications, the absolute value of <i>AuxPoint[0]</i> exceeded 40-bit data when converted to pulses. 			√			Same as above.
548A0000 hex	End Point Specification Out of Range	The parameter specified for the <i>EndPoint</i> input variable to a motion control instruction is out of range.	<ul style="list-style-type: none"> The instruction input parameter exceeded the range of signed 40-bit data when it is converted to pulses. 			√			Same as above.
548B0000 hex	Slave Travel Distance Specification Out of Range	The parameter specified for the <i>SlaveDistance</i> input variable to a motion control instruction is out of range.	<ul style="list-style-type: none"> The instruction input parameter exceeded the range of 40-bit data when it is converted to pulses. 			√			Same as above.
548C0000 hex	Phase Shift Amount Out of Range	The parameter specified for the <i>PhaseShift</i> input variable to a motion control instruction is out of range.	<ul style="list-style-type: none"> The absolute value of the instruction input parameter exceeded the range of 40-bit data when it is converted to pulses. 			√			Same as above.

Event code	Event name	Meaning	Assumed cause	Level					Reference
				Maj	Prt	Min	Obs	Info	
548D0000 hex	Feeding Distance Out of Range	The parameter specified for the <i>FeedDistance</i> input variable to a motion control instruction is out of range.	<ul style="list-style-type: none"> The absolute value of the instruction input parameter exceeded the range of 40-bit data when it is converted to pulses. 			√			NJ-series Motion Control Instructions Reference Manual (Cat. No. W508)
548E0000 hex	Auxiliary and Slave Defined as Same Axis	The same axis was specified for the <i>Auxiliary</i> and <i>Slave</i> input variables to a motion control instruction.	<ul style="list-style-type: none"> The parameter is the same for the <i>Auxiliary</i> and <i>Slave</i> input variables to the instruction. 			√			Same as above.
548F0000 hex	Relative Position Selection Out of Range	The parameter specified for the <i>Relative</i> input variable to a motion control instruction is out of range.	<ul style="list-style-type: none"> Instruction input parameter exceeded the valid range of the input variable. 			√			Same as above.
54900000 hex	Cam Transition Specification Out of Range	The parameter specified for the <i>CamTransition</i> input variable to a motion control instruction is out of range.	<ul style="list-style-type: none"> Instruction input parameter exceeded the valid range of the input variable. 			√			Same as above.
54910000 hex	Synchronized Control End Mode Selection Out of Range	The parameter specified for the <i>OutMode</i> input variable to a motion control instruction is out of range.	<ul style="list-style-type: none"> Instruction input parameter exceeded the valid range of the input variable. 			√			Same as above.
54920000 hex	Enable External Latch Instruction Execution Disabled	<i>_mclImmediateStop</i> was specified for the <i>StopMode</i> input variable when the <i>MC_TouchProbe</i> (Enable External Latch) instruction was executed in Drive Mode, but the Control Mode was not CSP Mode.	<ul style="list-style-type: none"> <i>_mclImmediateStop</i> was specified for the <i>StopMode</i> input variable when the <i>MC_TouchProbe</i> (Enable External Latch) instruction was executed in Drive Mode, but the Control Mode was not CSP Mode or the Servo was OFF. 			√			Same as above.
54930000 hex	Master Axis Offset Out of Range	The parameter specified for the <i>MasterOffset</i> input variable to a motion control instruction is out of range.	<ul style="list-style-type: none"> The instruction input parameter exceeded the range of signed 40-bit data when it is converted to pulses. 			√			Same as above.
54940000 hex	Slave Axis Offset Out of Range	The parameter specified for the <i>SlaveOffset</i> input variable to a motion control instruction is out of range.	<ul style="list-style-type: none"> The instruction input parameter exceeded the range of signed 40-bit data when it is converted to pulses. 			√			Same as above.
54950000 hex	Command Current Position Count Selection Out of Range	The parameter specified for the <i>CmdPosMode</i> input variable to a motion control instruction is out of range.	<ul style="list-style-type: none"> Instruction input parameter exceeded the valid range of the input variable. 			√			Same as above.

Event code	Event name	Meaning	Assumed cause	Level					Reference
				Maj	Prt	Min	Obs	Info	
54960000 hex	Master Axis Gear Ratio Numerator Out of Range	The parameter specified for the <i>RatioNumerator-Master</i> input variable to a motion control instruction is out of range.	<ul style="list-style-type: none"> Instruction input parameter exceeded the valid range of the input variable. 			√			NJ-series Motion Control Instructions Reference Manual (Cat. No. W508)
54970000 hex	Master Axis Gear Ratio Denominator Out of Range	The parameter specified for the <i>RatioDenominator-Master</i> input variable to a motion control instruction is out of range.	<ul style="list-style-type: none"> Instruction input parameter exceeded the valid range of the input variable. 			√			Same as above.
54980000 hex	Auxiliary Axis Gear Ratio Numerator Out of Range	The parameter specified for the <i>RatioNumeratorAuxiliary</i> input variable to a motion control instruction is out of range.	<ul style="list-style-type: none"> Instruction input parameter exceeded the valid range of the input variable. 			√			Same as above.
54990000 hex	Auxiliary Axis Gear Ratio Denominator Out of Range	The parameter specified for the <i>RatioDenominatorAuxiliary</i> input variable to a motion control instruction is out of range.	<ul style="list-style-type: none"> Instruction input parameter exceeded the valid range of the input variable. 			√			Same as above.
549A0000 hex	Master Axis Position Type Selection Out of Range	The parameter specified for the <i>ReferenceType-Master</i> input variable to a motion control instruction is out of range.	<ul style="list-style-type: none"> Instruction input parameter exceeded the valid range of the input variable. 			√			Same as above.
549B0000 hex	Auxiliary Axis Position Type Selection Out of Range	The parameter specified for the <i>ReferenceTypeAuxiliary</i> input variable to a motion control instruction is out of range.	<ul style="list-style-type: none"> Instruction input parameter exceeded the valid range of the input variable. 			√			Same as above.
549C0000 hex	Target Position Ring Counter Out of Range	Operation is not possible because the target position is out of range for the ring counter of the executed instruction.	<ul style="list-style-type: none"> High-speed homing was executed when 0 was not included in the ring counter. 			√			Same as above.
549D0000 hex (Ver. 1.01)	Axes Group Composition Axis Setting Out of Range	The parameter specified for the <i>Axes</i> input variable to a motion control instruction is out of range.	<ul style="list-style-type: none"> Instruction input parameter exceeded the valid range of the input variable. 			√			Same as above.

Event code	Event name	Meaning	Assumed cause	Level					Reference
				Maj	Prt	Min	Obs	Info	
64400000 hex	Target Position Positive Software Limit Exceeded	The specified position exceeds the positive software limit.	<ul style="list-style-type: none"> The parameter specified for the <i>Position</i> input variable to the instruction is beyond the positive software limit. The first position is beyond the positive software limit and an instruction that specifies motion in the opposite direction of the software limit was executed. The parameter that was specified for the <i>AuxPoint</i> input variable to a border point MC_MoveCircular2D (Circular 2D Interpolation) instruction is beyond the positive software limit. 			√			NJ-series Motion Control Instructions Reference Manual (Cat. No. W508)
64410000 hex	Target Position Negative Software Limit Exceeded	The specified position exceeds the negative software limit.	<ul style="list-style-type: none"> The parameter specified for the <i>Position</i> input variable to the instruction is beyond the negative software limit. The first position is beyond the negative software limit and an instruction that specifies motion in the opposite direction of the software limit was executed. The parameter that was specified for the <i>AuxPoint</i> input variable to a border point MC_MoveCircular2D (Circular 2D Interpolation) instruction is beyond the negative software limit. 			√			Same as above.
64420000 hex	Command Position Overflow/Underflow	Positioning, an instruction in the underflow/overflow direction, or an instruction for which the direction is not specified was executed when there was an underflow/overflow in the command position.	<ul style="list-style-type: none"> One of the following was executed when there was a command position overflow/underflow. <ul style="list-style-type: none"> A positioning instruction A continuous control instruction in the underflow/overflow direction An instruction for which the direction is not specified (syncing or torque control) 			√			Same as above.

Event code	Event name	Meaning	Assumed cause	Level					Reference
				Maj	Prt	Min	Obs	Info	
64430000 hex	Positive Limit Input	An instruction was executed for a motion in the positive direction when the positive limit input was ON.	<ul style="list-style-type: none"> An instruction for a motion in the positive direction was executed when the positive limit input was ON, or an instruction for a motion with no direction specification was executed when the positive limit input was ON. 			√			NJ-series Motion Control Instructions Reference Manual (Cat. No. W508)
64440000 hex	Negative Limit Input	An instruction for a motion in the negative direction was executed when the negative limit input was ON.	<ul style="list-style-type: none"> An instruction for a motion in the negative direction was executed when the negative limit input was ON, or an instruction for a motion with no direction specification was executed when the negative limit input was ON. 			√			Same as above.
74220000 hex	Servo Main Circuits OFF	An attempt was made to turn ON the Servo when the main circuit power supply to the Servo Drive was OFF.	<ul style="list-style-type: none"> An attempt was made to turn ON the Servo when the main circuit power supply to the Servo Drive was OFF. 			√			Same as above.

3-1-4 Errors in the EtherNet/IP Function Module

Built-in EtherNet/IP Port on CPU Unit

Event code	Event name	Meaning	Assumed cause	Level					Reference
				Maj	Prt	Min	Obs	Info	
10200000 hex	User Program/Controller Configurations and Setup Transfer Error	The user program or Controller Configurations and Setup were not transferred correctly.	<ul style="list-style-type: none"> The program is illegal because the power supply to the Controller was interrupted or communications with the Sysmac Studio were disconnected during a transfer of the user program or the Controller Configurations and Setup. The program is illegal because the power supply to the Controller was interrupted or communications with the Sysmac Studio were disconnected during online editing. 	√					NJ-series CPU Unit Built-in EtherNet/IP Port User's Manual (Cat. No. W506)
04200000 hex	Communications Controller Failure	A hardware error was detected in the communications controller of the built-in EtherNet/IP port.	<ul style="list-style-type: none"> Communications Controller hardware error 		√				Same as above.
14200000 hex	MAC Address Error	The MAC address in non-volatile memory was not read correctly.	<ul style="list-style-type: none"> Non-volatile memory failure 		√				Same as above.
14220000 hex	EtherNet/IP Processing Error	A fatal error was detected in the EtherNet/IP Function Module.	<ul style="list-style-type: none"> Hardware has failed. 		√				Same as above.
34210000 hex	Basic Ethernet Setting Error	An error was detected in the Ethernet settings.	<ul style="list-style-type: none"> Power was interrupted when a download was in progress for the Ethernet basic settings. Memory error 		√				Same as above.
34220000 hex	TCP/IP Basic Setting Error (Local Port IP Address)	An error was detected in the IP address settings.	<ul style="list-style-type: none"> Power was interrupted when a download was in progress for the TCP/IP basic settings. Memory error The IP address acquired from BOOTP server is illegal. 		√				Same as above.
84010000 hex	IP Address Duplication Error	The same IP address is used more than once.	<ul style="list-style-type: none"> The IP address of the built-in EtherNet/IP port is also used as the IP address of another node. 		√				Same as above.
84020000 hex	BOOTP Server Connection Error	Connection with the BOOTP server failed.	<ul style="list-style-type: none"> Server is down. An error occurred in the communications path. The IP address acquired from BOOTP server is illegal. 		√				Same as above.
14210000 hex	Identity Error	The CIP identity information in non-volatile memory was not read correctly.	<ul style="list-style-type: none"> Non-volatile memory failure 			√			Same as above.

Event code	Event name	Meaning	Assumed cause	Level					Reference
				Maj	Prt	Min	Obs	Info	
34200000 hex	Tag Data Link Setting Error	An error was detected in the communications settings for tag data links.	<ul style="list-style-type: none"> Power was interrupted when a download was in progress for the data link settings. Memory error 			√			NJ-series CPU Unit Built-in Ether-Net/IP Port User's Manual (Cat. No. W506)
34230000 hex	TCP/IP Advanced Setting Error (IP Router Table)	An error was detected in the hosts in the IP router table.	<ul style="list-style-type: none"> Power was interrupted when a download was in progress for the TCP/IP advanced settings. Memory error There is a mistake in the IP router table settings or hosts settings. 			√			Same as above.
34240000 hex	FTP Server Setting Error	An error was detected in the FTP server settings.	<ul style="list-style-type: none"> Power was interrupted when a download was in progress for the FTP server settings. Memory error 			√			Same as above.
34250000 hex	NTP Client Setting Error	An error was detected in the NTP client settings.	<ul style="list-style-type: none"> Power was interrupted when a download was in progress for the NTP client settings. Memory error 			√			Same as above.
34260000 hex	SNMP Setting Error	An error was detected in the SNMP agent/trap settings.	<ul style="list-style-type: none"> Power was interrupted when a download was in progress for the SNMP agent/trap settings. Memory error 			√			Same as above.
34270000 hex	Tag Name Resolution Error	Resolution of a tag used in a tag data link failed.	<ul style="list-style-type: none"> The size of the network-published variable is different from the tag settings. The I/O direction set for a tag data link and the I/O direction of the Controller variable do not match. There are no network-published variables for the Controller tag settings. A variable in the Controller that is set for a tag data link has the Network Publish attribute set to Input but also has the Constant attribute. 			√			Same as above.
84030000 hex	DNS Server Connection Error	Connection with the DNS server failed.	<ul style="list-style-type: none"> Parameter error Server is down. An error occurred in the communications path. 			√			Same as above.
84040000 hex	NTP Server Connection Error	Connection with the NTP server failed.	<ul style="list-style-type: none"> Parameter error Server is down. An error occurred in the communications path. 			√			Same as above.
84070000 hex	Tag Data Link Connection Failed	Establishing a tag data link connection failed.	<ul style="list-style-type: none"> The tag data link connection information is not the same for the originator and target. Insufficient connections 			√			Same as above.

Event code	Event name	Meaning	Assumed cause	Level					Reference
				Maj	Prt	Min	Obs	Info	
84080000 hex	Tag Data Link Timeout	A timeout occurred in a tag data link.	<ul style="list-style-type: none"> The power supply to the target node is OFF. Communications with the target node stop. The Ethernet cable for EtherNet/IP is disconnected. The Ethernet cable for EtherNet/IP is broken. Noise 			√			NJ-series CPU Unit Built-in EtherNet/IP Port User's Manual (Cat. No. W506)
54E00000 hex	Variable Access Error	Accessing a tag variable that is used in a tag data link failed.	<ul style="list-style-type: none"> An out-of-range value was written by an EtherNet/IP tag data link for a variable that specifies SUBRANGE. 				√		Same as above.
84050000 hex	Packet Discarded Due to Full Reception Buffer	A packet was discarded.	<ul style="list-style-type: none"> A network convergence occurred. 				√		Same as above.
84060000 hex	Link OFF Detected	The Ethernet link status turned OFF.	<ul style="list-style-type: none"> An Ethernet cable is broken, disconnected, or loose. The switching hub power supply is turned OFF. Baud rate mismatch. Noise One of the following operations was performed. <ul style="list-style-type: none"> The Identify object was reset. Settings were downloaded from the Network Configurator and EtherNet/IP was restarted. Settings for EtherNet/IP were downloaded from the Sysmac Studio or the Memory All Clear operation was performed. 				√		Same as above.
94010000 hex	Tag Data Link Download Started	Changing the tag data link settings started.	<ul style="list-style-type: none"> Changing the tag data link settings started. 					√	Same as above.
94020000 hex	Tag Data Link Download Finished	Changing the tag data link settings finished.	<ul style="list-style-type: none"> Changing the tag data link settings finished. 					√	Same as above.
94030000 hex	Tag Data Link Stopped	Tag data links were stopped by Network Configurator or manipulation of a system-defined variable. Or, the data link table was downloaded from the Network Configurator again.	<ul style="list-style-type: none"> Tag data links were stopped by Network Configurator or manipulation of a system-defined variable. 					√	Same as above.
94040000 hex	Tag Data Link Started	Tag data links were started by Network Configurator or manipulation of a system-defined variable. Or, the data link table was downloaded from the Network Configurator again.	<ul style="list-style-type: none"> Tag data links were started by Network Configurator or manipulation of a system-defined variable. 					√	Same as above.

Event code	Event name	Meaning	Assumed cause	Level					Reference
				Maj	Prt	Min	Obs	Info	
94050000 hex	Link Detected	Establishment of an Ethernet link was detected.	<ul style="list-style-type: none"> Establishment of an Ethernet link was detected. 					√	NJ-series CPU Unit Built-in Ethernet/IP Port User's Manual (Cat. No. W506)
94060000 hex	Restarting Ethernet Port	The built-in Ethernet/IP port was restarted.	<ul style="list-style-type: none"> The built-in Ethernet/IP port was restarted. 					√	Same as above.
94070000 hex	Tag Data Link All Run	Tag data link connections to all nodes have been established.	<ul style="list-style-type: none"> Tag data link connections to all target nodes have been established. 					√	Same as above.
94080000 hex	IP Address Fixed	The correct IP address has been determined and Ethernet communications can start.	<ul style="list-style-type: none"> The correct IP address has been determined and Ethernet communications can start. 					√	Same as above.
94090000 hex	BOOTP Client Started	The BOOTP client started requesting an IP address.	<ul style="list-style-type: none"> The BOOTP client started requesting an IP address. 					√	Same as above.
940A0000 hex	FTP Server Started	The FTP agent started normally.	<ul style="list-style-type: none"> The FTP agent started normally. 					√	Same as above.
940B0000 hex	NTP Client Started	The NTP client started normally and a request for the NTP server to obtain the time started.	<ul style="list-style-type: none"> The NTP client started normally and a request for the NTP server to obtain the time started. 					√	Same as above.
940C0000 hex	SNMP Started	The SNMP agent started normally.	<ul style="list-style-type: none"> The SNMP agent started normally. 					√	Same as above.

3-1-5 Errors in the EtherCAT Master Function Module

Built-in EtherCAT Master in CPU Unit

Event code	Event name	Meaning	Assumed cause	Level					Reference
				Maj	Prt	Min	Obs	Info	
10200000 hex	User Program/Controller Configurations and Setup Transfer Error	The user program or Controller Configurations and Setup were not transferred correctly.	<ul style="list-style-type: none"> The user program or Controller Configurations and Setup are not correct because the power supply to the Controller was interrupted or communications with the Sysmac Studio were disconnected during a download of the user program or the Controller Configurations and Setup. The user program or Controller Configurations and Setup are not correct because the power supply to the Controller was interrupted during online editing. The user program or Controller Configurations and Setup are not correct because the power supply to the Controller was interrupted during a Clear All Memory operation. Non-volatile memory failed. 	√					NJ-series CPU Unit Built-in EtherCAT Port User's Manual (Cat. No. W505)
04400000 hex	Communications Controller Failure	An error was detected in the hardware test at startup.	<ul style="list-style-type: none"> The CPU Unit has failed. 		√				Same as above.
14400000 hex	MAC Address Error	The MAC address is incorrect.	<ul style="list-style-type: none"> The CPU Unit has failed. 		√				Same as above.
44010000 hex	EtherCAT Fault	A fatal error was detected in the EtherCAT Master Function Module.	<ul style="list-style-type: none"> Software is corrupted. 		√				Same as above.
24200000 hex	Slave Node Address Duplicated	The same slave address is used for two nodes.	<ul style="list-style-type: none"> The same node address is set for more than one slave. 			√			Same as above.
34400000 hex	Network Configuration Information Error	There is an error in the network configuration information.	<ul style="list-style-type: none"> The power supply to the Controller was interrupted or communications with the Sysmac Studio were disconnected while downloading the network configuration information. 			√			Same as above.
84200000 hex	Link OFF Error	A Link OFF state occurred.	<ul style="list-style-type: none"> The Ethernet cable is broken between the master and slaves. The Ethernet cable connector is disconnected. The Ethernet cable is not connected. 			√			Same as above.

Event code	Event name	Meaning	Assumed cause	Level					Reference
				Maj	Prt	Min	Obs	Info	
84210000 hex	Network Configuration Error	The EtherCAT network configuration is incorrect.	<ul style="list-style-type: none"> Slave output ports are connected to each other. The master and slave are connected with the slave output port. The number of connected slaves exceeded the maximum number of slaves, 192 nodes, for the EtherCAT master. 			√			NJ-series CPU Unit Built-in EtherCAT Port User's Manual (Cat. No. W505)
84220000 hex	Network Configuration Verification Error	A slave that is in the network configuration information is not connected. Or, a slave that is not in the network configuration information is connected.	<ul style="list-style-type: none"> A slave that is in the network configuration information is not connected. There is a node address mismatch. A different slave from the one that is specified in the network configuration information is connected. A slave that is not in the network configuration information is connected. The Ethernet physical layer is broken between two slaves. 			√			Same as above.
84230000 hex	Slave Initialization Error	Slave initialization failed.	<ul style="list-style-type: none"> An error occurred in EtherCAT master processing. An initialization error occurred in the EtherCAT slave. 			√			Same as above.
84280000 hex	Slave Application Error	An error occurred in the slave application.	<ul style="list-style-type: none"> An error was detected in the slave's application layer status register. 			√			Same as above.
84290000 hex	Process Data Transmission Error	Sending process data failed.	<ul style="list-style-type: none"> It was not possible to send the EtherCAT frame during the EtherCAT communications period. The frame transmission jitter exceeded the limit. 			√			Same as above.
842B0000 hex	Process Data Reception Timeout	Process data reception timed out.	<ul style="list-style-type: none"> The Ethernet cable is broken. The Ethernet cable for Ethernet/IP is disconnected. A general-purpose Ethernet hub is connected. The master failed. The slave failed. The Ethernet cable is too long. The CPU Unit task period is too short. Noise 			√			Same as above.
842C0000 hex	Process Data Communications Error	An error occurred in process data communications.	<ul style="list-style-type: none"> A slave left the network even though the disconnection operation was not performed. Noise Moving Slaves 			√			Same as above.
64200000 hex	Emergency Message Detected	An emergency message was detected.	<ul style="list-style-type: none"> An emergency message was received from a slave. 				√		Same as above.
842D0000 hex	EtherCAT Message Error	An error occurred in a message communications with the slave.	<ul style="list-style-type: none"> Refer to the attached information to check the error. 				√		Same as above.

Event code	Event name	Meaning	Assumed cause	Level					Reference
				Maj	Prt	Min	Obs	Info	
94400000 hex	Slave Disconnected	A slave was disconnected for a disconnection command.	<ul style="list-style-type: none"> An operation to disconnect the slave was executed from the Sysmac Studio. The EC_DisconnectSlave instruction was executed. 					√	NJ-series CPU Unit Built-in EtherCAT Port User's Manual (Cat. No. W505)
94410000 hex	Slave Connected	A slave was reconnected for a reconnection command.	<ul style="list-style-type: none"> An operation to reconnect the slave was executed from the Sysmac Studio. The EC_ConnectSlave instruction was executed. 					√	Same as above.
94430000 hex	Errors Reset	A command was received to reset errors.	<ul style="list-style-type: none"> An error reset operation was performed from the Sysmac Studio. The ResetECError instruction was executed. 					√	Same as above.

3-1-6 Errors in EtherCAT Slaves

This section provides tables of the events for which OMRON EtherCAT slaves provide notification to the NJ-series CPU Unit.

- Block I/O (GX-series EtherCAT Slave Units)
- G5-series Servo Drives with Built-in EtherCAT Communications
- MX2-series Inverters with EtherCAT Communications Units
- EtherCAT FQ-M-series Specialized Vision Sensors for Positioning
- E3X-series Fiber Sensors with EtherCAT Communications Unit for Digital Sensors

Block I/O (GX-series EtherCAT Slave Units)

Event code	Event name	Meaning	Assumed cause	Level					Reference
				Maj	Prt	Min	Obs	Info	
14A00000 hex	Non-volatile Memory Checksum Error	An error occurred in the control parameters.	<ul style="list-style-type: none"> • Noise 			√			GX-series EtherCAT Slave Units User's Manual (Cat. No. W488)
24610000 hex	Switch Setting Error	The setting switch is set out of range.	<ul style="list-style-type: none"> • The analog range that is set on the switch is outside the setting range. 			√			Same as above.
64CC0000 hex	I/O Disconnection Detected	An I/O signal line is disconnected.	<ul style="list-style-type: none"> • I/O signal wiring is disconnected or has a faulty connection. • An I/O signal line is disconnected. 			√			Same as above.
04A10000 hex	Non-volatile Memory Hardware Error	An error occurred in non-volatile memory.	<ul style="list-style-type: none"> • Non-volatile memory failure 				√		Same as above.

G5-series Servo Drives with Built-in EtherCAT Communications

Event code	Event name	Meaning	Assumed cause	Level					Reference
				Maj	Prt	Min	Obs	Info	
04A80000 hex	Control Power Supply Undervoltage	The voltage between the positive and negative terminals in the control power supply converter dropped below the specified value.	<ul style="list-style-type: none"> Power supply undervoltage. Or, the power supply voltage dropped because there was inrush current when the main power supply was turned ON. A momentary power interruption occurred. The Servo Drive failed. 			√			AC Servomotors/Servo Drives G5 Series with Built-in EtherCAT Communications User's Manual (Cat. No. I576)
04A90000 hex	Overvoltage	The power supply voltage exceeded the allowable input voltage range.	<ul style="list-style-type: none"> The voltage between the positive and negative terminals in the control power supply converter exceeded the specified value. The voltage was suddenly increased by the phase advance capacitor or the uninterruptible power supply (UPS). The Regeneration Resistor wiring is broken. The External Regeneration Resistor is not suitable. The Servo Drive failed. 			√			Same as above.
04AA0000 hex	Main Circuit Power Supply Undervoltage (Undervoltage between positive and negative terminals)	If the Undervoltage Error Selection (3508 hex) is set to 1, a momentary power interruption occurred between L1 and L3 for longer than the value specified for the Momentary Hold Time. The voltage between the positive and negative terminals in the main power supply converter dropped below the specified value while the Servo was ON.	<ul style="list-style-type: none"> Insufficient power supply capacity The electromagnetic contactor in the main circuit power supply was tripped. A momentary power interruption occurred. A Servo Drive with 3-phase input specifications was operated with a single-phase power supply. The Servo Drive failed. 			√			Same as above.
04AB0000 hex	Main Circuit Power Supply Undervoltage (AC Cutoff Detected)	If the Undervoltage Error Selection (3508 hex) is set to 1, a momentary power interruption occurred between L1 and L3 for longer than the value specified for the Momentary Hold Time. The voltage between the positive and negative terminals in the main power supply converter dropped below the specified value while the Servo was ON.	<ul style="list-style-type: none"> Insufficient power supply capacity The electromagnetic contactor in the main circuit power supply was tripped. A momentary power interruption occurred. A Servo Drive with 3-phase input specifications was operated with a single-phase power supply. The Servo Drive failed. 			√			Same as above.

Event code	Event name	Meaning	Assumed cause	Level					Reference
				Maj	Prt	Min	Obs	Info	
04AC0000 hex	Overcurrent	The current flowing through the converter exceeded the specified value.	<ul style="list-style-type: none"> A short-circuit, line-to-ground fault, contact failure, or insulation failure occurred on the U, V, or W motor line. The Servo Drive failed. The relay for the dynamic brake has been welded due to frequent Servo ON/OFF operations. Motor windings are burned out. The Servomotor is not suitable for the Servo Drive. The command input timing is the same as or earlier than the Servo ON timing. 			√			AC Servomotors/Servo Drives G5 Series with Built-in EtherCAT Communications User's Manual (Cat. No. I576)
04AD0000 hex	IPM Error	The current flowing through the converter exceeded the specified value.	<ul style="list-style-type: none"> A short-circuit, line-to-ground fault, contact failure, or insulation failure occurred on the U, V, or W motor line. The Servo Drive failed. The relay for the dynamic brake has been welded due to frequent Servo ON/OFF operations. Motor windings are burned out. The Servomotor is not suitable for the Servo Drive. The pulse input timing is the same as or earlier than the Servo ON timing. 			√			Same as above.
04AE0000 hex	Regeneration Tr Error	The Servo Drive regeneration drive Tr is faulty.	<ul style="list-style-type: none"> The Servo Drive regeneration drive Tr is faulty. 			√			Same as above.
04AF0000 hex	Encoder Phase-Z Error	A missing serial incremental encoder phase-Z pulse was detected.	<ul style="list-style-type: none"> The encoder is faulty. 			√			Same as above.
04B00000 hex	Encoder CTS Signal Error	A missing serial incremental encoder CTS signal logic error was detected.	<ul style="list-style-type: none"> The encoder is faulty. 			√			Same as above.
04B10000 hex	Node Address Setting Error	The node address that was read from the rotary switches was not between 00 and 99.	<ul style="list-style-type: none"> The Servo Drive failed. 			√			Same as above.
08080000 hex	Encoder Communications Disconnection Error	A disconnection was detected because communications between the encoder and the Servo Drive were stopped more frequently than the specified value.	<ul style="list-style-type: none"> The encoder is not wired correctly. 			√			Same as above.
08090000 hex	Encoder Communications Error	There is a communications error for the encoder.	<ul style="list-style-type: none"> The power supply voltage of the encoder is low. Noise 			√			Same as above.

Event code	Event name	Meaning	Assumed cause	Level					Reference
				Maj	Prt	Min	Obs	Info	
080A0000 hex	Encoder Communications Data Error	There is an error in the communications data of the encoder.	<ul style="list-style-type: none"> The power supply voltage of the encoder is low. Noise 			√			AC Servomotors/Servo Drives G5 Series with Built-in EtherCAT Communications User's Manual (Cat. No. I576)
080B0000 hex	Safety Input Error	At least one of the input photocouplers for safety inputs 1 and 2 turned OFF.	<ul style="list-style-type: none"> The cable is disconnected or broken. 			√			Same as above.
080C0000 hex	External Encoder Connection Error	A disconnection was detected because communications between the external encoder and the Servo Drive were stopped more frequently than the specified value.	<ul style="list-style-type: none"> The wiring is incorrect. 			√			Same as above.
080D0000 hex	External Encoder Communications Data Error	There was a communications error in data from the external encoder.	<ul style="list-style-type: none"> There is insufficient external encoder power supply voltage. Noise 			√			Same as above.
080E0000 hex	External Encoder Status Error 0	Bit 00 of the external encoder error code (ALMC) was set to 1.	<ul style="list-style-type: none"> Bit 00 of the external scale error code (ALMC) was set to 1. 			√			Same as above.
080F0000 hex	External Encoder Status Error 1	Bit 01 of the external encoder error code (ALMC) was set to 1.	<ul style="list-style-type: none"> Bit 01 of the external encoder error code (ALMC) was set to 1. 			√			Same as above.
08100000 hex	External Encoder Status Error 2	Bit 02 of the external encoder error code (ALMC) was set to 1.	<ul style="list-style-type: none"> Bit 02 of the external encoder error code (ALMC) was set to 1. 			√			Same as above.
08110000 hex	External Encoder Status Error 3	Bit 03 of the external encoder error code (ALMC) was set to 1.	<ul style="list-style-type: none"> Bit 03 of the external encoder error code (ALMC) was set to 1. 			√			Same as above.
08120000 hex	External Encoder Status Error 4	Bit 04 of the external encoder error code (ALMC) was set to 1.	<ul style="list-style-type: none"> Bit 04 of the external encoder error code (ALMC) was set to 1. 			√			Same as above.
08130000 hex	External Encoder Status Error 5	Bit 05 of the external encoder error code (ALMC) was set to 1.	<ul style="list-style-type: none"> Bit 05 of the external encoder error code (ALMC) was set to 1. 			√			Same as above.
08140000 hex	Phase-A Connection Error	An error such as broken wiring was detected in the external encoder phase-A connection.	<ul style="list-style-type: none"> An error such as broken wiring was detected in the external encoder phase-A connection. 			√			Same as above.

Event code	Event name	Meaning	Assumed cause	Level					Reference
				Maj	Prt	Min	Obs	Info	
08150000 hex	Phase-B Connection Error	An error such as broken wiring was detected in the external encoder phase-B connection.	<ul style="list-style-type: none"> An error such as broken wiring was detected in the external encoder phase-B connection. 			√			AC Servomotors/Servo Drives G5 Series with Built-in EtherCAT Communications User's Manual (Cat. No. I576)
08160000 hex	Phase-Z Connection Error	An error such as broken wiring was detected in the external encoder phase-Z connection.	<ul style="list-style-type: none"> An error such as broken wiring was detected in the external encoder phase-Z connection. 			√			Same as above.
08170000 hex	Encoder Data Restoration Error	Initialization of internal position data was not processed correctly in Semi-closed Control Mode and Absolute Value Mode.	<ul style="list-style-type: none"> There is insufficient power supply voltage for the encoder. Noise is entering on the encoder line. 			√			Same as above.
08180000 hex	External Encoder Data Restoration Error	Initialization of internal position data was not processed correctly in Fully-closed Control Mode and Absolute Value Mode.	<ul style="list-style-type: none"> There is insufficient power supply voltage for the external encoder. Noise is entering on the external encoder line. 			√			Same as above.
14A80000 hex	Object Error	The object area data in non-volatile memory is corrupted.	<ul style="list-style-type: none"> Noise Non-volatile memory failure 			√			Same as above.
14A90000 hex	Object Error	The object area data in non-volatile memory is corrupted.	<ul style="list-style-type: none"> Noise Non-volatile memory failure 			√			Same as above.
14AA0000 hex	Object Error	The object area data in non-volatile memory is corrupted.	<ul style="list-style-type: none"> Noise Non-volatile memory failure 			√			Same as above.
14AB0000 hex	Object Corrupted	The checksum data in non-volatile memory is corrupted.	<ul style="list-style-type: none"> Non-volatile memory failure 			√			Same as above.
14AC0000 hex	Object Corrupted	The checksum data in non-volatile memory is corrupted.	<ul style="list-style-type: none"> Non-volatile memory failure 			√			Same as above.
14AD0000 hex	Object Corrupted	The checksum data in non-volatile memory is corrupted.	<ul style="list-style-type: none"> Non-volatile memory failure 			√			Same as above.
18200000 hex	Absolute Encoder Overspeed Error	The Servomotor rotation speed exceeded the specified value when only the battery power supply was used during a power interruption.	<ul style="list-style-type: none"> There is insufficient power supply voltage for the encoder. The wiring of the CN2 connector is wrong. An external force is rotating the motor when the Servo is OFF. 			√			Same as above.

Event code	Event name	Meaning	Assumed cause	Level					Reference
				Maj	Prt	Min	Obs	Info	
18210000 hex	Encoder Initialization Error	An encoder initialization error was detected.	<ul style="list-style-type: none"> Servomotor failed. 			√			AC Servomotors/Servo Drives G5 Series with Built-in EtherCAT Communications User's Manual (Cat. No. I576)
18220000 hex	Absolute Encoder One-rotation Counter Error	The encoder detected a one-rotation counter error.	<ul style="list-style-type: none"> Servomotor failed. 			√			Same as above.
18230000 hex	Absolute Encoder Multi-rotation Counter Error	The encoder detected a multi-rotation counter error.	<ul style="list-style-type: none"> Servomotor failed. 			√			Same as above.
24680000 hex	Motor Non-conformity	The Servo Drive and Servomotor combination is not correct.	<ul style="list-style-type: none"> The Servo Drive and Servomotor combination is not correct. 			√			Same as above.
24690000 hex	Motor Non-conformity	The Servo Drive and Servomotor combination is not correct.	<ul style="list-style-type: none"> The Servo Drive and Servomotor combination is not correct. 			√			Same as above.
246A0000 hex	Motor Non-conformity	The Servo Drive and Servomotor combination is not correct.	<ul style="list-style-type: none"> The Servo Drive and Servomotor combination is not correct. 			√			Same as above.
246B0000 hex	Motor Non-conformity	The Servo Drive and Servomotor combination is not correct.	<ul style="list-style-type: none"> The Servo Drive and Servomotor combination is not correct. 			√			Same as above.
246C0000 hex	Motor Non-conformity	The Servo Drive and Servomotor combination is not correct.	<ul style="list-style-type: none"> The Servo Drive and Servomotor combination is not correct. 			√			Same as above.
34E10000 hex	Servo Drive Overheat	The temperature of the Servo Drive radiator or power elements exceeded the specified value.	<ul style="list-style-type: none"> The ambient temperature of the Servo Drive exceeded the specified value. Overload 			√			Same as above.
34E20000 hex	Overload	When the feedback value for torque command exceeds the overload level specified in the Overload Detection Level Setting (3512 hex), overload protection is performed according to the overload characteristics.	<ul style="list-style-type: none"> Operation was continued for a long time while overloaded. There is incorrect wiring of the motor line or a broken cable. 			√			Same as above.

Event code	Event name	Meaning	Assumed cause	Level					Reference
				Maj	Prt	Min	Obs	Info	
34E30000 hex	Regeneration Overload	The regenerative energy exceeds the processing capacity of the Regeneration Resistor.	<ul style="list-style-type: none"> The load inertia is too large. Or, the Servomotor rotation speed is too high to absorb the regenerative energy within the specified deceleration time. This Regeneration Resistor cannot be used for continuous regenerative braking. (The operating limit of the external resistor is limited to a 10% duty.) 			√			AC Servomotors/Servo Drives G5 Series with Built-in EtherCAT Communications User's Manual (Cat. No. I576)
34E40000 hex	Error Counter Overflow	Position error pulses exceeded the setting of the Following error window (6065 hex).	<ul style="list-style-type: none"> Motor operation does not follow the command. The value of the Following error window (6065 hex) is small. The encoder wiring is incorrect. 			√			Same as above.
34E50000 hex	Excessive Velocity Error	The difference between the internal position command velocity and the actual velocity (i.e., the velocity error) exceeded the Excessive Velocity Error Setting (3602 hex).	<ul style="list-style-type: none"> Motor operation does not follow the command. The setting of the Excessive Velocity Error Setting (3602 hex) is too small. 			√			Same as above.
34E60000 hex	Overspeed	The Servomotor rotation speed exceeded the value set on the Overspeed Detection Level Setting (3513 hex).	<ul style="list-style-type: none"> The velocity command value is too large. There is overshooting. The wiring is incorrect. 			√			Same as above.
383F0000 hex	Excessive Hybrid Following Error	During fully-closed control, the difference between the load position from the external encoder and the Servomotor position from the encoder was larger than the number of pulses set as the Hybrid Following Error Counter Overflow Level (3328 hex).	<ul style="list-style-type: none"> Connections are not correct. The settings are not correct. 			√			Same as above.
38400000 hex	Overspeed 2	The Servomotor rotation speed exceeded the value set on Overspeed Detection Level Setting at Immediate Stop (3615 hex).	<ul style="list-style-type: none"> The velocity command value is too large. There is overshooting. The wiring is incorrect. 			√			Same as above.
38410000 hex	Command Error	The position command variation after the electronic gear exceeded the specified value.	<ul style="list-style-type: none"> The change in position command is too large. The backlash compensation amount is too large. 			√			Same as above.

Event code	Event name	Meaning	Assumed cause	Level					Reference
				Maj	Prt	Min	Obs	Info	
38420000 hex	Command Generation Error	During position command processing, an error such as a calculation range error occurred.	<ul style="list-style-type: none"> During position command processing, an error such as a calculation range error occurred. 			√			AC Servomotors/Servo Drives G5 Series with Built-in EtherCAT Communications User's Manual (Cat. No. I576)
38430000 hex	Error Counter Overflow 1	The absolute encoder (absolute scale) position in pulses divided by the electronic gear ratio exceeded $\pm 2^{31}$ (2,147,483,648).	<ul style="list-style-type: none"> The absolute encoder (absolute scale) position in pulses divided by the electronic gear ratio exceeded $\pm 2^{31}$ (2,147,483,648). 			√			Same as above.
38440000 hex	Error Counter Overflow 2	The position following error in pulses exceeded $\pm 2^{29}$ (536,870,912). Or, the position following error in command units exceeded $\pm 2^{30}$ (1,073,741,824).	<ul style="list-style-type: none"> There is insufficient torque. There is insufficient gain. The encoder wiring is incorrect. 			√			Same as above.
38450000 hex	Interface Input Duplicate Allocation Error 1	There is a duplicate setting in the input signal (IN1, IN2, IN3, and IN4) function allocations.	<ul style="list-style-type: none"> There is a duplicate setting in the input signal (IN1, IN2, IN3, and IN4) function allocations. 			√			Same as above.
38460000 hex	Interface Input Duplicate Allocation Error 2	There is a duplicate setting in the input signal (IN5, IN6, IN7, and IN8) function allocations.	<ul style="list-style-type: none"> There is a duplicate setting in the input signal (IN5, IN6, IN7, and IN8) function allocations. 			√			Same as above.
38470000 hex	Interface Input Function Number Error 1	There is an undefined number specification in the input signal (IN1, IN2, IN3, and IN4) function allocations. Or, a logic setting error was detected.	<ul style="list-style-type: none"> There is an undefined number specification in the input signal (IN1, IN2, IN3, and IN4) function allocations. Different logic is set for the same function in the function assignments of the input signals (IN1, IN2, IN3, and IN4). 			√			Same as above.
38480000 hex	Interface Input Function Number Error 2	There is an undefined number specification in the input signal (IN5, IN6, IN7, and IN8) function allocations. Or, a logic setting error was detected.	<ul style="list-style-type: none"> There is an undefined number specification in the input signal (IN5, IN6, IN7, and IN8) function allocations. Different logic is set for the same function in the function assignments of the input signals (IN5, IN6, IN7, and IN8). 			√			Same as above.
38490000 hex	Interface Output Function Number Error 1	There is an undefined number specification in the output signal (OUTM1) function allocation.	<ul style="list-style-type: none"> There is an undefined number specification in the output signal (OUTM1) function allocation. 			√			Same as above.

Event code	Event name	Meaning	Assumed cause	Level					Reference
				Maj	Prt	Min	Obs	Info	
384A0000 hex	Interface Output Function Number Error 2	There is an undefined number specification in the output signal (OUTM2) function allocation.	<ul style="list-style-type: none"> There is an undefined number specification in the output signal (OUTM2) function allocation. 			√			AC Servomotors/Servo Drives G5 Series with Built-in Ether-CAT Communications User's Manual (Cat. No. I576)
384B0000 hex	External Latch Input Allocation Error	There is an error in the latch input function allocation.	<ul style="list-style-type: none"> The latch input was allocated to an input signal other than IN5, IN6, or IN7. A latch input is assigned to an NC signal. The same latch input is not assigned to the same pin in all Control Modes. 			√			Same as above.
384C0000 hex	Overrun Limit Error	The Servomotor exceeded the allowable operating range set in the Overrun Limit Setting (3514 hex) with respect to the position command input range.	<ul style="list-style-type: none"> The gain or inertial ratio is not suitable. The set value of the Overrun Limit Setting (3514 hex) is too small. 			√			Same as above.
384D0000 hex	Absolute Encoder System Down Error	The voltage of the built-in capacitor dropped below the specified value because the power supply to the encoder or the battery power supply was down.	<ul style="list-style-type: none"> The voltage of the built-in capacitor dropped below the specified value because the power supply to the encoder or the battery power supply was down. 			√			Same as above.
384E0000 hex	Absolute Encoder Counter Overflow Error	The multi-rotation counter of the encoder exceeded the specified value.	<ul style="list-style-type: none"> The set value for switching operation with the absolute encoder is too large. The traveling distance from home of the machine exceeded 32,767 revolutions. 			√			Same as above.
384F0000 hex	Object Setting Error 1	The electronic gear ratio exceeded the allowable range.	<ul style="list-style-type: none"> The electronic gear ratio exceeded the allowable range. 			√			Same as above.
38500000 hex	Object Setting Error 2	External encoder ratio exceeded the allowable range.	<ul style="list-style-type: none"> External encoder ratio exceeded the allowable range. 			√			Same as above.
38510000 hex	External Encoder Connection Error	The set value of the External Feedback Pulse Type Selection (3323 hex) differs from the external encoder type that is connected for serial communications.	<ul style="list-style-type: none"> The set value of the External Feedback Pulse Type Selection (3323 hex) differs from the external encoder type that is connected for serial communications. 			√			Same as above.

Event code	Event name	Meaning	Assumed cause	Level					Reference
				Maj	Prt	Min	Obs	Info	
38520000 hex	Function Setting Error	The function that was set does not support the communications period.	<ul style="list-style-type: none"> The electronic gear object ratio was not 1:1 when the communications period was set to 250 or 500 μs. Fully-closed Control Mode was selected for a communications period setting of 250 μs. Modes of operation (6060 hex) was set to pp or hm when the communications period was set to 250 or 500 μs. More than 20 bytes were mapped for RxPDO when the communications period was set to 250 μs. More than 12 bytes were mapped for RxPDO in Fully-closed Control Mode. Modes of operation (6060 hex) was set to pp or hm in Fully-closed Control Mode when the communications period was set to 1 ms and the electronic gear parameter ratio was not set to 1:1. No bytes (i.e., no objects) were mapped for RxPDO. More than 10 objects were mapped for RxPDO. More than 11 objects were mapped for TxPDO. CSP Switching Reference Position (4020 hex) was mapped for TxPDO when the communications period was set to 250 or 500 μs or when the electronic gear object ratio was not set to 1:1. 			√			AC Servomotors/Servo Drives G5 Series with Built-in EtherCAT Communications User's Manual (Cat. No. I576)
64E00000 hex	Drive Prohibition Input Error 1	When the Drive Prohibition Input Selection (3504 hex) was set to 0, both the Forward Drive Prohibition Input (POT) and the Reverse Drive Prohibition Input (NOT) turned ON. Or, when the Drive Prohibition Input Selection (3504 hex) was set to 2, either the Forward Drive Prohibition Input (POT) or the Reverse Drive Prohibition Input (NOT) turned ON.	<ul style="list-style-type: none"> A problem occurred with the switches, wires, and power supplies that are connected to the Forward Drive Prohibition input or the Reverse Drive Prohibition input. 			√			Same as above.

Event code	Event name	Meaning	Assumed cause	Level					Reference
				Maj	Prt	Min	Obs	Info	
64E10000 hex	Drive Prohibition Input Error 2	An operation command (such as a trial run of FFT) was received from the CX-Drive when the Drive Prohibition Input Selection (3504 hex) was set to 0, EtherCAT communications was interrupted, and either POT or NOT was ON. Or, POT or NOT turned ON while operation was being performed for a CX-Drive operation command.	<ul style="list-style-type: none"> A problem occurred with the switches, wires, and power supplies that are connected to the Forward Drive Prohibition input or the Reverse Drive Prohibition input. 			√			AC Servomotors/Servo Drives G5 Series with Built-in EtherCAT Communications User's Manual (Cat. No. I576)
64E20000 hex	Immediate Stop Input Error	An Immediate Stop (STOP) signal was input.	<ul style="list-style-type: none"> An Immediate Stop (STOP) signal was input. Incorrect wiring of the immediate stop input (STOP). 			√			Same as above.
74810000 hex	Command Error	A mistake was made in using a command.	<ul style="list-style-type: none"> When bit 09 (Remote) of the Statusword (6041 hex) was set to 1 (remote), and the Servo Drive was in operation enabled state (Servo ON), a command was received that changes the communications state from Operational to another state (Init, Pre-operational, or Safe-operational state). When bit 09 (Remote) of the Statusword (6041 hex) was set to 0 (local), a command was received during FFT or test run status that changes the ESM state from Operational, Safe-operational, or Pre-operational state to Init state. An unsupported number was set for 6060 hex (Operation Mode). During Fully-closed Control Mode, csv or cst was set for 6060 hex (Operation Mode). The setting of 6060 hex (Operation Mode) was changed at an interval of less than 2 ms. Homing was started when 6098 hex (Homing Method) was set to a value other than 8, 12, 19, 20, 33, 34, or 35. Data setting warnings (B0 hex) occurred continuously for the number of data setting warnings that is set in 3781 hex (Data Setting Warning Detection Count). 			√			Same as above.

Event code	Event name	Meaning	Assumed cause	Level					Reference
				Maj	Prt	Min	Obs	Info	
78010000 hex	Operation Command Competition	An attempt was made to establish EtherCAT communications or to turn ON the Servo from the Controller (enable operation) while executing an FFT that operates with the Servo Drive alone or a trial run.	<ul style="list-style-type: none"> EtherCAT communications (change from Init to Pre-operational state) was established or an attempt to turn ON the Servo from the Controller (enable operation) was made while executing an FFT that operates with the Servo Drive trial run. 			√			AC Servomotors/Servo Drives G5 Series with Built-in EtherCAT Communications User's Manual (Cat. No. I576)
78020000 hex	Absolute Encoder Status Error	The rotation of the encoder was higher than the specified value when the power supply was turned ON.	<ul style="list-style-type: none"> The rotation of the encoder was higher than the specified value when the power supply was turned ON. 			√			Same as above.
84B10000 hex	EtherCAT State Change Error	A communications state change command was received for which the current communications state could not be changed.	<ul style="list-style-type: none"> A communications state change command was received for which the current communications state could not be changed. 			√			Same as above.
84B20000 hex	EtherCAT Illegal State Change Error	An undefined communications state change command was received.	<ul style="list-style-type: none"> An undefined communications state change command was received. 			√			Same as above.
84B30000 hex	Communications Synchronization Error	The number of consecutive errors in receiving data during the communication sync time exceeded the value specified for the Communications Control Setting.	<ul style="list-style-type: none"> Power to the host controller was interrupted during PDO communications. An EtherCAT communications cable is disconnected, broken, or incorrectly connected. Noise 			√			Same as above.
84B40000 hex	Synchronization Error	A synchronization error occurred.	<ul style="list-style-type: none"> Noise Control PCB error 			√			Same as above.
84B50000 hex	Sync Manager WDT Error	PDO communications were stopped for more than the specified period of time.	<ul style="list-style-type: none"> The EtherCAT communications cable is disconnected or broken. There is an error in the host controller. 			√			Same as above.
84B60000 hex	ESC Initialization Error	An error occurred in ESC initialization.	<ul style="list-style-type: none"> Control PCB error 			√			Same as above.
84B70000 hex	Slave Unit Verification Error	An error occurred in Slave Unit verification.	<ul style="list-style-type: none"> Control PCB error 			√			Same as above.
84B80000 hex	Communications Setting Error	There is an error in the communications settings.	<ul style="list-style-type: none"> An out-of-range value was set from the host controller. A command that changes the communications state to an unsupported state was received. 			√			Same as above.
84B90000 hex	Synchronization Interruption Error	A synchronization interruption error occurred.	<ul style="list-style-type: none"> Control PCB error 			√			Same as above.

Event code	Event name	Meaning	Assumed cause	Level					Reference
				Maj	Prt	Min	Obs	Info	
98010000 hex	Absolute Value Cleared	The multi-rotation counter for the absolute encoder was cleared during USB communications by the CX-Drive.	<ul style="list-style-type: none"> The multi-rotation counter for the absolute encoder was cleared during USB communications by the CX-Drive. 			√			AC Servomotors/Servo Drives G5 Series with Built-in EtherCAT Communications User's Manual (Cat. No. I576)
98020000 hex	Position Data Initialized	A Config operation was performed or the multi-rotation counter was cleared for the absolute encoder during EtherCAT communications.	<ul style="list-style-type: none"> A Config operation was performed or the multi-rotation counter was cleared for the absolute encoder during EtherCAT communications. 			√			Same as above.
08010000 hex	Battery Warning	The battery voltage is 3.2 V or less.	<ul style="list-style-type: none"> The battery voltage is 3.2 V or lower. 				√		Same as above.
08020000 hex	Fan Warning	The fan stop state continued for 1 second.	<ul style="list-style-type: none"> There is foreign matter in the fan. The Servo Drive failed. 				√		Same as above.
08030000 hex	Encoder Communications Warning	Encoder communications errors occurred in series more frequently than the specified value.	<ul style="list-style-type: none"> There is insufficient power supply voltage for the encoder. Noise is entering on the encoder line. 				√		Same as above.
08040000 hex	Encoder Overheating Warning	The encoder temperature exceeded the specified value.	<ul style="list-style-type: none"> The ambient temperature is too high. Servomotor failed. 				√		Same as above.
08050000 hex	Life Expectancy Warning	The remaining life of the capacitor or the fan is shorter than the specified value.	<ul style="list-style-type: none"> The life expectancy of the capacitor or the fan is shorter than the specified value. 				√		Same as above.
08060000 hex	External Encoder Error Warning	The external encoder detected a warning.	<ul style="list-style-type: none"> There is insufficient power supply voltage for the external encoder. Noise is entering on the external encoder connector cable. The external encoder failed. 				√		Same as above.
08070000 hex	External Encoder Communications Warning	The external encoder had more communications errors than the specified value.	<ul style="list-style-type: none"> There is insufficient power supply voltage for the external encoder. Noise is entering on the external encoder connector cable. 				√		Same as above.
34E00000 hex	Data Setting Warning	An object setting is out of range.	<ul style="list-style-type: none"> An object setting is out of range. 				√		Same as above.
383C0000 hex	Overload Warning	The load ratio is 85% or more of the protection level.	<ul style="list-style-type: none"> Overload There is incorrect wiring of the motor line or a broken cable. 				√		Same as above.
383D0000 hex	Excessive Regeneration Warning	The regeneration load ratio is 85% or more of the level.	<ul style="list-style-type: none"> There is excessive regeneration. This Regeneration Resistor cannot be used for continuous regenerative braking. 				√		Same as above.
383E0000 hex	Vibration Detection Warning	Vibration was detected.	<ul style="list-style-type: none"> The gain or inertial ratio setting is not suitable. 				√		Same as above.

Event code	Event name	Meaning	Assumed cause	Level					Reference
				Maj	Prt	Min	Obs	Info	
74800000 hex	Command Warning	A command could not be executed.	<ul style="list-style-type: none"> The absolute multi-rotation counter was cleared when the Servo was not OFF when using an absolute encoder for semi-closed control. A forced brake operation request was sent while the Servo was ON. A Switch ON command was sent when the main power was OFF. (When 3508 hex = 0) An Enable Operation command was sent to request turning ON the Servo when the Servomotor was operating at 30 r/min or higher. A latch operation was started under the following conditions. <ul style="list-style-type: none"> An absolute external encoder was used and phase Z was selected as the trigger for fully-closed control. The absolute multi-rotation data was being cleared or the Config operation was being performed. The Statusword (6041 hex) bit 09 (remote) was 0 (local). An operation command is given in the prohibited direction after the motor made an immediate stop due to a drive prohibition input. 				√		AC Servomotors/Servo Drives G5 Series with Built-in EtherCAT Communications User's Manual (Cat. No. I576)
84B00000 hex	EtherCAT Communications Warning	An EtherCAT communications error occurred one or more times.	<ul style="list-style-type: none"> The EtherCAT communications cable is disconnected or broken. Noise 				√		Same as above.

MX2-series Inverters with EtherCAT Communications Units

Event code	Event name	Meaning	Assumed cause	Level					Reference
				Maj	Prt	Min	Obs	Info	
04A10000 hex	Non-volatile Memory Hardware Error	An error occurred in non-volatile memory.	<ul style="list-style-type: none"> Non-volatile memory failure 				√		MX2 Series Inverter EtherCAT Communication Unit User's Manual (Cat. No. I574)
04BA0000 hex	Connection Error between Inverter and Communications Unit	An error occurred in the connection between the Inverter and the EtherCAT Communications Unit for the Inverter.	<ul style="list-style-type: none"> Contact failure between the Inverter and the EtherCAT Communications Unit for the Inverter. Inverter trip was reset. The Inverter was initialized or the mode was changed. The EtherCAT Communications Unit for the Inverter failed. 				√		Same as above.
04BB0000 hex	Inverter Warning	An Inverter warning was detected.	<ul style="list-style-type: none"> An Inverter warning was detected. 				√		Same as above.

Event code	Event name	Meaning	Assumed cause	Level					Reference
				Maj	Prt	Min	Obs	Info	
04BC0000 hex	Inverter Trip	An Inverter trip was detected.	<ul style="list-style-type: none"> An Inverter trip was detected. 			√			MX2 Series Inverter EtherCAT Communication Unit User's Manual (Cat. No. I574)
34F00000 hex	PDO Setting Error	There is an illegal setting value in the PDO mapping.	<ul style="list-style-type: none"> The PDO mapping or Sync-Manager settings are incorrect. 			√			Same as above.

EtherCAT FQ-M-series Specialized Vision Sensors for Positioning

Event code	Event name	Meaning	Assumed cause	Level					Reference
				Maj	Prt	Min	Obs	Info	
78080000 hex	TRIG Input Error	A TRIG signal was input when the BUSY signal for Sensor measurement was ON.	<ul style="list-style-type: none"> A TRIG signal was input when the BUSY signal for Sensor measurement was ON. Chattering occurred for a contact input. 			√			FQ-M-series Specialized Vision Sensor for Positioning User's Manual (Cat. No. Z314)
780A0000 hex	Scene Data Error	The scene data to switch to is corrupted.	<ul style="list-style-type: none"> The power supply was interrupted when the scene data to switch to was saved. 			√			Same as above.
780B0000 hex	Model Error	A model was re-registered with an image with low contrast.	<ul style="list-style-type: none"> A model was re-registered with an image with low contrast. 			√			Same as above.
780C0000 hex	Logging Error	Some data was not saved when logging data to files on an SD card.	<ul style="list-style-type: none"> Too much data to log in files occurred in a short period of time, and writing to the SD card could not keep up. 			√			Same as above.
780D0000 hex	Output Timeout	A timeout occurred in data output handshaking control for measurement results.	<ul style="list-style-type: none"> The data output handshaking controls in the program (i.e., the ON/OFF timing of the DSA signal) are not correct. The output control timeout time is too short in comparison with the program processing time. 			√			Same as above.
780E0000 hex	Output Size Error	The data output size setting and the PDO mapping setting do not agree.	<ul style="list-style-type: none"> The EtherCAT data output size setting in the Sensor and the PDO mapping setting in the EtherCAT master do not agree. 			√			Same as above.

E3X-series Fiber Sensors with EtherCAT Communications Unit for Digital Sensors

Event code	Event name	Meaning	Assumed cause	Level					Reference
				Maj	Prt	Min	Obs	Info	
04C40000 hex	Sensor Communications Error	An error occurred in a Sensor connection.	<ul style="list-style-type: none"> The Sensor is disconnected. 			√			EtherCAT Digital-type Sensor Communications Unit Operation Manual (Cat. No. E413)
04C50000 hex	Sensor Communications Has Not Been Established	Communications has not been established with the Sensor.	<ul style="list-style-type: none"> A sensor is not connected. 			√			Same as above.
14A00000 hex	Non-volatile Memory Checksum Error	An error occurred in the control parameters.	<ul style="list-style-type: none"> Noise 			√			Same as above.
24780000 hex	Number of Sensors Verify Error	The number of Sensors that is connected does not agree with the settings.	<ul style="list-style-type: none"> The set value does not match the number of Sensors that are actually connected. 			√			Same as above.
24790000 hex	Number of Sensors Over Limit	Too many Sensors are connected.	<ul style="list-style-type: none"> More than the maximum number of Sensors are connected. 			√			Same as above.
34F80000 hex	Dummy Sensors Setting Error	Too many Dummy Units are set.	<ul style="list-style-type: none"> There are too many Dummy Units set, so some Sensors are not assigned logical unit numbers. 			√			Same as above.
04A10000 hex	Non-volatile Memory Hardware Error	An error occurred in non-volatile memory.	<ul style="list-style-type: none"> Non-volatile memory failure 				√		Same as above.

3-1-7 Errors in CJ-series Units

The section provides tables of the events that can occur in the CJ-series Units.

- Analog I/O Units
- Process I/O Units
- Temperature Control Units
- ID Sensor Units
- High-speed Counter Units
- Serial Communications Units
- DeviceNet Units
- EtherNet/IP Units

CJ-series Analog I/O Units

The section provides tables of the events that can occur in the following Units.

CJ1W-AD041-V1/AD081-V1

CJ1W-AD042

CJ1W-DA021/DA041

CJ1W-DA08V/DA08C

CJ1W-DA042V

CJ1W-MAD42

Event code	Event name	Meaning	Assumed cause	Level					Reference
				Maj	Prt	Min	Obs	Info	
04600000 hex	A/D Conversion Error	An error occurred in A/D conversion.	<ul style="list-style-type: none"> • There is a source of noise nearby. • A/D converter failed. 			√			CJ-series Analog I/O Units Operation Manual for NJ-series CPU Unit (Cat. No. W490)
04620000 hex	Non-volatile Memory Error	An error occurred in non-volatile memory.	<ul style="list-style-type: none"> • There is a source of noise nearby. • Non-volatile memory failed. 			√			Same as above.
34800000 hex	Mean Value Processing Setting Error	There is a mistake in the setting of the number of samplings for mean value processing.	<ul style="list-style-type: none"> • There is a mistake in the setting of the number of samplings for mean value processing. 			√			Same as above.
34830000 hex	Scaling Data Setting Error	There is a mistake in the scaling data settings.	<ul style="list-style-type: none"> • The upper or lower limit data for scaling is outside the setting range. Or, the maximum value and minimum value are not 0 and they are the same. 			√			Same as above.
34840000 hex	Input Signal Range Setting Error or Error in Number of Inputs Setting	There is a mistake in the input signal range setting or in the number of inputs setting.	<ul style="list-style-type: none"> • The settings of the input signal range or the setting of the number of analog inputs that are used is incorrect. 			√			Same as above.
34850000 hex	Mean Value Processing Setting Error	There is a mistake in the setting of the number of samplings for mean value processing.	<ul style="list-style-type: none"> • There is a mistake in the setting of the number of samplings for mean value processing. 			√			Same as above.

Event code	Event name	Meaning	Assumed cause	Level					Reference
				Maj	Prt	Min	Obs	Info	
34860000 hex	Error in Setting of Conversion Mode	There is a mistake in the Conversion Mode setting.	<ul style="list-style-type: none"> The specification of the Cyclic Conversion Mode or Direct Conversion Mode is not correct. 			√			CJ-series Analog I/O Units Operation Manual for NJ-series CPU Unit (Cat. No. W490)
34870000 hex	Output Hold Setting Error	There is a mistake in the output hold setting.	<ul style="list-style-type: none"> The setting for output status when conversion stops is incorrect. 			√			Same as above.
34890000 hex	Conversion Time/Resolution or Operation Mode Setting Error	There is a mistake in the conversion time/resolution or operation mode setting.	<ul style="list-style-type: none"> There is a mistake in the conversion time/resolution or operation mode setting. 			√			Same as above.
348A0000 hex	Output Signal Range Setting Error or Error In Number of Outputs Used Setting	There is a mistake in the output signal range setting or in the number of outputs setting.	<ul style="list-style-type: none"> There is a mistake in the output signal range setting or in the number of outputs setting. 			√			Same as above.
38010000 hex	Scaling Data Setting Error/Ratio Conversion Use Setting Error	There is an error in the scaling data setting or ratio conversion use setting.	<ul style="list-style-type: none"> The upper or lower limit data for scaling is outside the setting range. Or, the maximum value and minimum value are not 0 and they are the same. The I/O number for ratio conversion is set to <i>Not used</i> in the I/O specifications. 			√			Same as above.
38020000 hex	Ratio Set Value Error	There is a mistake in the ratio setting for ratio conversion.	<ul style="list-style-type: none"> A value other than 16#0000 to 16#9999 (0.00 to 99.99) was specified for the ratio conversion A constant for ratio conversion. 			√			Same as above.
64780000 hex	Input Disconnection Detected	The input is disconnected.	<ul style="list-style-type: none"> Input wiring is broken. Input wiring disconnection 			√			Same as above.
64790000 hex	Output Set Value Error	The output setting is out of range.	<ul style="list-style-type: none"> An output set value setting is out of range. 			√			Same as above.
34810000 hex	Input Value Exceeded Adjustment Range in Adjustment Mode	In Adjustment Mode, the input value exceeded the range for which adjustment is possible.	<ul style="list-style-type: none"> In Adjustment Mode, the input value exceeded the range for which adjustment is possible, so the offset and gain cannot be adjusted. 				√		Same as above.
34820000 hex	Input Number Specification Error in Adjustment Mode	The input number specified in Adjustment Mode is not enabled or the input number is wrong.	<ul style="list-style-type: none"> The input number that was specified in Adjustment Mode is not enabled. The setting of the Adjustment Input Number (device variable *_AdjCh) is incorrect, so adjustment is not possible. 				√		Same as above.
34880000 hex	Output Number Specification Error in Adjustment Mode	The output number specified in Adjustment Mode is not enabled or the output number is wrong.	<ul style="list-style-type: none"> The output number that was specified in Adjustment Mode is not enabled. The setting of the Adjustment Output Number (device variable *_AdjCh) is incorrect, so adjustment is not possible. 				√		Same as above.

Event code	Event name	Meaning	Assumed cause	Level					Reference
				Maj	Prt	Min	Obs	Info	
348C0000 hex	I/O Number Specification Error in Adjustment Mode	The I/O numbers specified in Adjustment Mode are not enabled or the I/O numbers are wrong.	<ul style="list-style-type: none"> The I/O numbers that were specified in Adjustment Mode are not enabled. The setting of the Adjustment I/O Number (device variable *_AdjCh) is incorrect, so adjustment is not possible. 				√		CJ-series Analog I/O Units Operation Manual for NJ-series CPU Unit (Cat. No. W490)

CJ-series Process I/O Units

The section provides tables of the events that can occur in the following Units.

CJ1W-PDC15

CJ1W-AD04U

CJ1W-PH41U

Event code	Event name	Meaning	Assumed cause	Level					Reference
				Maj	Prt	Min	Obs	Info	
04600000 hex	A/D Conversion Error	An error occurred in A/D conversion.	<ul style="list-style-type: none"> There is a source of noise nearby. A/D converter failed. 			√			CJ-series Analog I/O Units Operation Manual for NJ-series CPU Unit (Cat. No. W498)
04610000 hex	Cold Junction Sensor Error	An error occurred in the cold junction sensor.	<ul style="list-style-type: none"> Faulty connection to the cold junction sensor for the CJ1W-PH41U. The cold junction sensor failed. 			√			Same as above.
04620000 hex	Non-volatile Memory Error	An error occurred in non-volatile memory.	<ul style="list-style-type: none"> There is a source of noise nearby. Non-volatile memory failed. 			√			Same as above.
348D0000 hex	Data Range Error	A set value is out of range.	<ul style="list-style-type: none"> A set value is out of range. 			√			Same as above.
647A0000 hex	Input Error	An input error occurred.	<ul style="list-style-type: none"> The analog input signal is out of range. Input wiring is broken. Input wiring disconnection or loose terminal 			√			Same as above.
647D0000 hex	Zero/Span Adjustment Period End	The zero/span adjustment period expired.	<ul style="list-style-type: none"> The zero/span adjustment period expired. 				√		Same as above.
647E0000 hex	Zero/Span Adjustment Period Notice	The zero/span adjustment period is close to expiring.	<ul style="list-style-type: none"> The notification period for the expiration of zero/span adjustment occurred. 				√		Same as above.

CJ-series Temperature Control Units

The section provides tables of the events that can occur in the following Units.

CJ1W-TC003

CJ1W-TC004

CJ1W-TC103

CJ1W-TC104

Event code	Event name	Meaning	Assumed cause	Level					Reference
				Maj	Prt	Min	Obs	Info	
04680000 hex	Cold Junction Sensor Error	An error occurred in the cold junction sensor.	<ul style="list-style-type: none"> Faulty connection to the cold junction sensor. The cold junction sensor failed. 				√		CJ-series Temperature Control Units Operation Manual for NJ-series CPU Unit (Cat. No. W491)
34940000 hex	Setting Error	There is an illegal setting.	<ul style="list-style-type: none"> The set value is incorrect. 				√		Same as above.
64840000 hex	Sensor Error	An error occurred in the sensor input.	<ul style="list-style-type: none"> Error in input from the Sensor. 				√		Same as above.
64850000 hex	CT Overflow	An overflow occurred in the CT input.	<ul style="list-style-type: none"> The heater current exceeded 55.0 A. 				√		Same as above.
64860000 hex	Heater Burn-out Alarm	A heater burnout occurred.	<ul style="list-style-type: none"> The power supply to the heater is not ON. The heater is burned out or deteriorated. — 				√		Same as above.

CJ-series ID Sensor Units

The section provides tables of the events that can occur in the following Units.

CJ1W-V680C11

CJ1W-V680C12

Event code	Event name	Meaning	Assumed cause	Level					Reference
				Maj	Prt	Min	Obs	Info	
046C0000 hex	Unit Status, Antenna Power Supply Error	An error occurred in the power supply to the Antenna.	<ul style="list-style-type: none"> An error occurred in the power supply (24 V) to the Antenna. 			√			CJ-series ID Sensor Units Operation Manual for NJ-series CPU Unit (Cat. No. Z317)
046D0000 hex	Unit Status, Memory Error	An error occurred when reading non-volatile memory.	<ul style="list-style-type: none"> There is a source of noise nearby. Non-volatile memory failure 			√			Same as above.
046E0000 hex	Results Information, Antenna Error	An error occurred in the Antenna.	<ul style="list-style-type: none"> The Antenna is not connected. Antenna failure The ID Sensor Unit failed. 			√			Same as above.
046F0000 hex	Unit Status, Unit Busy	An error occurred in an ID Sensor Unit.	<ul style="list-style-type: none"> There is a source of noise nearby. The ID Sensor Unit failed. 			√			Same as above.

Event code	Event name	Meaning	Assumed cause	Level					Reference
				Maj	Prt	Min	Obs	Info	
24400000 hex	Unit Status, Antenna Error	An error occurred in the Antenna.	<ul style="list-style-type: none"> The setting of the Connected Antenna Setting (device variable *_Ch#_AntConn) does not agree with the Antenna that is connected. The V680-H01 or V680-H01-V2 was connected to the CJ1W-V680C12. 			√			CJ-series ID Sensor Units Operation Manual for NJ-series CPU Unit (Cat. No. Z317)
34980000 hex	Results Information, Data Storage Area Specification Error	The data storage area specification is not correct.	<ul style="list-style-type: none"> The user program specifies addresses in the DM, CIO, AR, EM, or other areas that exceed the ranges defined for the data storage area specifications. 			√			Same as above.
54A00000 hex	Results Information, ID Tag Address Error	The address of the ID Tag is wrong.	<ul style="list-style-type: none"> The address of an ID Tag specified in a command is incorrect. 			√			Same as above.
54A10000 hex	Results Information, Write Protection Error	An attempt was made to write to a write-protected area of the ID Tag.	<ul style="list-style-type: none"> The specified address or number of bytes is incorrect. Write-protection is enabled for the area you attempted to write to in the ID Tag. 			√			Same as above.
54A20000 hex	Results Information, Command Error	The command to the ID Sensor Unit is not correct.	<ul style="list-style-type: none"> The contents of the following external device variables is not data that can be specified (where # is the channel number). *_Ch#_CmdSet *_Ch#_ProcAdr *_Ch#_ProcByte *_Ch#_CmdOption “#” in the variable name is the Antenna (Head) number. 			√			Same as above.
648C0000 hex	Unit Status, Command Error End	A processing error occurred.	<ul style="list-style-type: none"> A processing error occurred. 			√			Same as above.
648D0000 hex	Results Information, Verification Error	The correct data could not be written to the ID Tag.	<ul style="list-style-type: none"> The travel speed of the ID Tag is outside the specified range. The distance between the Antenna and ID Tag is outside the specified range. Noise 			√			Same as above.
648E0000 hex	Results Information, ID Tag Communications Error	An error occurred in communications with an ID Tag, preventing a normal end.	<ul style="list-style-type: none"> The travel speed of the ID Tag is outside the specified range. The distance between the Antenna and ID Tag is outside the specified range. Noise 			√			Same as above.
648F0000 hex	Results Information, ID Tag Missing Error	There is no ID Tag in the communications area.	<ul style="list-style-type: none"> The communications specification is set to trigger, and the ID Tag is not in the communications area when the trigger occurs. The communications specification is set to single auto or repeat auto, and the wait time reached the Auto Wait Time. An Amplifier is connected, but an Antenna is not connected. 			√			Same as above.
64900000 hex	Results Information, ID System Error 1	ID system error 1 occurred.	<ul style="list-style-type: none"> System error 1 occurred. 			√			Same as above.

Event code	Event name	Meaning	Assumed cause	Level					Reference
				Maj	Prt	Min	Obs	Info	
64910000 hex	Results Information, ID System Error 2	ID system error 2 occurred.	<ul style="list-style-type: none"> System error 2 occurred. 			√			CJ-series ID Sensor Units Operation Manual for NJ-series CPU Unit (Cat. No. Z317)
64920000 hex	Results Information, ID System Error 3	ID system error 3 occurred.	<ul style="list-style-type: none"> System error 3 occurred. 			√			Same as above.
64930000 hex	Results Information, ID Tag Status	One of the following occurred. <ul style="list-style-type: none"> The number of writes was exceeded for a Number of Writes Control command. An overflow or underflow occurred for a Calculation Write command. The data did not verify for a Data Check command. An error occurred in the data for a Read with Error Correction command. An error occurred when writing for a Copy command. 	<ul style="list-style-type: none"> The number of writes was exceeded for a Number of Writes Control command. An overflow or underflow occurred for a Calculation Write command. The data did not verify for a Data Check command. An error occurred in the data for a Read with Error Correction command. An error occurred when writing for a Copy command. 			√			Same as above.
64940000 hex	Results Information, Error Correction	A Write with Error Correction command performed a 1-bit error correction.	<ul style="list-style-type: none"> There is ambient noise where the ID Tag is used. ID Tag error. 			√			Same as above.

CJ-series High-speed Counter Units

The section provides tables of the events that can occur in the following Units.

CJ1W-CT021

Event code	Event name	Meaning	Assumed cause	Level					Reference
				Maj	Prt	Min	Obs	Info	
68010000 hex	Unit Error	An error occurred in the High-speed Counter Unit.	<ul style="list-style-type: none"> There is an error in the Special Unit Setup. An overflow or underflow error occurred. An illegal preset value was used. A CPU Unit monitor error or bus error occurred. 			√			CJ-series High-speed Counter Units Operation Manual for NJ-series CPU Unit (Cat. No. W492)

CJ-series Serial Communications Units

The section provides tables of the events that can occur in the following Units.

CJ1W-SCU22

CJ1W-SCU32

CJ1W-SCU42

Event code	Event name	Meaning	Assumed cause	Level					Reference
				Maj	Prt	Min	Obs	Info	
04740000 hex	Error Log Data Error	An error occurred in the error log data.	<ul style="list-style-type: none"> There is a source of noise nearby. Non-volatile memory failure 			√			CJ-series Serial Communications Units Operation Manual for NJ-series CPU Unit (Cat. No. W494)
14800000 hex	Protocol Data Error	A protocol data checksum error has occurred.	<ul style="list-style-type: none"> The communications connector with the CX-Protocol was disconnected or the power supply to the Controller was interrupted during transfer of the protocol data from the CX-Protocol. The Serial Communications Unit failed. 			√			Same as above.
34A40000 hex	System Setup Error	There is an error in the system settings for the Serial Communications Unit.	<ul style="list-style-type: none"> There is an error in the system settings for the Serial Communications Unit. 			√			Same as above.
04750000 hex	DTR Check Error	An error was found during the DTR check.	<ul style="list-style-type: none"> Loopback test jig failure. Noise The communications circuits in the Serial Communications Unit are faulty. 				√		Same as above.
04760000 hex	CTS Check Error	An error was found during the CTS check.	<ul style="list-style-type: none"> Loopback test jig failure. Noise The communications circuits in the Serial Communications Unit are faulty. 				√		Same as above.
54A80000 hex	Command Error	A command error occurred.	<ul style="list-style-type: none"> The constant in the expected receive message that is set in the protocol macro is different from the constant in the message that was received. 				√		Same as above.
54A90000 hex	Sequence Abort Completed	The sequence was ended by an Abort setting for the next processing or error processing.	<ul style="list-style-type: none"> The protocol macro data is not set correctly. The baud rate, frame format, or other system setting does not agree with the remote node. 				√		Same as above.

Event code	Event name	Meaning	Assumed cause	Level					Reference
				Maj	Prt	Min	Obs	Info	
54AA0000 hex	Protocol Macro Error	An error occurred in the protocol macro.	<ul style="list-style-type: none"> Sequence No. Error: An unregistered number was specified for <i>SeqNo</i> (communications sequence number) of the ExecPMCR instruction (no indicators light). Data read/write area exceeded error: The specified area range was exceeded when data was written to or read from the CPU Unit. (The ERC indicator and ERR/ALM indicator will flash.) Protocol data syntax error: There was a code that cannot be executed during protocol execution. (The ERC indicator and ERR/ALM indicator will flash.) The total of the areas specified for link words O1, O2, I1, and I2 exceeded 500 words. The same link word is used by both ports 1 and 2. Writing was specified with a constant. Interrupt notification was specified for a Serial Communications Unit. Thirty one or more items were set for the write attribute data for one message. A length of 0 bytes was specified for a message that was sent or received. The length of a message to be sent or received exceeds the maximum send/receive bytes. A message is not registered for matrix reception. The transmission control is set to both RTS/CTS flow control and Xon/Xoff flow control. 				√		CJ-series Serial Communications Units Operation Manual for NJ-series CPU Unit (Cat. No. W494)
64A00000 hex	Tfs (Send Finished Monitoring Time) Exceeded	The time required to complete a send operation exceeded the Send Finished Monitoring Time.	<ul style="list-style-type: none"> Noise The monitor time is shorter than the actual completion time. 				√		Same as above.
64A10000 hex	Tfr (Receive Finished Monitoring Time) Exceeded	The time required to complete a reception operation exceeded the Receive Finished Monitoring Time.	<ul style="list-style-type: none"> Noise The monitoring time is shorter than the actual completion time. 				√		Same as above.
64A20000 hex	Tr (Receive Wait Monitoring Time) Exceeded	The receive waiting time exceeded the Receive Wait Monitoring Time.	<ul style="list-style-type: none"> Noise The monitoring time is shorter than the actual completion time. 				√		Same as above.

Event code	Event name	Meaning	Assumed cause	Level					Reference
				Maj	Prt	Min	Obs	Info	
64A30000 hex	FCS Check Error	<p>One of the following errors occurred in the converted protocol at the serial gateway.</p> <ul style="list-style-type: none"> When converting to CompoWay/F command: BCC error When converting to Modbus-RTU command: CRC error When converting to Modbus-ASCII command: CRC error When converting to Host Link FINS command: FCS error <p>Protocol Macros</p> <ul style="list-style-type: none"> The check code attached to the received message does not match the check code that was calculated from the received message. 	<ul style="list-style-type: none"> Noise There was a mistake in the CRC code that was attached to the command frame. 				√		CJ-series Serial Communications Units Operation Manual for NJ-series CPU Unit (Cat. No. W494)

Event code	Event name	Meaning	Assumed cause	Level					Reference
				Maj	Prt	Min	Obs	Info	
64A40000 hex	Timeout Error	A timeout error occurred.	<ul style="list-style-type: none"> In Protocol Macro Mode (the SD□ indicator does not flash at all): The Serial Communications Unit received a command, but the step transition of the protocol macro communications sequence is suspended for one of the following reasons. <ul style="list-style-type: none"> The next step is a RECEIVE command. A WAIT command is presently in execution. In Serial Gateway Mode or Protocol Macro Mode (the SD□ indicator flashes, but the RD□ does not flash): <ul style="list-style-type: none"> There is no remote device to receive the command after conversion at the specified destination address. The sent command frame is illegal. The settings for the communications conditions and baud rate of the serial communications path do not match the remote device. The communications cable wiring is faulty or incorrect, the terminating resistance settings of the RS-424A/485 port are incorrect, or the adapter wiring or terminating resistance settings for the NT-AL001 are incorrect. The protocol of the sent command was unable to be interpreted by the remote device. Remote device hardware failure In Serial Gateway Mode or Protocol Macro Mode (RD□/SD□ indicator flashes): <ul style="list-style-type: none"> The response from the remote device was too fast, and the data received by the Serial Communications Unit was discarded. The Serial Gateway Response Timeout Monitoring Time for the <i>*_P1_PmrSgwRespTimeout Cfg</i> or <i>*_P2_PmrSgwRespTimeout Cfg</i> device variable is too short. During Loopback Test <ul style="list-style-type: none"> Loopback test jig failure. Noise The communications circuits in the Serial Communications Unit are faulty. 				√		CJ-series Serial Communications Units Operation Manual for NJ-series CPU Unit (Cat. No. W494)

Event code	Event name	Meaning	Assumed cause	Level					Reference
				Maj	Prt	Min	Obs	Info	
64A40000 hex	Timeout Error	A timeout error occurred.	<ul style="list-style-type: none"> A serial gateway cannot interrupt processing between protocol macro steps. If the message frame is corrupted due to noise, a response timeout occurred at the FINS send source if the <i>*_P1_TimeoutErr</i> or <i>*_P2_TimeoutErr</i> device variable is FALSE. A no-protocol instruction was executed when No-protocol Mode was not set. 				√		CJ-series Serial Communications Units Operation Manual for NJ-series CPU Unit (Cat. No. W494)
64A50000 hex	Comparison Error	A comparison error occurred.	<ul style="list-style-type: none"> Loopback test jig failure. Noise The communications circuits in the Serial Communications Unit are faulty. 				√		Same as above.
64A60000 hex	Reception Overflow	More than the specified amount of receive data was received in No-protocol Mode.	<ul style="list-style-type: none"> One or more bytes of data was received after the completion the reception. 				√		Same as above.
64A70000 hex	Command Format Error	An illegal function code or address was specified in a received Modbus-RTU command.	<ul style="list-style-type: none"> An illegal function code, address, or data was specified in a received Modbus-RTU command. 				√		Same as above.
84680000 hex	Transmission Error	A transmission error occurred.	<ul style="list-style-type: none"> One of the following errors occurred. <ul style="list-style-type: none"> Tfs (Send Finished Monitoring Time) Exceeded Tfr (Receive Finished Monitoring Time) Exceeded Tr (Receive Wait Monitoring Time) Exceeded FCS Check Error Command Error Timeout Error Overrun Error Framing Error Parity Error 				√		Same as above.
84690000 hex	Overrun Error	An overrun occurred.	<ul style="list-style-type: none"> In Serial Gateway Mode or Protocol Macro Mode: <ul style="list-style-type: none"> The reception circuits in the Serial Communications Unit are faulty. A transmission error occurred due to noise or other factors. No-protocol Mode: <ul style="list-style-type: none"> The reception buffer received more than 259 bytes of data before the SerialRcv instruction was executed. During Loopback Test <ul style="list-style-type: none"> Loopback test jig failure. Noise The communications circuits in the Serial Communications Unit are faulty. 				√		Same as above.

Event code	Event name	Meaning	Assumed cause	Level					Reference
				Maj	Prt	Min	Obs	Info	
846A0000 hex	Framing Error	A frame error occurred.	<ul style="list-style-type: none"> In Serial Gateway Mode or Protocol Macro Mode: <ul style="list-style-type: none"> The reception circuits in the Serial Communications Unit are faulty. A transmission error occurred due to noise or other factors. During Loopback Test <ul style="list-style-type: none"> Loopback test jig failure. Noise The communications circuits in the Serial Communications Unit are faulty. 				√		CJ-series Serial Communications Units Operation Manual for NJ-series CPU Unit (Cat. No. W494)
846B0000 hex	Parity Error	A parity error occurred.	<ul style="list-style-type: none"> In Serial Gateway Mode or Protocol Macro Mode: <ul style="list-style-type: none"> The reception circuits in the Serial Communications Unit are faulty. A transmission error occurred due to noise or other factors. During Loopback Test <ul style="list-style-type: none"> Loopback test jig failure. Noise The communications circuits in the Serial Communications Unit are faulty. 				√		Same as above.
846C0000 hex	Overrun Error, Framing Error, or Parity Error (Transmission Error)	An overrun error, framing error, or parity error occurred.	<ul style="list-style-type: none"> The communications conditions and baud rate settings do not match the host. Noise or other external interference. The baud rate is outside the allowable range or there are bit errors due to different stop bit settings or other parameters. The communications cable wiring is faulty. Terminating resistance is not set correctly for the RS-422A/485 ports. Wiring is faulty or terminating resistance is not set correctly on an NT-AL001 or other Adapter. 				√		Same as above.
846D0000 hex	Transmission Error (CRC Error)	A CRC error occurred.	<ul style="list-style-type: none"> Noise CRC calculation method does not match the device. 				√		Same as above.

CJ-series DeviceNet Units

The section provides tables of the events that can occur in the following Units.

CJ1W-DRM21

Event code	Event name	Meaning	Assumed cause	Level					Reference
				Maj	Prt	Min	Obs	Info	
04880000 hex	Unit Memory Error	An error occurred when writing to internal memory where the error history is saved.	<ul style="list-style-type: none"> There is a source of noise nearby. Non-volatile memory failure 			√			CJ-series DeviceNet Units Operation Manual for NJ-series CPU Unit (Cat. No. W497)
04890000 hex	Network Power Error	Network power is not being supplied.	<ul style="list-style-type: none"> Communications power is not being supplied normally from the network. 			√			Same as above.
148D0000 hex	Invalid Scan List Data	There is an error in the contents of the slave scan list or master scan list stored in non-volatile memory.	<ul style="list-style-type: none"> The power was interrupted during writing the scan list to the non-volatile memory. 			√			Same as above.
148E0000 hex	Invalid Setup Data	There is illegal data in the settings for the slave function.	<ul style="list-style-type: none"> The power was interrupted while the system was writing the parameters. Non-volatile memory life 			√			Same as above.
24480000 hex	Node Address Duplicated Error	An error was discovered during the node address duplication check when starting the DeviceNet Unit.	<ul style="list-style-type: none"> The node address of the DeviceNet Unit is also set for another node. 			√			Same as above.
34BC0000 hex	Routing Table Error	There is illegal data in the routing tables set in the CPU Unit.	<ul style="list-style-type: none"> The local DeviceNet Unit is not in the routing tables. The routing table format is incorrect. Reading the routing tables timed out. 			√			Same as above.

Event code	Event name	Meaning	Assumed cause	Level					Reference
				Maj	Prt	Min	Obs	Info	
34BD0000 hex	Verification Error	The slave information registered in the scan list does not agree with the actual slave information.	<ul style="list-style-type: none"> • A slave that is in the scan list does not exist. • The node address of the local Unit, which is the master, is registered in the scan list. • If the system is set to check the vendor in the detailed verification settings, the vendor of the slave does not match the registration in the scan list. • If the connection path is set in the detailed verification settings, then setting the connection path that is set in the scan list failed. • The size of the slave I/O data does not match the registration in the scan list. • If the device type is set in the detailed verification settings, then setting the device type that is set in the scan list failed. • If the product code is set in the detailed verification settings, then setting the product code that is set in the scan list failed. • The device does not support the I/O service specified in the scan list. 			√			CJ-series DeviceNet Units Operation Manual for NJ-series CPU Unit (Cat. No. W497)
34BE0000 hex	Structure Error	The scan list is disabled and an error occurred that prevented making I/O allocations.	<ul style="list-style-type: none"> • The I/O words allocated to slave overlap. • The I/O words allocated to the slave exceed the valid range. • The I/O size of the slave exceeds 200 bytes for outputs or 200 bytes for inputs. 			√			Same as above.
34BF0000 hex	Master I/O Refresh Error	The I/O memory in the destination CPU Unit for I/O refreshing could not be found when refreshing the master function data in the CPU Unit.	<ul style="list-style-type: none"> • I/O words are allocated in an EM bank that does not exist. 			√			Same as above.
34C00000 hex	Master User-set Allocations User Setting Failed	An error occurred in the following operation for user allocation of the master.	<ul style="list-style-type: none"> • The master function is not enabled. • There is a mistake in the user allocations in the master. • CPU Unit is not in PROGRAM mode. • More than one software switch changed to TRUE at the same time. Or, another software switch changed to TRUE before processing was completed for a previous software switch. 			√			Same as above.
34C10000 hex	Communications Cycle Time Setting Failed	An error occurred in one of the following operations when setting the communications cycle time.	<ul style="list-style-type: none"> • There is an error in the set information. • CPU Unit is not in PROGRAM mode. 			√			Same as above.

Event code	Event name	Meaning	Assumed cause	Level					Reference
				Maj	Prt	Min	Obs	Info	
34C20000 hex	Slave I/O Refresh Error	The I/O memory in the destination CPU Unit for I/O refreshing could not be found when refreshing the slave function data in the CPU Unit.	<ul style="list-style-type: none"> I/O words are allocated in an EM bank that does not exist. 			√			CJ-series DeviceNet Units Operation Manual for NJ-series CPU Unit (Cat. No. W497)
34C30000 hex	Slave User Allocation Area Setting Failed	An error occurred in the following operation for user allocation of the slave.	<ul style="list-style-type: none"> The slave function is not disabled. There is a mistake in the user allocations to a slave. CPU Unit is not in PROGRAM mode. More than one software switch changed to TRUE at the same time. Or, another software switch changed to TRUE before processing was completed for a previous software switch. 			√			Same as above.
64AC0000 hex	Send Timeout Error	A send timeout occurred.	<ul style="list-style-type: none"> There is no slave or other device on the network. The same baud rate is not set for all nodes. Communications cable lengths (trunk line and branch lines) are unsuitable. A communications cable is disconnected or loose. The terminating resistance is somewhere other than the ends of the trunk line. Noise There is an error in the CAN controller. 			√			Same as above.
74600000 hex	Master Function Enable/Disable Failed	An operating error occurred when enabling or disabling the master function.	<ul style="list-style-type: none"> An attempt was made to enable the master function when it was already enabled. An attempt was made to disable the master function when it was already disabled. CPU Unit is not in PROGRAM mode. More than one software switch changed to TRUE at the same time. Or, another software switch changed to TRUE before processing was completed for a previous software switch. 			√			Same as above.
74610000 hex	Master Fixed Allocation Area Setting Failed	An error occurred in one of the following operations for fixed allocation of the master.	<ul style="list-style-type: none"> The master function is not enabled. The scan list is not disabled. CPU Unit is not in PROGRAM mode. More than one software switch changed to TRUE at the same time. Or, another software switch changed to TRUE before processing was completed for a previous software switch. 			√			Same as above.

Event code	Event name	Meaning	Assumed cause	Level					Reference
				Maj	Prt	Min	Obs	Info	
74620000 hex	Scan List Register/Clear Failed	An operating error occurred when registering or clearing the scan list by performing one of the following operations.	<ul style="list-style-type: none"> • CPU Unit is not in PROGRAM mode. • Request processing is not possible in this status or the request was made when the operation was already in progress. The following are the main causes of Unit status errors. <ul style="list-style-type: none"> • A software switch operation for the master function was executed when the master function was disabled. • A switch that can be used only when the scan list is disabled was used when the scan list was enabled. • A switch that can be used only when the scan list is enabled was used when the scan list was disabled. • A software switch operation for the slave function was executed when the slave function was disabled. • A configuration error has occurred. • There is an error in the parameters specified in the user settings, and the requested setting could not be made. • More than one software switch changed to TRUE at the same time. Or, another software switch changed to TRUE before processing was completed for a previous software switch. 			√			CJ-series DeviceNet Units Operation Manual for NJ-series CPU Unit (Cat. No. W497)
74630000 hex	Slave Function Enable/Disable Failed	An error occurred in one of the following operations in the slave function.	<ul style="list-style-type: none"> • An attempt was made to enable the slave function when it was already enabled. • An attempt was made to disable the slave function when it was already disabled. • CPU Unit is not in PROGRAM mode. • More than one software switch changed to TRUE at the same time. Or, another software switch changed to TRUE before processing was completed for a previous software switch. 			√			Same as above.
74640000 hex	Slave Fixed Allocation Area Setting Failed	An error occurred in one of the following operations for fixed allocation of the slave.	<ul style="list-style-type: none"> • The slave function is not disabled. • CPU Unit is not in PROGRAM mode. • More than one software switch changed to TRUE at the same time. Or, another software switch changed to TRUE before processing was completed for a previous software switch. 			√			Same as above.

Event code	Event name	Meaning	Assumed cause	Level					Reference
				Maj	Prt	Min	Obs	Info	
84740000 hex	Bus Off Detected	A Bus Off error occurred (i.e., communications stopped because there were too many communications errors).	<ul style="list-style-type: none"> The master and slave have different baud rates. Communications cable lengths (trunk line and branch lines) are unsuitable. A communications cable is disconnected or loose. The terminating resistance is somewhere other than the ends of the trunk line. Noise 			√			CJ-series DeviceNet Units Operation Manual for NJ-series CPU Unit (Cat. No. W497)
84750000 hex	Remote I/O Communications Error	A timeout occurred in remote I/O communications.	<ul style="list-style-type: none"> The master and slaves have different baud rates. Communications cable lengths (trunk line and branch lines) are unsuitable. A communications cable is disconnected or loose. The terminating resistance is somewhere other than the ends of the trunk line. Noise 			√			Same as above.
84760000 hex	Remote I/O Communications Error (during Slave Operation)	An error occurred in remote I/O communications.	<ul style="list-style-type: none"> The master is not in operation. The master and slaves have different baud rates. Communications cable lengths (trunk line and branch lines) are unsuitable. A communications cable is disconnected or loose. The terminating resistance is somewhere other than the ends of the trunk line. Noise 			√			Same as above.
84770000 hex	Slave COS Send Failed	An attempt was made to send COS data to the master using the Slave COS Send Switch (software switch 2, device variable <i>*_Sw2SlavCOSSendCmd</i>), but the send failed.	<ul style="list-style-type: none"> A COS connection to the master is not open. A Bus Off state occurred. A network power error occurred. A send timeout occurred. 			√			Same as above.
048A0000 hex	File Read/Write Error	An error occurred when user setup data was read from an SD Memory Card in the CPU Unit or when data was written as a file to an SD Memory Card.	<ul style="list-style-type: none"> The available capacity on the SD Memory Card was insufficient to write a file. Write-protection is set on the SD Memory Card when you write to a file. Noise The SD Memory Card is damaged. The CPU Unit has failed. 				√		Same as above.
148C0000 hex	Invalid Message Timer List Error	The data in the message monitoring timer list is not correct.	<ul style="list-style-type: none"> The power supply was interrupted while writing the message-monitoring timer list to the non-volatile memory. 				√		Same as above.

CJ-series EtherNet/IP Unit

The following table lists the events that can occur for an EtherNet/IP Unit with the following model number.

CJ1W-EIP21

Event code	Event name	Meaning	Assumed cause	Level					Reference
				Maj	Prt	Min	Obs	Info	
047A0000 hex	Unit Memory Error (Device Error)	An error occurred when writing to the error history or device parameters in non-volatile memory in the EtherNet/IP Unit.	<ul style="list-style-type: none"> There is a source of noise nearby. Non-volatile memory failure 			√			CJ-series EtherNet/IP Units Operation Manual for NJ-series CPU Unit (Cat. No. W495)
047B0000 hex	Non-volatile Memory Error	An error occurred in non-volatile memory.	<ul style="list-style-type: none"> There is a source of noise nearby. Non-volatile memory failure 			√			Same as above.
047C0000 hex	Communications Controller Error	An error occurred in the communications controller.	<ul style="list-style-type: none"> Noise Communications Controller hardware error 			√			Same as above.
14840000 hex	Invalid Communications Parameter	An error was found in the validation check of the parameters for tag data links that are saved in non-volatile memory.	<ul style="list-style-type: none"> There is a source of noise nearby. Non-volatile memory failure 			√			Same as above.
14850000 hex	Tag Database Error	A tag database error occurred in the CPU Unit when using variables for tag data links, status layout, etc.	<ul style="list-style-type: none"> The power was interrupted during a download. A communications error occurred during a download. 			√			Same as above.
34A80000 hex	Verification Error	The information registered for a target node in the tag data link parameters is different from the actual node information.	<ul style="list-style-type: none"> The specified target does not exist. Variable names do not match. The connection size is incorrect. Insufficient connection resources 			√			Same as above.
34A90000 hex	Tag Data Link Error	There were two or more errors in a connection as an originator. The following are excluded.	<ul style="list-style-type: none"> The power supply to the target node is OFF. Communications with the target node stop. The Ethernet cable for EtherNet/IP is disconnected. The Ethernet cable for EtherNet/IP is disconnected. Noise 			√			Same as above.
34AA0000 hex	Tag Refresh Error	An unsupported data area or address range is specified for the tag data links.	<ul style="list-style-type: none"> An unsupported data area or address range was specified for the tag data links. 			√			Same as above.
34AB0000 hex	Basic Ethernet Setting Error	There is an illegal TCP/IP setting.	<ul style="list-style-type: none"> The power was interrupted during a download. A communications error occurred during a download. 			√			Same as above.

Event code	Event name	Meaning	Assumed cause	Level					Reference
				Maj	Prt	Min	Obs	Info	
34AC0000 hex	IP Address Table Error	The IP address table information is incorrect.	<ul style="list-style-type: none"> The power was interrupted during a download. A communications error occurred during a download. 			√			CJ-series EtherNet/IP Units Operation Manual for NJ-series CPU Unit (Cat. No. W495)
34AD0000 hex	IP Router Table Error	The IP router table information is incorrect.	<ul style="list-style-type: none"> The power was interrupted during a download. A communications error occurred during a download. 			√			Same as above.
34AE0000 hex	Routing Table Error	The routing table information is incorrect.	<ul style="list-style-type: none"> The power was interrupted during a download. A communications error occurred during a download. 			√			Same as above.
34AF0000 hex	Ethernet Advanced Setting Error	There is an illegal FINS setting.	<ul style="list-style-type: none"> The power was interrupted during a download. A communications error occurred during a download. 			√			Same as above.
34B00000 hex	Address Mismatch	The host ID of the local IP address is inconsistent with the FINS node address. Or, the last segment of the local IP address is inconsistent with the setting on the node address switches.	<ul style="list-style-type: none"> The IP address conversion method is set to automatic generation, but the host ID of the local IP address is inconsistent with the FINS node address or the last segment of the local IP address is inconsistent with the setting on the node address switch. 			√			Same as above.
381C0000 hex	Status Area Layout Setting Error	An error occurred in the layout setting of the EtherNet/IP Unit.	<ul style="list-style-type: none"> There is an error in the layout settings of the EtherNet/IP Unit. 			√			Same as above.
54AE0000 hex	Multiple Switches ON Error	More than one software switch changed to TRUE at the same time.	<ul style="list-style-type: none"> More than one software switch changed to TRUE at the same time. Or, another software switch changed to TRUE before processing was completed for a previous software switch. 			√			Same as above.
84010000 hex	IP Address Duplication Error	The same IP address is used more than once.	<ul style="list-style-type: none"> The IP address of the EtherNet/IP port is also used as the IP address of another node. 			√			Same as above.
84020000 hex	BOOTP Server Error	Connection with the BOOTP server failed.	<ul style="list-style-type: none"> Server setting error (The acquired IP address is illegal.) Server is down. An error occurred in the communications path. 			√			Same as above.
54E00000 hex	Variable Access Error	Accessing a tag variable that is used in a tag data link failed.	<ul style="list-style-type: none"> An out-of-range value was written by an EtherNet/IP tag data link for a variable that specifies SUBRANGE. 				√		Same as above.
84060000 hex	Link OFF Error	The Ethernet link status turned OFF.	<ul style="list-style-type: none"> The Ethernet cable is disconnected. An Ethernet cable is disconnected or loose. The switching hub power supply is turned OFF. Baud rate mismatch. Noise 				√		Same as above.

3-2 Events in Order of Event Codes

This section provides a table of all events in order of the event codes. Events that are not errors are also given in the tables.

3-2-1 Interpreting Error Descriptions

The contents of the error table is described below.

Item	Description
Event code	The event code of the error in the NJ-series Controller is given. The codes are given in eight hexadecimal digits.
Event name	The name of the event is given
Functional classification	A functional classification of the source is given.
Reference	The catalog number of the manual that provides details on the event are given.

Refer to information for the specified functional classification of the error in the error descriptions in the manual given in the *Reference* column in the tables for detailed information on an error.

The manual names are given below for the catalog numbers.

Cat. No.	Manual name
W500	NJ-series CPU Unit Hardware User's Manual
W501	NJ-series CPU Unit Software User's Manual
W490	CJ-series Analog I/O Units Operation Manual for NJ-series CPU Unit
W491	CJ-series Temperature Control Units Operation Manual for NJ-series CPU Unit
W492	CJ-series High-speed Counter Units Operation Manual for NJ-series CPU Unit
W498	CJ-series Analog I/O Units Operation Manual for NJ-series CPU Unit
W488	GX-series EtherCAT Slave Units User's Manual
W494	CJ-series Serial Communications Units Operation Manual for NJ-series CPU Unit
W495	CJ-series EtherNet/IP Units Operation Manual for NJ-series CPU Unit
W497	CJ-series DeviceNet Units Operation Manual for NJ-series CPU Unit
W505	NJ-series CPU Unit Built-in EtherCAT Port User's Manual
W506	NJ-series CPU Unit Built-in EtherNet/IP Port User's Manual
I574	MX2 Series Inverter EtherCAT Communication Unit User's Manual
W507	NJ-series CPU Unit Motion Control User's Manual
W508	NJ-series Motion Control Instructions Reference Manual
I576	AC Servomotors/Servo Drives G5 Series with Built-in EtherCAT Communications User's Manual
E413	EtherCAT Digital-type Sensor Communications Unit Operation Manual
Z317	CJ-series ID Sensor Units Operation Manual for NJ-series CPU Unit
Z314	FQ-M-series Specialized Vision Sensor for Positioning User's Manual

Events that are marked with an asterisk in the *Event code* column were added for version upgrades. Refer to *3-1 Errors by Source* for the versions for which events can occur.

3-2-2 Error Table

Event code	Event name	Functional classification	Reference
00080000 hex	Real-Time Clock Failed	Errors for Self Diagnosis	W500
00090000 hex	DIP Switch Setting Error	Errors for Self Diagnosis	W500
00070000 hex	Real-Time Clock Stopped	Errors for Self Diagnosis	W500
000B0000 hex	Low Battery Voltage	Errors for Self Diagnosis	W500
000C0000 hex	CPU Unit Overheat	Errors for Self Diagnosis	W500
000D0000 hex	Internal NJ-series Bus Check Error	Errors for Self Diagnosis	W500
000E0000 hex	Non-volatile Memory Life Exceeded	Errors for Self Diagnosis	W500
000F0000 hex	SD Memory Card Invalid Type	Errors for Self Diagnosis	W500
00100000 hex	SD Memory Card Life Exceeded	Errors for Self Diagnosis	W500
04010000 hex	I/O Bus Check Error	Errors Related to Unit Configuration	W500
04200000 hex	Communications Controller Failure	Built-in EtherNet/IP Port on CPU Unit	W506
04400000 hex	Communications Controller Failure	Built-in EtherCAT Master in CPU Unit	W500
04600000 hex	A/D Conversion Error	CJ-series Analog I/O Units and CJ-series Process I/O Units	W490, W498
04610000 hex	Cold Junction Sensor Error	CJ-series Process I/O Units	W498
04620000 hex	Non-volatile Memory Error	CJ-series Analog I/O Units and CJ-series Process I/O Units	W490, W498
04680000 hex	Cold Junction Sensor Error	CJ-series Temperature Control Units	W491
046C0000 hex	Unit Status, Antenna Power Supply Error	CJ-series ID Sensor Units	Z317
046D0000 hex	Unit Status, Memory Error	CJ-series ID Sensor Units	Z317
046E0000 hex	Results Information, Antenna Error	CJ-series ID Sensor Units	Z317
046F0000 hex	Unit Status, Unit Busy	CJ-series ID Sensor Units	Z317
04740000 hex	Error Log Data Error	CJ-series Serial Communications Units	W494
04750000 hex	DTR Check Error	CJ-series Serial Communications Units	W494
04760000 hex	CTS Check Error	CJ-series Serial Communications Units	W494
047A0000 hex	Unit Memory Error (Device Error)	CJ-series EtherNet/IP Units	W495
047B0000 hex	Non-volatile Memory Error	CJ-series EtherNet/IP Units	W495
047C0000 hex	Communications Controller Error	CJ-series EtherNet/IP Units	W495
04880000 hex	Unit Memory Error	CJ-series DeviceNet Units	W497
04890000 hex	Network Power Error	CJ-series DeviceNet Units	W497
048A0000 hex	File Read/Write Error	CJ-series DeviceNet Units	W497
04A10000 hex	Non-volatile Memory Hardware Error	Block I/O (GX-series EtherCAT Slave Units), MX2-series Inverters with EtherCAT Communications Units, EtherCAT M3X Photoelectric Fiber Amplifiers, and E3X-series Fiber Sensors with EtherCAT Communications Unit for Digital Sensors	W488, I574, and E413
04A80000 hex	Control Power Supply Undervoltage	G5-series Servo Drives with Built-in EtherCAT Communications	I576
04A90000 hex	Overvoltage	G5-series Servo Drives with Built-in EtherCAT Communications	I576

Event code	Event name	Functional classification	Reference
04AA0000 hex	Main Circuit Power Supply Undervoltage (Undervoltage between positive and negative terminals)	G5-series Servo Drives with Built-in EtherCAT Communications	I576
04AB0000 hex	Main Circuit Power Supply Undervoltage (AC Cutoff Detected)	G5-series Servo Drives with Built-in EtherCAT Communications	I576
04AC0000 hex	Overcurrent	G5-series Servo Drives with Built-in EtherCAT Communications	I576
04AD0000 hex	IPM Error	G5-series Servo Drives with Built-in EtherCAT Communications	I576
04AE0000 hex	Regeneration Tr Error	G5-series Servo Drives with Built-in EtherCAT Communications	I576
04AF0000 hex	Encoder Phase-Z Error	G5-series Servo Drives with Built-in EtherCAT Communications	I576
04B00000 hex	Encoder CTS Signal Error	G5-series Servo Drives with Built-in EtherCAT Communications	I576
04B10000 hex	Node Address Setting Error	G5-series Servo Drives with Built-in EtherCAT Communications	I576
04BA0000 hex	Connection Error between Inverter and Communications Unit	MX2-series Inverters with EtherCAT Communications Units	I574
04BB0000 hex	Inverter Warning	MX2-series Inverters with EtherCAT Communications Units	I574
04BC0000 hex	Inverter Trip	MX2-series Inverters with EtherCAT Communications Units	I574
04C40000 hex	Sensor Communications Error	E3X-series Fiber Sensors with EtherCAT Communications Unit for Digital Sensors	E413
04C50000 hex	Sensor Communications Has Not Been Established	E3X-series Fiber Sensors with EtherCAT Communications Unit for Digital Sensors	E413
08010000 hex	Battery Warning	G5-series Servo Drives with Built-in EtherCAT Communications	I576
08020000 hex	Fan Warning	G5-series Servo Drives with Built-in EtherCAT Communications	I576
08030000 hex	Encoder Communications Warning	G5-series Servo Drives with Built-in EtherCAT Communications	I576
08040000 hex	Encoder Overheating Warning	G5-series Servo Drives with Built-in EtherCAT Communications	I576
08050000 hex	Life Expectancy Warning	G5-series Servo Drives with Built-in EtherCAT Communications	I576
08060000 hex	External Encoder Error Warning	G5-series Servo Drives with Built-in EtherCAT Communications	I576
08070000 hex	External Encoder Communications Warning	G5-series Servo Drives with Built-in EtherCAT Communications	I576
08080000 hex	Encoder Communications Disconnection Error	G5-series Servo Drives with Built-in EtherCAT Communications	I576
08090000 hex	Encoder Communications Error	G5-series Servo Drives with Built-in EtherCAT Communications	I576
080A0000 hex	Encoder Communications Data Error	G5-series Servo Drives with Built-in EtherCAT Communications	I576
080B0000 hex	Safety Input Error	G5-series Servo Drives with Built-in EtherCAT Communications	I576
080C0000 hex	External Encoder Connection Error	G5-series Servo Drives with Built-in EtherCAT Communications	I576

Event code	Event name	Functional classification	Reference
080D0000 hex	External Encoder Communications Data Error	G5-series Servo Drives with Built-in EtherCAT Communications	I576
080E0000 hex	External Encoder Status Error 0	G5-series Servo Drives with Built-in EtherCAT Communications	I576
080F0000 hex	External Encoder Status Error 1	G5-series Servo Drives with Built-in EtherCAT Communications	I576
08100000 hex	External Encoder Status Error 2	G5-series Servo Drives with Built-in EtherCAT Communications	I576
08110000 hex	External Encoder Status Error 3	G5-series Servo Drives with Built-in EtherCAT Communications	I576
08120000 hex	External Encoder Status Error 4	G5-series Servo Drives with Built-in EtherCAT Communications	I576
08130000 hex	External Encoder Status Error 5	G5-series Servo Drives with Built-in EtherCAT Communications	I576
08140000 hex	Phase-A Connection Error	G5-series Servo Drives with Built-in EtherCAT Communications	I576
08150000 hex	Phase-B Connection Error	G5-series Servo Drives with Built-in EtherCAT Communications	I576
08160000 hex	Phase-Z Connection Error	G5-series Servo Drives with Built-in EtherCAT Communications	I576
08170000 hex	Encoder Data Restoration Error	G5-series Servo Drives with Built-in EtherCAT Communications	I576
08180000 hex	External Encoder Data Restoration Error	G5-series Servo Drives with Built-in EtherCAT Communications	I576
10010000 hex	Non-volatile Memory Restored or Formatted	Errors for Self Diagnosis	W500
10020000 hex	Non-volatile Memory Data Corrupted	Errors for Self Diagnosis	W500
10030000 hex	SD Memory Card Invalid Format	Errors for Self Diagnosis	W500
10040000 hex	SD Memory Card Restored or Formatted	Errors for Self Diagnosis	W500
10060000 hex	SD Memory Card Data Corrupted	Errors for Self Diagnosis	W500
10070000 hex	SD Memory Card Access Power OFF Error	Errors for Self Diagnosis	W500
10080000 hex	Main Memory Check Error	Errors for Self Diagnosis	W500
10090000 hex	Battery-backup Memory Check Error	Errors for Self Diagnosis	W500
10200000 hex	User Program/Controller Configurations and Setup Transfer Error	Errors Related to Controller Operation	W500, W501
10210000 hex	Illegal User Program Execution ID	Errors Related to Controller Operation	W500, W501
10230000 hex	Event Log Restoration Error	Errors Related to Controller Operation	W500, W501
10240000 hex	Illegal User Program	Errors Related to Controller Operation	W500, W501
10250000 hex	Illegal User Program/Controller Configurations and Setup	Errors Related to Controller Operation	W500, W501
10260000 hex	Trace Setting Transfer Failure	Errors Related to Controller Operation	W500, W501
14010000 hex	CPU Bus Unit Setup Area Error	Errors Related to FINS Communications	W501
14200000 hex	MAC Address Error	Built-in EtherNet/IP Port on CPU Unit	W506
14210000 hex	Identity Error	Built-in EtherNet/IP Port on CPU Unit	W506
14220000 hex	EtherNet/IP Processing Error	Built-in EtherNet/IP Port on CPU Unit	W506

Event code	Event name	Functional classification	Reference
14400000 hex	MAC Address Error	Built-in EtherCAT Master in CPU Unit	W505
14600000 hex	Absolute Encoder Home Offset Read Error	General Motion Control	W507
14610000 hex	Motion Control Parameter Setting Error	General Motion Control	W507
14620000 hex	Cam Data Read Error	General Motion Control	W507
14630000 hex	Cam Table Save Error	General Motion Control	W507
14800000 hex	Protocol Data Error	CJ-series Serial Communications Units	W494
14840000 hex	Invalid Communications Parameter	CJ-series EtherNet/IP Units	W495
14850000 hex	Tag Database Error	CJ-series EtherNet/IP Units	W495
148C0000 hex	Invalid Message Timer List Error	CJ-series DeviceNet Units	W497
148D0000 hex	Invalid Scan List Data	CJ-series DeviceNet Units	W497
148E0000 hex	Invalid Setup Data	CJ-series DeviceNet Units	W497
14A00000 hex	Non-volatile Memory Checksum Error	EtherCAT-compatible Block I/O and E3X-series Fiber Sensors with EtherCAT Communications Unit for Digital Sensors	W488 and E413
14A80000 hex	Object Error	G5-series Servo Drives with Built-in EtherCAT Communications	I576
14A90000 hex	Object Error	G5-series Servo Drives with Built-in EtherCAT Communications	I576
14AA0000 hex	Object Error	G5-series Servo Drives with Built-in EtherCAT Communications	I576
14AB0000 hex	Object Corrupted	G5-series Servo Drives with Built-in EtherCAT Communications	I576
14AC0000 hex	Object Corrupted	G5-series Servo Drives with Built-in EtherCAT Communications	I576
14AD0000 hex	Object Corrupted	G5-series Servo Drives with Built-in EtherCAT Communications	I576
18200000 hex	Absolute Encoder Overspeed Error	G5-series Servo Drives with Built-in EtherCAT Communications	I576
18210000 hex	Encoder Initialization Error	G5-series Servo Drives with Built-in EtherCAT Communications	I576
18220000 hex	Absolute Encoder One-rotation Counter Error	G5-series Servo Drives with Built-in EtherCAT Communications	I576
18230000 hex	Absolute Encoder Multi-rotation Counter Error	G5-series Servo Drives with Built-in EtherCAT Communications	I576
24010000 hex	Unsupported Unit Detected	Errors Related to Unit Configuration	W500
24020000 hex	Too Many I/O Points	Errors Related to Unit Configuration	W500
24030000 hex	End Cover Missing	Errors Related to Unit Configuration	W500
24040000 hex	Incorrect Unit/Expansion Rack Connection	Errors Related to Unit Configuration	W500
24050000 hex	Duplicate Unit Number	Errors Related to Unit Configuration	W500
24200000 hex	Slave Node Address Duplicated	Built-in EtherCAT Master in CPU Unit	W505
24400000 hex	Unit Status, Antenna Error	CJ-series ID Sensor Units	Z317
24480000 hex	Node Address Duplicated Error	CJ-series DeviceNet Units	W497
24610000 hex	Switch Setting Error	Block I/O (GX-series EtherCAT Slave Units)	W488
24680000 hex	Motor Non-conformity	G5-series Servo Drives with Built-in EtherCAT Communications	I576

Event code	Event name	Functional classification	Reference
24690000 hex	Motor Non-conformity	G5-series Servo Drives with Built-in EtherCAT Communications	I576
246A0000 hex	Motor Non-conformity	G5-series Servo Drives with Built-in EtherCAT Communications	I576
246B0000 hex	Motor Non-conformity	G5-series Servo Drives with Built-in EtherCAT Communications	I576
246C0000 hex	Motor Non-conformity	G5-series Servo Drives with Built-in EtherCAT Communications	I576
24780000 hex	Number of Sensors Verify Error	E3X-series Fiber Sensors with EtherCAT Communications Unit for Digital Sensors	E413
24790000 hex	Number of Sensors Over Limit	E3X-series Fiber Sensors with EtherCAT Communications Unit for Digital Sensors	E413
34010000 hex	I/O Setting Check Error	Errors Related to Unit Configuration	W500
34100000 hex	IP Address Table Setting Error	Errors Related to FINS Communications	W501
34110000 hex	Unknown Destination Node	Errors Related to FINS Communications	W501
34130000 hex	FINS/TCP Connection Table Setting Error	Errors Related to FINS Communications	W501
34200000 hex	Tag Data Link Setting Error	Built-in EtherNet/IP Port on CPU Unit	W506
34210000 hex	Basic Ethernet Setting Error	Built-in EtherNet/IP Port on CPU Unit	W506
34220000 hex	TCP/IP Basic Setting Error (Local Port IP Address)	Built-in EtherNet/IP Port on CPU Unit	W506
34230000 hex	TCP/IP Advanced Setting Error (IP Router Table)	Built-in EtherNet/IP Port on CPU Unit	W506
34240000 hex	FTP Server Setting Error	Built-in EtherNet/IP Port on CPU Unit	W506
34250000 hex	NTP Client Setting Error	Built-in EtherNet/IP Port on CPU Unit	W506
34260000 hex	SNMP Setting Error	Built-in EtherNet/IP Port on CPU Unit	W506
34270000 hex	Tag Name Resolution Error	Built-in EtherNet/IP Port on CPU Unit	W506
34400000 hex	Network Configuration Information Error	Built-in EtherCAT Master in CPU Unit	W505
34600000 hex	Required Process Data Object Not Set	General Motion Control	W507
34610000 hex	Process Data Object Setting Missing	Motion Control Instructions	W508
34630000 hex	Axis Slave Disabled	General Motion Control	W507
34640000 hex	Network Configuration Information Missing for Axis Slave	General Motion Control	W507
34800000 hex	Mean Value Processing Setting Error	CJ-series Analog I/O Units	W490
34810000 hex	Input Value Exceeded Adjustment Range in Adjustment Mode	CJ-series Analog I/O Units	W490
34820000 hex	Input Number Specification Error in Adjustment Mode	CJ-series Analog I/O Units	W490
34830000 hex	Scaling Data Setting Error	CJ-series Analog I/O Units	W490
34840000 hex	Input Signal Range Setting Error or Error in Number of Inputs Setting	CJ-series Analog I/O Units	W490
34850000 hex	Mean Value Processing Setting Error	CJ-series Analog I/O Units	W490
34860000 hex	Error in Setting of Conversion Mode	CJ-series Analog I/O Units	W490
34870000 hex	Output Hold Setting Error	CJ-series Analog I/O Units	W490

Event code	Event name	Functional classification	Reference
34880000 hex	Output Number Specification Error in Adjustment Mode	CJ-series Analog I/O Units	W490
34890000 hex	Conversion Time/Resolution Setting Error or Operation Mode Setting Error	CJ-series Analog I/O Units	W490
348A0000 hex	Output Signal Range Setting Error or Error In Number of Outputs Used Setting	CJ-series Analog I/O Units	W490
348C0000 hex	I/O Number Specification Error in Adjustment Mode	CJ-series Analog I/O Units	W490
348D0000 hex	Data Range Error	CJ-series Process I/O Units	W498
34940000 hex	Setting Error	CJ-series Temperature Control Units	W491
34980000 hex	Results Information, Data Storage Area Specification Error	CJ-series ID Sensor Units	Z317
34A40000 hex	System Setup Error	CJ-series Serial Communications Units	W494
34A80000 hex	Verification Error	CJ-series EtherNet/IP Units	W495
34A90000 hex	Tag Data Link Error	CJ-series EtherNet/IP Units	W495
34AA0000 hex	Tag Refresh Error	CJ-series EtherNet/IP Units	W495
34AB0000 hex	Basic Ethernet Setting Error	CJ-series EtherNet/IP Units	W495
34AC0000 hex	IP Address Table Error	CJ-series EtherNet/IP Units	W495
34AD0000 hex	IP Router Table Error	CJ-series EtherNet/IP Units	W495
34AE0000 hex	Routing Table Error	CJ-series EtherNet/IP Units	W495
34AF0000 hex	Ethernet Advanced Setting Error	CJ-series EtherNet/IP Units	W495
34B00000 hex	Address Mismatch	CJ-series EtherNet/IP Units	W495
34BC0000 hex	Routing Table Error	CJ-series DeviceNet Units	W497
34BD0000 hex	Verification Error	CJ-series DeviceNet Units	W497
34BE0000 hex	Structure Error	CJ-series DeviceNet Units	W497
34BF0000 hex	Master I/O Refresh Error	CJ-series DeviceNet Units	W497
34C00000 hex	Master User-set Allocations User Setting Failed	CJ-series DeviceNet Units	W497
34C10000 hex	Communications Cycle Time Setting Failed	CJ-series DeviceNet Units	W497
34C20000 hex	Slave I/O Refresh Error	CJ-series DeviceNet Units	W497
34C30000 hex	Slave User Allocation Area Setting Failed	CJ-series DeviceNet Units	W497
34E00000 hex	Data Setting Warning	G5-series Servo Drives with Built-in EtherCAT Communications	I576
34E10000 hex	Servo Drive Overheat	G5-series Servo Drives with Built-in EtherCAT Communications	I576
34E20000 hex	Overload	G5-series Servo Drives with Built-in EtherCAT Communications	I576
34E30000 hex	Regeneration Overload	G5-series Servo Drives with Built-in EtherCAT Communications	I576
34E40000 hex	Error Counter Overflow	G5-series Servo Drives with Built-in EtherCAT Communications	I576
34E50000 hex	Excessive Velocity Error	G5-series Servo Drives with Built-in EtherCAT Communications	I576
34E60000 hex	Overspeed	G5-series Servo Drives with Built-in EtherCAT Communications	I576
34F00000 hex	PDO Setting Error	MX2-series Inverters with EtherCAT Communications Units	I574

Event code	Event name	Functional classification	Reference
34F80000 hex	Dummy Sensors Setting Error	E3X-series Fiber Sensors with EtherCAT Communications Unit for Digital Sensors	E413
38010000 hex	Scaling Data Setting Error/Ratio Conversion Use Setting Error	CJ-series Analog I/O Units	W490
38020000 hex	Ratio Set Value Error	CJ-series Analog I/O Units	W490
381C0000 hex	Status Area Layout Setting Error	CJ-series EtherNet/IP Units	W495
383C0000 hex	Overload Warning	G5-series Servo Drives with Built-in EtherCAT Communications	I576
383D0000 hex	Excessive Regeneration Warning	G5-series Servo Drives with Built-in EtherCAT Communications	I576
383E0000 hex	Vibration Detection Warning	G5-series Servo Drives with Built-in EtherCAT Communications	I576
383F0000 hex	Excessive Hybrid Following Error	G5-series Servo Drives with Built-in EtherCAT Communications	I576
38400000 hex	Overspeed 2	G5-series Servo Drives with Built-in EtherCAT Communications	I576
38410000 hex	Command Error	G5-series Servo Drives with Built-in EtherCAT Communications	I576
38420000 hex	Command Generation Error	G5-series Servo Drives with Built-in EtherCAT Communications	I576
38430000 hex	Error Counter Overflow 1	G5-series Servo Drives with Built-in EtherCAT Communications	I576
38440000 hex	Error Counter Overflow 2	G5-series Servo Drives with Built-in EtherCAT Communications	I576
38450000 hex	Interface Input Duplicate Allocation Error 1	G5-series Servo Drives with Built-in EtherCAT Communications	I576
38460000 hex	Interface Input Duplicate Allocation Error 2	G5-series Servo Drives with Built-in EtherCAT Communications	I576
38470000 hex	Interface Input Function Number Error 1	G5-series Servo Drives with Built-in EtherCAT Communications	I576
38480000 hex	Interface Input Function Number Error 2	G5-series Servo Drives with Built-in EtherCAT Communications	I576
38490000 hex	Interface Output Function Number Error 1	G5-series Servo Drives with Built-in EtherCAT Communications	I576
384A0000 hex	Interface Output Function Number Error 2	G5-series Servo Drives with Built-in EtherCAT Communications	I576
384B0000 hex	External Latch Input Allocation Error	G5-series Servo Drives with Built-in EtherCAT Communications	I576
384C0000 hex	Overrun Limit Error	G5-series Servo Drives with Built-in EtherCAT Communications	I576
384D0000 hex	Absolute Encoder System Down Error	G5-series Servo Drives with Built-in EtherCAT Communications	I576
384E0000 hex	Absolute Encoder Counter Overflow Error	G5-series Servo Drives with Built-in EtherCAT Communications	I576
384F0000 hex	Object Setting Error 1	G5-series Servo Drives with Built-in EtherCAT Communications	I576
38500000 hex	Object Setting Error 2	G5-series Servo Drives with Built-in EtherCAT Communications	I576
38510000 hex	External Encoder Connection Error	G5-series Servo Drives with Built-in EtherCAT Communications	I576
38520000 hex	Function Setting Error	G5-series Servo Drives with Built-in EtherCAT Communications	I576

Event code	Event name	Functional classification	Reference
40160000 hex	Safe Mode	Errors Related to Controller Operation	W500, W501
44010000Hex	EtherCAT Fault	Built-in EtherCAT Master in CPU Unit	W505
44200000 hex	Motion Control Initialization Error	General Motion Control	W507
54200000 hex	Electronic Gear Ratio Numerator Setting Out of Range	Motion Control Instructions	W508
54210000 hex	Electronic Gear Ratio Denominator Setting Out of Range	Motion Control Instructions	W508
54220000 hex	Target Velocity Setting Out of Range	Motion Control Instructions	W508
54230000 hex	Acceleration Setting Out of Range	Motion Control Instructions	W508
54240000 hex	Deceleration Setting Out of Range	Motion Control Instructions	W508
54250000 hex	Jerk Setting Out of Range	Motion Control Instructions	W508
54270000 hex	Torque Ramp Setting Out of Range	Motion Control Instructions	W508
54280000 hex	Master Coefficient Scaling Out of Range	Motion Control Instructions	W508
54290000 hex	Slave Coefficient Scaling Out of Range	Motion Control Instructions	W508
542A0000 hex	Feeding Velocity Setting Out of Range	Motion Control Instructions	W508
542B0000 hex	Buffer Mode Selection Out of Range	Motion Control Instructions	W508
542C0000 hex	Coordinate System Selection Out of Range	Motion Control Instructions	W508
542D0000 hex	Circular Interpolation Mode Selection Out of Range	Motion Control Instructions	W508
542E0000 hex	Direction Selection Out of Range	Motion Control Instructions	W508
542F0000 hex	Path Selection Out of Range	Motion Control Instructions	W508
54300000 hex	Position Type Selection Out of Range	Motion Control Instructions	W508
54310000 hex	Travel Mode Selection Out of Range	Motion Control Instructions	W508
54320000 hex	Transition Mode Selection Out of Range	Motion Control Instructions	W508
54330000 hex	Continue Method Selection Out of Range	Motion Control Instructions	W508
54340000 hex	Combine Mode Selection Out of Range	Motion Control Instructions	W508
54350000 hex	Synchronization Start Condition Selection Out of Range	Motion Control Instructions	W508
54360000 hex	Master and Slave Defined as Same Axis	Motion Control Instructions	W508
54370000 hex	Master and Auxiliary Defined as Same Axis	Motion Control Instructions	W508
54380000 hex	Master/Slave Axis Numbers Not in Ascending Order	Motion Control Instructions	W508
54390000 hex	Incorrect Cam Table Specification	Motion Control Instructions	W508
543A0000 hex	Synchronization Stopped	Motion Control Instructions	W508
543B0000 hex	Motion Control Instruction Re-execution Disabled	Motion Control Instructions	W508
543C0000 hex	Motion Control Instruction Multi-execution Disabled	Motion Control Instructions	W508
543D0000 hex	Instruction Not Allowed for Encoder Axis Type	Motion Control Instructions	W508

Event code	Event name	Functional classification	Reference
543E0000 hex	Instruction Cannot Be Executed during Multi-axes Coordinated Control	Motion Control Instructions	W508
543F0000 hex	Multi-axes Coordinated Control Instruction Executed for Disabled Axes Group	Motion Control Instructions	W508
54400000 hex	Axes Group Cannot Be Enabled	Motion Control Instructions	W508
54410000 hex	Impossible Axis Operation Specified when the Servo is OFF	Motion Control Instructions	W508
54420000 hex	Composition Axis Stopped Error	Motion Control Instructions	W508
54430000 hex	Motion Control Instruction Multi-execution Buffer Limit Exceeded	Motion Control Instructions	W508
54440000 hex	Insufficient Travel Distance	Motion Control Instructions	W508
54450000 hex	Insufficient Travel Distance to Achieve Blending Transit Velocity	Motion Control Instructions	W508
54460000 hex	Move Link Constant Velocity Insufficient Travel Distance	Motion Control Instructions	W508
54470000 hex	Positioning Gear Operation Insufficient Target Velocity	Motion Control Instructions	W508
54480000 hex	Same Start Point and End Point for Circular Interpolation	Motion Control Instructions	W508
54490000 hex	Circular Interpolation Center Specification Position Out of Range	Motion Control Instructions	W508
544A0000 hex	Circular Interpolation Cannot Be Executed with Rotary (Infinite) Axis	Motion Control Instructions	W508
544C0000 hex	Parameter Selection Out of Range	Motion Control Instructions	W508
544D0000 hex	Stop Method Selection Out of Range	Motion Control Instructions	W508
544E0000 hex	Latch ID Selection Out of Range for Trigger Input Condition	Motion Control Instructions	W508
544F0000 hex	Setting Out of Range for Writing MC Setting	Motion Control Instructions	W508
54500000 hex	Trigger Input Condition Mode Selection Out of Range	Motion Control Instructions	W508
54510000 hex	Drive Trigger Signal Selection Out of Range for Trigger Input Condition	Motion Control Instructions	W508
54530000 hex	Motion Control Instruction Re-execution Disabled (Axis Specification)	Motion Control Instructions	W508
54540000 hex	Motion Control Instruction Re-execution Disabled (Buffer Mode Selection)	Motion Control Instructions	W508
54550000 hex	Motion Control Instruction Re-execution Disabled (Direction Selection)	Motion Control Instructions	W508
54560000 hex	Motion Control Instruction Re-execution Disabled (Execution Mode)	Motion Control Instructions	W508
54570000 hex	Motion Control Instruction Re-execution Disabled (Axes Group Specification)	Motion Control Instructions	W508
54580000 hex	Motion Control Instruction Re-execution Disabled (Jerk Setting)	Motion Control Instructions	W508
54590000 hex	Motion Control Instruction Re-execution Disabled (Master Axis)	Motion Control Instructions	W508
545A0000 hex	Motion Control Instruction Re-execution Disabled (MasterOffset)	Motion Control Instructions	W508

Event code	Event name	Functional classification	Reference
545B0000 hex	Motion Control Instruction Re-execution Disabled (MasterScaling)	Motion Control Instructions	W508
545C0000 hex	Motion Control Instruction Re-execution Disabled (MasterStartDistance)	Motion Control Instructions	W508
545D0000 hex	Motion Control Instruction Re-execution Disabled (Continuous)	Motion Control Instructions	W508
545E0000 hex	Motion Control Instruction Re-execution Disabled (MoveMode)	Motion Control Instructions	W508
545F0000 hex	Illegal Auxiliary Axis Specification	Motion Control Instructions	W508
54600000 hex	Illegal Axis Specification	Motion Control Instructions	W508
54610000 hex	Illegal Axes Group Specification	Motion Control Instructions	W508
54620000 hex	Illegal Master Axis Specification	Motion Control Instructions	W508
54630000 hex	Motion Control Instruction Re-execution Disabled (SlaveOffset)	Motion Control Instructions	W508
54640000 hex	Motion Control Instruction Re-execution Disabled (SlaveScaling)	Motion Control Instructions	W508
54650000 hex	Motion Control Instruction Re-execution Disabled (StartPosition)	Motion Control Instructions	W508
54660000 hex	Instruction Execution Error with Undefined Home	Motion Control Instructions	W508
54670000 hex	Motion Control Instruction Re-execution Disabled (Position Type)	Motion Control Instructions	W508
54680000 hex	Unused Axis Specification for Master Axis	Motion Control Instructions	W508
54690000 hex	First Position Setting Out of Range	Motion Control Instructions	W508
546A0000 hex	Last Position Setting Out of Range	Motion Control Instructions	W508
546B0000 hex	Illegal First/Last Position Size Relationship (Linear Mode)	Motion Control Instructions	W508
546C0000 hex	Master Sync Start Position Setting Out of Range	Motion Control Instructions	W508
546D0000 hex	Slave Sync Start Position Setting Out of Range	Motion Control Instructions	W508
546E0000 hex	Duplicate Latch ID for Trigger Input Condition	Motion Control Instructions	W508
546F0000 hex	Jerk Override Factor Out of Range	Motion Control Instructions	W508
54700000 hex	Acceleration/Deceleration Override Factor Out of Range	Motion Control Instructions	W508
54710000 hex	First Position Method Specification Out of Range	Motion Control Instructions	W508
54720000 hex	Motion Control Instruction Re-execution Disabled (First Position Method)	Motion Control Instructions	W508
54740000 hex	Unused Axis Specification for Auxiliary Axis	Motion Control Instructions	W508
54750000 hex	Position Gear Value Error	Motion Control Instructions	W508
54760000 hex	Position Gear Master Axis Zero Velocity	Motion Control Instructions	W508
54770000 hex	Cam Table Data Error during Cam Motion	General Motion Control	W507
54780000 hex	Target Position Setting Out of Range	Motion Control Instructions	W508
54790000 hex	Travel Distance Out of Range	Motion Control Instructions	W508

Event code	Event name	Functional classification	Reference
547A0000 hex	Cam Table Start Point Setting Out of Range	Motion Control Instructions	W508
547B0000 hex	Cam Master Axis Following First Position Setting Out of Range	Motion Control Instructions	W508
547C0000 hex	Circular Interpolation Radius Setting Error	Motion Control Instructions	W508
547D0000 hex	Circular Interpolation Radius Overflow	Motion Control Instructions	W508
547E0000 hex	Circular Interpolation Setting Out of Range	Motion Control Instructions	W508
547F0000 hex	Auxiliary/Slave Axis Numbers Not in Ascending Order	Motion Control Instructions	W508
54800000 hex	Cam Table Property Ascending Data Error at Update	Motion Control Instructions	W508
54810000 hex	MC_Write Target Out of Range	Motion Control Instructions	W508
54820000 hex	Master Travel Distance Specification Out of Range	Motion Control Instructions	W508
54830000 hex	Master Distance in Acceleration Specification Out of Range	Motion Control Instructions	W508
54840000 hex	Master Distance in Deceleration Specification Out of Range	Motion Control Instructions	W508
54850000 hex	Immediate Stop Instruction Executed	General Motion Control	W507
54860000 hex	Axes Group Immediate Stop Instruction Executed	General Motion Control	W507
54870000 hex	Execution Mode Selection Out of Range	Motion Control Instructions	W508
54880000 hex	Permitted Following Error Out of Range	Motion Control Instructions	W508
54890000 hex	Border Point/Center Position/Radius Specification Out of Range	Motion Control Instructions	W508
548A0000 hex	End Point Specification Out of Range	Motion Control Instructions	W508
548B0000 hex	Slave Travel Distance Specification Out of Range	Motion Control Instructions	W508
548C0000 hex	Phase Shift Amount Out of Range	Motion Control Instructions	W508
548D0000 hex	Feeding Distance Out of Range	Motion Control Instructions	W508
548E0000 hex	Auxiliary and Slave Defined as Same Axis	Motion Control Instructions	W508
548F0000 hex	Relative Position Selection Out of Range	Motion Control Instructions	W508
54900000 hex	Cam Transition Specification Out of Range	Motion Control Instructions	W508
54910000 hex	Synchronized Control End Mode Selection Out of Range	Motion Control Instructions	W508
54920000 hex	Enable External Latch Instruction Execution Disabled	Motion Control Instructions	W508
54930000 hex	Master Axis Offset Out of Range	Motion Control Instructions	W508
54940000 hex	Slave Axis Offset Out of Range	Motion Control Instructions	W508
54950000 hex	Command Current Position Count Selection Out of Range	Motion Control Instructions	W508
54960000 hex	Master Axis Gear Ratio Numerator Out of Range	Motion Control Instructions	W508

Event code	Event name	Functional classification	Reference
54970000 hex	Master Axis Gear Ratio Denominator Out of Range	Motion Control Instructions	W508
54980000 hex	Auxiliary Axis Gear Ratio Numerator Out of Range	Motion Control Instructions	W508
54990000 hex	Auxiliary Axis Gear Ratio Denominator Out of Range	Motion Control Instructions	W508
549A0000 hex	Master Axis Position Type Selection Out of Range	Motion Control Instructions	W508
549B0000 hex	Auxiliary Axis Position Type Selection Out of Range	Motion Control Instructions	W508
549C0000 hex	Target Position Ring Counter Out of Range	Motion Control Instructions	W508
549D0000 hex*	Axes Group Composition Axis Setting Out of Range	Motion Control Instructions	W508
54A00000 hex	Results Information, ID Tag Address Error	CJ-series ID Sensor Units	Z317
54A10000 hex	Results Information, Write Protection Error	CJ-series ID Sensor Units	Z317
54A20000 hex	Results Information, Command Error	CJ-series ID Sensor Units	Z317
54A80000 hex	Command Error	CJ-series Serial Communications Units	W494
54A90000 hex	Sequence Abort Completed	CJ-series Serial Communications Units	W494
54AA0000 hex	Protocol Macro Error	CJ-series Serial Communications Units	W494
54AE0000 hex	Multiple Switches ON Error	CJ-series EtherNet/IP Units	W495
54E00000 hex	Variable Access Error	Built-in EtherNet/IP Port on CPU Unit	W506
60010000 hex	Task Period Exceeded	Errors Related to Tasks	W501
60020000 hex	Task Execution Timeout	Errors Related to Tasks	W501
60030000 hex	I/O Refreshing Timeout Error	Errors Related to Tasks	W501
60040000 hex	Insufficient System Service Time Error	Errors Related to Tasks	W501
60050000 hex	Task Period Exceeded	Errors Related to Tasks	W501
64010000 hex	Impossible to Access Special Unit	Errors Related to Unit Configuration	W500
64200000 hex	Emergency Message Detected	Built-in EtherCAT Master in CPU Unit	W505
64400000 hex	Target Position Positive Software Limit Exceeded	General Motion Control	W508
64410000 hex	Target Position Negative Software Limit Exceeded	General Motion Control	W508
64420000 hex	Command Position Overflow/Underflow	General Motion Control	W508
64430000 hex	Positive Limit Input	General Motion Control	W508
64440000 hex	Negative Limit Input	General Motion Control	W508
64450000 hex	Positive Software Limit Exceeded	General Motion Control	W507
64460000 hex	Negative Software Limit Exceeded	General Motion Control	W507
64470000 hex	In-position Check Time Exceeded	General Motion Control	W507

Event code	Event name	Functional classification	Reference
64480000 hex	Following Error Limit Exceeded	General Motion Control	W507
64490000 hex	Immediate Stop Input	General Motion Control	W507
644A0000 hex	Positive Limit Input Detected	General Motion Control	W507
644B0000 hex	Negative Limit Input Detected	General Motion Control	W507
644C0000 hex	Following Error Warning	General Motion Control	W507
644D0000 hex	Velocity Warning	General Motion Control	W507
644E0000 hex	Acceleration Warning	General Motion Control	W507
644F0000 hex	Deceleration Warning	General Motion Control	W507
64500000 hex	Positive Torque Warning	General Motion Control	W507
64510000 hex	Negative Torque Warning	General Motion Control	W507
64520000 hex	Command Position Overflow	General Motion Control	W507
64530000 hex	Command Position Underflow	General Motion Control	W507
64540000 hex	Actual Position Overflow	General Motion Control	W507
64550000 hex	Actual Position Underflow	General Motion Control	W507
64560000 hex	Illegal Following Error	General Motion Control	W507
64570000 hex	Servo OFF Error	General Motion Control	W507
64580000 hex	Absolute Encoder Current Position Calculation Failed	General Motion Control	W507
64590000 hex	Home Undefined during Coordinated Motion	General Motion Control	W507
64780000 hex	Input Disconnection Detected	CJ-series Analog I/O Units	W490
64790000 hex	Output Set Value Error	CJ-series Analog I/O Units	W490
647A0000 hex	Input Error	CJ-series Process I/O Units	W498
647D0000 hex	Zero/Span Adjustment Period End	CJ-series Process I/O Units	W498
647E0000 hex	Zero/Span Adjustment Period Notice	CJ-series Process I/O Units	W498
64840000 hex	Sensor Error	CJ-series Temperature Control Units	W491
64850000 hex	CT Overflow	CJ-series Temperature Control Units	W491
64860000 hex	Heater Burnout Alarm	CJ-series Temperature Control Units	W491
648C0000 hex	Unit Status, Command Error End	CJ-series ID Sensor Units	Z317
648D0000 hex	Results Information, Verification Error	CJ-series ID Sensor Units	Z317
648E0000 hex	Results Information, ID Tag Communications Error	CJ-series ID Sensor Units	Z317
648F0000 hex	Results Information, ID Tag Missing Error	CJ-series ID Sensor Units	Z317
64900000 hex	Results Information, ID System Error 1	CJ-series ID Sensor Units	Z317
64910000 hex	Results Information, ID System Error 2	CJ-series ID Sensor Units	Z317
64920000 hex	Results Information, ID System Error 3	CJ-series ID Sensor Units	Z317
64930000 hex	Results Information, ID Tag Status	CJ-series ID Sensor Units	Z317
64940000 hex	Results Information, Error Correction	CJ-series ID Sensor Units	Z317
64A00000 hex	Tfs (Send Finished Monitoring Time) Exceeded	CJ-series Serial Communications Units	W494
64A10000 hex	Tfr (Receive Finished Monitoring Time) Exceeded	CJ-series Serial Communications Units	W494
64A20000 hex	Tr (Receive Wait Monitoring Time) Exceeded	CJ-series Serial Communications Units	W494

Event code	Event name	Functional classification	Reference
64A30000 hex	FCS Check Error	CJ-series Serial Communications Units	W494
64A40000 hex	Timeout Error	CJ-series Serial Communications Units	W494
64A50000 hex	Comparison Error	CJ-series Serial Communications Units	W494
64A60000 hex	Reception Overflow	CJ-series Serial Communications Units	W494
64A70000 hex	Command Format Error	CJ-series Serial Communications Units	W494
64AC0000 hex	Send Timeout Error	CJ-series DeviceNet Units	W497
64CC0000 hex	I/O Disconnection Detected	Block I/O (GX-series EtherCAT Slave Units)	W488
64E00000 hex	Drive Prohibition Input Error 1	G5-series Servo Drives with Built-in EtherCAT Communications	I576
64E10000 hex	Drive Prohibition Input Error 2	G5-series Servo Drives with Built-in EtherCAT Communications	I576
64E20000 hex	Immediate Stop Input Error	G5-series Servo Drives with Built-in EtherCAT Communications	I576
68010000 hex	Unit Error	CJ-series High-speed Counter Units	W492
74200000 hex	Motion Control Period Exceeded	General Motion Control	W507
74210000 hex	Servo Main Circuit Power OFF	General Motion Control	W507
74220000 hex	Servo Main Circuits OFF	Motion Control Instructions	W508
74230000 hex	Interrupt Feeding Interrupt Signal Missing	General Motion Control	W507
74240000 hex	Homing Opposite Direction Limit Input Detected	General Motion Control	W507
74250000 hex	Homing Direction Limit Input Detected	General Motion Control	W507
74260000 hex	Homing Limit Inputs Detected in Both Directions	General Motion Control	W507
74270000 hex	Home Proximity/Homing Opposite Direction Limit Input Detected	General Motion Control	W507
74280000 hex	Home Proximity/Homing Direction Limit Input Detected	General Motion Control	W507
74290000 hex	Home Input/Homing Opposite Direction Limit Input Detected	General Motion Control	W507
742A0000 hex	Home Input/Homing Direction Limit Input Detected	General Motion Control	W507
742B0000 hex	Invalid Home Input Mask Distance	General Motion Control	W507
742C0000 hex	No Home Input	General Motion Control	W507
742D0000 hex	No Home Proximity Input	General Motion Control	W507
742F0000 hex	Slave Error Detected	General Motion Control	W507
74300000 hex	Axes Group Composition Axis Error	General Motion Control	W507
74320000 hex	Slave Observation Detected	General Motion Control	W507
74330000 hex	MC Common Error Occurrence	General Motion Control	W507
74340000 hex	Latch Position Overflow	General Motion Control	W507
74350000 hex	Latch Position Underflow	General Motion Control	W507
74360000 hex	Master Sync Direction Error	General Motion Control	W507
74370000 hex	Slave Disconnection during Servo ON	General Motion Control	W507

Event code	Event name	Functional classification	Reference
74380000 hex	Feed Distance Overflow	General Motion Control	W507
74390000 hex	Error in Changing Servo Drive Control Mode	General Motion Control	W507
743A0000 hex	Master Axis Position Read Error	General Motion Control	W507
743B0000 hex	Auxiliary Axis Position Read Error	General Motion Control	W507
743C0000 hex	Cannot Execute Save Cam Table Instruction	General Motion Control	W507
74600000 hex	Master Function Enable/Disable Failed	CJ-series DeviceNet Units	W497
74610000 hex	Master Fixed Allocation Area Setting Failed	CJ-series DeviceNet Units	W497
74620000 hex	Scan List Register/Clear Failed	CJ-series DeviceNet Units	W497
74630000 hex	Slave Function Enable/Disable Failed	CJ-series DeviceNet Units	W497
74640000 hex	Slave Fixed Allocation Area Setting Failed	CJ-series DeviceNet Units	W497
74800000 hex	Command Warning	G5-series Servo Drives with Built-in EtherCAT Communications	I576
74810000 hex	Command Error	G5-series Servo Drives with Built-in EtherCAT Communications	I576
78010000 hex	Operation Command Competition	G5-series Servo Drives with Built-in EtherCAT Communications	I576
78020000 hex	Absolute Encoder Status Error	G5-series Servo Drives with Built-in EtherCAT Communications	I576
78080000 hex	TRIG Input Error	EtherCAT FQ-M-series Specialized Vision Sensors for Positioning	Z314
780A0000 hex	Scene Data Error	EtherCAT FQ-M-series Specialized Vision Sensors for Positioning	Z314
780B0000 hex	Model Error	EtherCAT FQ-M-series Specialized Vision Sensors for Positioning	Z314
780C0000 hex	Logging Error	EtherCAT FQ-M-series Specialized Vision Sensors for Positioning	Z314
780D0000 hex	Output Timeout	EtherCAT FQ-M-series Specialized Vision Sensors for Positioning	Z314
780E0000 hex	Output Size Error	EtherCAT FQ-M-series Specialized Vision Sensors for Positioning	Z314
80010000 hex	Illegal Packet Discarded	Errors Related to Unit Configuration	W500
80100000 hex	Packet Discarded	Errors Related to FINS Communications	W501
80110000 hex	Packet Discarded	Errors Related to FINS Communications	W501
80120000 hex	Packet Discarded	Errors Related to FINS Communications	W501
84010000 hex	IP Address Duplication Error	Built-in EtherNet/IP Port on CPU Unit and CJ-series EtherNet/IP Units	W506 and W495
84020000 hex	BOOTP Server Connection Error	Built-in EtherNet/IP Port on CPU Unit and CJ-series EtherNet/IP Units	W506 and W495
84030000 hex	DNS Server Connection Error	Built-in EtherNet/IP Port on CPU Unit	W506
84040000 hex	NTP Server Connection Error	Built-in EtherNet/IP Port on CPU Unit	W506
84050000 hex	Packet Discarded Due to Full Reception Buffer	Built-in EtherNet/IP Port on CPU Unit	W506
84060000 hex	Link OFF Detected	Built-in EtherNet/IP Port on CPU Unit	W506

Event code	Event name	Functional classification	Reference
84070000 hex	Tag Data Link Connection Failed	Built-in EtherNet/IP Port on CPU Unit and CJ-series EtherNet/IP Units	W506 and W495
84080000 hex	Tag Data Link Timeout	Built-in EtherNet/IP Port on CPU Unit	W506
84200000 hex	Link OFF Error	Built-in EtherCAT Master in CPU Unit	W505
84210000 hex	Network Configuration Error	Built-in EtherCAT Master in CPU Unit	W505
842200000 hex	Network Configuration Verification Error	Built-in EtherCAT Master in CPU Unit	W505
84230000 hex	Slave Initialization Error	Built-in EtherCAT Master in CPU Unit	W505
84280000 hex	Slave Application Error	Built-in EtherCAT Master in CPU Unit	W505
84290000 hex	Process Data Transmission Error	Built-in EtherCAT Master in CPU Unit	W505
842B0000 hex	Process Data Reception Timeout	Built-in EtherCAT Master in CPU Unit	W505
842C0000 hex	Process Data Communications Error	Built-in EtherCAT Master in CPU Unit	W505
842D0000 hex	EtherCAT Message Error	Built-in EtherCAT Master in CPU Unit	W505
84400000 hex	EtherCAT Slave Communications Error	General Motion Control	W507
84680000 hex	Transmission Error	CJ-series Serial Communications Units	W494
84690000 hex	Overrun Error	CJ-series Serial Communications Units	W494
846A0000 hex	Framing Error	CJ-series Serial Communications Units	W494
846B0000 hex	Parity Error	CJ-series Serial Communications Units	W494
846C0000 hex	Overrun Error, Framing Error, or Parity Error (Transmission Error)	CJ-series Serial Communications Units	W494
846D0000 hex	Transmission Error (CRC Error)	CJ-series Serial Communications Units	W494
84740000 hex	Bus Off Detected	CJ-series DeviceNet Units	W497
84750000 hex	Remote I/O Communications Error	CJ-series DeviceNet Units	W497
84760000 hex	Remote I/O Communications Error (during Slave Operation)	CJ-series DeviceNet Units	W497
84770000 hex	Slave COS Send Failed	CJ-series DeviceNet Units	W497
84B00000 hex	EtherCAT Communications Warning	G5-series Servo Drives with Built-in EtherCAT Communications	I576
84B10000 hex	EtherCAT State Change Error	G5-series Servo Drives with Built-in EtherCAT Communications	I576
84B20000 hex	EtherCAT Illegal State Change Error	G5-series Servo Drives with Built-in EtherCAT Communications	I576
84B30000 hex	Communications Synchronization Error	G5-series Servo Drives with Built-in EtherCAT Communications	I576
84B40000 hex	Synchronization Error	G5-series Servo Drives with Built-in EtherCAT Communications	I576
84B50000 hex	Sync Manager WDT Error	G5-series Servo Drives with Built-in EtherCAT Communications	I576
84B60000 hex	ESC Initialization Error	G5-series Servo Drives with Built-in EtherCAT Communications	I576
84B70000 hex	Slave Unit Verification Error	G5-series Servo Drives with Built-in EtherCAT Communications	I576
84B80000 hex	Communications Setting Error	G5-series Servo Drives with Built-in EtherCAT Communications	I576

Event code	Event name	Functional classification	Reference
84B90000 hex	Synchronization Interruption Error	G5-series Servo Drives with Built-in EtherCAT Communications	I576
90010000 hex	Clock Changed	Errors Related to Controller Operation	W500, W501
90020000 hex	Time Zone Changed	Errors Related to Controller Operation	W500, W501
90080000 hex	Variable Changed to TRUE with Forced Refreshing	Errors Related to Controller Operation	W500, W501
90090000 hex	Variable Changed to FALSE with Forced Refreshing	Errors Related to Controller Operation	W500, W501
900A0000 hex	All Forced Refreshing Cleared	Errors Related to Controller Operation	W500, W501
900B0000 hex	Memory All Cleared	Errors Related to Controller Operation	W500, W501
900C0000 hex	Event Log Cleared	Errors Related to Controller Operation	W500, W501
90110000 hex	Power Turned ON	Errors Related to Controller Operation	W500, W501
90120000 hex	Power Interrupted	Errors Related to Controller Operation	W500, W501
90130000 hex	Operation Started	Errors Related to Controller Operation	W500, W501
90140000 hex	Operation Stopped	Errors Related to Controller Operation	W500, W501
90150000 hex	Reset Executed	Errors Related to Controller Operation	W500, W501
90160000 hex	User Program Execution ID Write	Errors Related to Controller Operation	W500, W501
90180000 hex	All Controller Errors Cleared	Errors Related to Controller Operation	W500, W501
90190000 hex	Forced Refreshing Cleared	Errors Related to Controller Operation	W500, W501
94010000 hex	Tag Data Link Download Started	Built-in EtherNet/IP Port on CPU Unit	W506
94020000 hex	Tag Data Link Download Finished	Built-in EtherNet/IP Port on CPU Unit	W506
94030000 hex	Tag Data Link Stopped	Built-in EtherNet/IP Port on CPU Unit	W506
94040000 hex	Tag Data Link Started	Built-in EtherNet/IP Port on CPU Unit	W506
94050000 hex	Link Detected	Built-in EtherNet/IP Port on CPU Unit	W506
94060000 hex	Restarting Ethernet Port	Built-in EtherNet/IP Port on CPU Unit	W506
94070000 hex	Tag Data Link All Run	Built-in EtherNet/IP Port on CPU Unit	W506
94080000 hex	IP Address Fixed	Built-in EtherNet/IP Port on CPU Unit	W506
94090000 hex	BOOTP Client Started	Built-in EtherNet/IP Port on CPU Unit	W506
940A0000 hex	FTP Server Started	Built-in EtherNet/IP Port on CPU Unit	W506
940B0000 hex	NTP Client Started	Built-in EtherNet/IP Port on CPU Unit	W506
940C0000 hex	SNMP Started	Built-in EtherNet/IP Port on CPU Unit	W506
94200000 hex	Notice of Insufficient Travel Distance to Achieve Blending Transit Velocity	General Motion Control	W507
94210000 hex	Error Clear from MC Test Run Tab Page	General Motion Control	W507
94220000 hex	Slave Error Code Report	General Motion Control	W507
94400000 hex	Slave Disconnected	Built-in EtherCAT Master in CPU Unit	W505
94410000 hex	Slave Connected	Built-in EtherCAT Master in CPU Unit	W505

Event code	Event name	Functional classification	Reference
94430000 hex	Errors Reset	Built-in EtherCAT Master in CPU Unit	W505
98010000 hex	Absolute Value Cleared	G5-series Servo Drives with Built-in EtherCAT Communications	I576
98020000 hex	Position Data Initialized	G5-series Servo Drives with Built-in EtherCAT Communications	I576

3-3 Instruction Error Table

This section provides a table of errors that occur for instructions. Notification is not provided for errors that occur for instructions other than motion control instructions.

Notification is provided for errors that occur in motion control instructions. Refer to *3-1-3 Errors in the Motion Control Function Module*.

3-3-1 Interpreting Error Descriptions

The contents of the error tables are described below.

Item	Description
Error code	The code of the error that occurs for the instruction is given. The codes are given in four hexadecimal digits.
Name	The name of the error is given.
Meaning	A short description of the error code is given.
Cause	The assumed cause of the error is given
Reference	The name and catalog number of the manual that provides details on the error are given.

A version in parentheses in the *Error code* column is the unit version of the CPU Unit when the error code was added.

Refer to the manual given in the *Reference* column in the table for detailed information on an error.

3-3-2 Error Table

Error code	Name	Meaning	Assumed cause	Reference
16#0400	Input Value Out of Range	An input parameter for an instruction exceeded the valid range for an input variable. Or, division by an integer of 0 occurred in division or remainder calculations.	<ul style="list-style-type: none"> An input parameter for an instruction exceeded the valid range for an input variable. Or, division by an integer of 0 occurred in division or remainder calculations. 	NJ-series Instructions Reference Manual (Cat. No. W502)
16#0401	Input Mismatch	The relationship for the instruction input parameters did not meet required conditions. Or, a numeric value during or after instruction execution did not meet conditions.	<ul style="list-style-type: none"> The relationship for an input parameter did not meet required conditions. A value when processing an instruction or in the result does not meet the conditions. 	Same as above.
16#0402	Floating-point Error	Non-numeric data was input for a floating-point number input parameter to an instruction.	<ul style="list-style-type: none"> Non-numeric data was input for a floating-point number input parameter to an instruction. 	Same as above.
16#0403	BCD Error	A value that was not BCD was input for a BCD input parameter to an instruction.	<ul style="list-style-type: none"> A hexadecimal digit of A, B, C, D, E, or F was input for a BCD input parameter to an instruction. 	Same as above.

Error code	Name	Meaning	Assumed cause	Reference
16#0404	Signed BCD Error	An illegal value was input for the most significant digit for a signed BCD input parameter to an instruction.	<ul style="list-style-type: none"> An illegal value was input for the most significant digit for a signed BCD input parameter to an instruction. The most-significant digit was 2 to F when <code>_BCD0</code> was specified as the BCD format. The most-significant digit was A, B, C, D, or E when <code>_BCD2</code> was specified as the BCD format. The most-significant digit was B, C, D, or E when <code>_BCD3</code> was specified as the BCD format. 	NJ-series Instructions Reference Manual (Cat. No. W502)
16#0405	Illegal Bit Position Specified	The bit position specified for an instruction was illegal.	<ul style="list-style-type: none"> The bit position specified for an instruction exceeds the data range. 	Same as above.
16#0406	Illegal Data Position Specified	The data position specified for an instruction exceeded the data area range.	<ul style="list-style-type: none"> The data position or data size specified for an instruction exceeded the data area range. 	Same as above.
16#0407	Data Range Exceeded	The results of instruction processing exceeded the data area range of the output parameter.	<ul style="list-style-type: none"> The results of instruction processing, such as the number of array elements, exceeded the data area range of the output parameter. 	Same as above.
16#0409	No Errors to Clear	An instruction to clear a Controller error was executed when there was no error in the Controller.	<ul style="list-style-type: none"> An instruction to clear a Controller error was executed when there was no error in the Controller. 	Same as above.
16#040B	No User Errors to Clear	An instruction to clear user-defined errors was executed when there was no user-defined error.	<ul style="list-style-type: none"> An instruction to clear user-defined errors was executed when there was no user-defined error. 	Same as above.
16#040C	Limit Exceeded for User-defined Errors	An attempt was made to use the Create User-defined Error instruction to create more than the maximum number of user-defined errors.	<ul style="list-style-type: none"> An attempt was made to use the Create User-defined Error instruction to create more than the maximum number of user-defined errors. 	Same as above.
16#040D	Illegal Unit Specified	The Unit specified for an instruction does not exist.	<ul style="list-style-type: none"> A Unit that does not exist in the Unit configuration information was specified. A Unit that is in the Unit configuration information was specified, but the Units does not actually exist in the Controller. 	Same as above.
16#040F	Unit Restart Failed	Restarting a Special I/O Unit or CPU Bus Unit failed.	<ul style="list-style-type: none"> The Special I/O Unit or CPU Bus Unit is processing data. 	Same as above.
16#0410	Text String Format Error	The text string input to an instruction is not correct.	<ul style="list-style-type: none"> The text string that is input to the instruction for conversion to a number does not represent a number or it does not represent a positive number. The input text string does not end in NULL. 	Same as above.
16#0411	Illegal Program Specified	The program specified for an instruction does not exist.	<ul style="list-style-type: none"> The program specified by the function does not exist (e.g., it was deleted). 	Same as above.
16#0413	Undefined CJ-series Memory Address	The required specification is missing for a variable for which CJ-series Unit memory must be specified.	<ul style="list-style-type: none"> The required AT specification is missing for a variable for which CJ-series Unit memory must be specified. 	Same as above.
16#0414	Stack Underflow	There is no data in a stack.	<ul style="list-style-type: none"> An attempt was made to read data from a stack that contains no data. 	Same as above.
16#0416	Illegal Number of Array Elements or Dimensions	The valid range was exceeded for the number of array elements or dimensions in an array I/O parameter for an instruction.	<ul style="list-style-type: none"> The valid range was exceeded for the number of array elements or dimensions in an array I/O parameter for an instruction. 	Same as above.
16#0417	Specified Task Does Not Exist	The task specified for the instruction does not exist.	<ul style="list-style-type: none"> The specified task does not exist. 	Same as above.

Error code	Name	Meaning	Assumed cause	Reference
16#0418	Unallowed Task Specification	An unallowed task was specified for an instruction.	<ul style="list-style-type: none"> The local task, the primary periodic task, or a periodic task was specified. 	NJ-series Instructions Reference Manual (Cat. No. W502)
16#0419	Incorrect Data Type	A data type that cannot be used for an instruction is specified for an input or in-out variable.	<ul style="list-style-type: none"> A data type that cannot be used for an instruction is specified for an input or in-out variable. 	Same as above.
16#041A	Multi-execution of Instructions	Multi-execution was specified for an instruction that does not support it.	<ul style="list-style-type: none"> Execution of an instruction that does not support multi-execution of instructions was specified more than once. 	Same as above.
16#0800	FINS Error	An error occurred when a FINS command was sent or received.	<ul style="list-style-type: none"> An error occurred when a FINS command was sent or received. 	Same as above.
16#0801	FINS Port Already in Use	The FINS port is being used.	<ul style="list-style-type: none"> The FINS port is being used. 	Same as above.
16#0C00	Illegal Serial Communications Mode	The Serial Communications Unit is not in the serial communications mode required to execute an instruction.	<ul style="list-style-type: none"> The serial communications port for the Serial Communications Unit is not set to the mode expected by the instruction. 	Same as above.
16#0C02	Port Setup Already Busy	A Change Port Setup instruction was executed during execution of another Change Port Setup instruction.	<ul style="list-style-type: none"> A Change Port Setup instruction was executed during execution of another Change Port Setup instruction. 	Same as above.
16#1400	SD Memory Card Access Failure	SD Memory Card access failed when an instruction was executed.	<ul style="list-style-type: none"> An SD Memory Card is either not inserted or is not inserted properly. The SD Memory Card is broken. The SD Memory Card slot is broken. 	Same as above.
16#1401	SD Memory Card Write-protected	An attempt was made to write to a write-protected SD Memory Card when an instruction was executed.	<ul style="list-style-type: none"> An attempt was made to write to a write-protected SD Memory Card. 	Same as above.
16#1402	SD Memory Card Insufficient Capacity	The capacity of the SD Memory Card was insufficient when writing to the SD Memory Card for an instruction.	<ul style="list-style-type: none"> The SD Memory Card has run out of free space. 	Same as above.
16#1403	File Does Not Exist	The file specified for an instruction does not exist.	<ul style="list-style-type: none"> The specified file does not exist. 	Same as above.
16#1404	Too Many Files/Directories	The maximum number of files/directories was exceeded when creating a file/directory for an instruction.	<ul style="list-style-type: none"> The number of files or directories exceeded the maximum number. 	Same as above.
16#1405	File Already in Use	A file specified for an instruction cannot be accessed because it is already being used.	<ul style="list-style-type: none"> An instruction attempted to read or write a file already being accessed by another instruction. 	Same as above.
16#1406	Open Mode Mismatch	A file operation for an instruction was inconsistent with the open mode of the file.	<ul style="list-style-type: none"> The file open mode specified by the Open File instruction does not match the file operation attempted by a subsequent SD Memory Card instruction. 	Same as above.
16#1407	Offset Out of Range	Access to the address is not possible for the offset specified for an instruction.	<ul style="list-style-type: none"> An attempt was made to access beyond the size of the file. 	Same as above.

Error code	Name	Meaning	Assumed cause	Reference
16#1408	Directory Not Empty	A directory was not empty when the Delete Directory instruction was executed or when an attempt was made to change the directory name.	<ul style="list-style-type: none"> A directory was not empty when the Delete Directory instruction was executed. A directory contained another directory when an attempt was made to change the directory name. 	NJ-series Instructions Reference Manual (Cat. No. W502)
16#1409	That File Name Already Exists	An instruction could not be executed because the file name specified for the instruction already exists.	<ul style="list-style-type: none"> A file already exists with the same name as the name specified for the instruction to create. 	Same as above.
16#140A	Write Access Denied	An attempt was made to write to a write-protected file or directory when an instruction was executed.	<ul style="list-style-type: none"> The file or directory specified for the instruction to write is write-protected. 	Same as above.
16#140B	Too Many Files Open	The maximum number of open files was exceeded when opening a file for an instruction.	<ul style="list-style-type: none"> The maximum number of open files was exceeded when opening a file for an instruction. 	Same as above.
16#140C	Directory Does Not Exist	The directory specified for an instruction does not exist.	<ul style="list-style-type: none"> The directory specified for an instruction does not exist. 	Same as above.
16#140D	File or Directory Name Is Too Long	The file name or directory name that was specified for an instruction is too long.	<ul style="list-style-type: none"> The file name or directory name that was specified for the instruction to create is too long. 	Same as above.
16#140E	SD Memory Card Access Failed	SD Memory Card access failed.	<ul style="list-style-type: none"> The SD Memory Card is broken. The SD Memory Card slot is broken. 	Same as above.
16#1800	EtherCAT Communications Error	Accessing the EtherCAT network failed when an instruction was executed.	<ul style="list-style-type: none"> The EtherCAT network is not in a usable status. 	Same as above.
16#1801	EtherCAT Slave Does Not Respond	Accessing the target slave failed when an instruction was executed.	<ul style="list-style-type: none"> The target slave does not exist. The target slave is not in an operating condition. 	Same as above.
16#1802	EtherCAT Timeout	A timeout occurred while trying to access an EtherCAT slave when an instruction was executed.	<ul style="list-style-type: none"> Communications with the target slave timed out. 	Same as above.
16#1803	Reception Buffer Overflow	The receive data from an EtherCAT slave overflowed the receive buffer when an instruction was executed.	<ul style="list-style-type: none"> The receive data from the slave overflowed the receive buffer. 	Same as above.
16#1804	SDO Abort Error	An SDO abort error was received from an EtherCAT slave when an instruction was executed.	<ul style="list-style-type: none"> Depends on the specifications of the slave. 	Same as above.
16#1805	Saving Packet Monitor File	An instruction for packet monitoring was executed while saving an EtherCAT packet monitor file.	<ul style="list-style-type: none"> An instruction for packet monitoring was executed while saving an EtherCAT packet monitor file. 	Same as above.
16#1806	Packet Monitoring Function Not Started	A Stop EtherCAT Packet Monitor instruction was executed when EtherCAT packet monitoring was stopped.	<ul style="list-style-type: none"> A Stop EtherCAT Packet Monitor instruction was executed when EtherCAT packet monitoring was stopped. 	Same as above.
16#1807	Packet Monitoring Function in Operation	A Start EtherCAT Packet Monitor instruction was executed when EtherCAT packet monitoring was already being executed.	<ul style="list-style-type: none"> The Start EtherCAT Packet Monitor instruction was executed again while the EtherCAT packet monitoring function was already in operation. 	Same as above.

Error code	Name	Meaning	Assumed cause	Reference
16#1808	Communications Resource Overflow	More than 32 EtherCAT communications instructions were executed at the same time.	<ul style="list-style-type: none"> • More than 32 EtherCAT communications instructions were executed at the same time. The EtherCAT communications instructions are listed below. • EC_CoESDOWrite instruction • EC_CoESDORead instruction • EC_ConnectSlave instruction • EC_DisconnectSlave instruction • EC_StartMon instruction • EC_SaveMon instruction • EC_StopMon instruction • EC_CopyMon instruction 	NJ-series Instructions Reference Manual (Cat. No. W502)
16#1809 (Ver. 1.01)	Packet Monitoring Function Not Supported	Packets cannot be monitored.	<ul style="list-style-type: none"> • An instruction for packet monitoring was executed for a CPU Unit that does not support packet monitoring. 	Same as above.
16#1C00	Explicit Message Error	An error response code was returned for an explicit message that was sent with a CIP communications instruction.	<ul style="list-style-type: none"> • Depends on the nature of the error. 	Same as above.
16#1C01	Incorrect Route Path	The format of the route path that is specified for a CIP communications instruction is not correct.	<ul style="list-style-type: none"> • The format of the route path that is specified for a CIP communications instruction is not correct. 	Same as above.
16#1C02	CIP Handle Out of Range	The handle that is specified for the CIP communications instruction is not correct.	<ul style="list-style-type: none"> • The handle that is specified for the CIP communications instruction is not correct. 	Same as above.
16#1C03	CIP Communications Resource Overflow	The maximum resources that you can use for CIP communications instructions at the same time was exceeded.	<ul style="list-style-type: none"> • More than 32 CIP communications instructions were executed at the same time. • An attempt was made to use more than 32 handles at the same time. 	Same as above.
16#1C04	CIP Timeout	A CIP timeout occurred during execution of a CIP communications instruction.	<ul style="list-style-type: none"> • A device does not exist for the specified IP address. • The CIP connection for the specified handle timed out and was closed. • Power to the remote device is OFF. • Communications are stopped at the remote device. • The Ethernet cable connector for Ethernet/IP is disconnected. • The Ethernet cable for Ethernet/IP is disconnected. • Noise 	Same as above.
16#2000	Local IP Address Setting Error	An instruction was executed when there was a setting error in the local IP address.	<ul style="list-style-type: none"> • An instruction was executed when there was a setting error in the local IP address. 	Same as above.
16#2001	TCP/UDP Port Already in Use	The UDP or TCP port was already in use when the instruction was executed.	<ul style="list-style-type: none"> • The UDP or TCP port is already in use. 	Same as above.
16#2002	Address Resolution Failed	Address resolution failed for a remote node with the domain name that was specified in the instruction.	<ul style="list-style-type: none"> • The domain name specified for the instruction is not correct. • The hosts and DNS settings in the Controller are incorrect. • The DNS server settings are incorrect. 	Same as above.

Error code	Name	Meaning	Assumed cause	Reference
16#2003	Status Error	The status was not suitable for execution of the instruction.	<ul style="list-style-type: none"> • SktUDPRcv Instruction <ul style="list-style-type: none"> • The socket is receiving data. • The socket is not open. • SktUDPSend Instruction <ul style="list-style-type: none"> • The socket is sending data. • The socket is not open. • SktTCPAccept Instruction <ul style="list-style-type: none"> • The specified TCP port is in one of the following states. <ul style="list-style-type: none"> • The port is being opened. • The port is being closed. • A connection is already established for this instruction for the same IP address and TCP port. • SktTCPConnect Instruction <ul style="list-style-type: none"> • The TCP port that is specified with the <i>SrcTcpPort</i> input variable is already open. • The remote node that is specified with <i>DstAdr</i> input variable does not exist. • The remote node that is specified with <i>DstAdr</i> and <i>DstTcpPort</i> input variables is not waiting for a connection. • SktTCPRcv Instruction <ul style="list-style-type: none"> • The specified socket is receiving data. • The specified socket is not connected. • SktTCPSend Instruction <ul style="list-style-type: none"> • The specified socket is sending data. • The specified socket is not connected. 	NJ-series Instructions Reference Manual (Cat. No. W502)
16#2004	Local IP Address Not Set	The local IP address was not set when a socket service instruction was executed.	<ul style="list-style-type: none"> • There is a BOOTP server setting error. • The BOOTP server does not exist. • The local IP address is not set because operation just started. 	Same as above.
16#2006	Socket Timeout	A timeout occurred for a socket service instruction.	<ul style="list-style-type: none"> • SktTCPAccept instruction: There was no request for a connection from the remote node during the user-set timeout time. • SktTCPRcv or SktUDPRcv instruction: Data was not received from the remote node during the user-set timeout time. 	Same as above.
16#2007	Socket Handle Out of Range	The handle that is specified for the socket service instruction is not correct.	<ul style="list-style-type: none"> • The handle that is specified for the socket service instruction is not correct. 	Same as above.
16#2008	Socket Communications Resource Overflow	The maximum resources that you can use for socket service instructions at the same time was exceeded.	<ul style="list-style-type: none"> • More than 17 socket service communications instructions were executed at the same time. • An attempt was made to use more than 16 socket handles at the same time. 	Same as above.



Index



Index

A

assumed causes 3-3, 3-5, 3-11, 3-37, 3-41, 3-44, 3-45,
..... 3-57, 3-58, 3-60, 3-62, 3-63, 3-65, 3-66, 3-72

B

Block I/O 3-44
built-in EtherCAT master 3-41
built-in EtherNet/IP port 3-37

C

CJ1W-AD041-V1/AD081-V1 3-60
CJ1W-AD042 3-60
CJ1W-AD04U 3-62
CJ1W-CT021 3-65
CJ1W-DA021/DA041 3-60
CJ1W-DA042V 3-60
CJ1W-DA08V/DA08C 3-60
CJ1W-DRM21 3-72
CJ1W-MAD42 3-60
CJ1W-PDC15 3-62
CJ1W-PH41U 3-62
CJ1W-SCU2 3-66
CJ1W-SCU32 3-66
CJ1W-SCU42 3-66
CJ1W-TC003 3-63
CJ1W-TC004 3-63
CJ1W-TC103 3-63
CJ1W-TC104 3-63
CJ1W-V680C11 3-63
CJ1W-V680C12 3-63
CJ-series Analog I/O Units 3-60
CJ-series DeviceNet Units 3-72
CJ-series High-speed Counter Units 3-65
CJ-series ID Sensor Units 3-63
CJ-series Process I/O Units 3-62
CJ-series Serial Communications Units 3-66
CJ-series Temperature Control Units 3-63
CJ-series Units 3-60
Controller errors 1-6
Controller events 1-5
 sources 1-6
Controller information 1-6
Controller operation 3-7
CPU Unit operating status 1-3
CPU Unit Reset 1-4, 2-4
CPU Unit Watchdog Timer Error 1-4, 2-4

E

Error Status variable 1-13, 2-13
errors

 checking with system-defined variables 2-13
 identifying and resetting 2-5, 2-9, 2-11
 resetting 2-12
EtherCAT Master Function Module 3-41
EtherCAT slaves 3-44
EtherNet/IP Function Module 3-37
event codes 1-10, 3-3, 3-5, 3-11, 3-37, 3-41, 3-44, 3-45,
 3-57, 3-58, 3-60, 3-62, 3-63, 3-65, 3-66, 3-72, 3-80
 event codes in sequential order 3-79
event log 1-5
event names ... 3-3, 3-5, 3-11, 3-37, 3-41, 3-44, 3-45, 3-57,
 3-58, 3-60, 3-62, 3-63, 3-65, 3-66, 3-72, 3-80
events 1-2, 1-5
 levels 1-6

F

fatal errors 1-2, 1-4
 checking for fatal errors 1-4
 troubleshooting 2-4
FINS communications 3-9

G

G5-series Servo Drives 3-45
GX-series EtherCAT Slave Units 3-44

I

Incorrect Power Supply Unit Connected 1-4, 2-4
indicators 1-3, 1-11
information level 1-7
instructions
 GetCJBError 1-13, 2-11
 GetECError 1-13, 2-11
 GetEIPError 1-13, 2-11
 GetMCError 1-13, 2-11
 GetPLCError 1-13, 2-11
 getting error information 2-11
 reading function module error status 1-13
 ResetCJBError 2-12
 ResetECError 2-12
 ResetMCError 2-12
 ResetPLCError 2-12

M

major fault level 1-6, 1-9
minor fault level 1-6
motion control
 general 3-11
 instructions 3-19
Motion Control Function Module 3-11
MX2-series Inverters 3-57

N

non-fatal errors 1-3, 1-5, 1-11
 resetting 1-13
 troubleshooting 2-5

O

observation level 1-6
 online
 troubleshooting problems going online 2-14

P

partial fault level 1-6
 Power Supply Error 1-4, 2-4

R

resetting errors 2-12
 resetting non-fatal errors 1-13

S

Safe Mode 2-19
 self diagnosis 3-3
 source details 1-6
 starting
 Safe Mode 2-19
 system-defined variables 1-13
 checking for errors 2-13

T

tasks 3-6
 Troubleshooter 1-12, 2-9
 troubleshooting 1-12, 2-5
 fatal errors 2-4
 non-fatal errors 2-5

U

Unit configuration 3-5
 user-defined events 1-5

OMRON Corporation Industrial Automation Company

Tokyo, JAPAN

Contact: www.ia.omron.com

Regional Headquarters

OMRON EUROPE B.V.

Wegalaan 67-69-2132 JD Hoofddorp
The Netherlands

Tel: (31)2356-81-300/Fax: (31)2356-81-388

OMRON ELECTRONICS LLC

One Commerce Drive Schaumburg,
IL 60173-5302 U.S.A.

Tel: (1) 847-843-7900/Fax: (1) 847-843-7787

OMRON ASIA PACIFIC PTE. LTD.

No. 438A Alexandra Road # 05-05/08 (Lobby 2),
Alexandra Technopark,
Singapore 119967

Tel: (65) 6835-3011/Fax: (65) 6835-2711

OMRON (CHINA) CO., LTD.

Room 2211, Bank of China Tower,
200 Yin Cheng Zhong Road,
PuDong New Area, Shanghai, 200120, China

Tel: (86) 21-5037-2222/Fax: (86) 21-5037-2200

Authorized Distributor:

© OMRON Corporation 2011 All Rights Reserved.
In the interest of product improvement,
specifications are subject to change without notice.

Cat. No. W503-E1-02

0112