

LOW NOISE AMPLIFIER GaAs MMIC

■GENERAL DESCRIPTION

NJG1107HA8 is a Low Noise Amplifier GaAs MMIC designed for GPS. This amplifier provides low noise figure, high gain and high input IP3 operated by single low positive power supply.

This amplifier includes internal self-bias circuit and input DC blocking capacitor.

This amplifier can be tuned to wide frequency point (1.5GHz~2.4GHz).

An ultra small and ultra thin package of USB6-A8 is adopted.

■PACKAGE OUTLINE

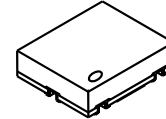

NJG1107HA8

■FEATURES

- | | |
|-----------------------------------|-------------------------------------|
| ●Low voltage operation | +2.7V typ. |
| ●Low current consumption | 2.5mA typ. |
| ●High small signal gain | 17dB typ. @f=1.575GHz |
| ●Low noise figure | 1.1dB typ. @f=1.575GHz |
| ●High Input IP3 | -4.0dBm typ. @f=1.575+1.5751GHz |
| ●Ultra small & ultra thin package | USB6-A8(Mount Size: 1.0x1.2x0.38mm) |

■PIN CONFIGURATION

HA8 Type
(Top View)

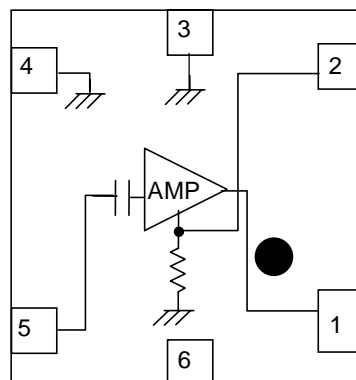

Pin Connection

1. RF_{OUT}
2. EXTCAP
3. GND
4. GND
5. RF_{IN}
6. N/C

Note: Specifications and description listed in this catalog are subject to change without prior notice.

NJG1107HA8

www.DataSheet4U.com

■ABSOLUTE MAXIMUM RATINGS

$T_a=+25^{\circ}\text{C}$, $Z_s=Z_l=50\text{ohm}$

PARAMETER	SYMBOL	CONDITIONS	RATINGS	UNIT
Drain Voltage	V_{DD}		6.0	V
Input Power	Pin	$V_{DD}=2.7\text{V}$	+15	dBm
Power Dissipation	P_D	At on PCB board	135	mW
Operating Temp.	T_{opr}		-40~+85	$^{\circ}\text{C}$
Storage Temp.	T_{stg}		-55~+150	$^{\circ}\text{C}$

■ELECTRICAL CHARACTERISTICS

$V_{DD}=2.7\text{V}$, $f=1.575\text{GHz}$, $T_a=+25^{\circ}\text{C}$, $Z_s=Z_l=50\text{ohm}$, TEST CIRCUIT

PARAMETER	SYMBOL	CONDITIONS	MIN	TYP	MAX	UNIT
Operating Frequency	freq1		1.57	1.575	1.58	GHz
Drain Voltage	V_{DD}		2.5	2.7	5.5	V
Operating Current	I_{DD}	RF OFF	-	2.5	3.2	mA
Small Signal Gain	Gain		15.0	17.0	-	dB
Noise Figure	NF		-	1.1	1.3	dB
Pin at 1dB Gain Compression point	$P_{-1\text{dB}}$		-20.0	-16.0	-	dBm
Input 3rd Order Intercept Point	IIP3	$f=1.575+1.5751\text{GHz}$ $RFin=-35\text{dBm}$	-7.0	-4.0	-	dBm
RF Input Port VSWR	$VSWR_i$		-	1.6	2.0	
RF Output Port VSWR	$VSWR_o$			1.6	2.0	

■PIN CONFIGURATION

Pin	Function	Description
1	Rfout	RF output and voltage supply pin. External matching circuits and a bypass capacitor is required. L3 is a RF choke inductor and C1 is a DC blocking capacitor. These elements are used as output matching circuit. C2 is a bypass capacitor.
2	EXTCAP	An external bypass capacitor is required.
3,4	GND	Ground pin. To keep good RF grounding performance, please use multiple via holes to connect with ground plane and this pin.
5	Rfin	RF input pin. A DC blocking capacitor is not required. An external matching circuit is required.
6	N/C	Neutral terminal. Should be connected to the ground.

NJG1107HA8

www.DataSheet4U.com

TYPICAL CHARACTERISTICS

NF vs. frequency

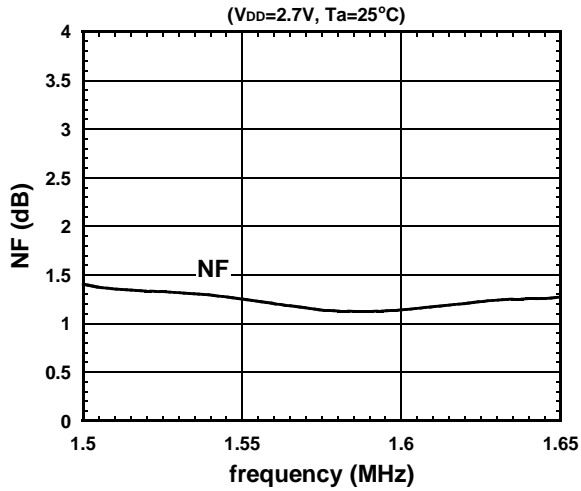

Pout vs. Pin

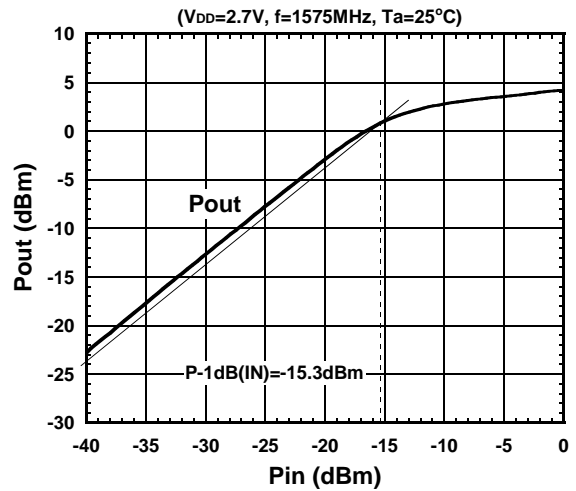

Pout, IM3 vs. Pin

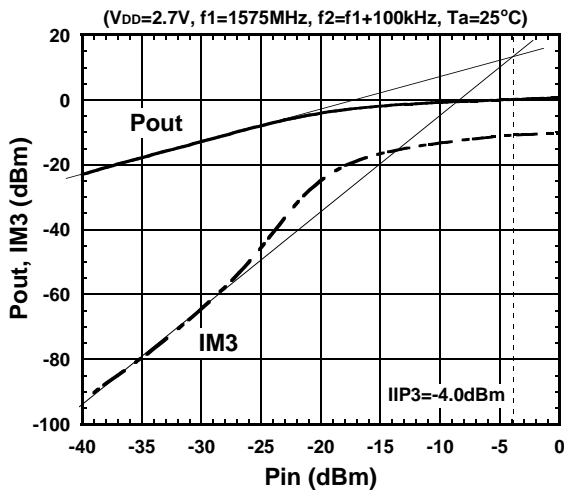

k factor vs. frequency

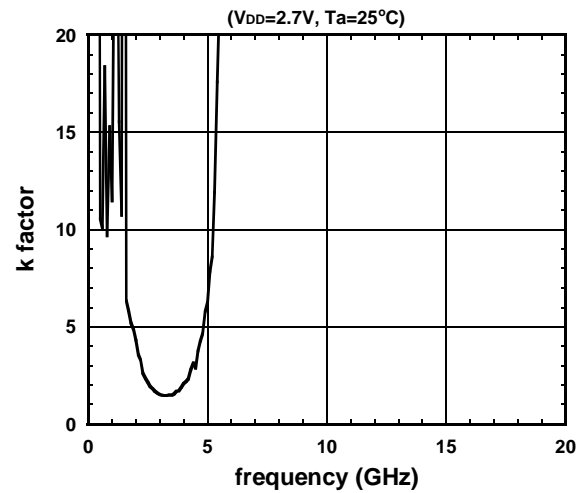

Gain, NF vs. V_{DD}

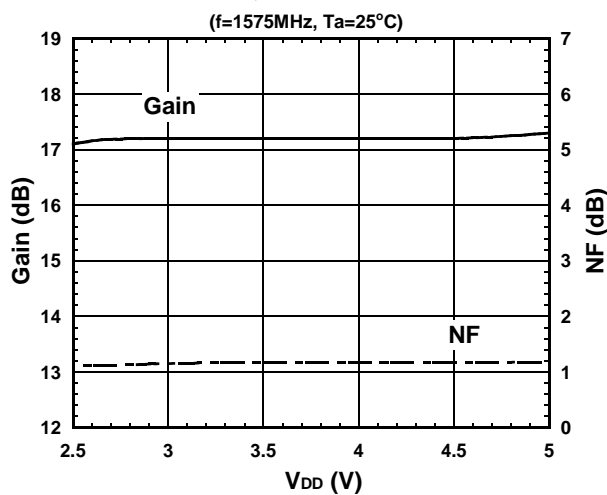

I_{DD} vs. V_{DD}

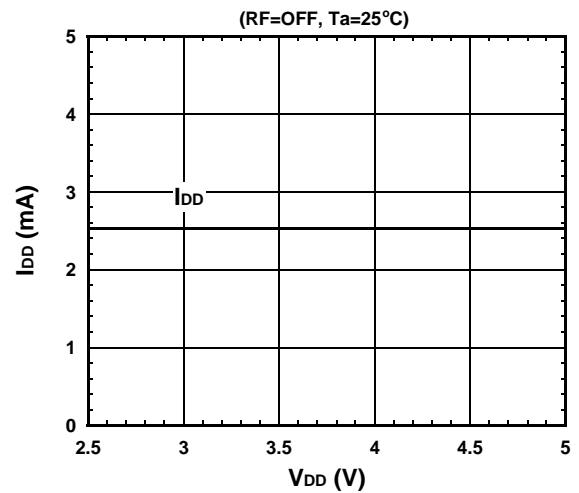

TYPICAL CHARACTERISTICS

P-1dB(IN) vs. V_{DD}

(f=1575MHz, T_a=25°C)

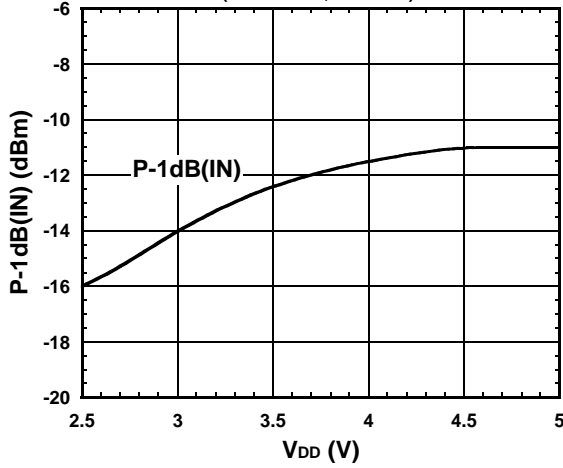

OIP3, IIP3 vs. V_{DD}

(f₁=1575MHz, f₂=f₁+100kHz, Pin=-35dBm, T_a=25°C)

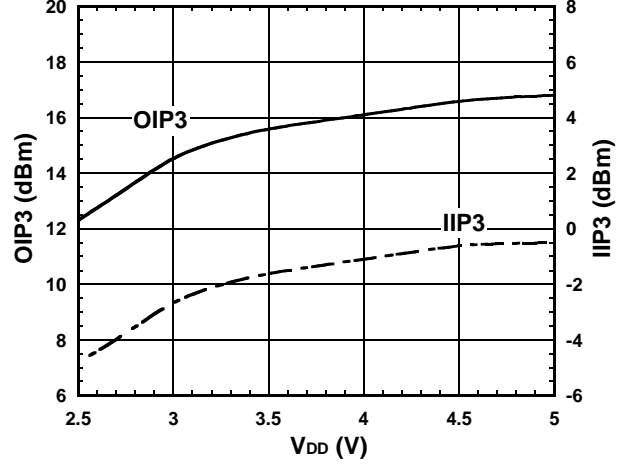

Gain, NF vs. Temperature

(V_{DD}=2.7V, f=1575MHz)

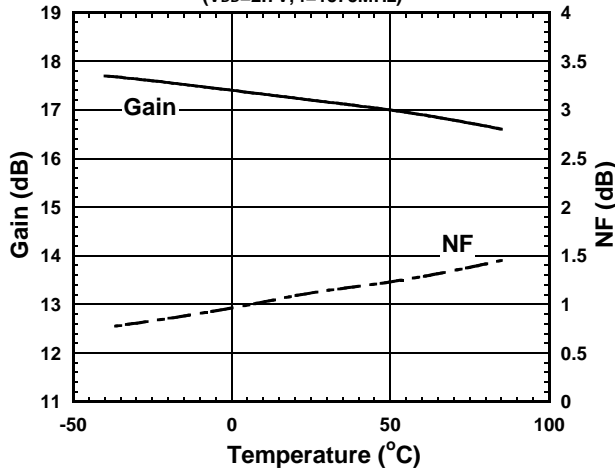

I_{DD} vs. Temperature

(V_{DD}=2.7V, RF=OFF)

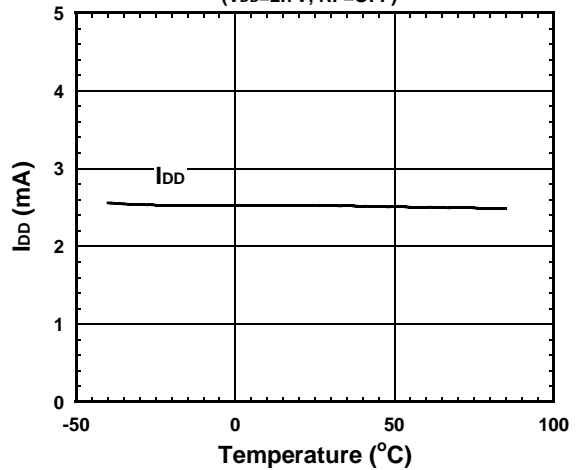

P-1dB(IN) vs. Temperature

(V_{DD}=2.7V, f=1575MHz)

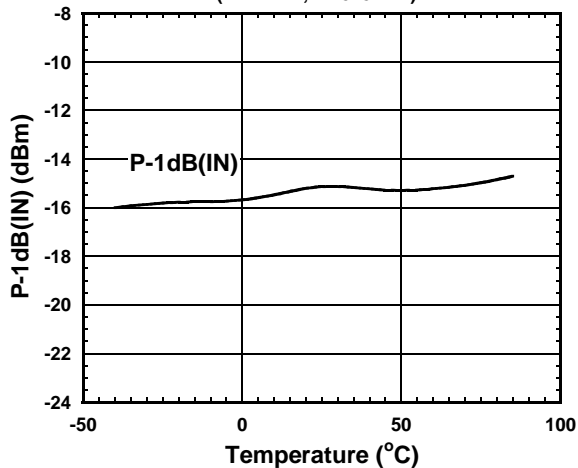

OIP3, IIP3 vs. Temperature

(V_{DD}=2.7V, f₁=1575MHz, f₂=f₁+100kHz, Pin=-35dBm)

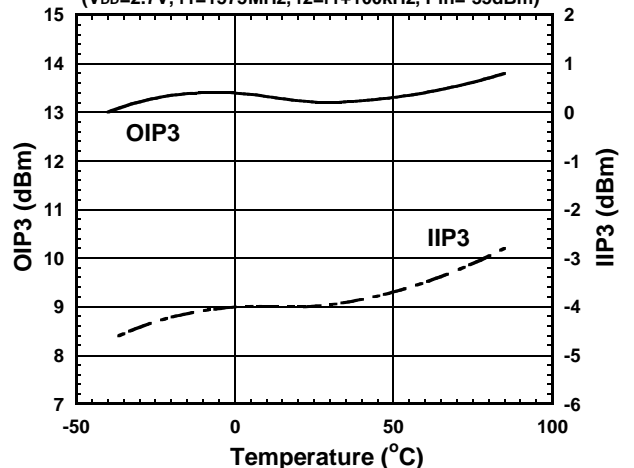

NJG1107HA8

www.DataSheet4U.com

TYPICAL CHARACTERISTICS

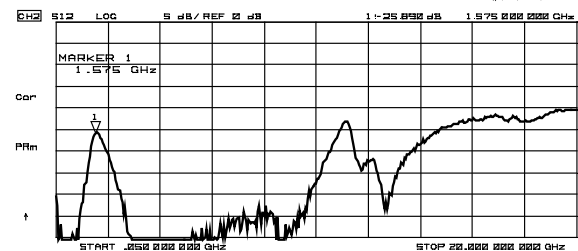
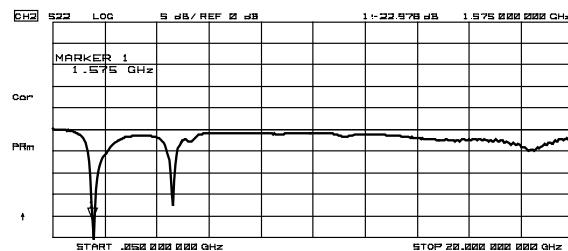
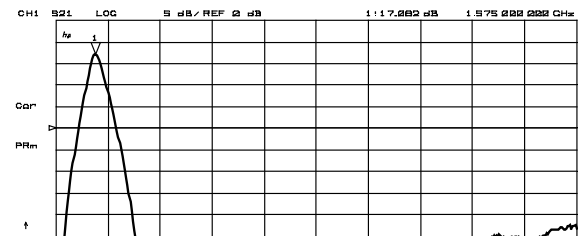
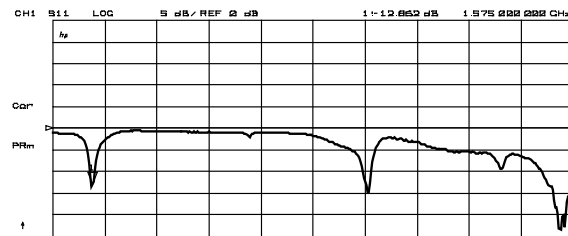
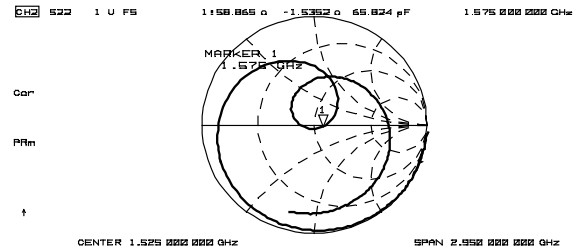
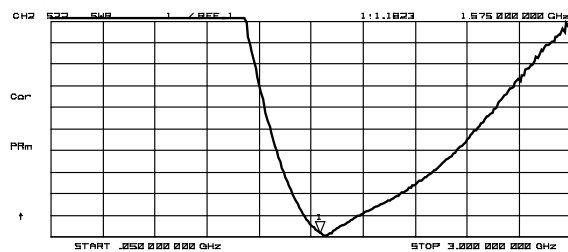
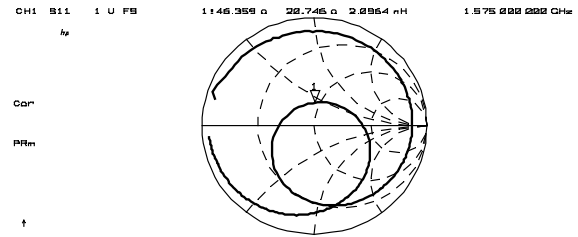
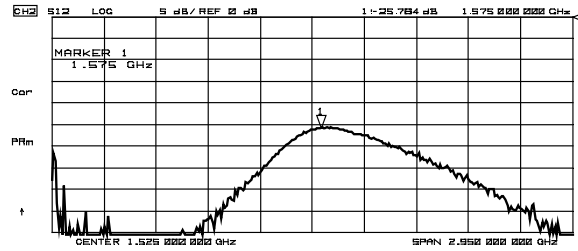
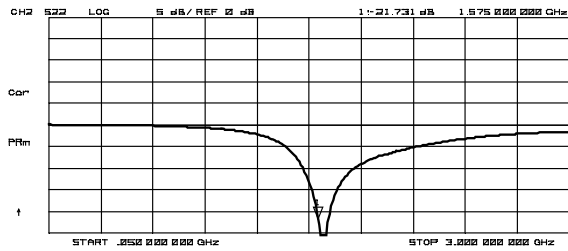
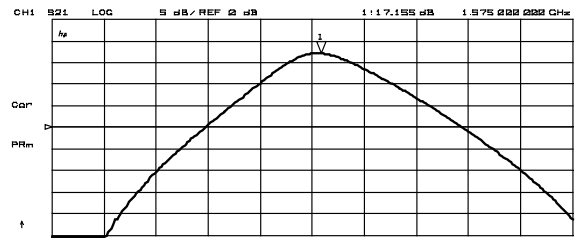
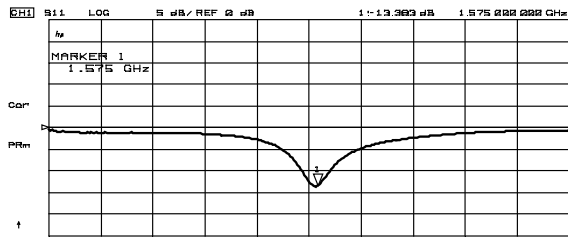

TEST CIRCUIT

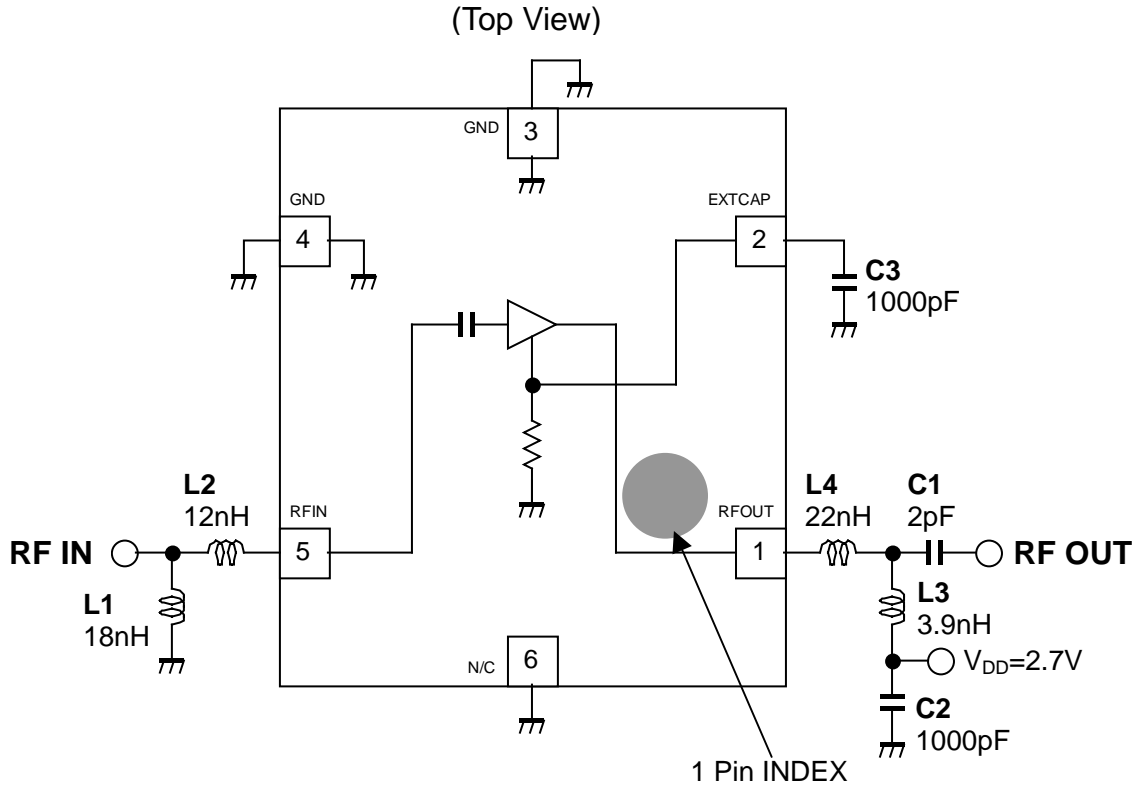

RECOMMENDED PCB DESIGN

(Top View)

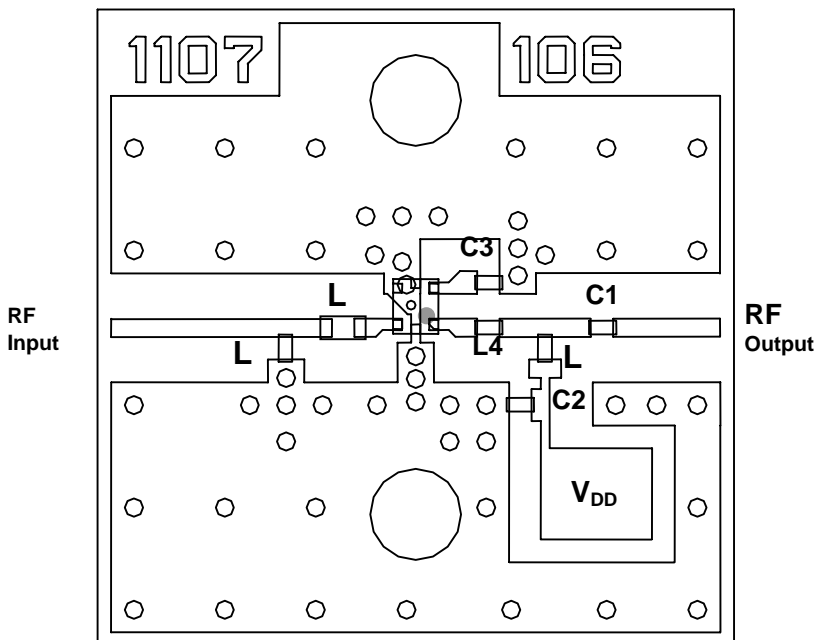

Parts ID	Comment
L1, L3, L4	TDK (MLK0603)
L2	TDK (MLG1005)
C1~C3	MURATA (GRM03)

PCB (FR-4):
 t=0.2mm
 MICROSTRIP LINE WIDTH
 =0.4mm ($Z_0=50\text{ohm}$)
 PCB SIZE=14.0mmX14.0mm

NJG1107HA8

PACKAGE OUTLINE (USB6-A8)

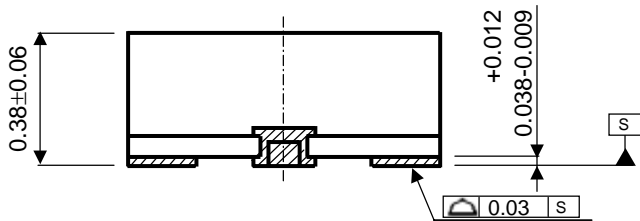
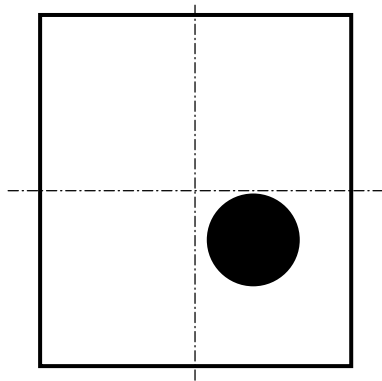

TERMINAL TREAT	:Au
Substrate	:FR5
Molding material	:Epoxy resin
UNIT	:mm
WEIGHT	:1.1mg

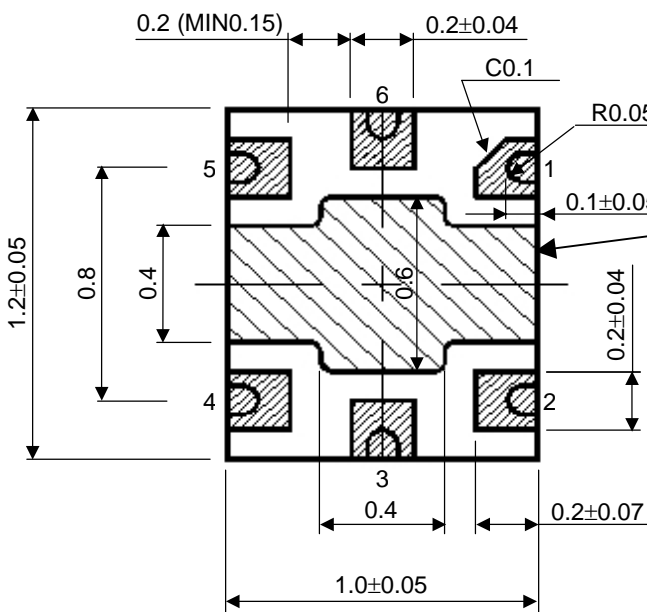
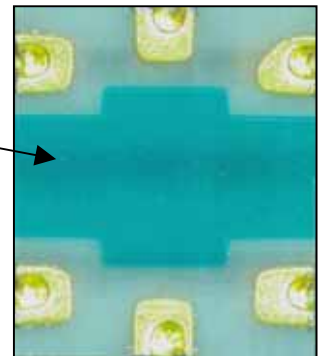

Photo resist coating



Cautions on using this product

- This product contains Gallium-Arsenide (GaAs) which is a harmful material.
- Do NOT eat or put into mouth.
 - Do NOT dispose in fire or break up this product.
 - Do NOT chemically make gas or powder with this product.
 - To waste this product, please obey the relating law of your country.

[CAUTION]

The specifications on this databook are only given for information, without any guarantee as regards either mistakes or omissions. The application circuits in this databook are described only to show representative usages of the product and not intended for the guarantee or permission of any right including the industrial rights.

This product may be damaged with electric static discharge (ESD) or spike voltage. Please handle with care to avoid these damages.