

GPS LOW NOISE AMPLIFIER GaAs MMIC

■GENERAL DESCRIPTION

This IC is a Low Noise Amplifier GaAs MMIC designed for GPS. This amplifier provides low noise figure, high gain and high IP3 operated by single low positive power supply.

This IC has the function of Stand-by mode.

This amplifier can be tuned to wide frequency point (1.5GHz~2.4GHz).

An ultra small and ultra thin package of USB6-A8 is adopted.

■PACKAGE OUTLINE

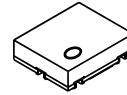

NJG1108HA8

■FEATURES

- Low voltage operation +2.7V typ.
- Low current consumption 2.0mA typ. @ $V_{CTL}=1.85V$
- 1uA typ. @ $V_{CTL}=0V$
- High small signal gain 19dB typ. @ $f_{V_{CTL}=1.85V}, f=1.575GHz$
- Low noise figure 1.0dB typ. @ $V_{CTL}=1.85V, f=1.575GHz$
- Pin at 1dB Gain Compression point -15.0dBm typ. @ $V_{CTL}=1.85V, f=1.575GHz$
- High Input IP3 0dBm typ. @ $V_{CTL}=1.85V, f=1.575+1.5751GHz$
- Ultra small & ultra thin package USB6-A8 (Package size: 1.0x1.2x0.38mm)

■PIN CONFIGURATION

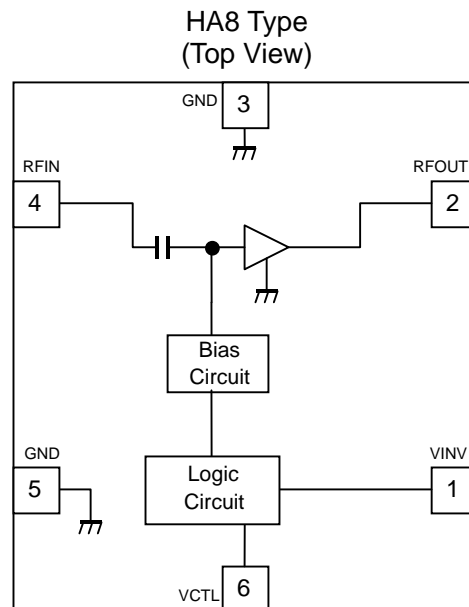

Pin Connection

1. VINV
2. RFOUT
3. GND
4. RFIN
5. GND
6. VCTL

■TRUTH TABLE

“H”= $V_{CTL(H)}$, “L”= $V_{CTL(L)}$

V_{CTL}	LNA Mode
H	Active Mode
L	Sleep Mode

Note: Specifications and description listed in this catalog are subject to change without notice.

NJG1108HA8

www.DataSheet4U.com

■ABSOLUTE MAXIMUM RATINGS

$T_a=+25^{\circ}\text{C}$, $Z_s=Z_i=50\text{ohm}$

PARAMETER	SYMBOL	CONDITIONS	RATINGS	UNITS
Drain Voltage	V_{DD}		5.0	V
Inverter voltage	V_{INV}		5.0	V
Control voltage	V_{CTL}		5.0	V
Input power	P_{in}	$V_{DD}=2.7\text{V}$	+15	dBm
Power dissipation	P_D	On PCB board, $T_{jmax}=150^{\circ}\text{C}$	150	mW
Operating temperature	T_{opr}		-40~+85	$^{\circ}\text{C}$
Storage temperature	T_{stg}		-55~+150	$^{\circ}\text{C}$

■ELECTRICAL CHARACTERISTICS 1

GENERAL CONDITIONS: $V_{DD}=V_{INV}=2.7\text{V}$, $T_a=+25^{\circ}\text{C}$, $Z_s=Z_i=50\text{ohm}$

PARAMETERS	SYMBOL	CONDITIONS	MIN	TYP	MAX	UNITS
Operating voltage	V_{DD}		2.5	2.7	3.5	V
Inverter supply voltage	V_{INV}		2.5	2.7	3.5	V
Control voltage (High)	$V_{CTL(H)}$		1.5	1.85	$V_{INV}+0.3$	V
Control voltage (Low)	$V_{CTL(L)}$		0	0	0.3	V
Operating current1 (Active Mode, RF OFF)	I_{DD1}	RF OFF, $V_{CTL}=1.85\text{V}$	-	2.0	3.0	mA
Operating current2 (Sleep Mode, RF OFF)	I_{DD2}	RF OFF, $V_{CTL}=0\text{V}$	-	1	5	μA
Inverter current1	I_{INV1}	RF OFF, $V_{CTL}=1.85\text{V}$	-	30	60	μA
Inverter current2	I_{INV2}	RF OFF, $V_{CTL}=0\text{V}$	-	9	20	μA
Control current	I_{CTL}	RF OFF, $V_{CTL}=1.85\text{V}$	-	6	20	μA

■ ELECTRICAL CHARACTERISTICS 2 (Active Mode, RF OFF)

GENERAL CONDITIONS: $V_{DD}=V_{INV}=2.7V$, $V_{CTL}=1.85V$, $f_{RF}=1575MHz$, $T_a=+25^{\circ}C$, $Z_s=Z_l=50ohm$

PARAMETERS	SYMBOL	CONDITIONS	MIN	TYP	MAX	UNITS
Operating Frequency	freq		1.57	1.575	1.58	GHz
Small signal gain	Gain		17.0	19.0	21.5	dB
Noise figure	NF	Exclude PCB & connector losses (IN: 0.09dB)	-	1.0	1.2	dB
Pin at 1dB gain compression point	$P_{-1dB(IN)}$		-19.0	-15.0	-	dBm
Input 3rd order intercept point	IIP3	$f1=f_{RF}$, $f2=f_{RF}+100kHz$, $Pin=-34dBm$	-5.0	0	-	dBm
RF IN VSWR	VSWR _i		-	2.0	2.5	
RF OUT VSWR	VSWR _o		-	1.5	2.0	

NJG1108HA8

www.DataSheet4U.com

■ TERMINAL INFORMATION

No.	SYMBOL	DESCRIPTION
1	VINV	Power supply pin of the inverter circuit.
2	RFOUT	RF Output and voltage supply pin. External matching circuits and a bypass capacitor is required. L3 is a RF choke inductor. These elements are used as output matching circuit.
3	GND	Ground pin. To keep good RF grounding performance, please use multiple via holes to connect with ground plane and this pin.)
4	RFIN	RF input pin. A DC blocking capacitor is not required. An external matching circuit is required.
5	GND	Ground pin. To keep good RF grounding performance, please use multiple via holes to connect with ground plane and this pin.)
6	VCTL	Control voltage input pin. This control pin is set to high. LNA suffers from standby state when LNA puts the changeover voltage of "Low" in a state of movement when the changeover voltage of "High" is put in this terminal.

CAUTION

1) Ground terminal (3, 5) should be connected to the ground plane as low inductance as possible.

■ **ELECTRICAL CHARACTERISTICS** (Condition: $T_a=+25^{\circ}\text{C}$, $V_{DD}=V_{INV}=2.7\text{V}$, $V_{CTL}=1.85\text{V}$, $Z_S=Z_L=50\text{ohm}$)

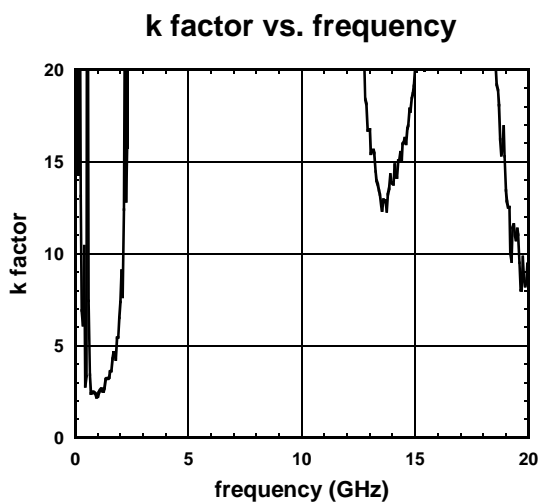
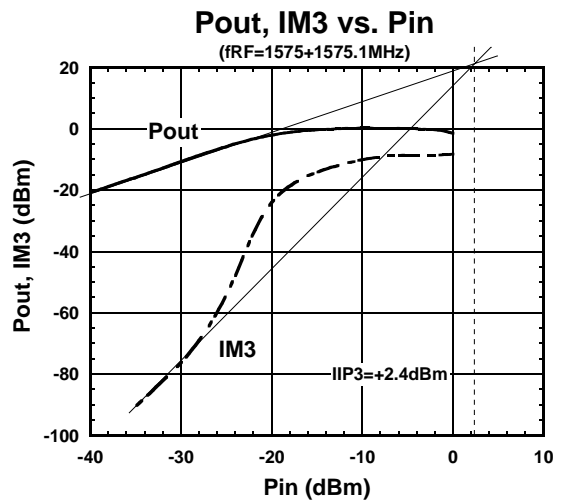
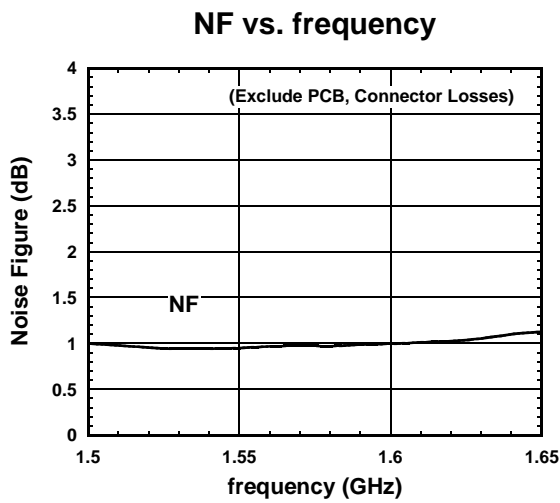
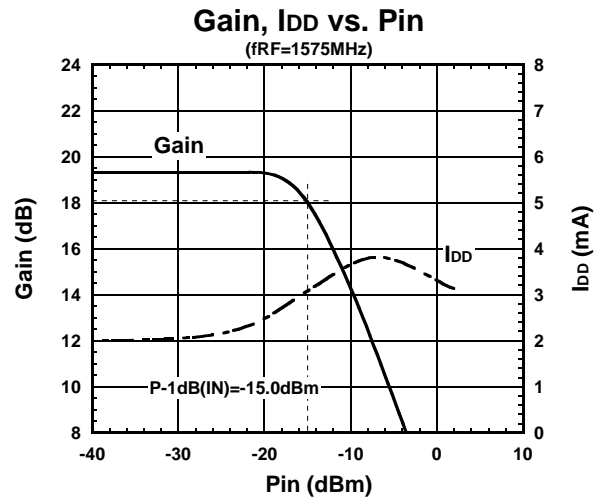
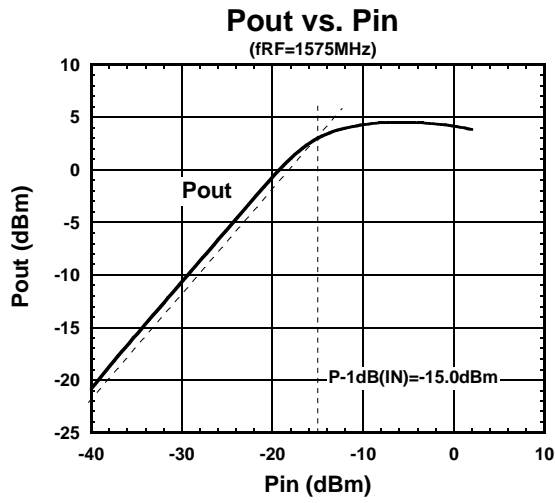

NJG1108HA8

www.DataSheet4U.com

■ ELECTRICAL CHARACTERISTICS (Condition: $T_a=+25^{\circ}\text{C}$, $V_{DD}=V_{INV}=2.7\text{V}$, $V_{CTL}=1.85\text{V}$, $Z_S=Z_L=50\text{ohm}$)

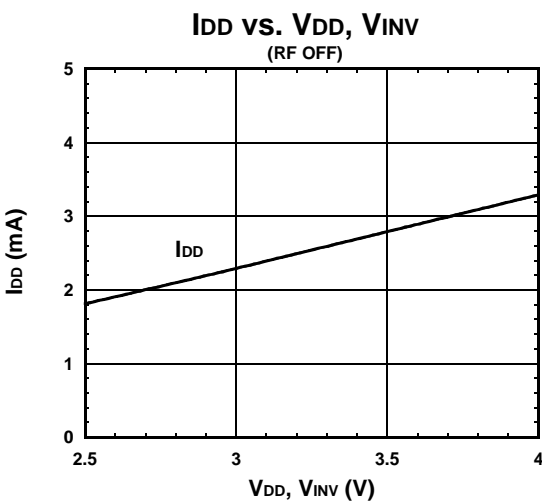
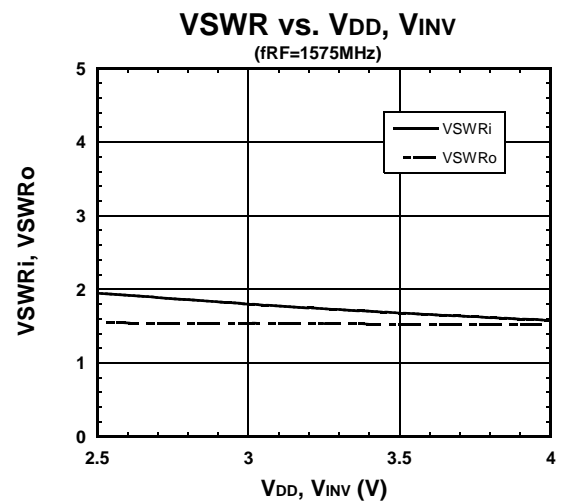
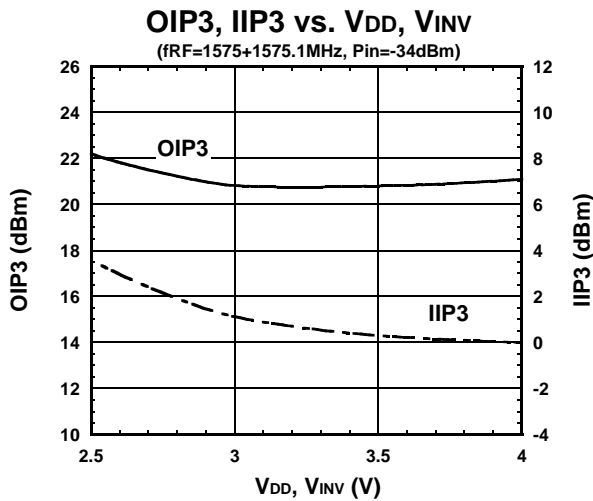
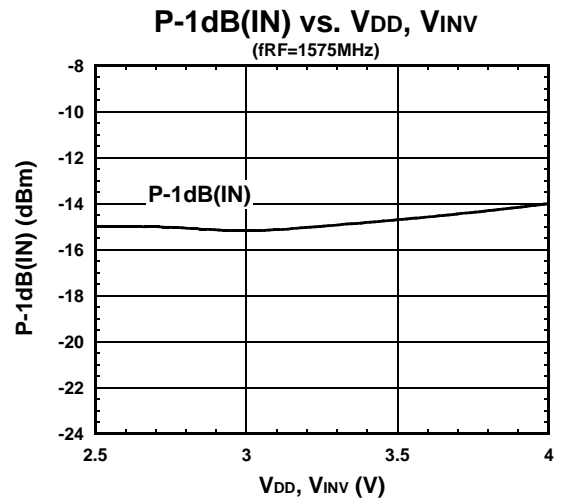
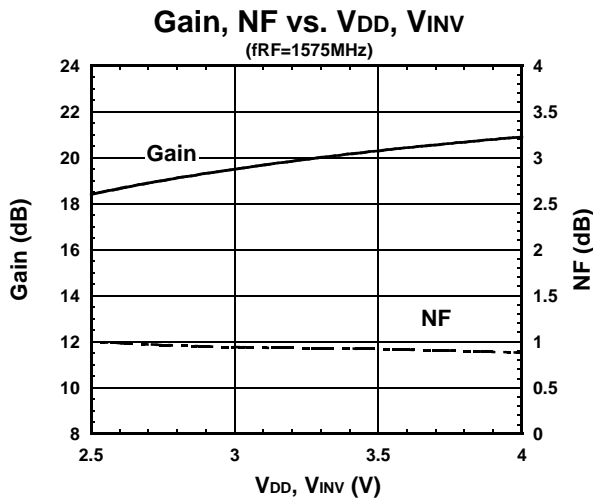

■ **ELECTRICAL CHARACTERISTICS** (Condition: $T_a=+25^\circ\text{C}$, $V_{DD}=V_{INV}=2.7\text{V}$, $V_{CTL}=1.85\text{V}$, $Z_S=Z_L=50\text{ohm}$)

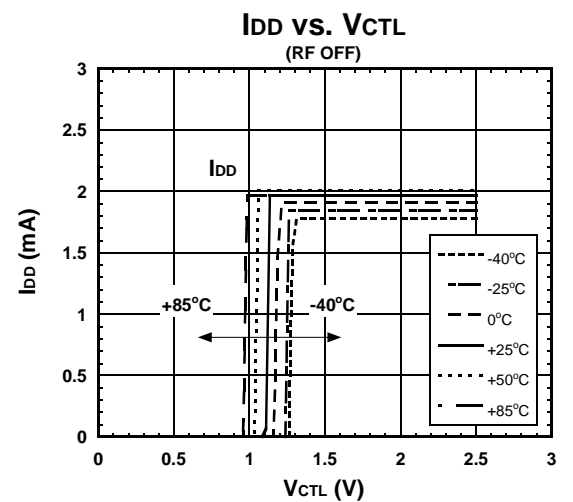
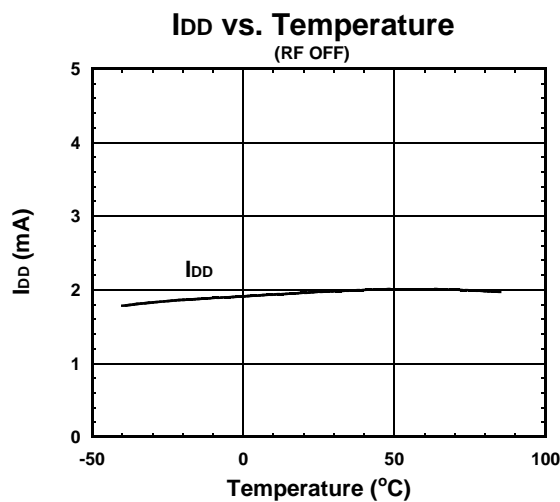
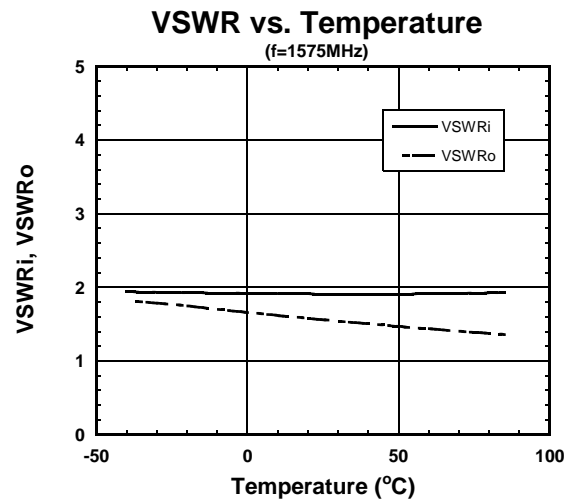
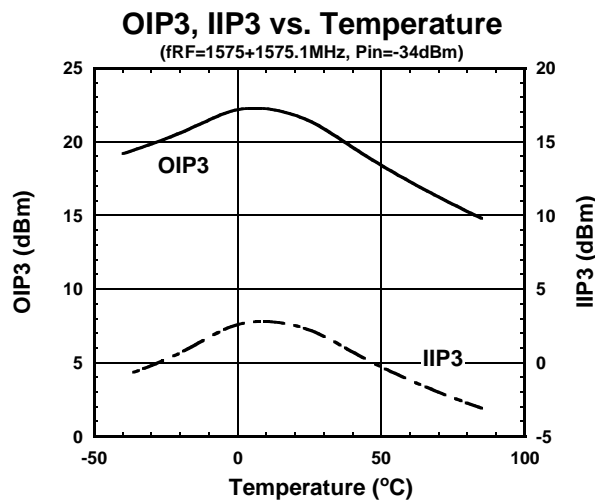
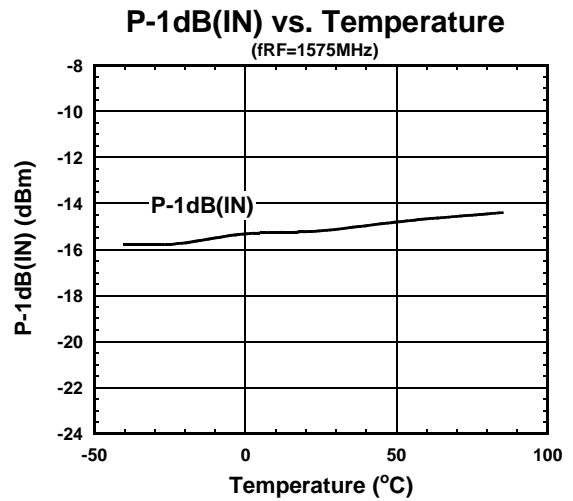
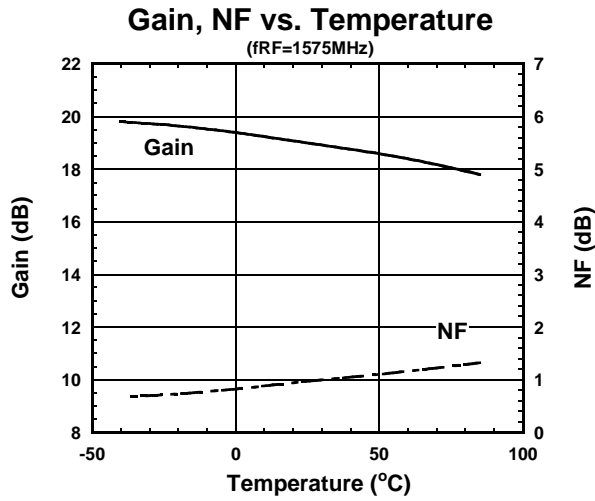

NJG1108HA8

www.DataSheet4U.com

■ ELECTRICAL CHARACTERISTICS (Condition: $T_a=+25^{\circ}\text{C}$, $V_{DD}=V_{INV}=2.7\text{V}$, $V_{CTL}=1.85\text{V}$, $Z_S=Z_L=50\text{ohm}$)

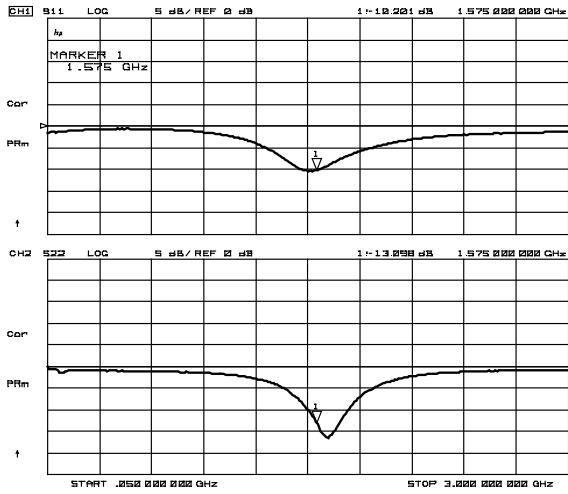

S11, S22

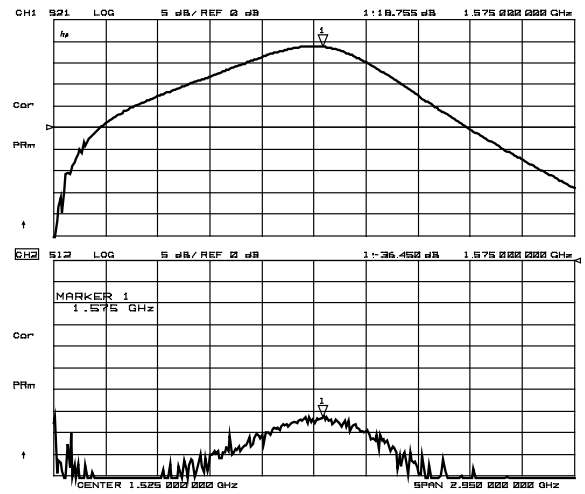

S21, S12

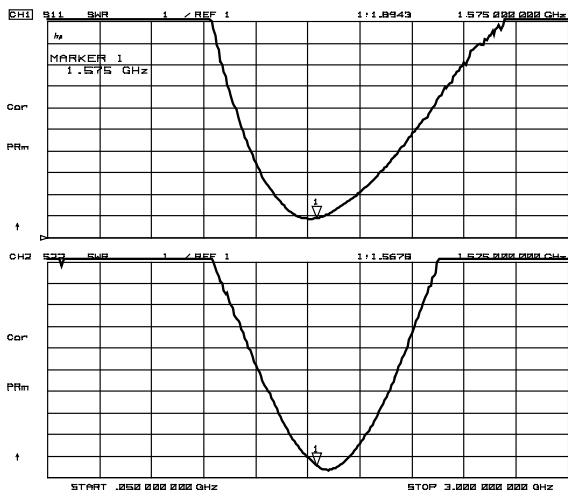

VSWR

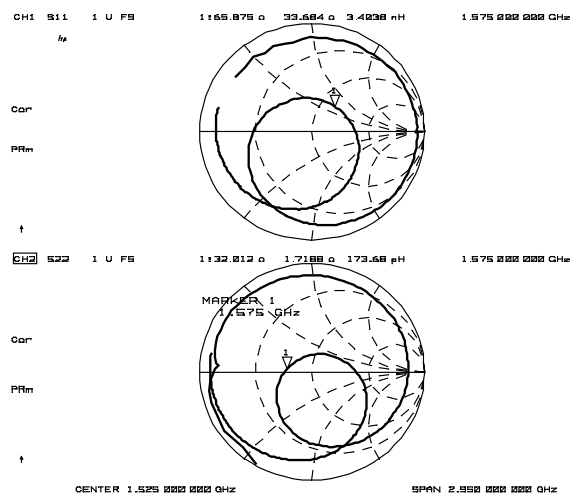

Zin, Zout

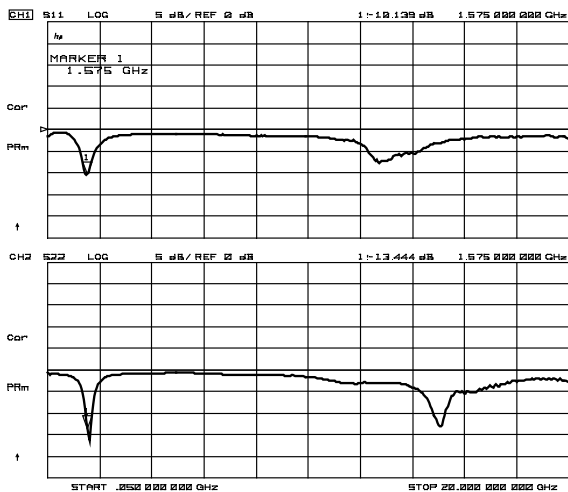

S11, S22 (f=50MHz~20GHz)

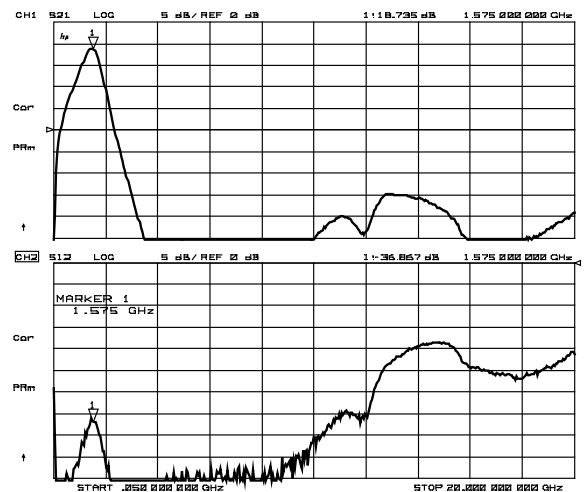

S21, S12 (f=50MHz~20GHz)

TEST CIRCUIT

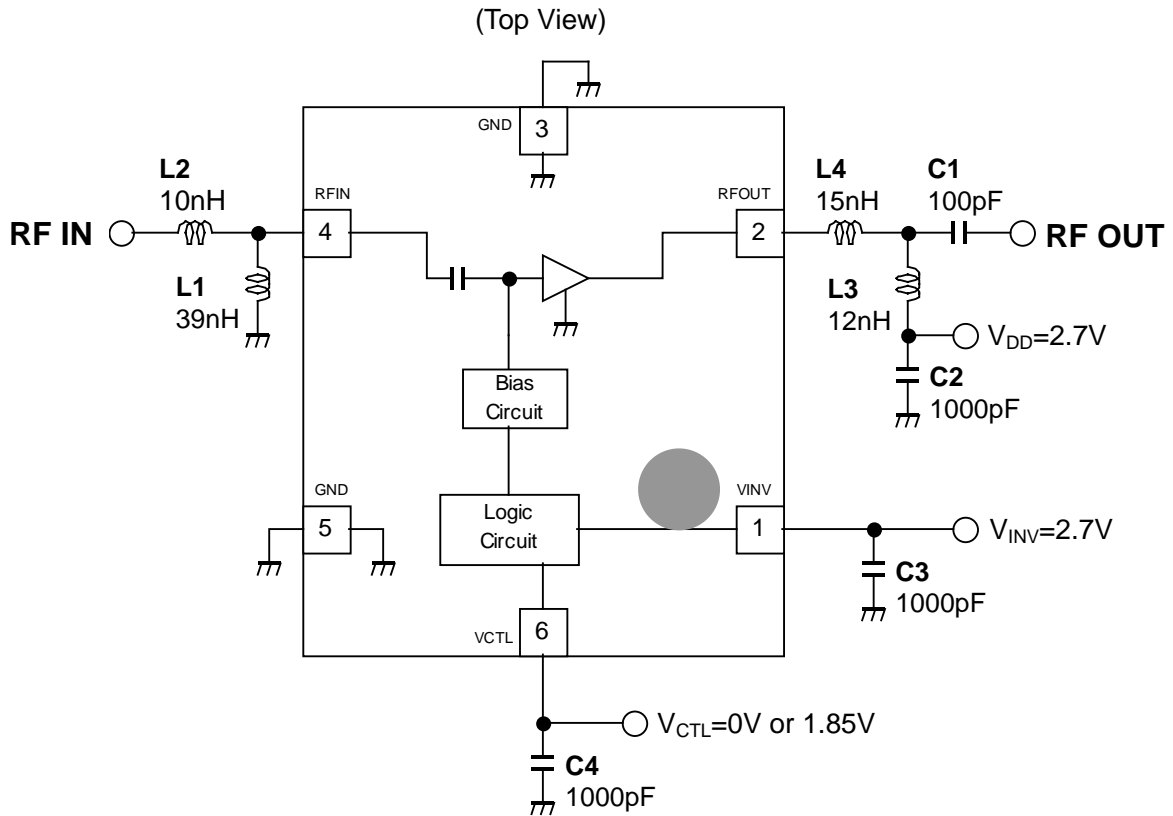

RECOMMENDED DESIGN

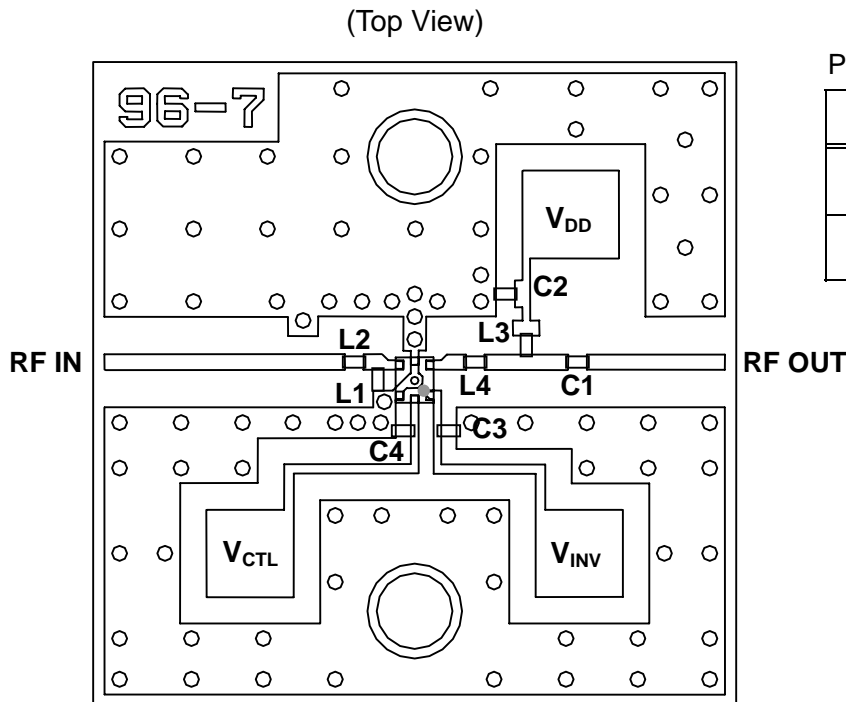

Parts List

Parts ID	Notes
L1~L4	MURATA (LQP03T series)
C1~C3	MURATA (GRM03 series)

PCB (FR-4): t=0.2mm
 MICROSTRIP LINE WIDTH
 =0.4mm (Z₀=50ohm)
 PCB SIZE=17.0mmx17.0mm

