

PDC Dual Band LNA GaAs MMIC

■GENERAL DESCRIPTION

The NJG1112PB1 is a dual band low noise amplifier for 800MHz and 1500MHz band. The band switching between 800MHz CD, A Band and 1500MHz is made by 2 bit control signal by using inverter circuit included in this IC.

The ultra small and thin FFP12-B1 is applied.

■PACKAGE OUTLINE

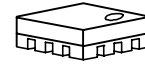

NJG1112PB1

■FEATURES

- Low voltage operation +2.8V typ.
- Low current consumption +2.6mA typ. @800MHz CD, A Band
+2.8mA typ. @1.5GHz Band
- Low control current 20uA typ.
- High gain 18.5dB typ. @f=830MHz
18dB typ. @f=878MHz
17.5dB typ. @f=1490MHz
- Low noise figure 1.6dB typ. @f=830MHz
1.5dB typ. @f=878MHz
1.15dB typ. @f=1490MHz
- High input IP3 -7dBm typ. @f=830.0+830.1MHz
-7dBm typ. @f=878.0+878.1MHz
-5dBm typ. @f=1490.0+1490.1MHz
- Ultra small & thin package FFP12-B1 (Package size: 2.0x2.0x0.85mm)

■PIN CONFIGURATION

(Top View)

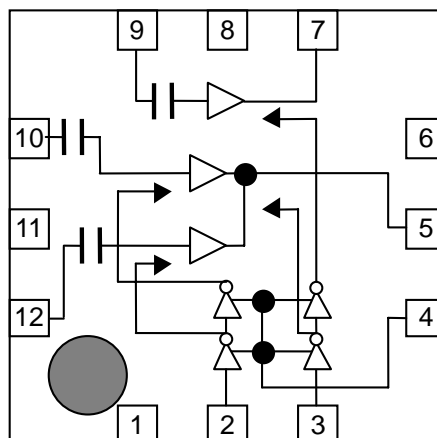

Pin Connection

- 1.GND
- 2.VCTL1
- 3.VCTL2
- 4.VINV
- 5.RFOUT1(800MHz Band)
- 6.GND
- 7.RFOUT2(1.5GHz Band)
- 8.GND
- 9.RFIN3(1.5GHz Band)
- 10.RFIN2(800MHz A Band)
- 11.GND
- 12.RFIN1(800MHz CD Band)

Note: The specifications and description listed in this catalog are subject to change without prior notice.

NJG1112PB1

www.DataSheet4U.com

■ABSOLUTE MAXIMUM RATINGS

($T_a=25^{\circ}\text{C}$, $Z_s=Z_l=50\Omega$)

PARAMETERS	SYMBOL	CONDITIONS	RATINGS	UNITS
Operating voltage	V_{DD}		5.0	V
Inverter supply voltage	V_{INV}		5.0	V
Control voltage	V_{CTL}		V_{INV}	V
Input power	P_{in}	$V_{DD}=2.8\text{V}$	+15	dBm
Power dissipation	P_D		300	mW
Operating temperature	T_{opr}		-40~+85	$^{\circ}\text{C}$
Storage temperature	T_{stg}		-55~+125	$^{\circ}\text{C}$

■ELECTRICAL CHARACTERISTICS 1 (DC)

GENERAL CONDITIONS: $T_a=+25^{\circ}\text{C}$, $Z_s=Z_l=50\Omega$, $V_{DD}=V_{INV}=2.8\text{V}$

PARAMETERS	SYMBOL	CONDITIONS	MIN	TYP	MAX	UNITS
Operating voltage	V_{DD}		2.5	2.8	4.5	V
Inverter supply voltage	V_{INV}		2.5	2.8	4.5	V
Control voltage1 (High)	$V_{CTL1(H)}$		2.0	2.4	V_{INV}	V
Control voltage1 (Low)	$V_{CTL1(L)}$		0.0	0.0	0.8	V
Control voltage2 (High)	$V_{CTL2(H)}$		2.0	2.4	V_{INV}	V
Control voltage2 (Low)	$V_{CTL2(L)}$		0.0	0.0	0.8	V
Operating current	I_{DD1}	RF OFF, $V_{CTL1}=0\text{V}$, $V_{CTL2}=0\text{V}$	-	2.6	3.25	mA
	I_{DD2}	RF OFF, $V_{CTL1}=2.4\text{V}$, $V_{CTL2}=0\text{V}$	-	2.6	3.25	mA
	I_{DD3}	RF OFF, $V_{CTL1}=0\text{V}$, $V_{CTL2}=2.4\text{V}$	-	2.8	3.5	mA
Inverter current	I_{INV}	RF OFF	-	190	250	μA
Control current	I_{CTL1}	$V_{CTL1}=2.4\text{V}$, $V_{CTL2}=0\text{V}$	-	20	60	μA
	I_{CTL2}	$V_{CTL2}=2.4\text{V}$, $V_{CTL1}=0\text{V}$	-	20	60	μA

■TRUTH TABLE

Control Voltage: "H"= $V_{CTL1(H)}$, $V_{CTL2(H)}$, "L"= $V_{CTL1(L)}$, $V_{CTL2(L)}$

VCTL1	L	H	L
VCTL2	L	L	H
800MHz CD Band	ON	OFF	OFF
800MHz A Band	OFF	ON	OFF
1.5GHz Band	OFF	OFF	ON

■ELECTRICAL CHARACTERISTICS 2 (800MHz CD BAND RF)

GENERAL CONDITIONS: $T_a=+25^{\circ}\text{C}$, $Z_s=Z_i=50\Omega$, $V_{DD}=V_{INV}=2.8\text{V}$, $V_{CTL1}=V_{CTL2}=0\text{V}$,
freq=830MHz, with application circuit

PARAMETERS	SYMBOL	CONDITIONS	MIN	TYP	MAX	UNITS
Operating frequency	freq		810	830	843	MHz
Small signal gain	Gain		17.5	18.5	19.5	dB
Gain flatness	G_{flat}	freq=810~843MHz	-	0.5	1.0	dB
Noise figure	NF	SSB NF	-	1.6	1.8	dB
Pout at 1dB gain compression point	$P_{-1dB(IN)}$		-21	-18	-	dBm
Input 3rd order intercept point	IIP3	f1=freq, f2=freq+100kHz, Pin=-36dBm	-10	-7	-	dBm
Isolation	ISO	-S12, freq=680~713MHz	25	30	-	dB
RF Input VSWR	$VSWR_i$		-	1.5	2.0	-
RF Output VSWR	$VSWR_o$		-	1.5	2.0	-

■ELECTRICAL CHARACTERISTICS 3 (800MHz A BAND RF)

GENERAL CONDITIONS: $T_a=+25^{\circ}\text{C}$, $Z_s=Z_i=50\Omega$, $V_{DD}=V_{INV}=2.8\text{V}$, $V_{CTL1}=2.4\text{V}$, $V_{CTL2}=0\text{V}$,
freq=878MHz, with application circuit

PARAMETERS	SYMBOL	CONDITIONS	MIN	TYP	MAX	UNITS
Operating frequency	freq		870	878	885	MHz
Small signal gain	Gain		17.0	18.0	19.0	dB
Gain flatness	G_{flat}	freq=870~885MHz	-	0.5	1.0	dB
Noise figure	NF	SSB NF	-	1.5	1.7	dB
Pout at 1dB gain compression point	$P_{-1dB(IN)}$		-21	-18	-	dBm
Input 3rd order intercept point	IIP3	f1=freq, f2=freq+100kHz, Pin=-36dBm	-10	-7	-	dBm
Isolation	ISO	-S12, freq=740~755MHz	25	30	-	dB
RF Input VSWR	$VSWR_i$		-	2.0	2.5	-
RF Output VSWR	$VSWR_o$		-	1.5	2.0	-

NJG1112PB1

www.DataSheet4

■ ELECTRICAL CHARACTERISTICS 4 (1500MHz BAND RF)

GENERAL CONDITIONS: $T_a=+25^{\circ}\text{C}$, $Z_s=Z_l=50\Omega$, $V_{DD}=V_{INV}=2.8\text{V}$, $V_{CTL1}=0\text{V}$, $V_{CTL2}=2.4\text{V}$,
freq=1490MHz, with application circuit

PARAMETERS	SYMBOL	CONDITIONS	MIN	TYP	MAX	UNITS
Operating frequency	freq		1477	1490	1501	MHz
Small signal gain	Gain		16.5	17.5	18.5	dB
Gain flatness	G_{flat}	freq=1477~1501MHz	-	0.5	1.0	dB
Noise figure	NF	SSB NF	-	1.15	1.35	dB
Pout at 1dB gain compression point	$P_{-1\text{dB(IN)}}$		-19	-16	-	dBm
Input 3rd order intercept point	IIP3	f1=freq, f2=freq+100kHz, Pin=-36dBm	-8	-5	-	dBm
Isolation	ISO	-S12, freq=1347~1371MHz	20	25	-	dB
RF Input VSWR	$VSWR_i$		-	1.5	2.0	-
RF Output VSWR	$VSWR_o$		-	1.5	2.0	-

■ TERMINAL INFORMATION

Pin	Symbol	Description
1	GND	Ground terminal (0V).
2	VCTL1	Control voltage input terminal. This terminal is set to 800MHz CD band or 800MHz A band to select.
3	VCTL2	Control voltage input terminal. This terminal is set to 800MHz band or 1.5GHz band to select.
4	VINV	Power supply terminal of the inverter circuit.
5	RFOUT1	Output terminal of 800MHz band. This terminal is also the power supply terminal of the LNA, please use inductor (L7) to connect power supply. (Please see application circuit.)
6	GND	Ground terminal (0V).
7	RFOUT2	Output terminal of 1.5GHz band. This terminal is also the power supply terminal of the LNA, please use inductor (L6) to connect power supply. (Please see application circuit.)
8	GND	Ground terminal (0V).
9	RFIN3	Output terminal of 1.5GHz band. The DC blocking capacitor is not required.
10	RFIN2	Output terminal of 800MHz A band. The DC blocking capacitor is not required.
11	GND	Ground terminal (0V).
12	RFIN1	Output terminal of 800MHz CD band. The DC blocking capacitor is not required.

NOTE:

- 1) Ground terminal (1, 6, 8, 11pin) should be connected to ground plane by multiple via holes for good grounding.
- 2) Please connect bypass capacitors possible close to inductors (L6, L7).

NJG1112PB1

www.DataSheet4U.com

TYPICAL CHARACTERISTICS (800MHz CD Band)

NF, Gain vs. freq

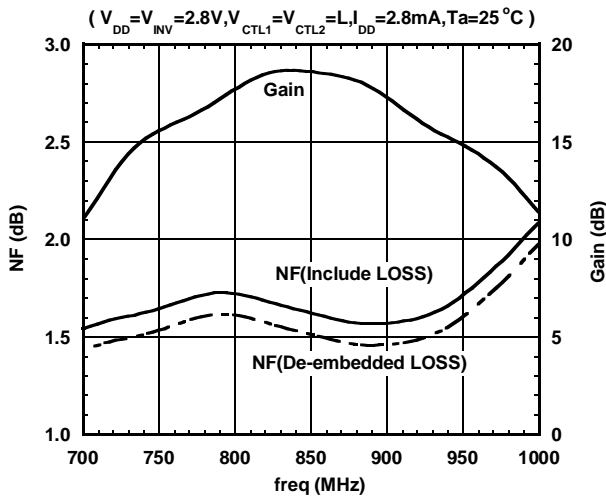

Pout vs. Pin, Gain

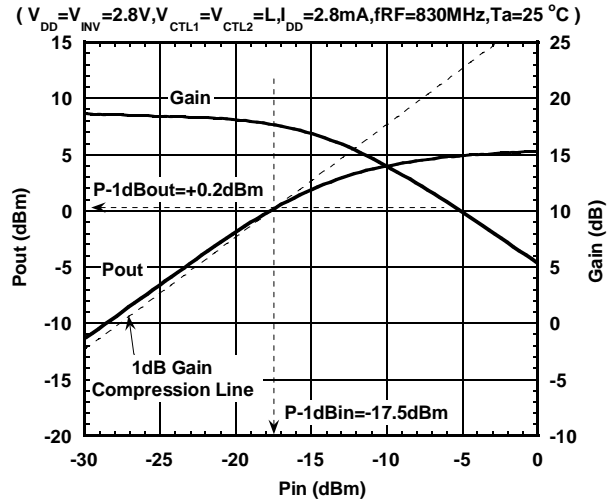

Pout, IM3 vs. Pin

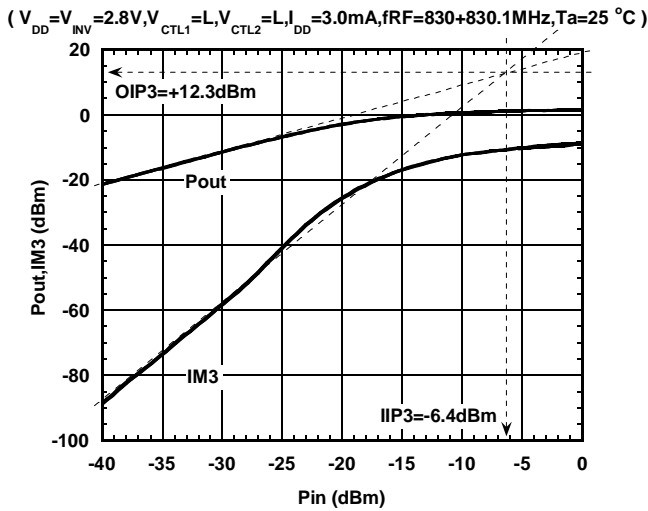

IIP3, OIP3 vs. freq

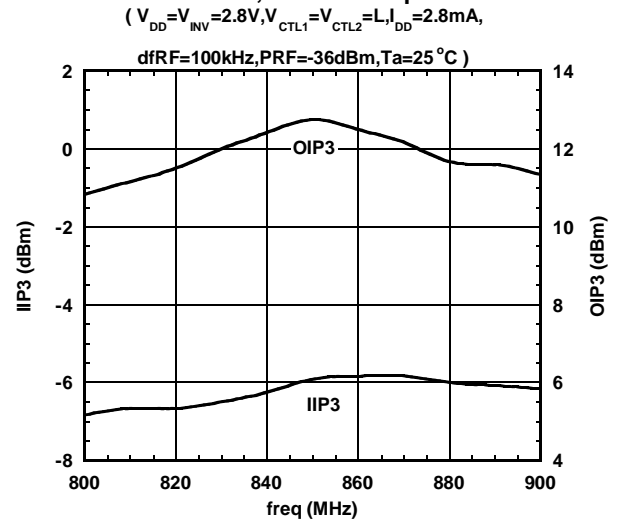

IDD vs. V_{DD}

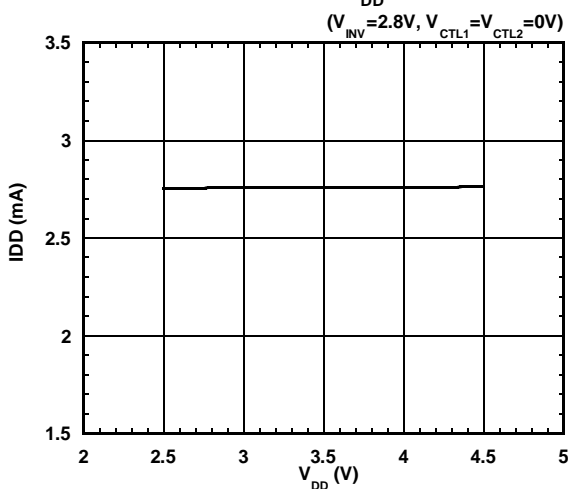

Gain, NF vs. V_{DD}

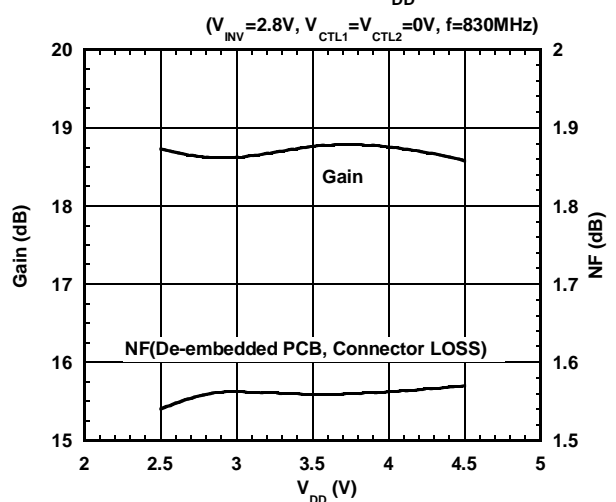

TYPICAL CHARACTERISTICS (800MHz CD Band)

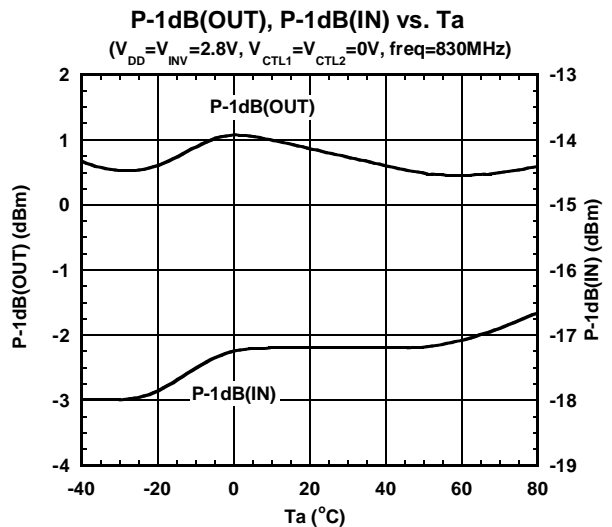
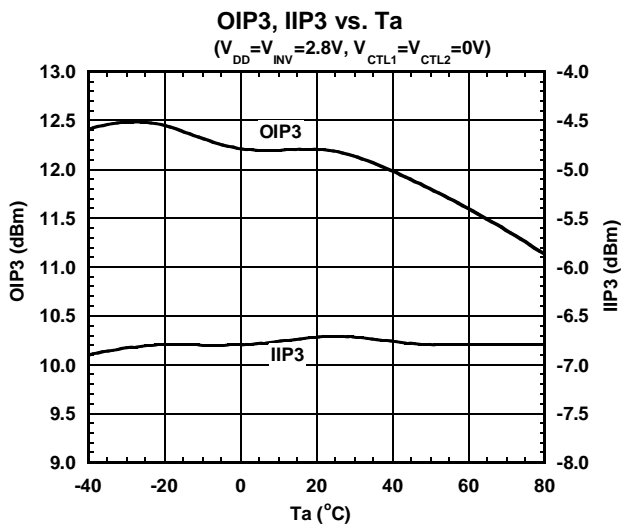
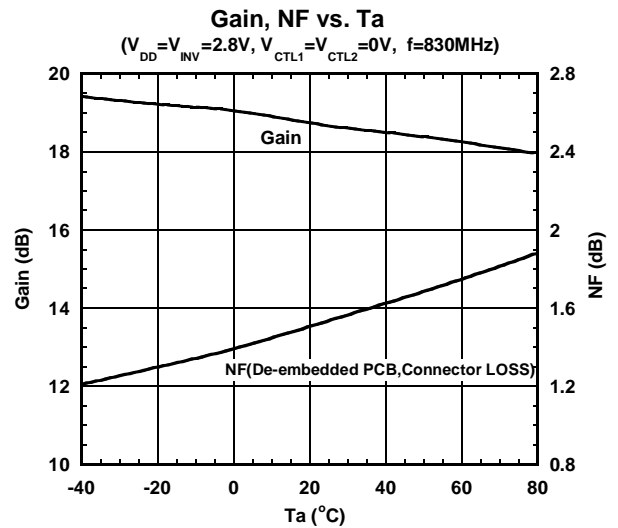
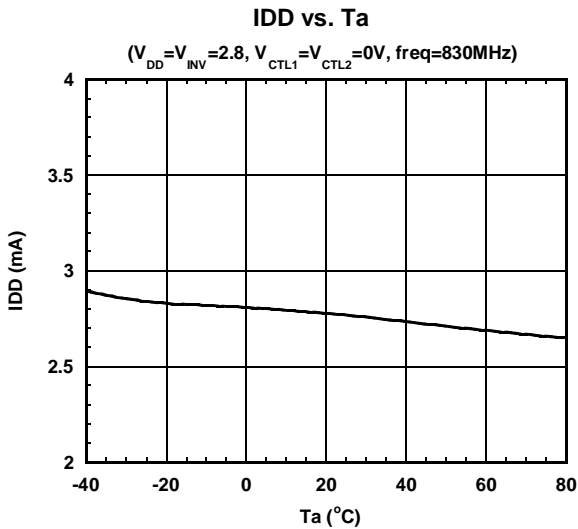
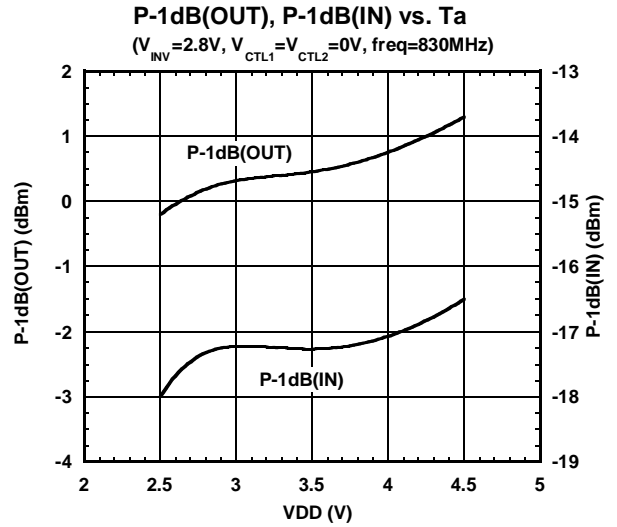
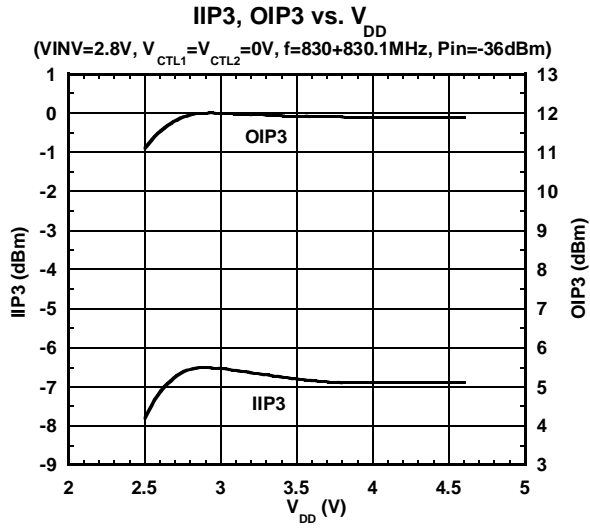

NJG112PB1

www.DataSheet4U.com

TYPICAL CHARACTERISTICS (800MHz CD Band)

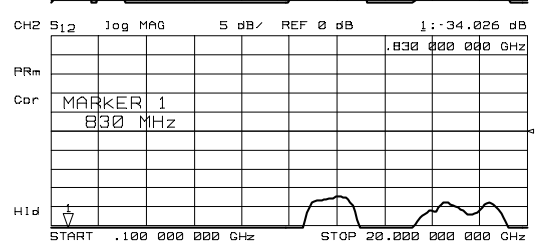
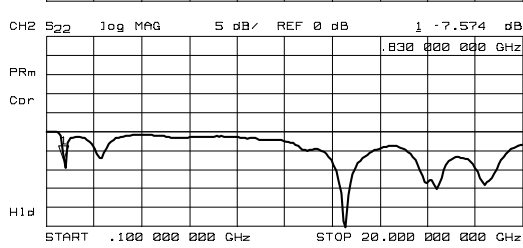
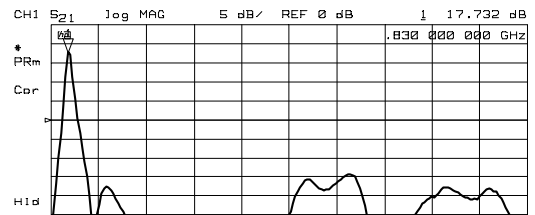
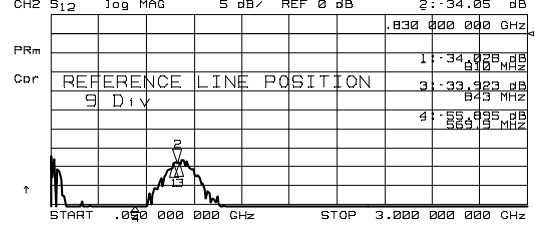
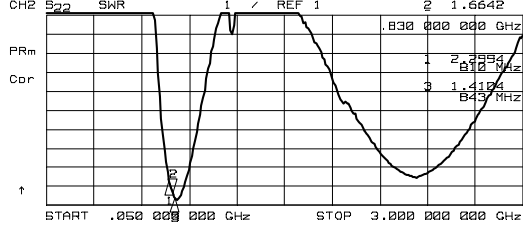
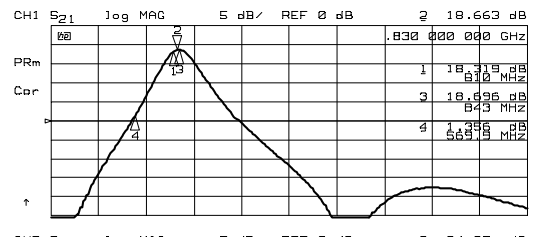
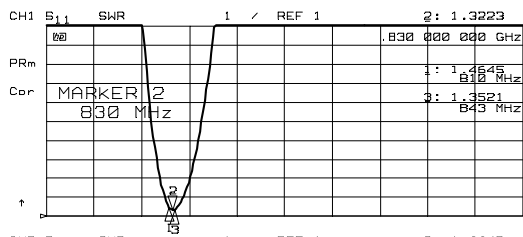
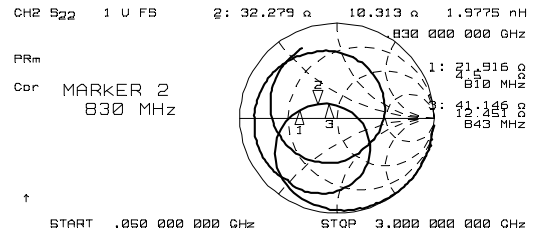
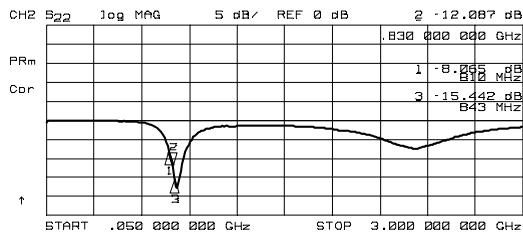
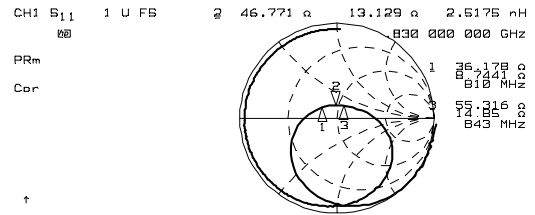
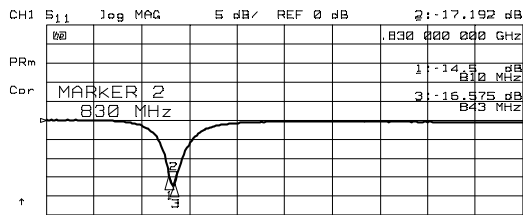

TYPICAL CHARACTERISTICS (800MHz A Band)

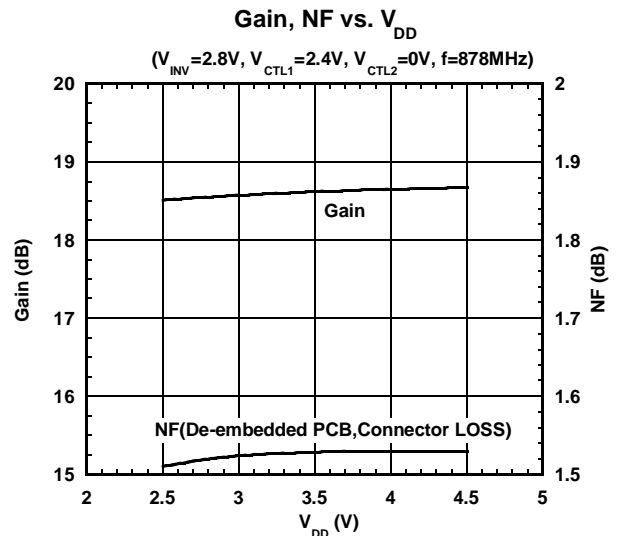
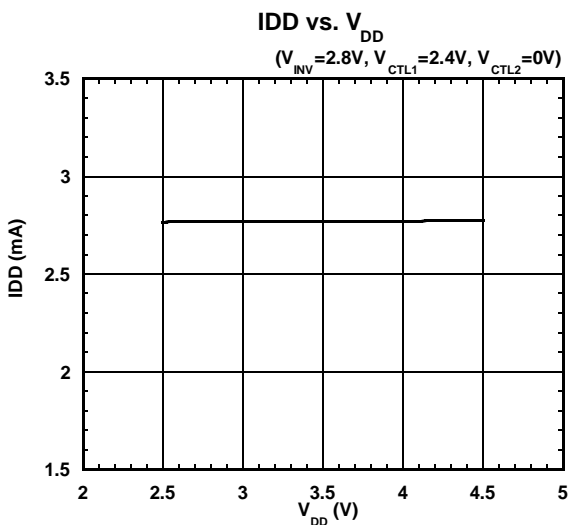
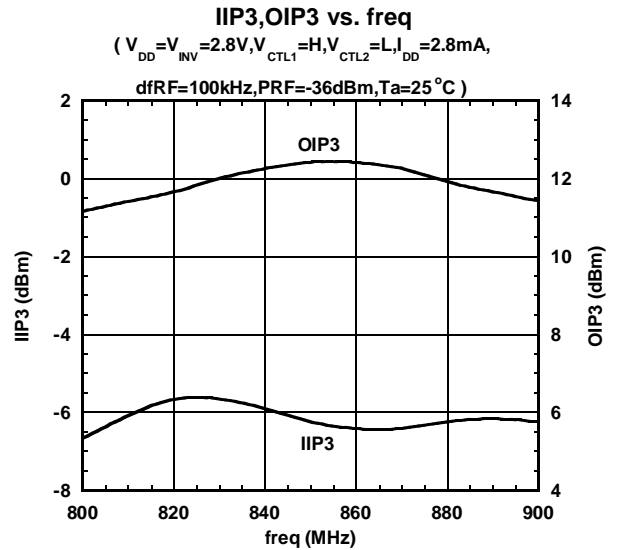
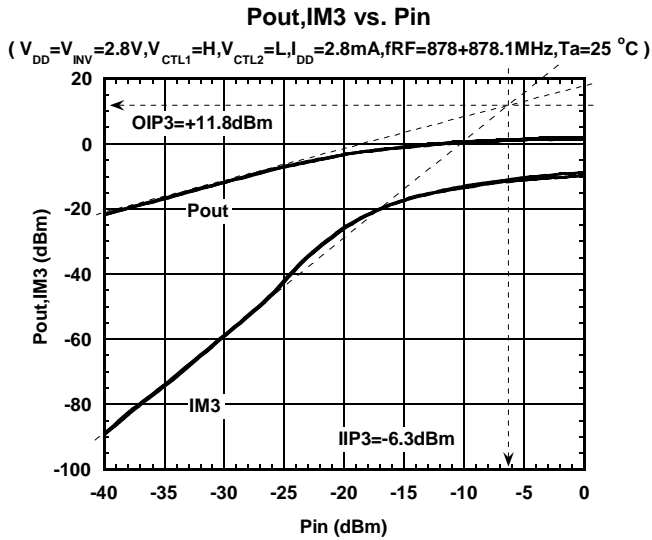
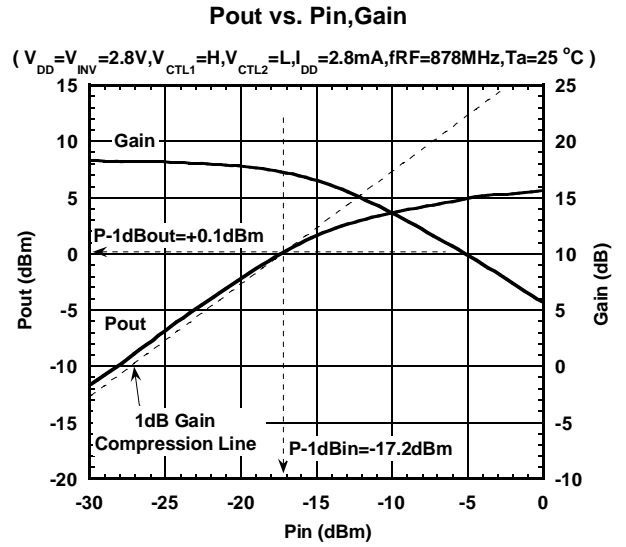
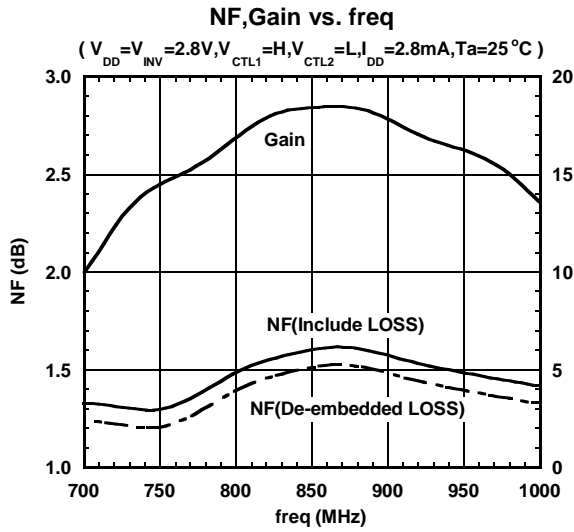

NJG1112PB1

www.DataSheet4U.com

TYPICAL CHARACTERISTICS (800MHz A Band)

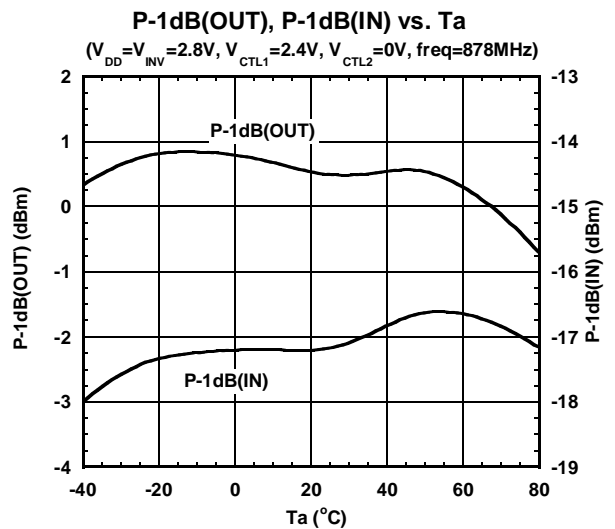
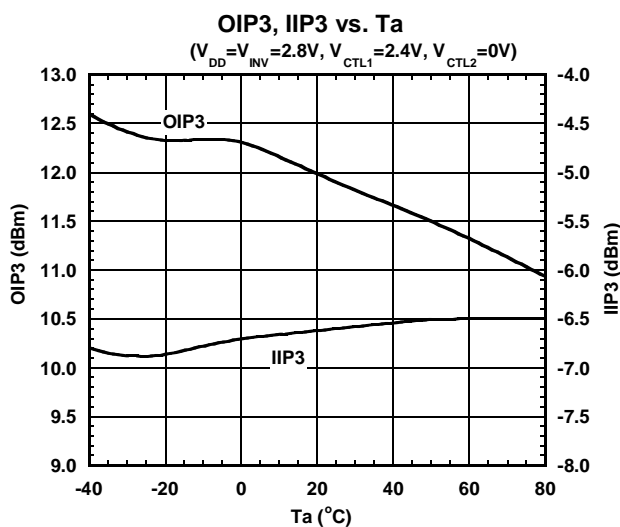
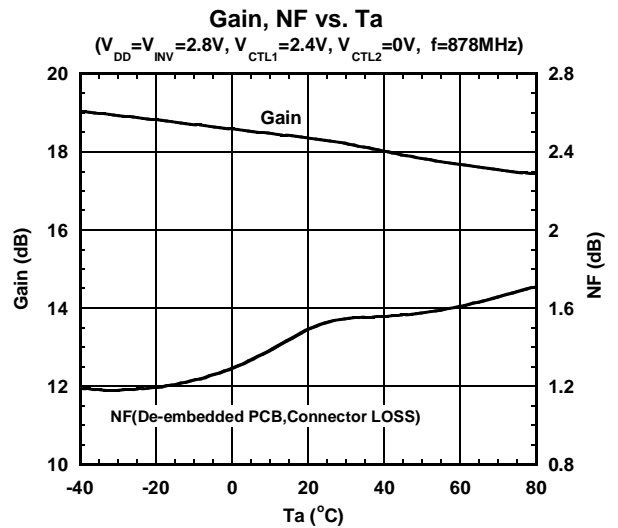
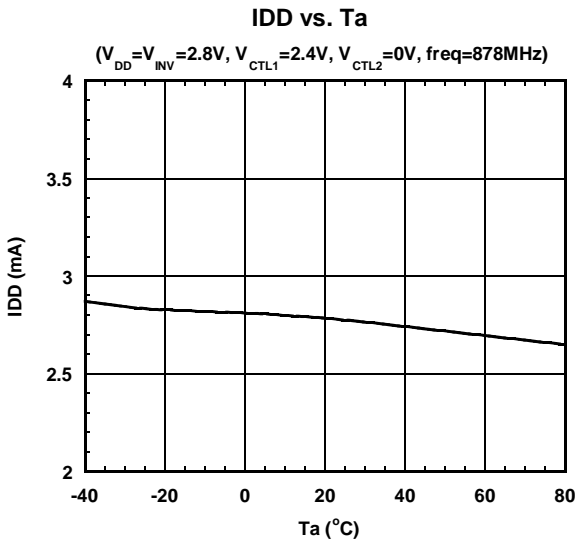
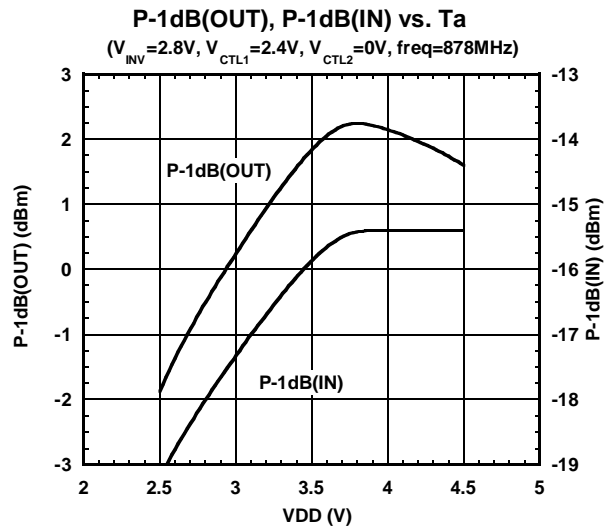
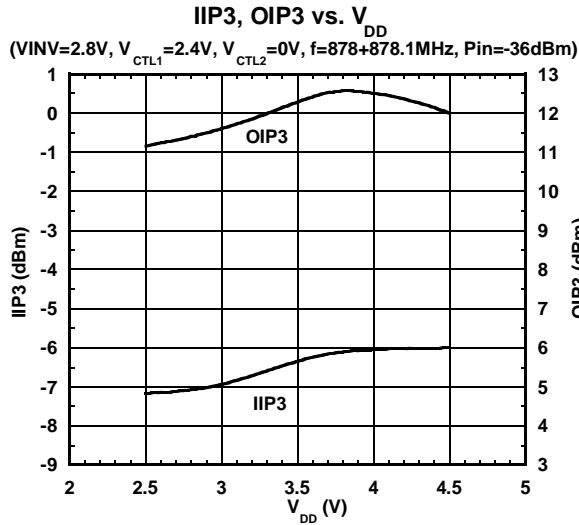

TYPICAL CHARACTERISTICS (800MHz A Band)

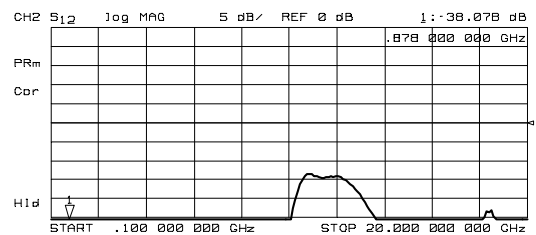
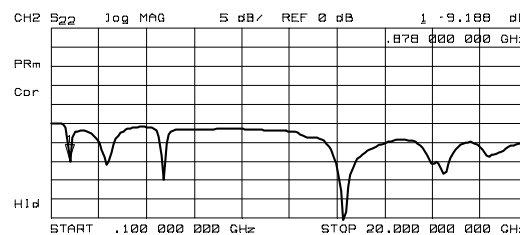
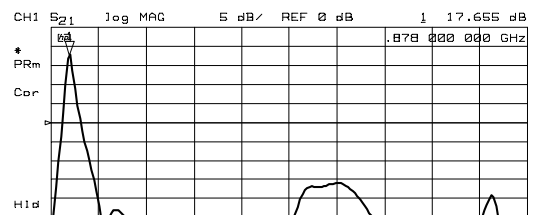
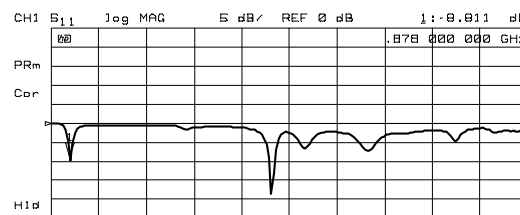
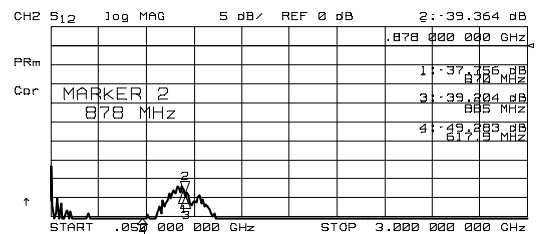
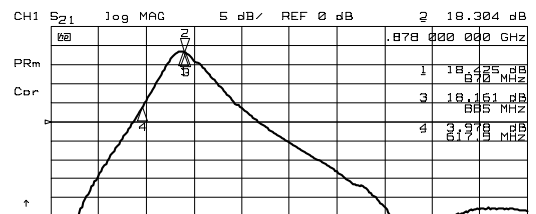
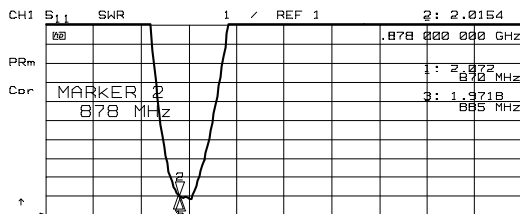
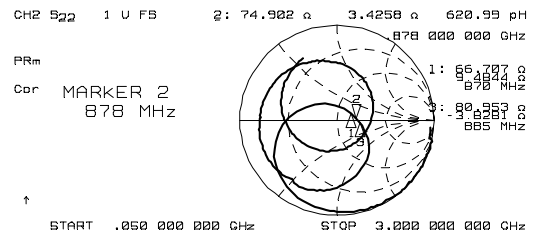
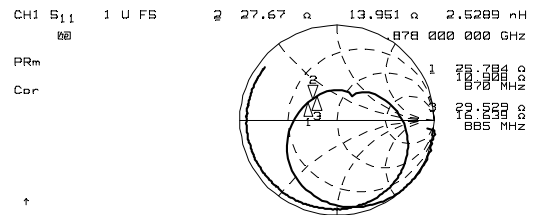
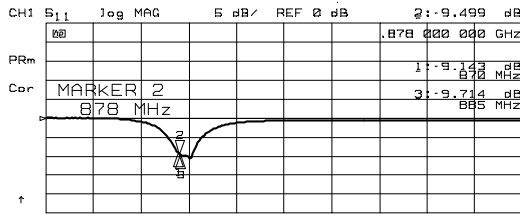

NJG1112PB1

www.DataSheet4U.com

TYPICAL CHARACTERISTICS (1.5GHz Band)

NF, Gain vs. freq

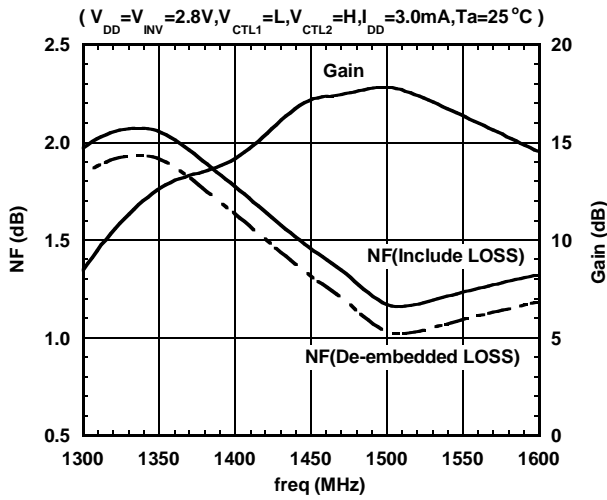

Pout vs. Pin, Gain

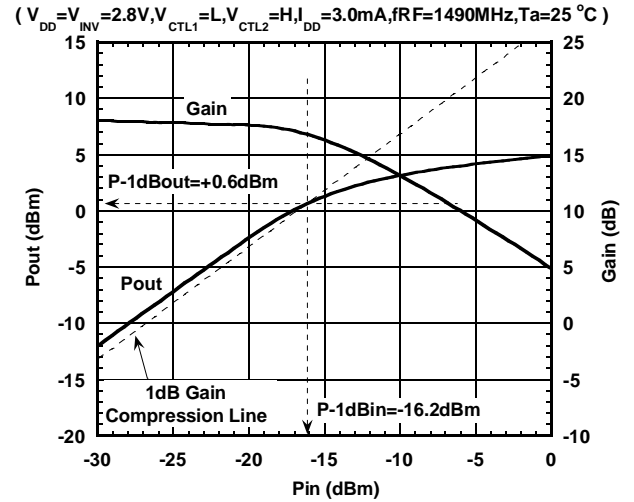

Pout, IM3 vs. Pin

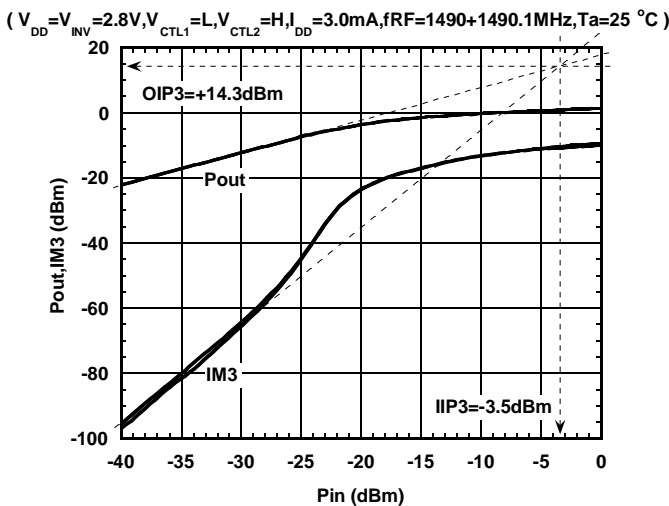

IIP3, OIP3 vs. freq

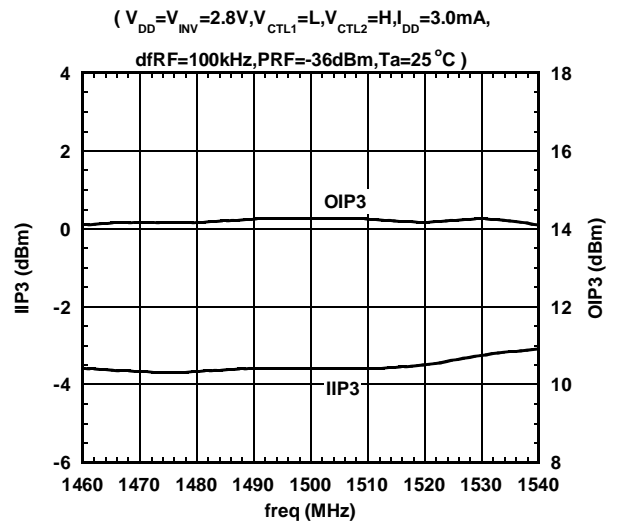

IDD vs. V_{DD}

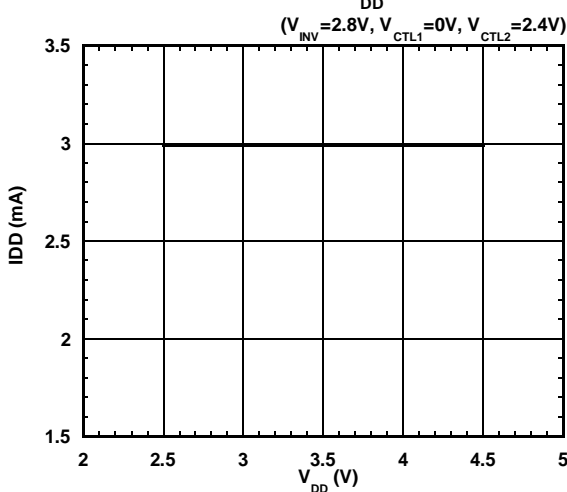

Gain, NF vs. V_{DD}

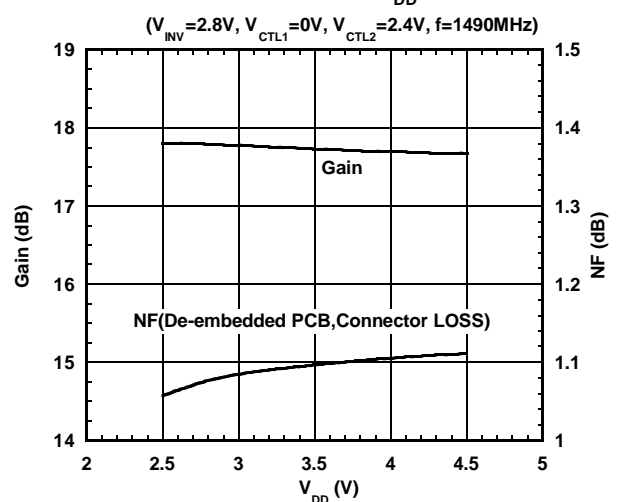

TYPICAL CHARACTERISTICS (1.5GHz Band)

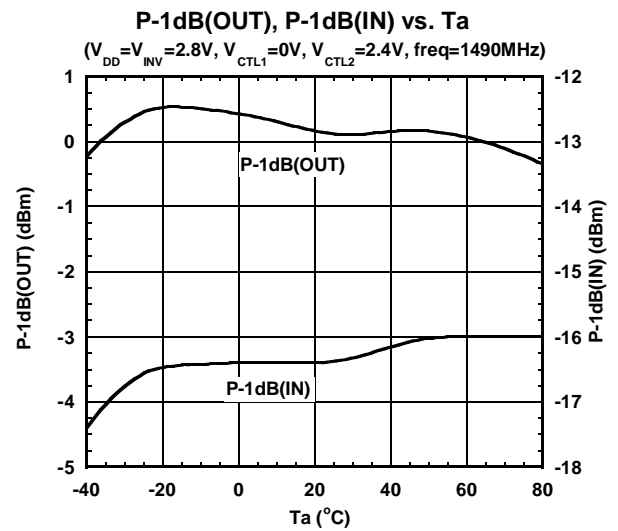
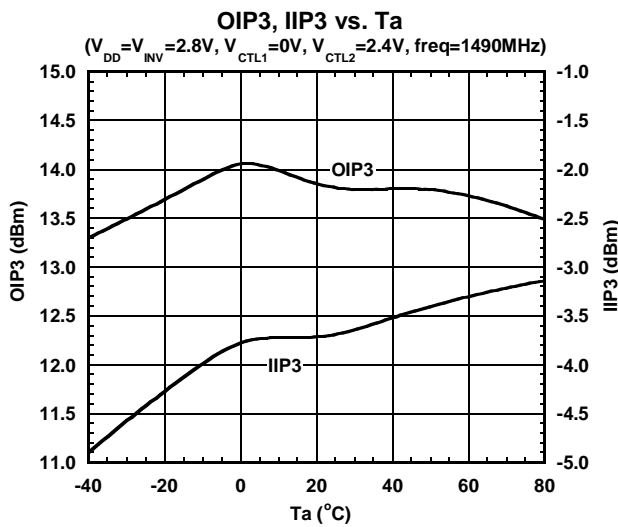
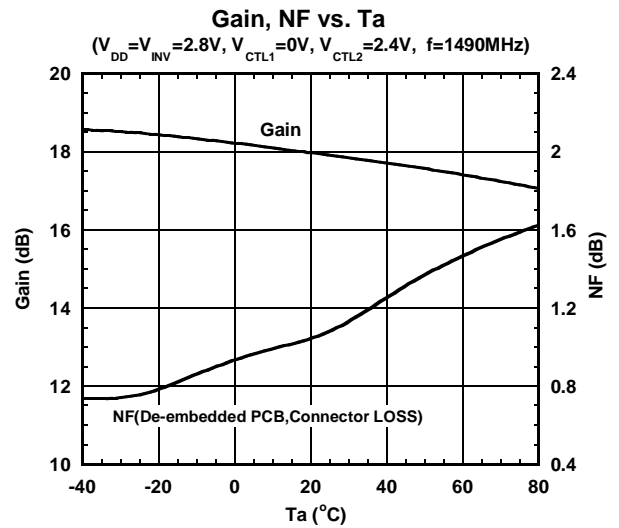
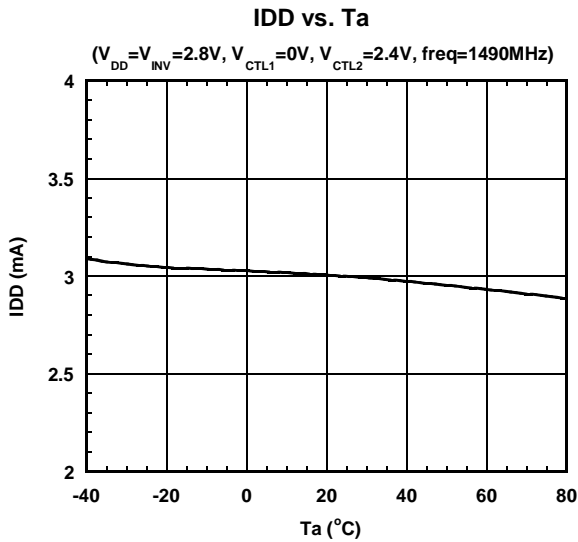
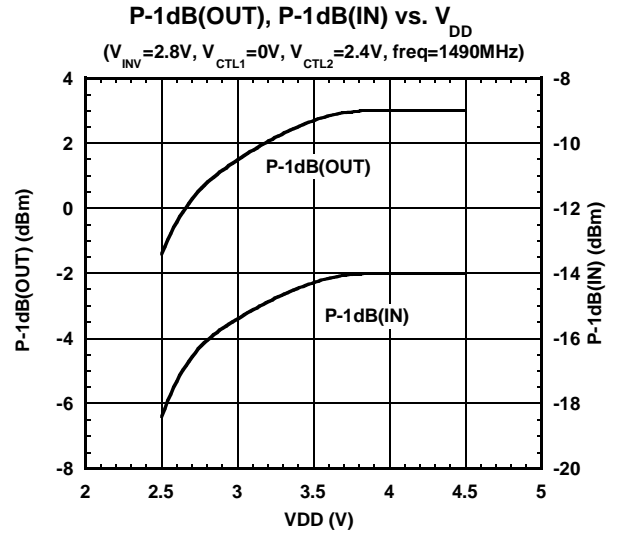
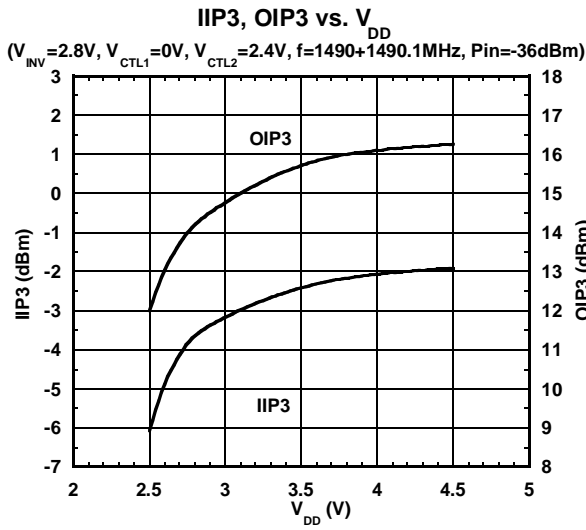

NJG112PB1

www.DataSheet4U.com

TYPICAL CHARACTERISTICS (1.5GHz Band)

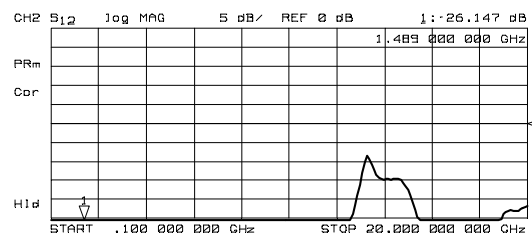
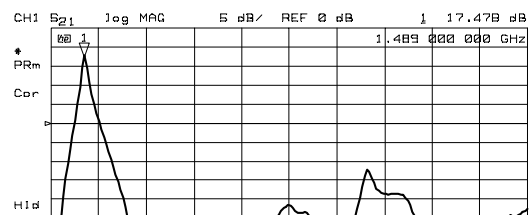
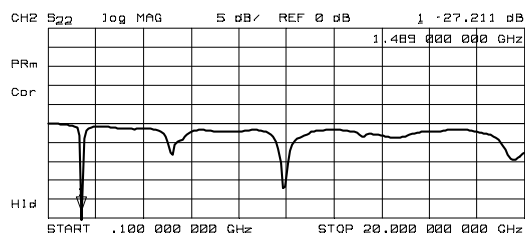
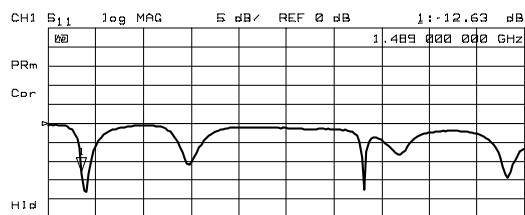
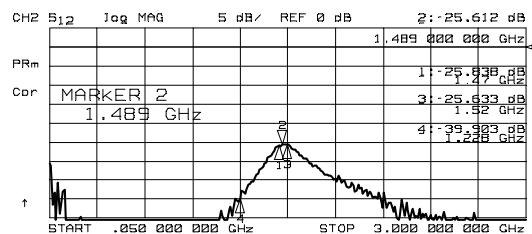
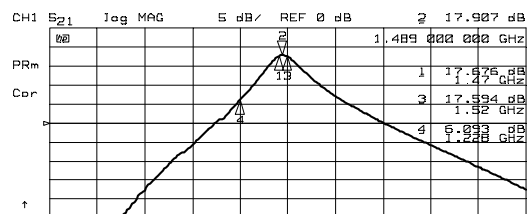
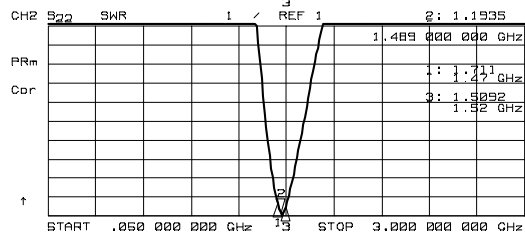
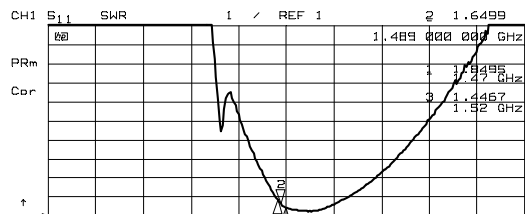
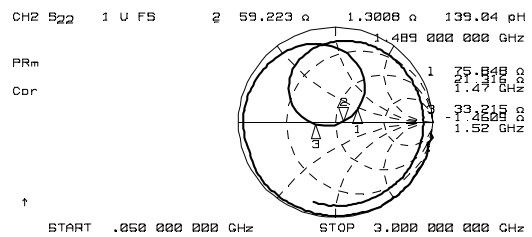
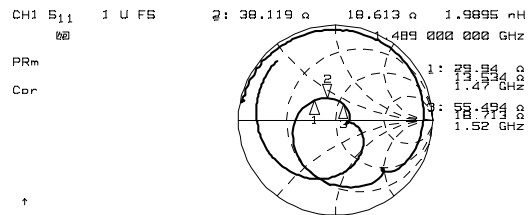
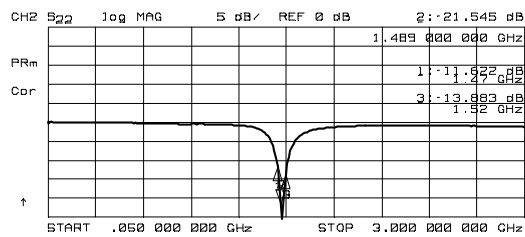
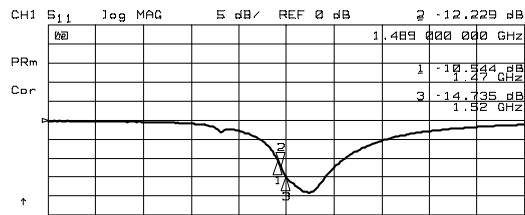

APPLICATION CIRCUIT

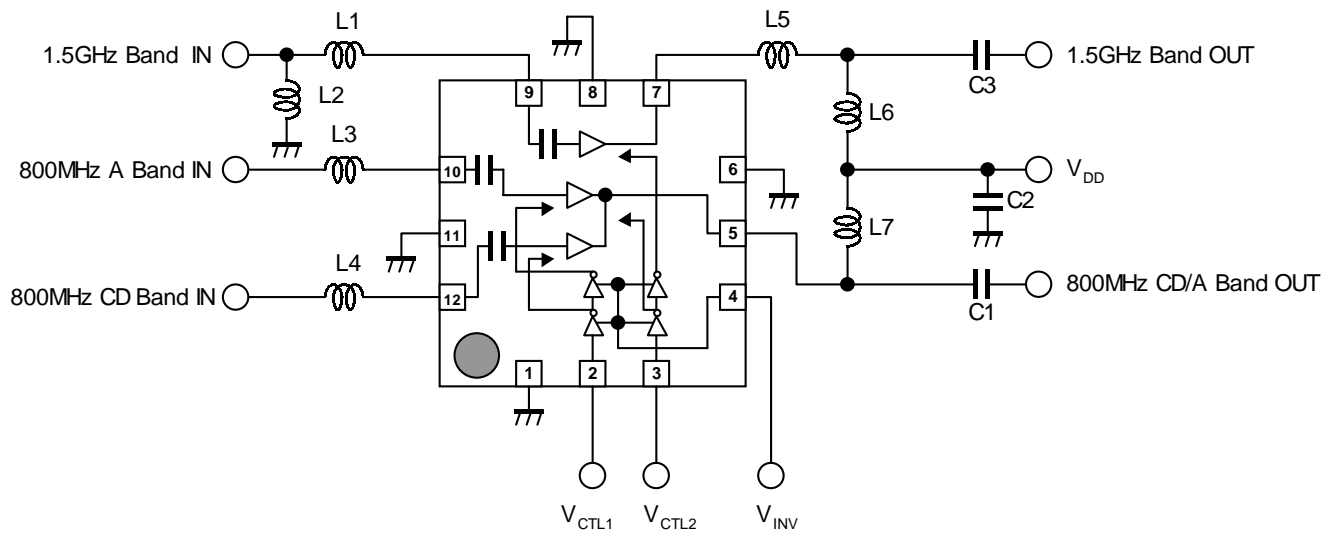

Parts list

Parts ID	CONSTANT	COMMENT
L1	10nH	TAIYO-YUDEN (HK1005, 1005size)
L2	8.2nH	TAIYO-YUDEN (HK1005, 1005size)
L3	27nH	TAIYO-YUDEN (HK1005, 1005size)
L4	33nH	TAIYO-YUDEN (HK1005, 1005size)
L5	5.6nH	TAIYO-YUDEN (HK1005, 1005size)
L6	1.5nH	TAIYO-YUDEN (HK1005, 1005size)
L7	10nH	TAIYO-YUDEN (HK1005, 1005size)
C1	1.5pF	MURATA (GRM36, 1005size)
C2	0.1uF	MURATA (GRM36, 1005size)
C3	3pF	MURATA (GRM36, 1005size)

NOTE:

- 1) All terminals other than a measured terminal are measured at 50Ω terminus.

NJG112PB1

www.DataSheet4U.com

RECOMMENDED PCB DESIGN

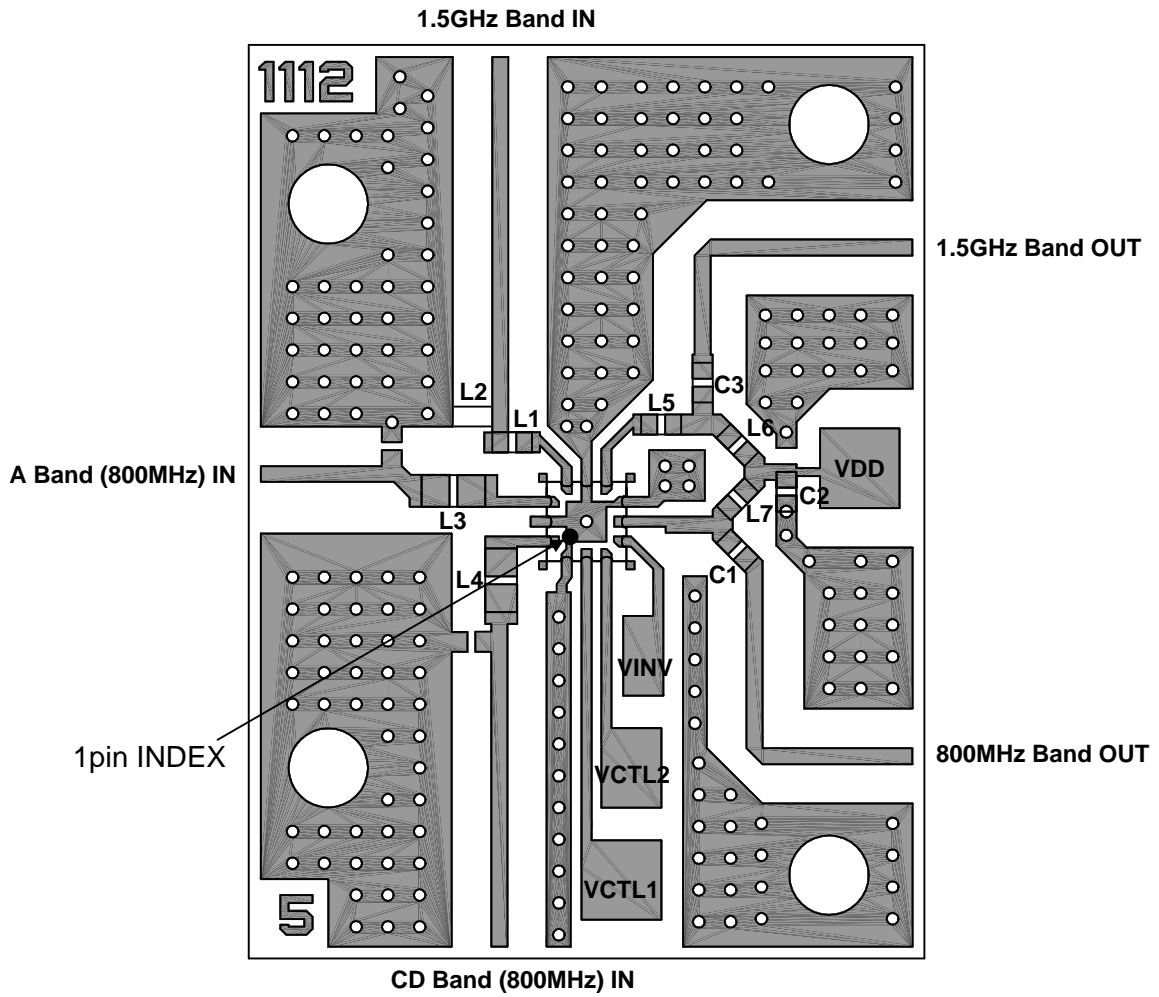

PCB (FR-4): $t=0.2\text{mm}$

MICROSTRIP LINE WIDTH= 0.4mm ($Z_0=50\Omega$)

PCB SIZE= $17\times 23\text{mm}$

PACKAGE OUTLINE (FFP12-B1)

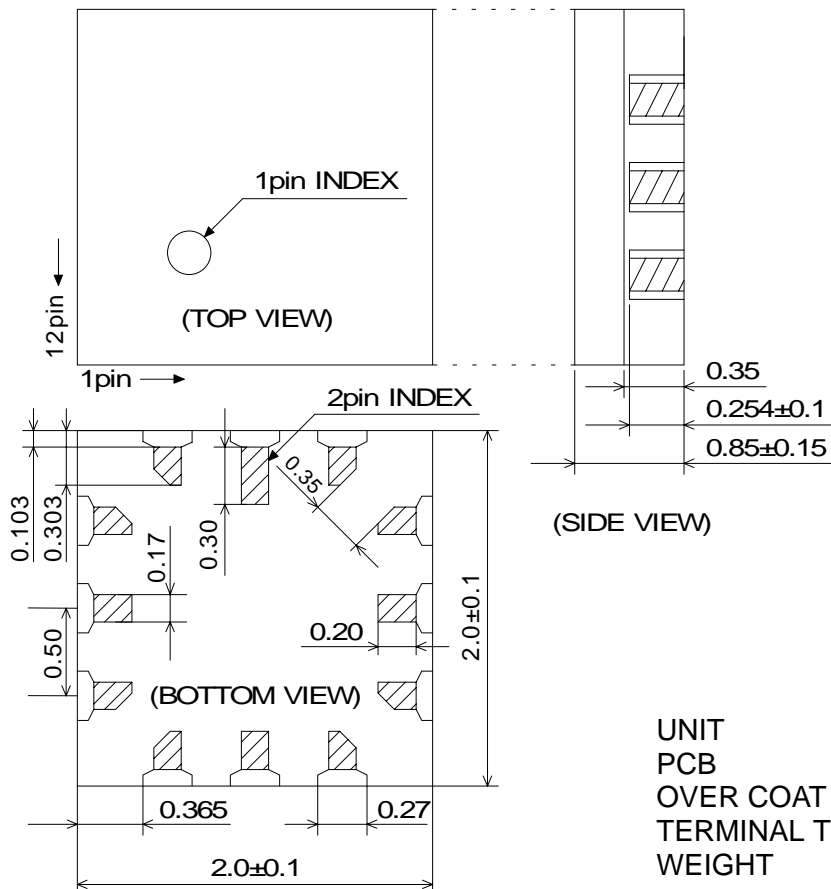

UNIT	: mm
PCB	: Ceramic
OVER COAT	: Epoxy resin
TERMINAL TREAT	: Au
WEIGHT	: 10mg

Cautions on using this product

This product contains Gallium-Arsenide (GaAs) which is a harmful material.

- Do NOT eat or put into mouth.
- Do NOT dispose in fire or break up this product.
- Do NOT chemically make gas or powder with this product.
- To waste this product, please obey the relating law of your country.

[CAUTION]

The specifications on this databook are only given for information, without any guarantee as regards either mistakes or omissions. The application circuits in this databook are described only to show representative usages of the product and not intended for the guarantee or permission of any right including the industrial rights.

This product may be damaged with electric static discharge (ESD) or spike voltage. Please handle with care to avoid these damages.