



# NJG1133MD7

## ■ABSOLUTE MAXIMUM RATINGS

$T_a=+25^{\circ}\text{C}$ ,  $Z_s=Z_l=50\Omega$

PARAMETERS	SYMBOL	CONDITIONS	RATINGS	UNITS
Operating voltage	$V_{DD}$		5.0	V
Control voltage	$V_{CTL}$	VCTL1,2,3 terminal	5.0	V
Input power	$P_{in}$		+15	dBm
Power dissipation	$P_D$	4-layer FR4 PCB with through-hole (74.2x74.2mm), $T_j=150^{\circ}\text{C}$	1300	mW
Operating temperature	$T_{opr}$		-40~+85	$^{\circ}\text{C}$
Storage temperature	$T_{stg}$		-55~+150	$^{\circ}\text{C}$

## ■ELECTRICAL CHARACTERISTICS 1 (DC CHARACTERISTICS)

General conditions:  $V_{DD}=2.8\text{V}$ ,  $T_a=+25^{\circ}\text{C}$ ,  $Z_s=Z_l=50\Omega$ , with application circuit

PARAMETERS	SYMBOL	CONDITIONS	MIN	TYP	MAX	UNITS
Operating voltage	$V_{DD}$		2.7	2.8	3.6	V
Control voltage1 (High)	$V_{CTL1(H)}$		1.36	1.8	3.6	V
Control voltage1 (Low)	$V_{CTL1(L)}$		0	0	0.3	V
Control voltage 2 (High)	$V_{CTL2(H)}$		1.36	1.8	3.6	V
Control voltage 2 (Low)	$V_{CTL2(L)}$		0	0	0.3	V
Control voltage 3 (High)	$V_{CTL3(H)}$		1.36	1.8	3.6	V
Control voltage 3 (Low)	$V_{CTL3(L)}$		0	0	0.3	V
Operating current 1 2.1GHz Band High Gain mode	$I_{DD1}$	$V_{CTL1}=0\text{V}$ , $V_{CTL2}=0\text{V}$ , $V_{CTL3}=1.8\text{V}$ , RF OFF	-	2.3	3.1	mA
Operating current 2 800MHz Band high Gain mode	$I_{DD2}$	$V_{CTL1}=1.8\text{V}$ , $V_{CTL2}=0\text{V}$ , $V_{CTL3}=1.8\text{V}$ , RF OFF	-	2.3	3.1	mA
Operating current 3 1.7GHz Band High Gain mode	$I_{DD3}$	$V_{CTL1}=0\text{V}$ , $V_{CTL2}=1.8\text{V}$ , $V_{CTL3}=1.8\text{V}$ , RF OFF	-	2.3	3.1	mA
Operating current 4 1.5GHz Band High Gain mode	$I_{DD4}$	$V_{CTL1}=1.8\text{V}$ , $V_{CTL2}=1.8\text{V}$ , $V_{CTL3}=1.8\text{V}$ , RF OFF	-	2.3	3.1	mA
Operating current 5	$I_{DD5}$	$V_{CTL3}=0\text{V}$ , RF OFF	-	48	85	$\mu\text{A}$
Control current 1	$I_{CTL1}$	$V_{CTL1}=1.8\text{V}$	-	5.5	8.5	$\mu\text{A}$
Control current 2	$I_{CTL2}$	$V_{CTL2}=1.8\text{V}$	-	5.5	8.5	$\mu\text{A}$
Control current 3	$I_{CTL3}$	$V_{CTL3}=1.8\text{V}$	-	5.5	8.5	$\mu\text{A}$

## ■ELECTRICAL CHARACTERISTICS 2 (2.1GHz Band High Gain Mode)

General conditions:  $V_{DD}=2.7V$ ,  $V_{CTL1}=0V$ ,  $V_{CTL2}=0V$ ,  $V_{CTL3}=1.8V$ ,  $f_{RF}=2140MHz$ ,  $T_a=+25^{\circ}C$ ,  $Z_s=Z_l=50\Omega$ , with application circuit

PARAMETERS	SYMBOL	CONDITIONS	MIN	TYP	MAX	UNITS
Small signal gain 1	Gain1	Exclude PCB & connector losses (IN: 0.09dB, OUT: 0.36dB)	14.5	16.0	17.5	dB
Noise figure 1	NF1	Exclude PCB & connector losses (IN: 0.09dB)	-	1.35	1.5	dB
Input Power at 1dB gain compression point 1	P-1dB(IN)_1		-15.0	-11.5	-	dBm
Input 3rd order intercept point 1	IIP3_1	$f_1=f_{RF}$ , $f_2=f_{RF}+100kHz$ , $P_{in}=-30dBm$	-9.0	+0.5	-	dBm
RF Input VSWR 1	VSWRi1		-	1.5	2.0	
RF Output VSWR 1	VSWRo1		-	2.0	2.5	

## ■ELECTRICAL CHARACTERISTICS 3 (2.1GHz Band Low Gain Mode)

General conditions:  $V_{DD}=2.7V$ ,  $V_{CTL1}=0V$ ,  $V_{CTL2}=0V$ ,  $V_{CTL3}=0V$ ,  $f_{RF}=2140MHz$ ,  $T_a=+25^{\circ}C$ ,  $Z_s=Z_l=50\Omega$ , with application circuit

PARAMETERS	SYMBOL	CONDITIONS	MIN	TYP	MAX	UNITS
Small signal gain 2	Gain2	Exclude PCB & connector losses (IN: 0.09dB, OUT: 0.36dB)	-5.0	-3.5	-2.0	dB
Noise figure 2	NF2	Exclude PCB & connector losses (IN: 0.09dB)	-	3.5	6.0	dB
Input Power at 1dB gain compression point 2	P-1dB(IN)_2		+5.0	+14.0	-	dBm
Input 3rd order intercept point 2	IIP3_2	$f_1=f_{RF}$ , $f_2=f_{RF}+100kHz$ , $P_{in}=-16dBm$	0	+12.0	-	dBm
RF Input VSWR 2	VSWRi2		-	1.6	2.0	
RF Output VSWR 2	VSWRo2		-	1.9	2.3	

# NJG1133MD7

## ■ELECTRICAL CHARACTERISTICS 4 (800MHz Band High Gain Mode)

General conditions:  $V_{DD}=2.7V$ ,  $V_{CTL1}=1.8V$ ,  $V_{CTL2}=0V$ ,  $V_{CTL3}=1.8V$ ,  $f_{RF}=885MHz$ ,  $T_a=+25^{\circ}C$ ,  
 $Z_s=Z_l=50\Omega$ , with application circuit

PARAMETERS	SYMBOL	CONDITIONS	MIN	TYP	MAX	UNITS
Small signal gain 3	Gain3	Exclude PCB & connector losses (IN: 0.06dB, OUT: 0.16dB)	14.3	16.0	17.3	dB
Noise figure 3	NF3	Exclude PCB & connector losses (IN: 0.06dB)	-	1.40	1.65	dB
Input Power at 1dB gain compression point 3	P-1dB(IN)_3		-16.0	-9.5	-	dBm
Input 3rd order intercept point 3	IIP3_3	$f1=f_{RF}$ , $f2=f_{RF}+100kHz$ , Pin=-30dBm	-10.0	-2.0	-	dBm
RF Input VSWR 3	VSWRi3		-	1.8	2.3	
RF Output VSWR 3	VSWRo3		-	2.2	2.7	

## ■ELECTRICAL CHARACTERISTICS 5 (800MHz Band Low Gain Mode)

General conditions:  $V_{DD}=2.7V$ ,  $V_{CTL1}=1.8V$ ,  $V_{CTL2}=0V$ ,  $V_{CTL3}=0V$ ,  $f_{RF}=885MHz$ ,  $T_a=+25^{\circ}C$ ,  
 $Z_s=Z_l=50\Omega$ , with application circuit

PARAMETERS	SYMBOL	CONDITIONS	MIN	TYP	MAX	UNITS
Small signal gain 4	Gain4	Exclude PCB & connector losses (IN: 0.06dB, OUT: 0.16dB)	-4.5	-3.0	-2.0	dB
Noise figure 4	NF4	Exclude PCB & connector losses (IN: 0.06dB)	-	3.0	6.0	dB
Input Power at 1dB gain compression point 4	P-1dB(IN)4		+4.5	+17.0	-	dBm
Input 3rd order intercept point 4	IIP3_4	$f1=f_{RF}$ , $f2=f_{RF}+100kHz$ , Pin=-20dBm	+2.0	+12.0	-	dBm
RF Input VSWR 4	VSWRi4		-	1.4	2.1	
RF Output VSWR 4	VSWRo4		-	1.8	2.2	

## ■ELECTRICAL CHARACTERISTICS 6 (1.7GHz Band High Gain Mode)

General conditions:  $V_{DD}=2.7V$ ,  $V_{CTL1}=0V$ ,  $V_{CTL2}=1.8V$ ,  $V_{CTL3}=1.8V$ ,  $f_{RF}=1860MHz$ ,  $T_a=+25^{\circ}C$ ,  
 $Z_s=Z_l=50\Omega$ , with application circuit

PARAMETERS	SYMBOL	CONDITIONS	MIN	TYP	MAX	UNITS
Small signal gain 5	Gain5	Exclude PCB & connector losses (IN: 0.10dB, OUT: 0.31dB)	14.5	16.0	17.5	dB
Noise figure 5	NF5	Exclude PCB & connector losses (IN: 0.10dB)	-	1.35	1.6	dB
Input Power at 1dB gain compression point 5	P-1dB(IN)_5		-16.0	-8.0	-	dBm
Input 3rd order intercept point 5	IIP3_5	$f1=f_{RF}$ , $f2=f_{RF}+100kHz$ , $P_{in}=-30dBm$	-9.0	0	-	dBm
RF Input VSWR 5	VSWRi5		-	2.1	2.6	
RF Output VSWR 5	VSWRo5		-	1.8	2.2	

## ■ELECTRICAL CHARACTERISTICS 7 (1.7GHz Band Low Gain Mode)

General conditions:  $V_{DD}=2.7V$ ,  $V_{CTL1}=0V$ ,  $V_{CTL2}=1.8V$ ,  $V_{CTL3}=0V$ ,  $f_{RF}=1860MHz$ ,  $T_a=+25^{\circ}C$ ,  
 $Z_s=Z_l=50\Omega$ , with application circuit

PARAMETERS	SYMBOL	CONDITIONS	MIN	TYP	MAX	UNITS
Small signal gain 6	Gain6	Exclude PCB & connector losses (IN: 0.10dB, OUT: 0.31dB)	-5.5	-4.0	-2.0	dB
Noise figure 6	NF6	Exclude PCB & connector losses (IN: 0.10dB)	-	4.0	6.5	dB
Input Power at 1dB gain compression point 6	P-1dB(IN)_6		+4.0	+16.0	-	dBm
Input 3rd order intercept point 6	IIP3_6	$f1=f_{RF}$ , $f2=f_{RF}+100kHz$ , $P_{in}=-16dBm$	0	+15.0	-	dBm
RF Input VSWR 6	VSWRi6		-	1.7	2.2	
RF Output VSWR 6	VSWRo6		-	2.4	2.7	

# NJG1133MD7

## ■ELECTRICAL CHARACTERISTICS 8 (1.5GHz Band High Gain Mode)

General conditions:  $V_{DD}=2.7V$ ,  $V_{CTL1}=1.8V$ ,  $V_{CTL2}=1.8V$ ,  $V_{CTL3}=1.8V$ ,  $f_{RF}=1495MHz$ ,  $T_a=+25^{\circ}C$ ,  $Z_s=Z_l=50\Omega$ , with application circuit

PARAMETERS	SYMBOL	CONDITIONS	MIN	TYP	MAX	UNITS
Small signal gain 7	Gain7	Exclude PCB & connector losses (IN: 0.09dB, OUT: 0.30dB)	14.5	16.0	18.0	dB
Noise figure 7	NF7	Exclude PCB & connector losses (IN: 0.09dB)	-	1.55	1.75	dB
Input Power at 1dB gain compression point 7	P-1dB(IN)_7		-16.0	-9.0	-	dBm
Input 3rd order intercept point 7	IIP3_7	$f1=f_{RF}$ , $f2=f_{RF}+100kHz$ , $P_{in}=-30dBm$	-6.0	0	-	dBm
RF Input VSWR 7	VSWRi7		-	2.5	2.8	
RF Output VSWR 7	VSWRo7		-	1.8	2.4	

## ■ELECTRICAL CHARACTERISTICS 9 (1.5GHz Band Low Gain Mode)

General conditions:  $V_{DD}=2.7V$ ,  $V_{CTL1}=1.8V$ ,  $V_{CTL2}=1.8V$ ,  $V_{CTL3}=0V$ ,  $f_{RF}=1495MHz$ ,  $T_a=+25^{\circ}C$ ,  $Z_s=Z_l=50\Omega$ , with application circuit

PARAMETERS	SYMBOL	CONDITIONS	MIN	TYP	MAX	UNITS
Small signal gain 8	Gain8	Exclude PCB & connector losses (IN: 0.09dB, OUT: 0.30dB)	-5.0	-3.0	-2.0	dB
Noise figure 8	NF8	Exclude PCB & connector losses (IN: 0.09dB)	-	3.0	6.0	dB
Input Power at 1dB gain compression point 8	P-1dB(IN)_8		+4.0	+16.0	-	dBm
Input 3rd order intercept point 8	IIP3_8	$f1=f_{RF}$ , $f2=f_{RF}+100kHz$ , $P_{in}=-16dBm$	0	+15.0	-	dBm
RF Input VSWR 8	VSWRi8		-	1.5	2.1	
RF Output VSWR 8	VSWRo8		-	1.8	2.3	

## ■ELECTRICAL CHARACTERISTICS 10

General conditions:  $V_{DD}=2.7V$ ,  $T_a=+25^{\circ}C$ ,  $Z_s=Z_l=50\Omega$ , with application circuit

PARAMETERS	SYMBOL	CONDITIONS	MIN	TYP	MAX	UNITS
Gain dynamic range 1 (2.1GHz Band)	GDR_1	(Gain@High Gain mode) - (Gain@Low Gain mode), $f=2140MHz$ $V_{CTL1}=0V$ , $V_{CTL2}=0V$ , $V_{CTL3}=0$ or $1.8V$	17.5	19.5	21.0	dB
Gain dynamic range 2 (800MHz Band)	GDR_2	(Gain@High Gain mode) - (Gain@Low Gain mode), $f=885MHz$ $V_{CTL1}=1.8V$ , $V_{CTL2}=0V$ , $V_{CTL3}=0$ or $1.8V$	17.5	19.0	20.5	dB
Gain dynamic range 3 (1.7GHz Band)	GDR_3	(Gain@High Gain mode) - (Gain@Low Gain mode), $f=1860MHz$ $V_{CTL1}=0V$ , $V_{CTL2}=1.8V$ , $V_{CTL3}=0$ or $1.8V$	18.0	20.0	21.5	dB
Gain dynamic range 4 (1.5GHz Band)	GDR_4	(Gain@High Gain mode) - (Gain@Low Gain mode), $f=1495MHz$ $V_{CTL1}=1.8V$ , $V_{CTL2}=1.8V$ , $V_{CTL3}=0$ or $1.8V$	17.5	19.5	21.0	dB

## ■ TRUTH TABLE

Control voltage			Operating state					
V <sub>CTL1</sub> (Band Sel1)	V <sub>CTL2</sub> (Band Sel2)	V <sub>CTL3</sub> (Gain Sel1)	2.1GHz Band		800MHz Band		1.7GHz(or 1.5GHz) Band	
			LNA	Bypass	LNA	Bypass	LNA	Bypass
L	L	L	OFF	ON	OFF	ON	OFF	ON
L	L	H	ON	OFF	OFF	OFF	OFF	OFF
H	L	L	OFF	ON	OFF	ON	OFF	ON
H	L	H	OFF	OFF	ON	OFF	OFF	OFF
L	H	L	OFF	ON	OFF	ON	OFF	ON
L	H	H	OFF	OFF	OFF	OFF	ON	OFF
H	H	L	OFF	ON	OFF	ON	OFF	ON
H	H	H	OFF	OFF	OFF	OFF	ON	OFF

“L”=0 ~ 0.30V, “H”=1.36 ~ 1.9 V

## ■ TERMINAL INFORMATION

No.	SYMBOL	DESCRIPTION
1	GND	GND terminal (0V)
2	VCTL2	Control voltage supply terminal. The frequency band (2GHz / 800MHz / 1.7GHz or 1.5GHz) is selected by 2bit control signal. (Please refer to truth table.)
3	VCTL1	
4	GND	GND terminal (0V)
5	RFOUT1	Output terminal of 800MHz band. This terminal is also the power supply terminal of the LNA, please use inductor (L3) to connect power supply.
6	RFOUT2	Output terminal of 2.1GHz band. This terminal is also the power supply terminal of the LNA, please use inductor (L6) to connect power supply.
7	RFOUT3	Output terminal of 1.7GHz(or 1.5GHz) band. This terminal is also the power supply terminal of the LNA, please use inductor (L9) to connect power supply.
8	GND	GND terminal (0V)
9	GND	GND terminal (0V)
10	RFIN3	RF input terminal of 1.7GHz(or 1.5GHz) band. The RF signal is input through external matching circuit connected to this terminal. The DC blocking capacitor is not required.
11	GND	GND terminal (0V)
12	RFIN2	RF input terminal of 2.1GHz band. The RF signal is input through external matching circuit connected to this terminal. The DC blocking capacitor is not required.
13	RFIN1	RF input terminal of 800MHz band. The RF signal is input through external matching circuit connected to this terminal. The DC blocking capacitor is not required.
14	VCTL3	Control voltage supply terminal. High gain mode or low gain mode is selected by applying this terminal.

Notes: Ground terminal (No.1, 4, 8, 9, 11) should be connected with the ground plane as short as possible.

# NJG1133MD7

## ■ELECTRICAL CHARACTERISTICS (2.1GHz band High Gain mode)

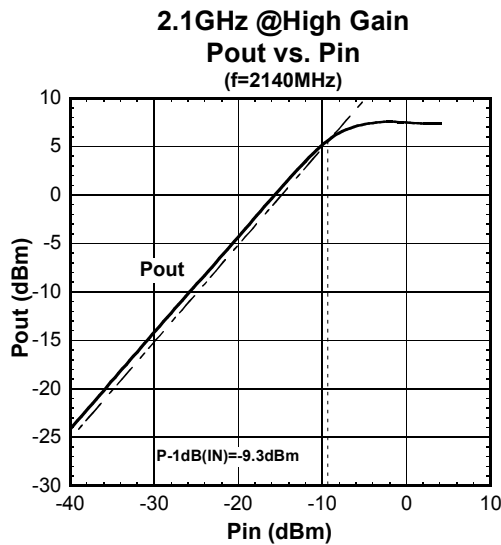

Condition  
 $T_a = +25^\circ\text{C}$ ,  
 $V_{DD} = 2.7\text{V}$ ,  
 $V_{CTL1} = 0\text{V}$ ,  $V_{CTL2} = 0\text{V}$ ,  $V_{CTL3} = 1.8\text{V}$

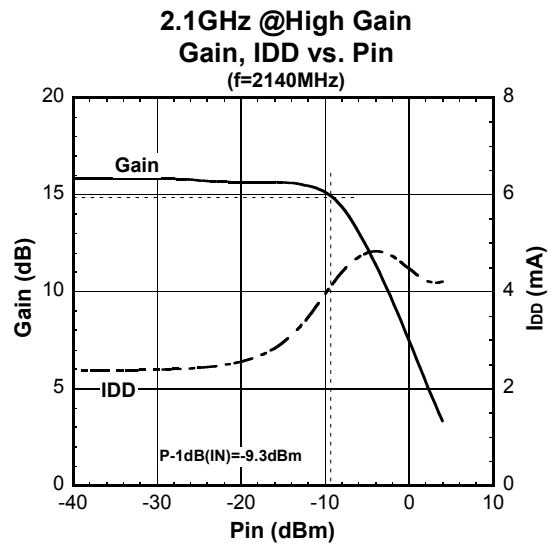

Condition  
 $T_a = +25^\circ\text{C}$ ,  
 $V_{DD} = 2.7\text{V}$ ,  
 $V_{CTL1} = 0\text{V}$ ,  $V_{CTL2} = 0\text{V}$ ,  $V_{CTL3} = 1.8\text{V}$

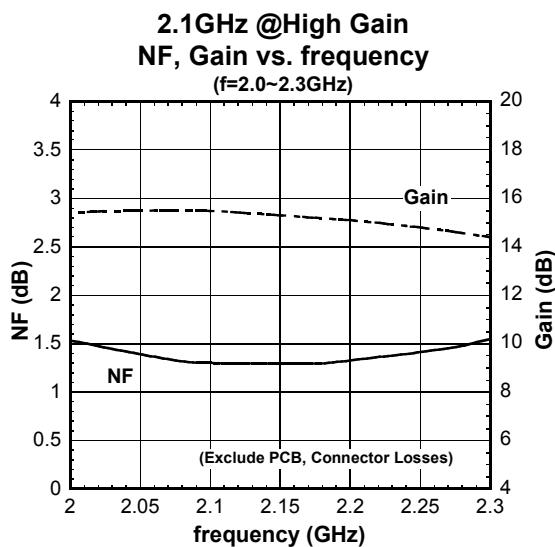

Condition  
 $T_a = +25^\circ\text{C}$ ,  
 $V_{DD} = 2.7\text{V}$ ,  
 $V_{CTL1} = 0\text{V}$ ,  $V_{CTL2} = 0\text{V}$ ,  $V_{CTL3} = 1.85\text{V}$

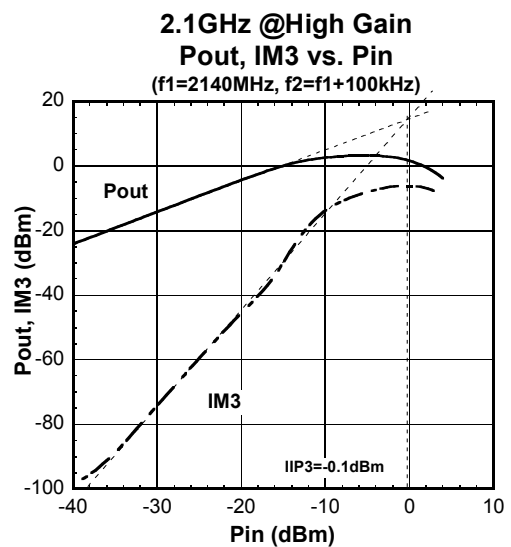

Condition  
 $T_a = +25^\circ\text{C}$ ,  
 $V_{DD} = 2.7\text{V}$ ,  
 $V_{CTL1} = 0\text{V}$ ,  $V_{CTL2} = 0\text{V}$ ,  $V_{CTL3} = 1.8\text{V}$



## ■ELECTRICAL CHARACTERISTICS (2.1GHz band High Gain mode)

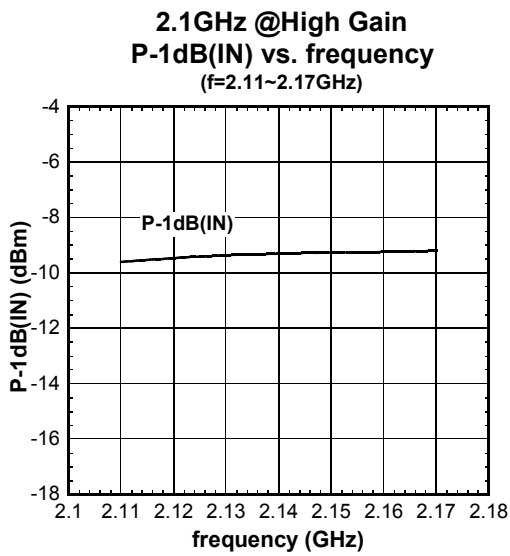

Condition

Ta=+25°C,  
V<sub>DD</sub>= 2.7V,  
V<sub>CTL1</sub>=0V, V<sub>CTL2</sub>=0V, V<sub>CTL3</sub>=1.8V

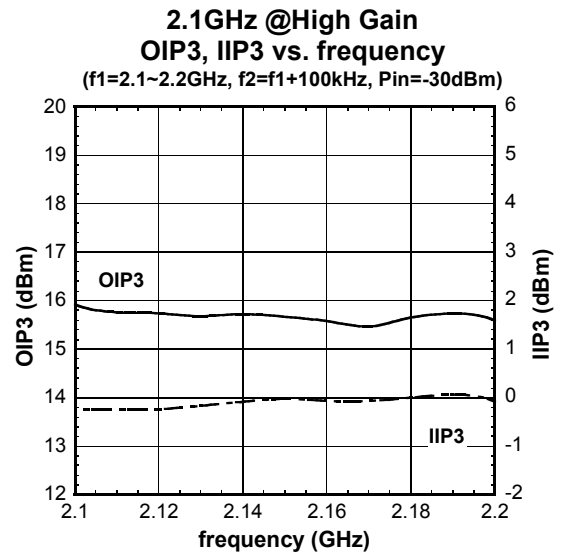

Condition

Ta=+25°C,  
V<sub>DD</sub>= 2.7V,  
V<sub>CTL1</sub>=0V, V<sub>CTL2</sub>=0V, V<sub>CTL3</sub>=1.8V

# NJG1133MD7

## ELECTRICAL CHARACTERISTICS (2.1GHz band High Gain mode)

2.1GHz @High Gain  
Gain, NF vs. V<sub>DD</sub>

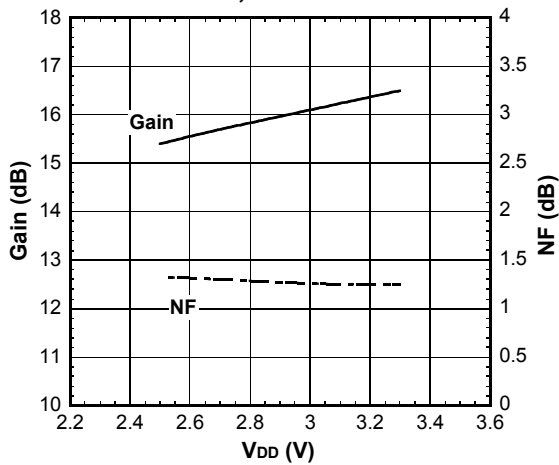

Condition  
 Ta=+25°C,  
 f=2140MHz,  
 V<sub>CTL1</sub>=0V, V<sub>CTL2</sub>=0V, V<sub>CTL3</sub>=1.8V

2.1GHz @High Gain  
OIP3, IIP3 vs. V<sub>DD</sub>

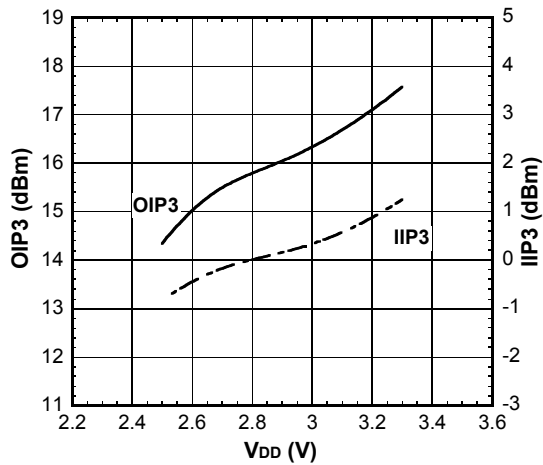

Condition  
 Ta=+25°C,  
 f1=2140MHz, f2=f1+100kHz,  
 Pin=-30dBm,  
 V<sub>CTL1</sub>=0V, V<sub>CTL2</sub>=0V, V<sub>CTL3</sub>=1.8V

2.1GHz @High Gain  
P-1dB(IN) vs. V<sub>DD</sub>

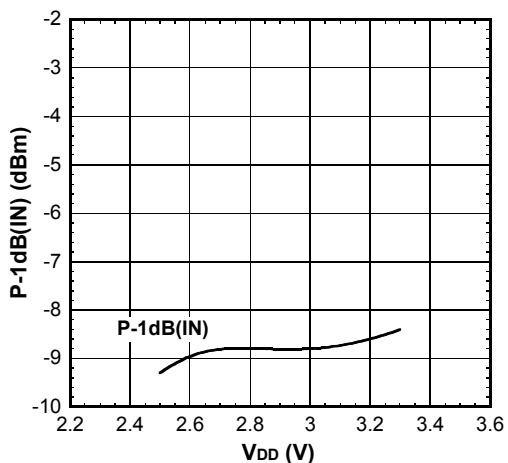

Condition  
 Ta=+25°C,  
 f=2140MHz,  
 V<sub>CTL1</sub>=0V, V<sub>CTL2</sub>=0V, V<sub>CTL3</sub>=1.8V

2.1GHz @High Gain  
VSWR vs. V<sub>DD</sub>

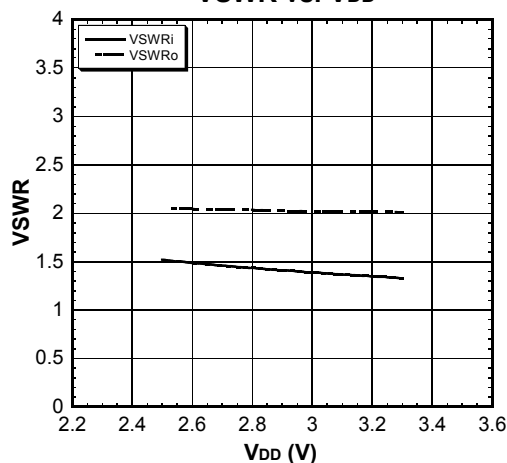

Condition  
 Ta=+25°C,  
 f=2140MHz,  
 V<sub>CTL1</sub>=0V, V<sub>CTL2</sub>=0V, V<sub>CTL3</sub>=1.8V

## ■ ELECTRICAL CHARACTERISTICS (2.1GHz band High Gain mode)

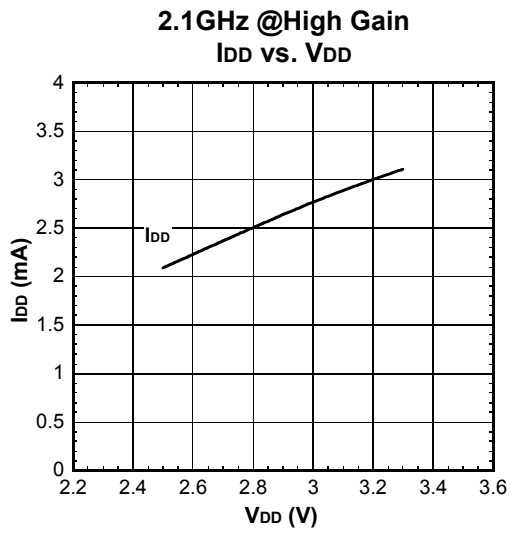

Condition

T<sub>a</sub>=+25°C,

RF=OFF,

V<sub>CTL1</sub>=0V, V<sub>CTL2</sub>=0V, V<sub>CTL3</sub>=1.8V

# NJG1133MD7

## ■ ELECTRICAL CHARACTERISTICS (2.1GHz band High Gain mode)

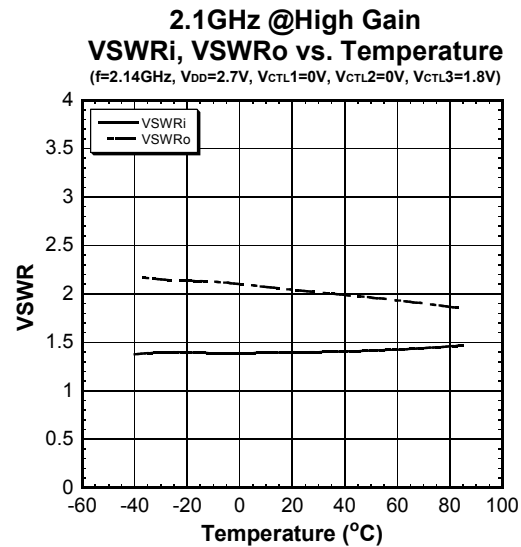
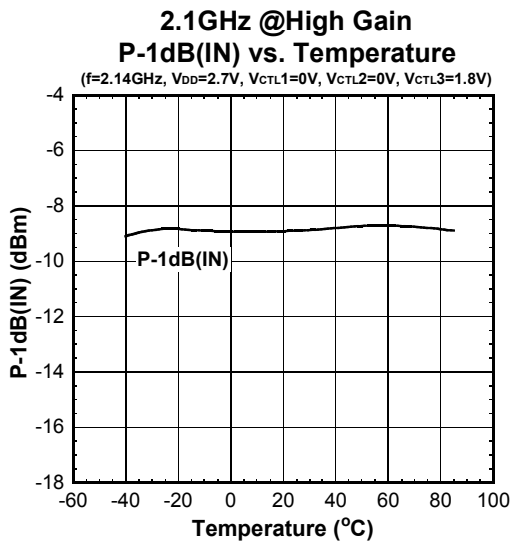
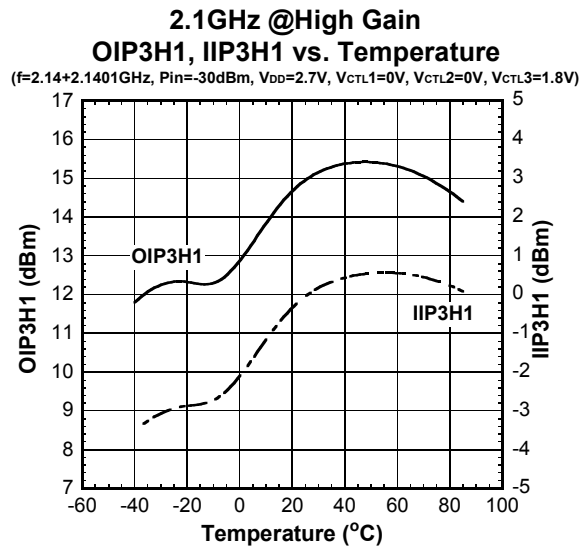
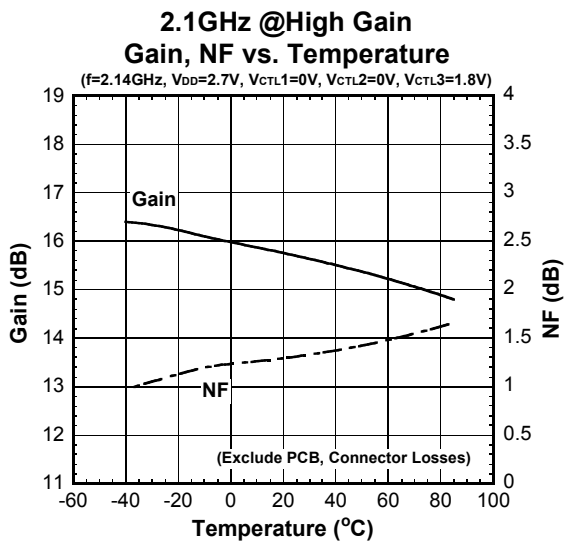

## ■ ELECTRICAL CHARACTERISTICS (2.1GHz band High Gain mode)

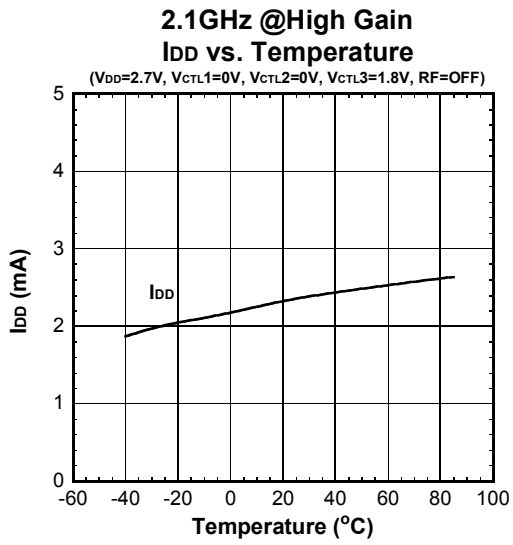

# NJG1133MD7

## ELECTRICAL CHARACTERISTICS (2.1GHz band High Gain mode)

Condition : Ta=+25°C, V<sub>DD</sub>=2.7V, V<sub>CTL1</sub>=0V, V<sub>CTL2</sub>=0V, V<sub>CTL3</sub>=1.8V

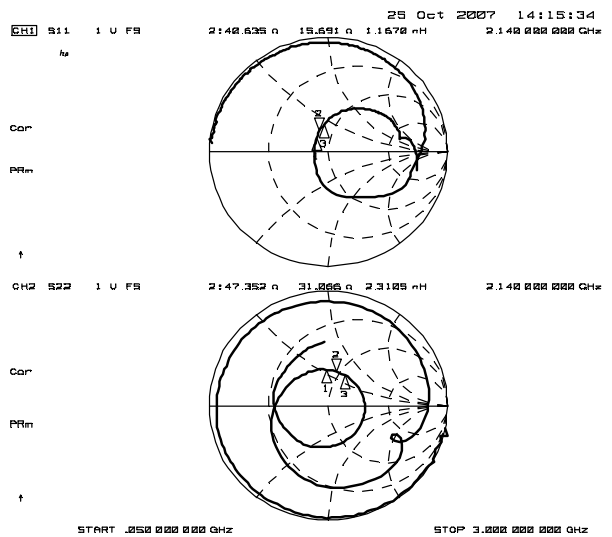
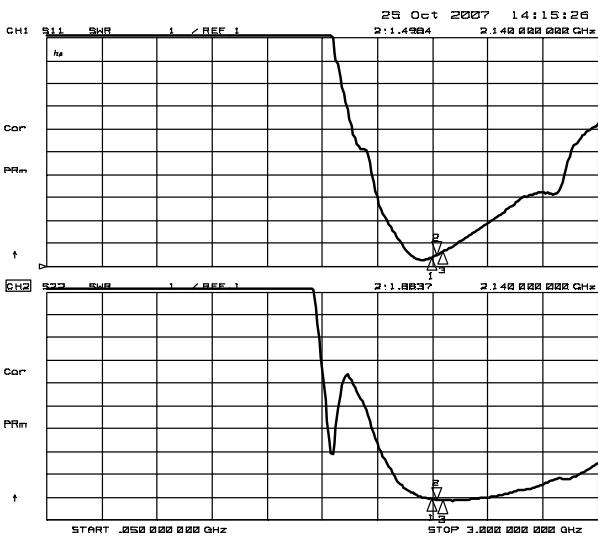
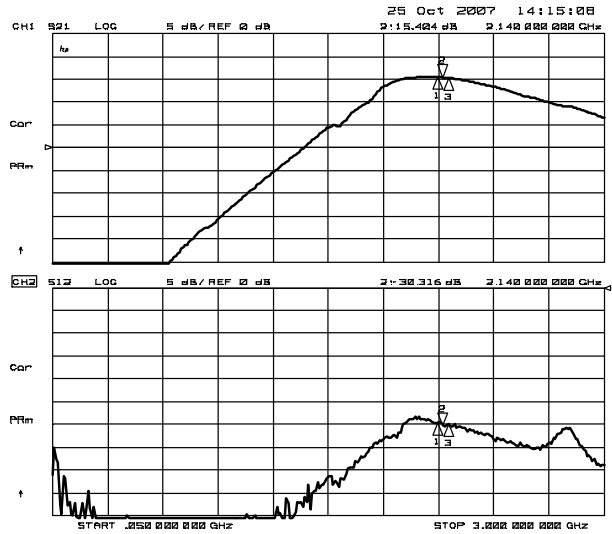
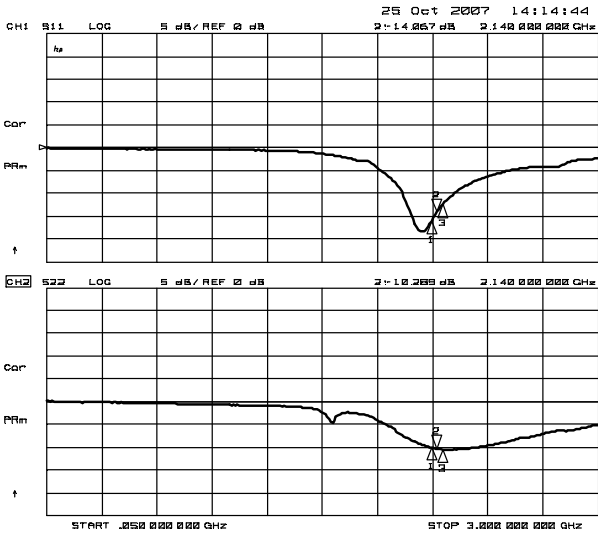

## ■ ELECTRICAL CHARACTERISTICS (2.1GHz band High Gain mode)

Condition : Ta=+25°C, V<sub>DD</sub>= 2.7V, V<sub>CTL1</sub>=0V, V<sub>CTL2</sub>=0V, V<sub>CTL3</sub>=1.8V

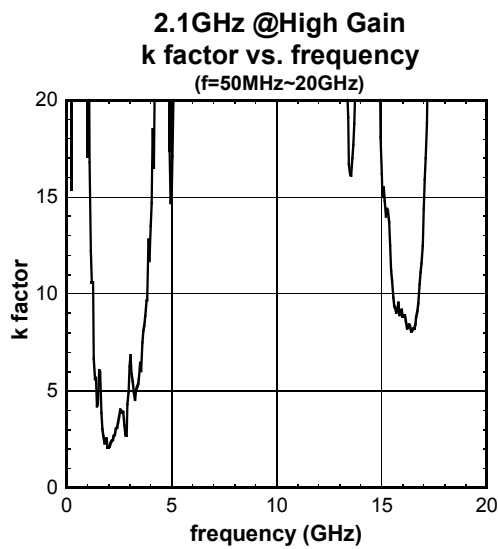
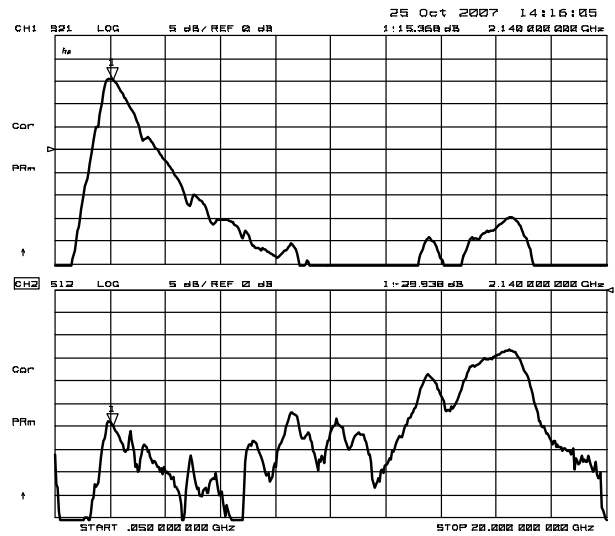
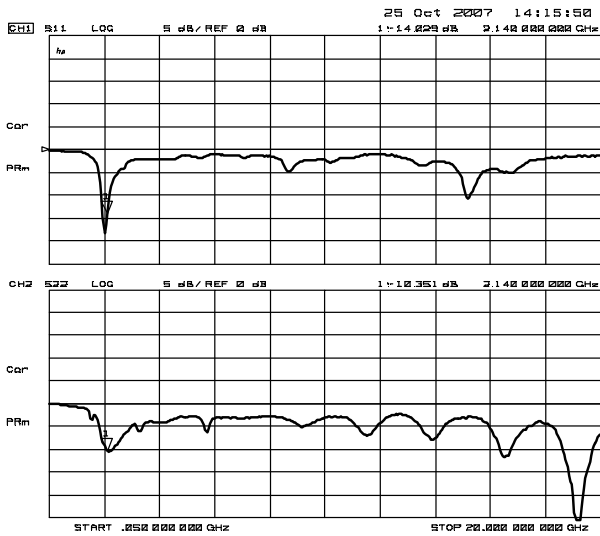

# NJG1133MD7

## ■ ELECTRICAL CHARACTERISTICS (2.1GHz band Low Gain mode)

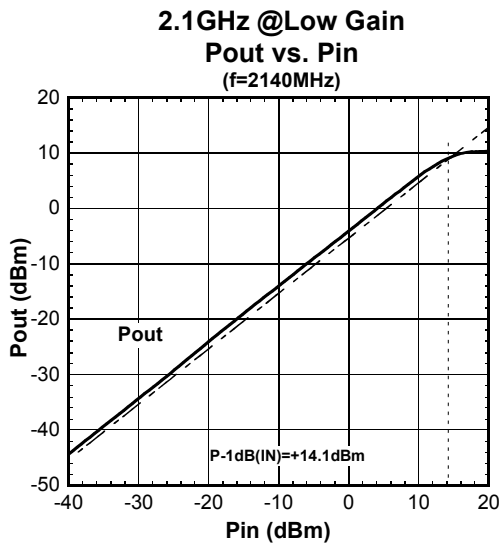

Condition  
 $T_a = +25^\circ\text{C}$ ,  
 $V_{DD} = 2.7\text{V}$ ,  
 $V_{CTL1} = 0\text{V}$ ,  $V_{CTL2} = 0\text{V}$ ,  $V_{CTL3} = 0\text{V}$

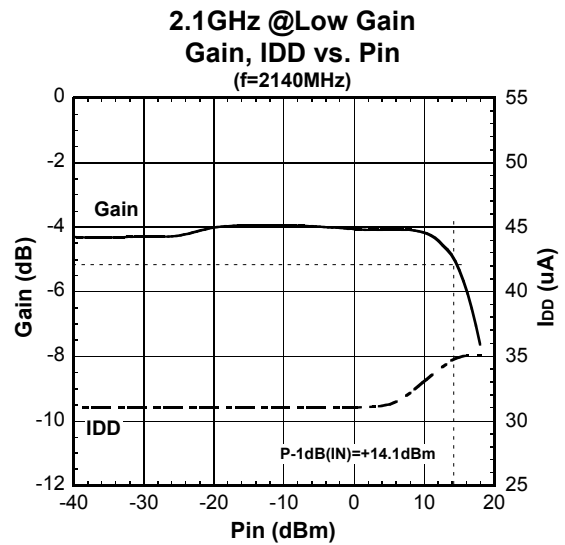

Condition  
 $T_a = +25^\circ\text{C}$ ,  
 $V_{DD} = 2.7\text{V}$ ,  
 $V_{CTL1} = 0\text{V}$ ,  $V_{CTL2} = 0\text{V}$ ,  $V_{CTL3} = 0\text{V}$

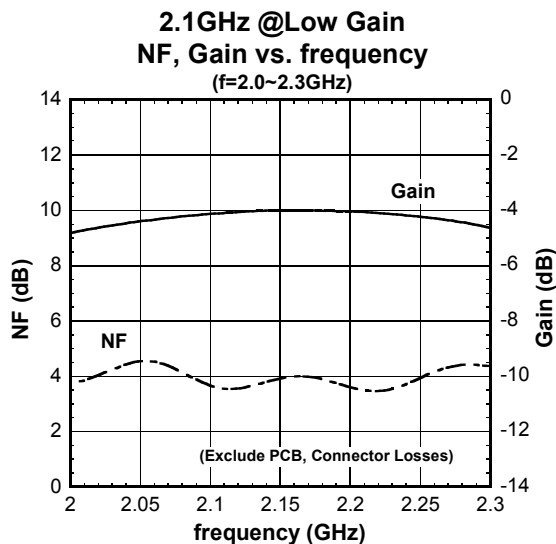

Condition  
 $T_a = +25^\circ\text{C}$ ,  
 $V_{DD} = 2.7\text{V}$ ,  
 $V_{CTL1} = 0\text{V}$ ,  $V_{CTL2} = 0\text{V}$ ,  $V_{CTL3} = 0\text{V}$

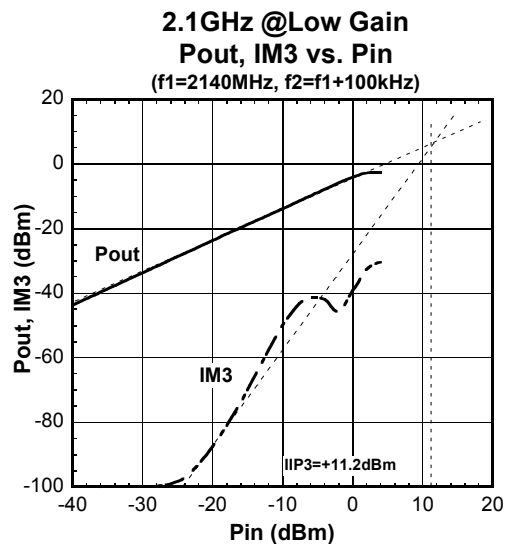

Condition  
 $T_a = +25^\circ\text{C}$ ,  
 $V_{DD} = 2.7\text{V}$ ,  
 $V_{CTL1} = 0\text{V}$ ,  $V_{CTL2} = 0\text{V}$ ,  $V_{CTL3} = 0\text{V}$



## ■ ELECTRICAL CHARACTERISTICS (2.1GHz band Low Gain mode)

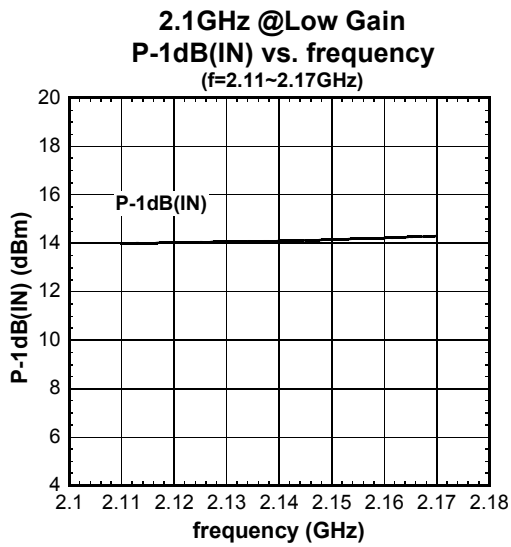

Condition

Ta=+25°C,

V<sub>DD</sub>= 2.7V,

V<sub>CTL1</sub>=0V, V<sub>CTL2</sub>=0V, V<sub>CTL3</sub>=0V

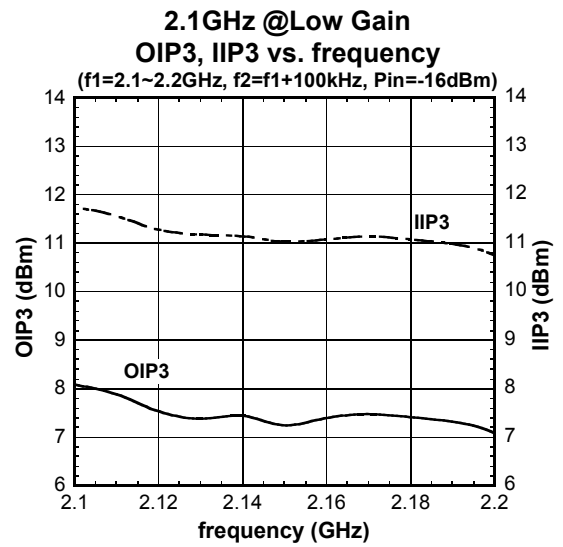

Condition

Ta=+25°C,

V<sub>DD</sub>= 2.7V,

V<sub>CTL1</sub>=0V, V<sub>CTL2</sub>=0V, V<sub>CTL3</sub>=0V

# NJG1133MD7

## ELECTRICAL CHARACTERISTICS (2.1GHz band Low Gain mode)

2.1GHz @Low Gain  
Gain, NF vs. V<sub>DD</sub>

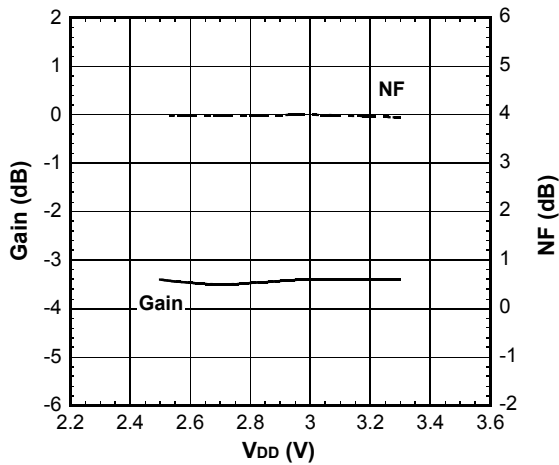

Condition  
 Ta=+25°C,  
 f=2140MHz,  
 V<sub>CTL1</sub>=0V, V<sub>CTL2</sub>=0V, V<sub>CTL3</sub>=0V

2.1GHz @Low Gain  
OIP3, IIP3 vs. V<sub>DD</sub>

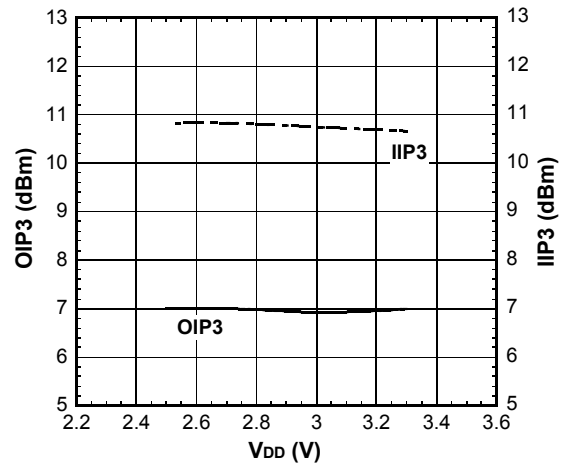

Condition  
 Ta=+25°C,  
 f1=2140MHz, f2=f1+100kHz,  
 Pin=-16dBm,  
 V<sub>CTL1</sub>=0V, V<sub>CTL2</sub>=0V, V<sub>CTL3</sub>=0V

2.1GHz @Low Gain  
P-1dB(IN) vs. V<sub>DD</sub>

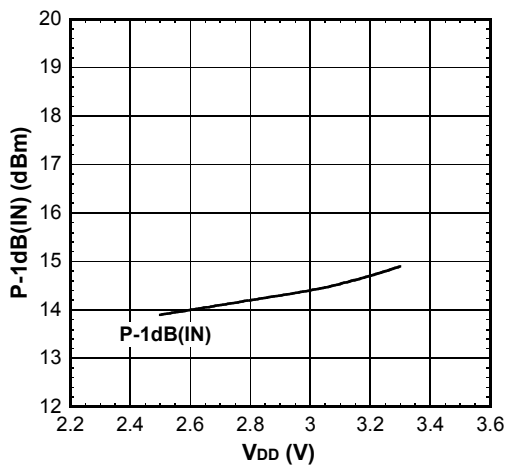

Condition  
 Ta=+25°C,  
 f=2140MHz,  
 V<sub>CTL1</sub>=0V, V<sub>CTL2</sub>=0V, V<sub>CTL3</sub>=0V

2.1GHz @Low Gain  
VSWR vs. V<sub>DD</sub>

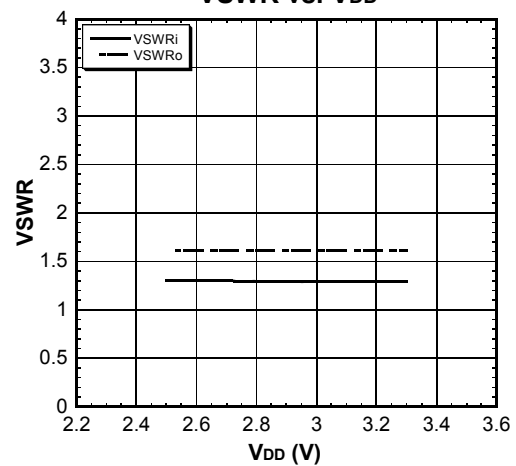

Condition  
 Ta=+25°C,  
 f=2140MHz,  
 V<sub>CTL1</sub>=0V, V<sub>CTL2</sub>=0V, V<sub>CTL3</sub>=0V

## ■ELECTRICAL CHARACTERISTICS (2.1GHz band Low Gain mode)

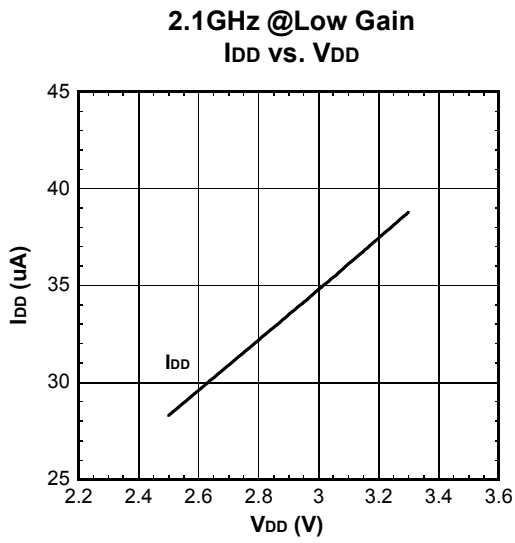

Condition

T<sub>a</sub>=+25°C,

RF=OFF,

V<sub>CTL1</sub>=0V, V<sub>CTL2</sub>=0V, V<sub>CTL3</sub>=0V

# NJG1133MD7

## ■ ELECTRICAL CHARACTERISTICS (2.1GHz band Low Gain mode)

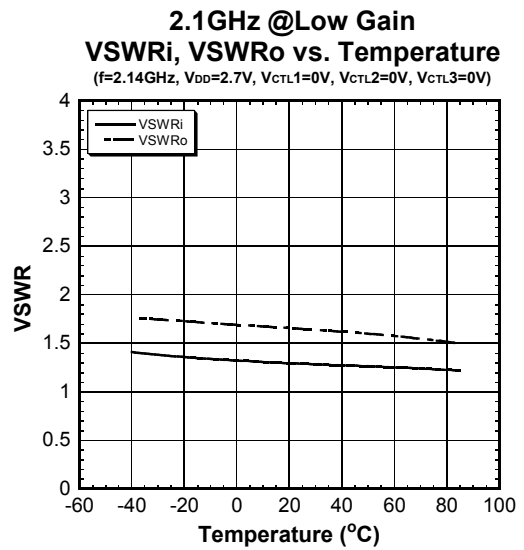
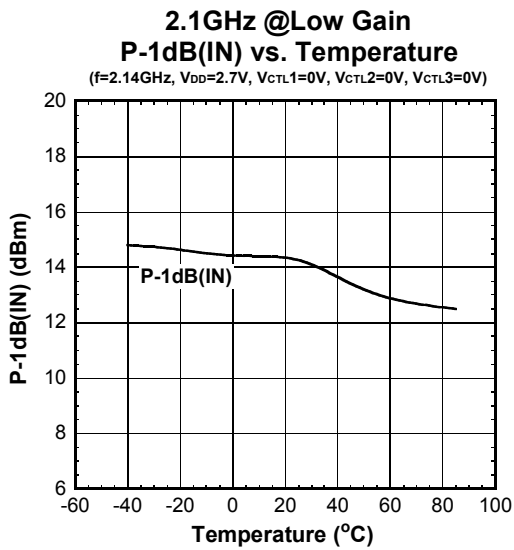
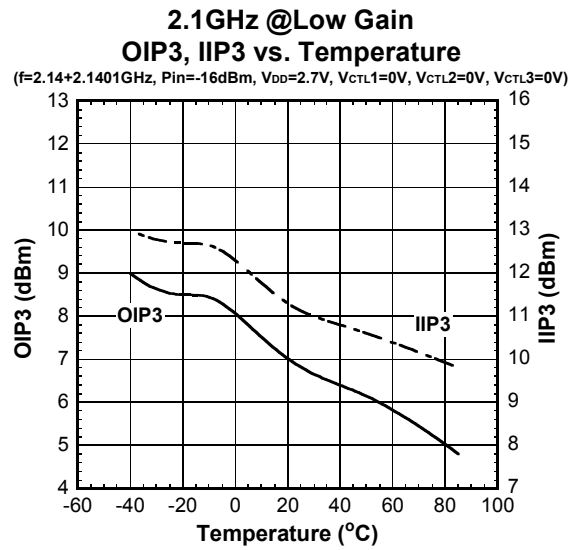
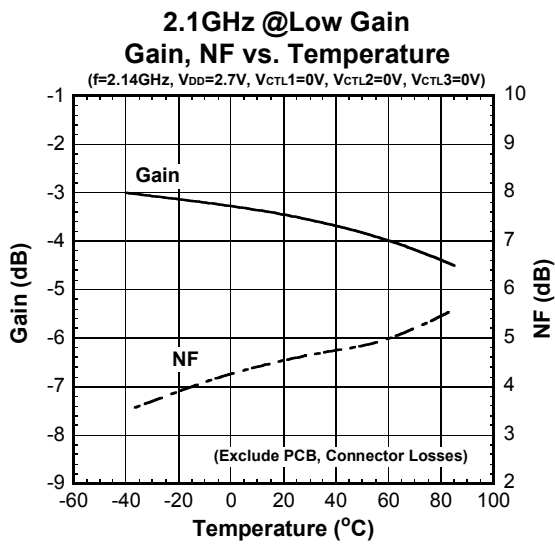

## ■ ELECTRICAL CHARACTERISTICS (2.1GHz band Low Gain mode)

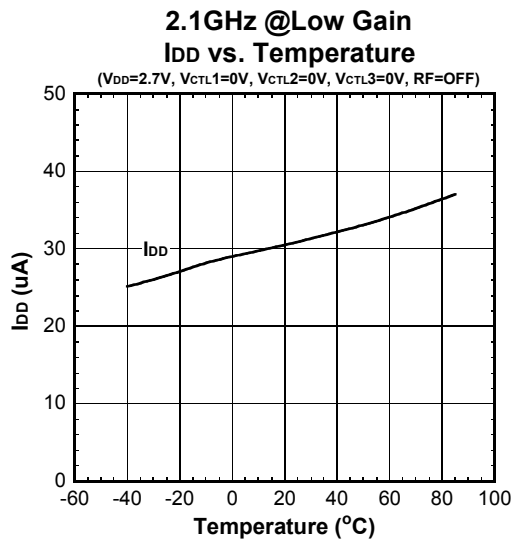

# NJG1133MD7

## ELECTRICAL CHARACTERISTICS (2.1GHz band Low Gain mode)

Condition : Ta=+25°C, V<sub>DD</sub>=2.7V, V<sub>CTL1</sub>=0V, V<sub>CTL2</sub>=0V, V<sub>CTL3</sub>=0V

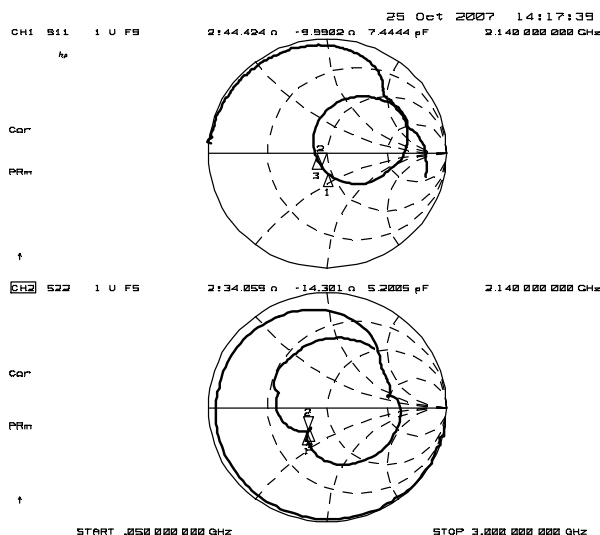
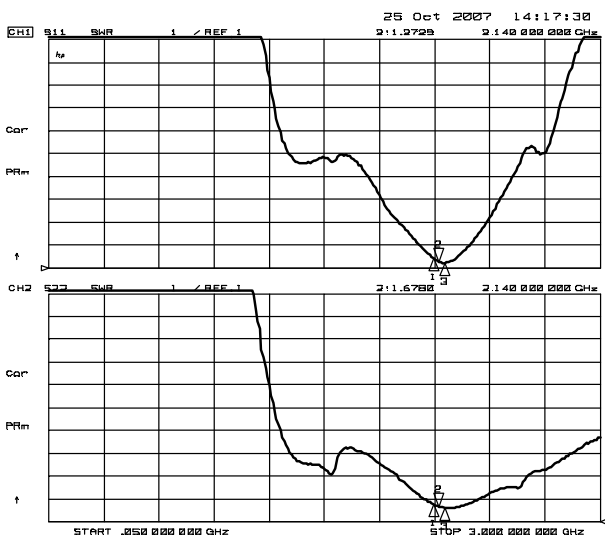
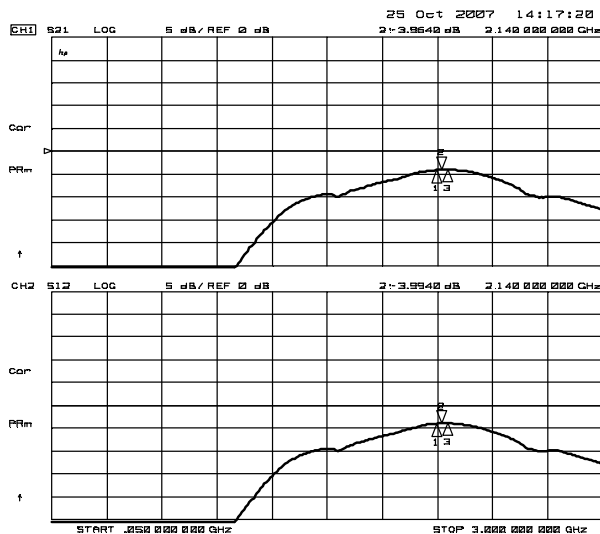
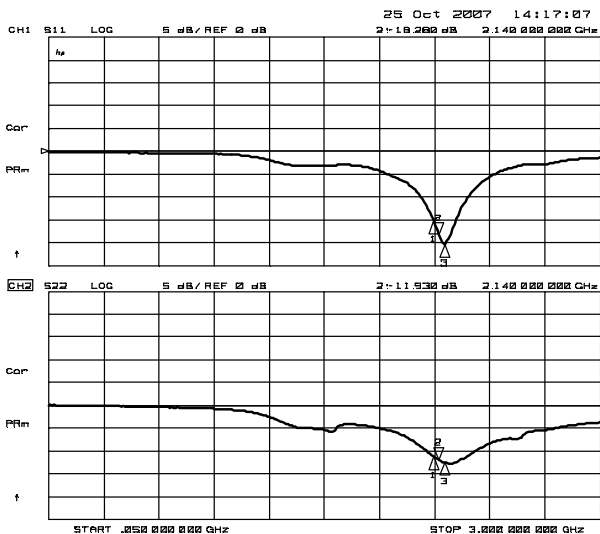

## ■ELECTRICAL CHARACTERISTICS (2.1GHz band Low Gain mode)

Condition : Ta=+25°C, V<sub>DD</sub>= 2.7V, V<sub>CTL1</sub>=0V, V<sub>CTL2</sub>=0V, V<sub>CTL3</sub>=0V

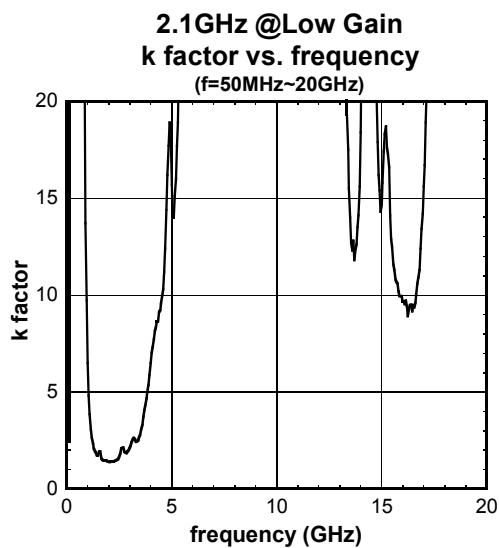
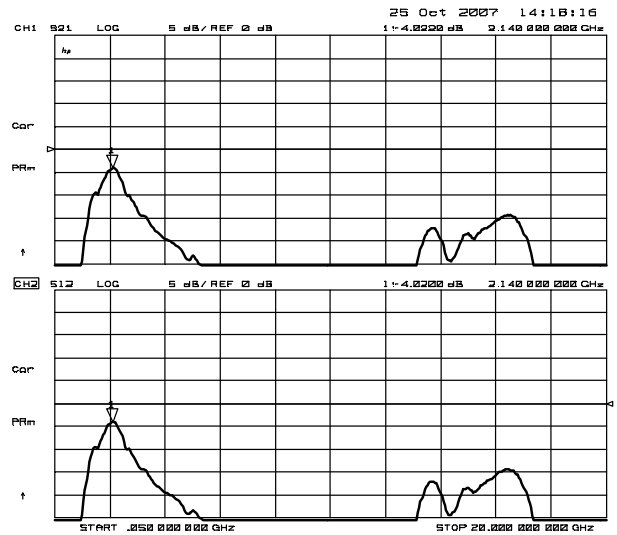
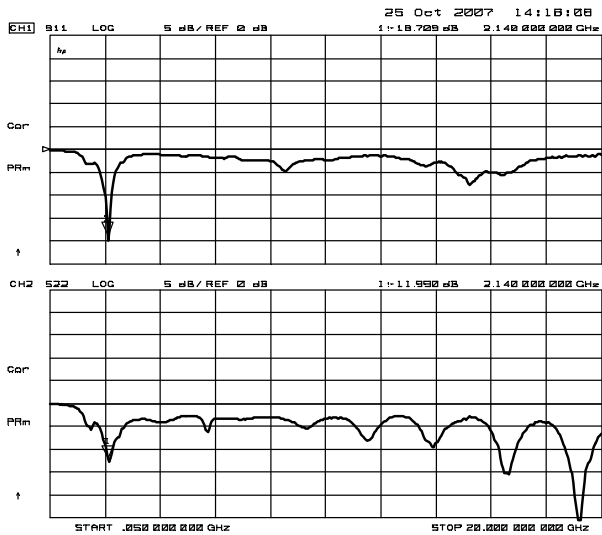

# NJG1133MD7

## ■ ELECTRICAL CHARACTERISTICS (800MHz band High Gain mode)

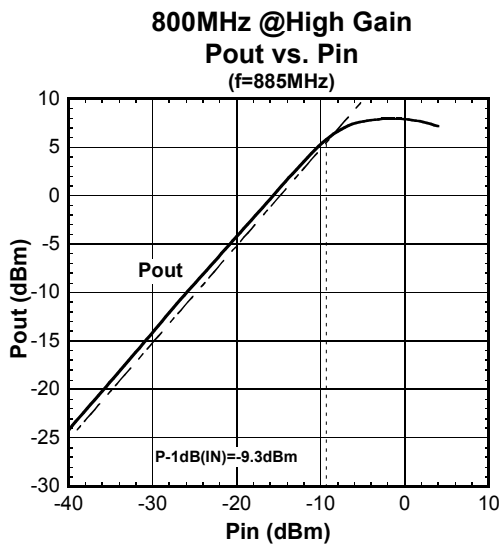

Condition  
 $T_a = +25^\circ\text{C}$ ,  
 $V_{DD} = 2.7\text{V}$ ,  
 $V_{CTL1} = 1.8\text{V}$ ,  $V_{CTL2} = 0\text{V}$ ,  $V_{CTL3} = 1.8\text{V}$

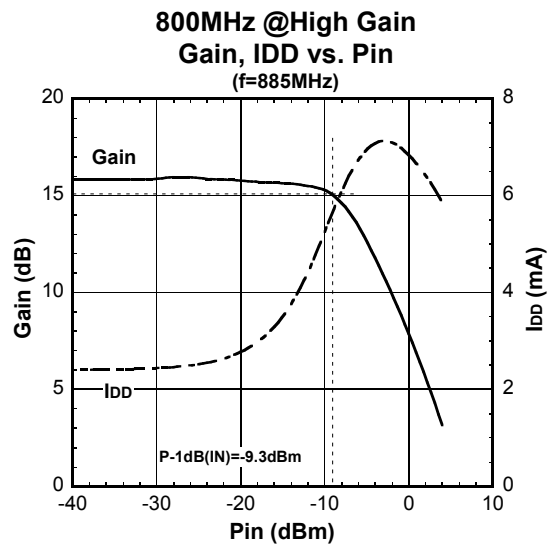

Condition  
 $T_a = +25^\circ\text{C}$ ,  
 $V_{DD} = 2.7\text{V}$ ,  
 $V_{CTL1} = 1.8\text{V}$ ,  $V_{CTL2} = 0\text{V}$ ,  $V_{CTL3} = 1.8\text{V}$

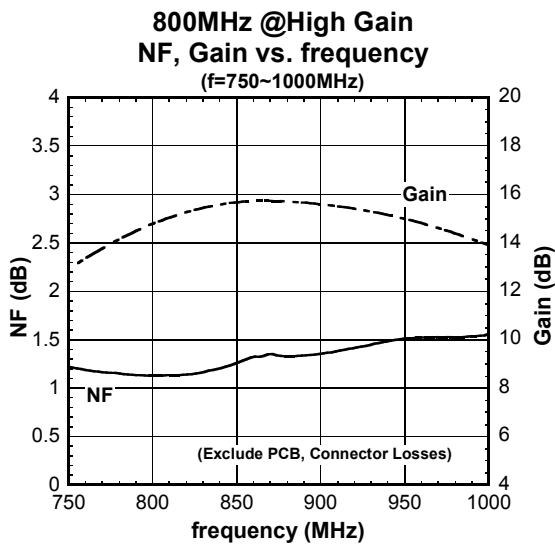

Condition  
 $T_a = +25^\circ\text{C}$ ,  
 $V_{DD} = 2.7\text{V}$ ,  
 $V_{CTL1} = 1.8\text{V}$ ,  $V_{CTL2} = 0\text{V}$ ,  $V_{CTL3} = 1.8\text{V}$

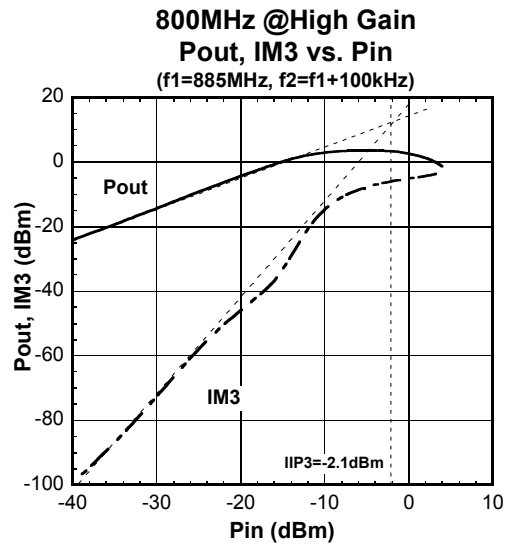

Condition  
 $T_a = +25^\circ\text{C}$ ,  
 $V_{DD} = 2.7\text{V}$ ,  
 $V_{CTL1} = 1.8\text{V}$ ,  $V_{CTL2} = 0\text{V}$ ,  $V_{CTL3} = 1.8\text{V}$



## ■ ELECTRICAL CHARACTERISTICS (800MHz band High Gain mode)

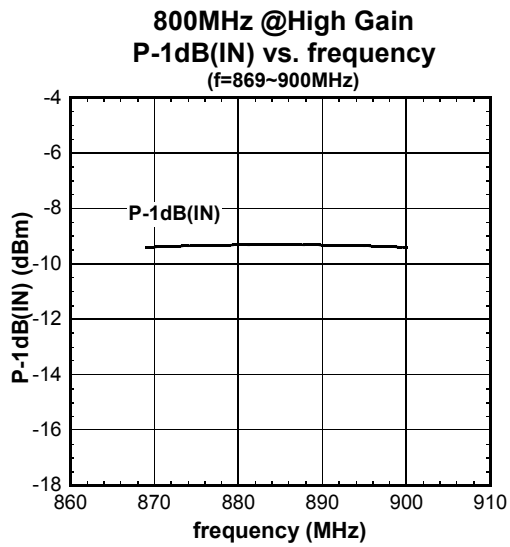

Condition

Ta=+25°C,

V<sub>DD</sub>= 2.7V,

V<sub>CTL1</sub>=1.8V, V<sub>CTL2</sub>=0V, V<sub>CTL3</sub>=1.8V

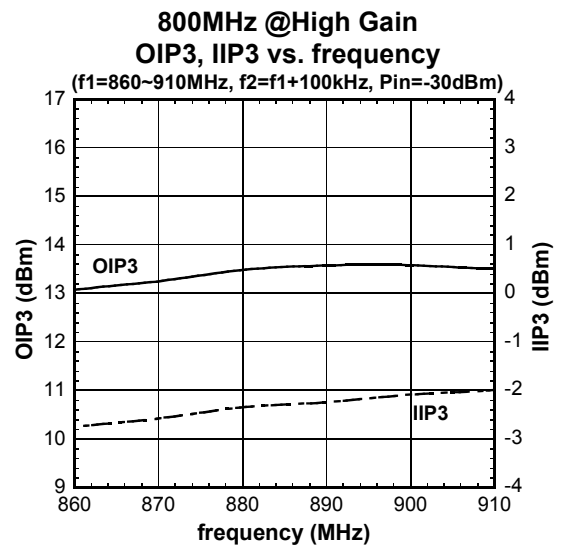

Condition

Ta=+25°C,

V<sub>DD</sub>= 2.7V,

V<sub>CTL1</sub>=1.8V, V<sub>CTL2</sub>=0V, V<sub>CTL3</sub>=1.8V

# NJG1133MD7

## ■ELECTRICAL CHARACTERISTICS (800MHz band High Gain mode)

800MHz @High Gain  
Gain, NF vs. V<sub>DD</sub>

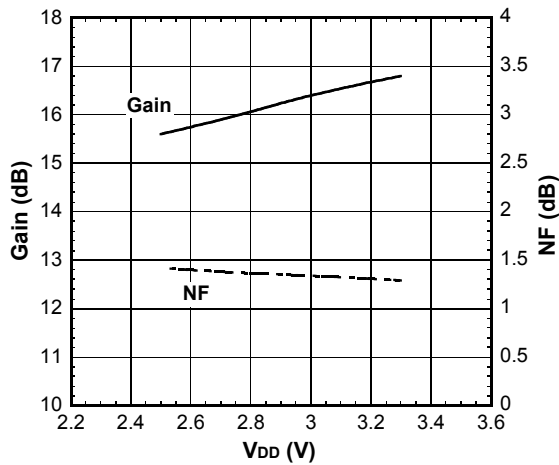

Condition

T<sub>a</sub>=+25°C,  
f=885MHz,  
V<sub>CTL1</sub>=1.8V, V<sub>CTL2</sub>=0V, V<sub>CTL3</sub>=1.8V

800MHz @High Gain  
OIP3, IIP3 vs. V<sub>DD</sub>

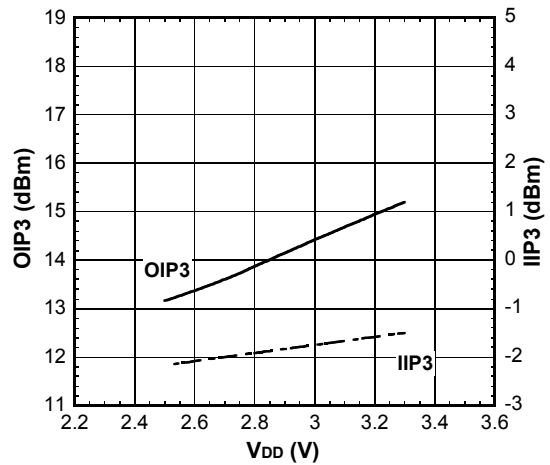

Condition

T<sub>a</sub>=+25°C,  
f<sub>1</sub>=885MHz, f<sub>2</sub>=f<sub>1</sub>+100kHz,  
Pin=-30dBm,  
V<sub>CTL1</sub>=1.8V, V<sub>CTL2</sub>=0V, V<sub>CTL3</sub>=1.8V

800MHz @High Gain  
P-1dB(IN) vs. V<sub>DD</sub>

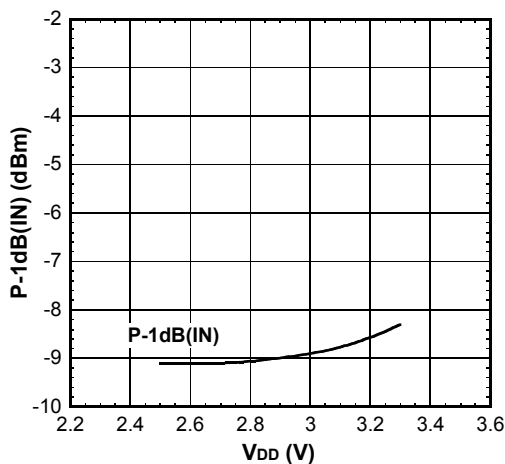

Condition

T<sub>a</sub>=+25°C,  
f=885MHz,  
V<sub>CTL1</sub>=1.8V, V<sub>CTL2</sub>=0V, V<sub>CTL3</sub>=1.8V

800MHz @High Gain  
VSWR vs. V<sub>DD</sub>

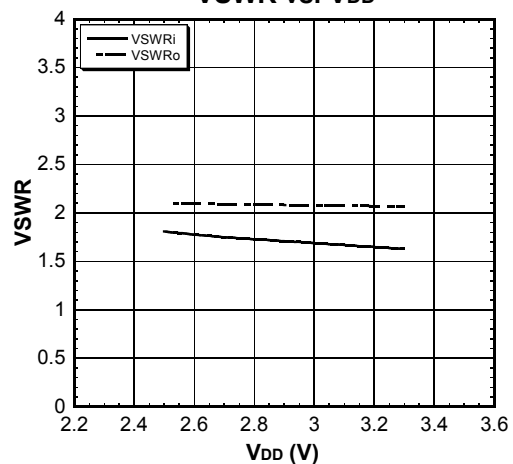

Condition

T<sub>a</sub>=+25°C,  
f=885MHz,  
V<sub>CTL1</sub>=1.8V, V<sub>CTL2</sub>=0V, V<sub>CTL3</sub>=1.8V

## ■ ELECTRICAL CHARACTERISTICS (800MHz band High Gain mode)

800MHz @High Gain  
I<sub>DD</sub> vs. V<sub>DD</sub>

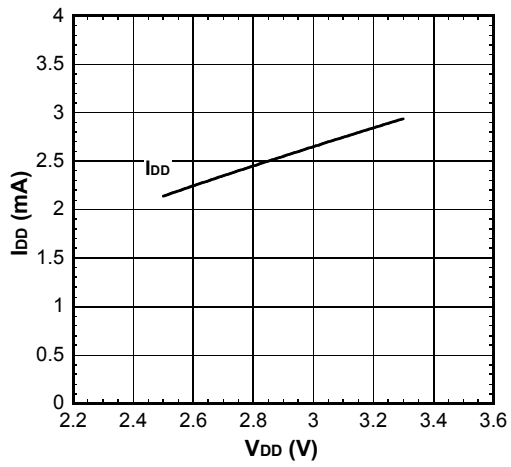

Condition

T<sub>a</sub>=+25°C,

RF=OFF

V<sub>CTL1</sub>=1.8V, V<sub>CTL2</sub>=0V, V<sub>CTL3</sub>=1.8V

# NJG1133MD7

## ■ ELECTRICAL CHARACTERISTICS (800MHz band High Gain mode)

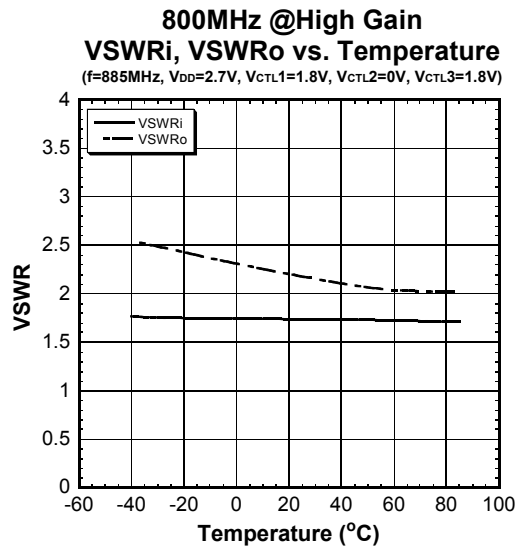
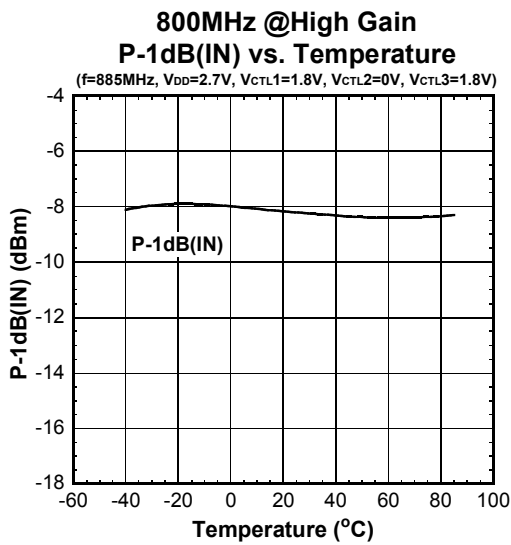
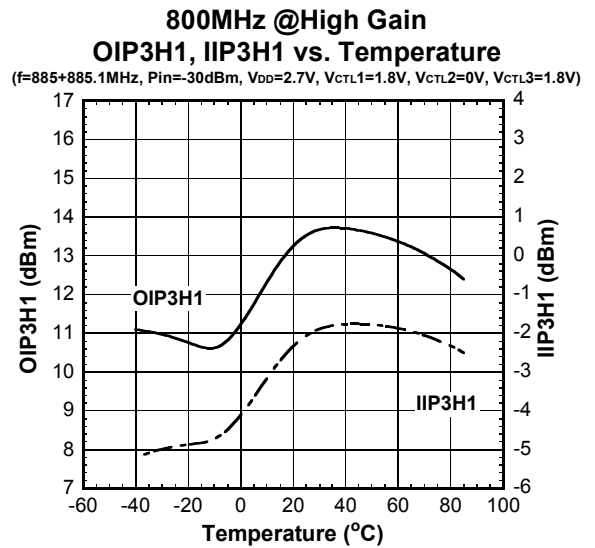
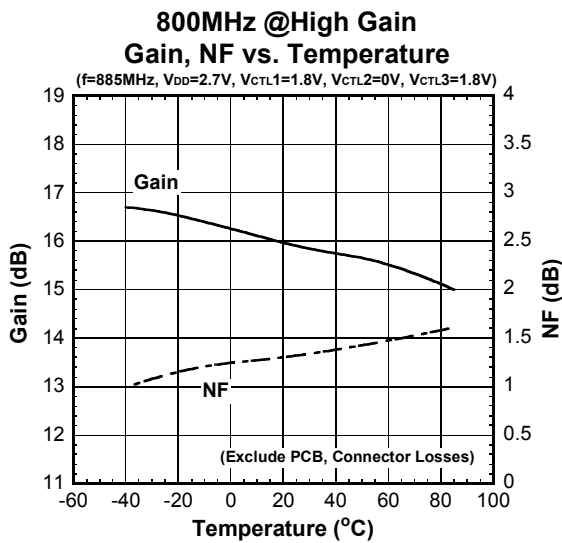

## ■ ELECTRICAL CHARACTERISTICS (800MHz band High Gain mode)

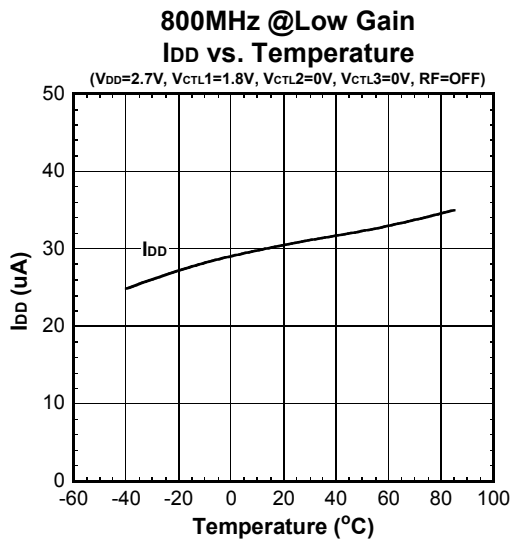

# NJG1133MD7

## ELECTRICAL CHARACTERISTICS (800MHz band High Gain mode)

Condition : Ta=+25°C, V<sub>DD</sub>= 2.7V, V<sub>CTL1</sub>=1.8V, V<sub>CTL2</sub>=0V, V<sub>CTL3</sub>=1.8V

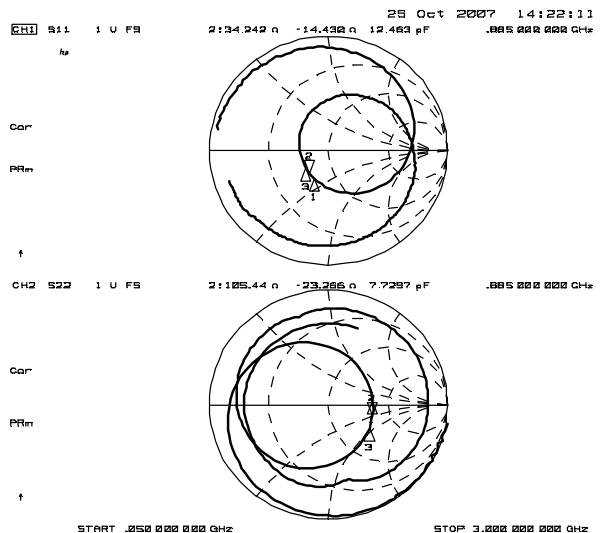
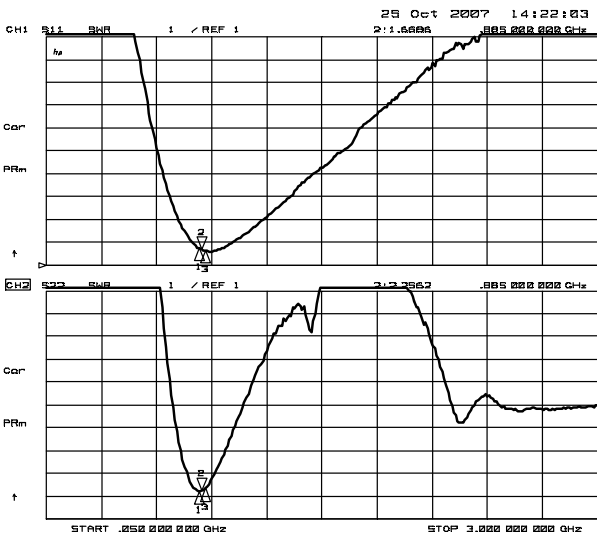
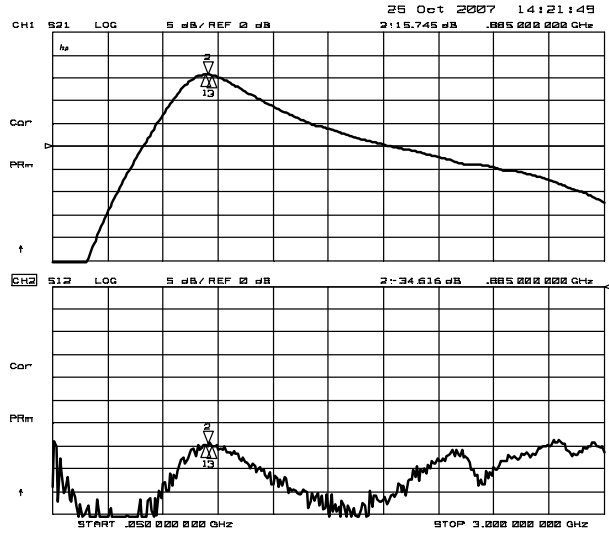
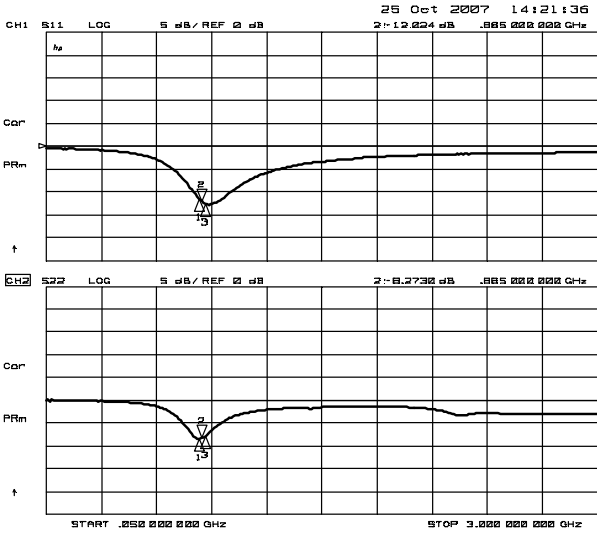

## ELECTRICAL CHARACTERISTICS (800MHz band High Gain mode)

Condition :  $T_a = +25^\circ\text{C}$ ,  $V_{DD} = 2.7\text{V}$ ,  $V_{CTL1} = 1.8\text{V}$ ,  $V_{CTL2} = 0\text{V}$ ,  $V_{CTL3} = 1.8\text{V}$

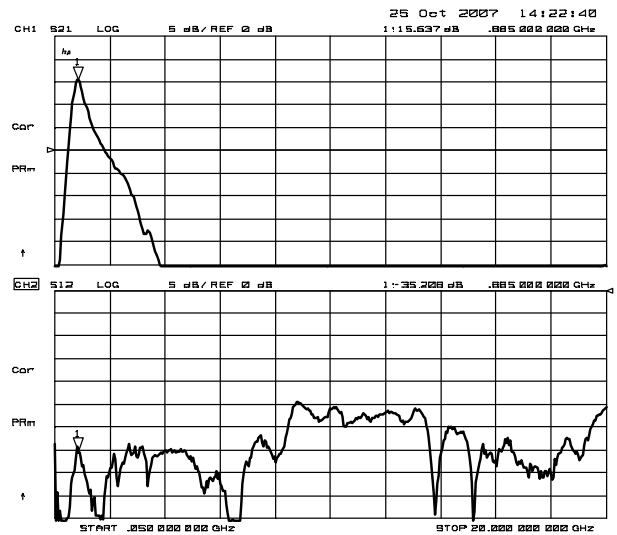
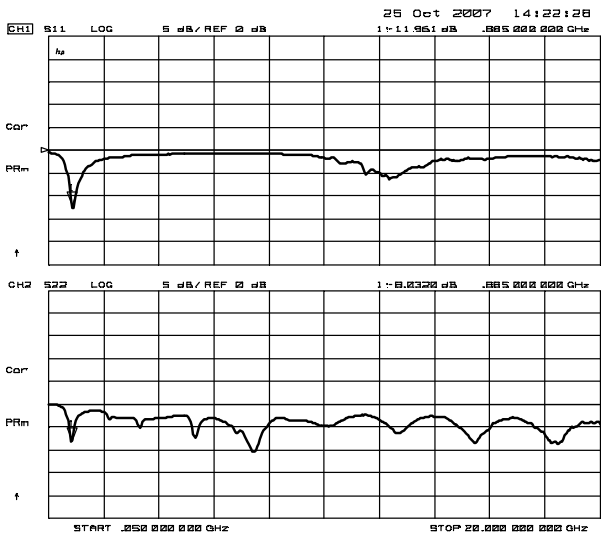

**800MHz @High Gain**  
**k factor vs. frequency**  
 (f=50MHz~20GHz)

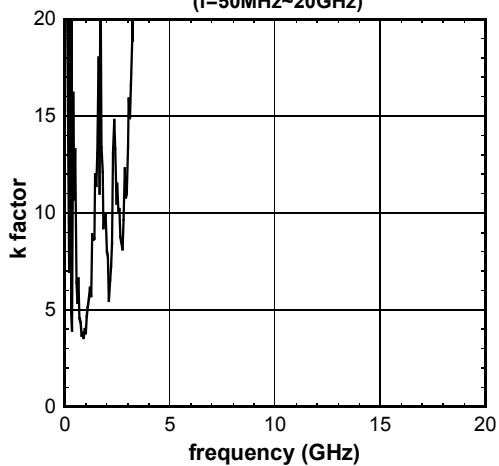

# NJG1133MD7

## ■ ELECTRICAL CHARACTERISTICS (800MHz band Low Gain mode)

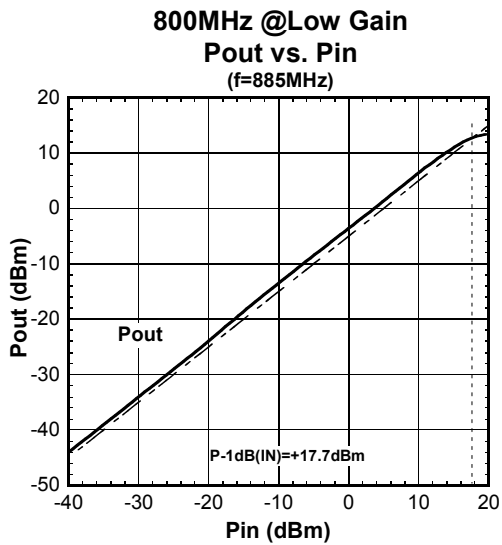

Condition  
 $T_a = +25^\circ\text{C}$ ,  
 $V_{DD} = 2.7\text{V}$ ,  
 $V_{CTL1} = 1.8\text{V}$ ,  $V_{CTL2} = 0\text{V}$ ,  $V_{CTL3} = 0\text{V}$

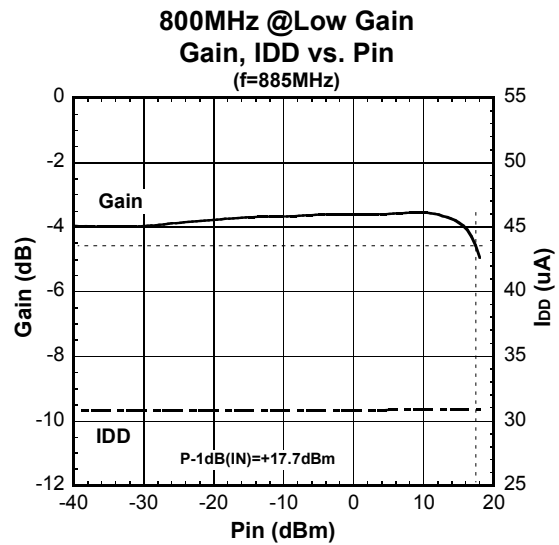

Condition  
 $T_a = +25^\circ\text{C}$ ,  
 $V_{DD} = 2.7\text{V}$ ,  
 $V_{CTL1} = 1.8\text{V}$ ,  $V_{CTL2} = 0\text{V}$ ,  $V_{CTL3} = 0\text{V}$

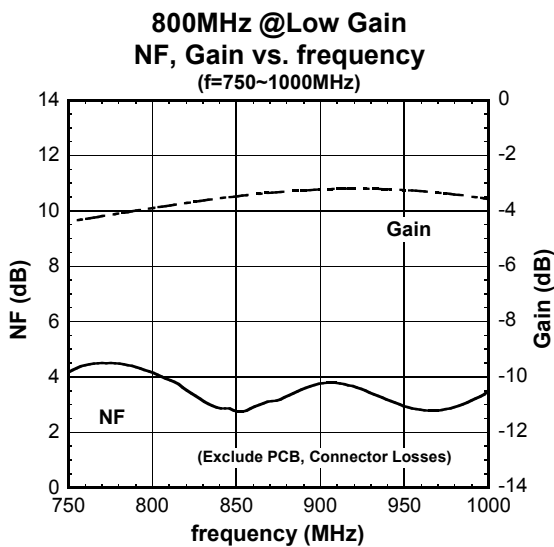

Condition  
 $T_a = +25^\circ\text{C}$ ,  
 $V_{DD} = 2.7\text{V}$ ,  
 $V_{CTL1} = 1.8\text{V}$ ,  $V_{CTL2} = 0\text{V}$ ,  $V_{CTL3} = 0\text{V}$

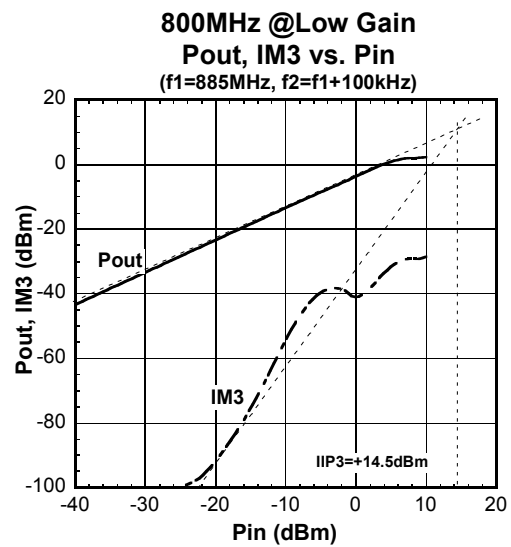

Condition  
 $T_a = +25^\circ\text{C}$ ,  
 $V_{DD} = 2.7\text{V}$ ,  
 $V_{CTL1} = 1.8\text{V}$ ,  $V_{CTL2} = 0\text{V}$ ,  $V_{CTL3} = 0\text{V}$



## ■ELECTRICAL CHARACTERISTICS (800MHz band Low Gain mode)

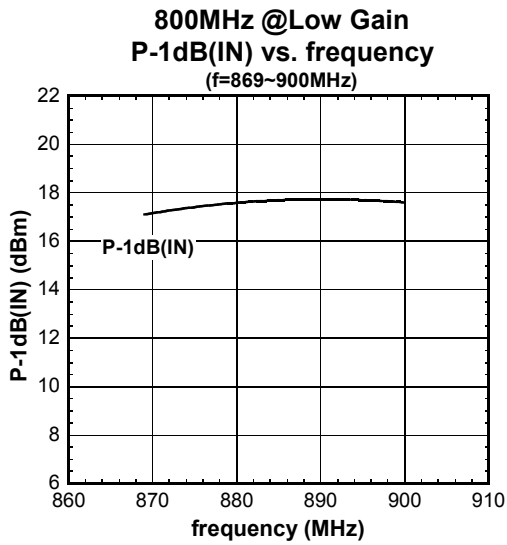

Condition  
 Ta=+25°C,  
 V<sub>DD</sub>= 2.7V,  
 V<sub>CTL1</sub>=1.8V, V<sub>CTL2</sub>=0V, V<sub>CTL3</sub>=0V

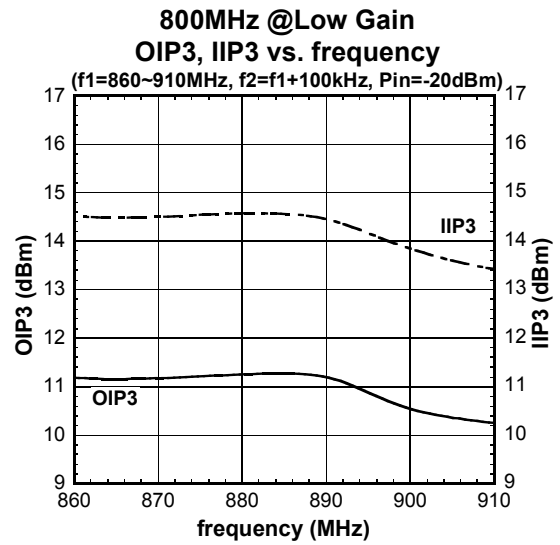

Condition  
 Ta=+25°C,  
 V<sub>DD</sub>= 2.7V,  
 V<sub>CTL1</sub>=1.8V, V<sub>CTL2</sub>=0V, V<sub>CTL3</sub>=0V

# NJG1133MD7

## ■ ELECTRICAL CHARACTERISTICS (800MHz band Low Gain mode)

800MHz @Low Gain  
Gain, NF vs. V<sub>DD</sub>

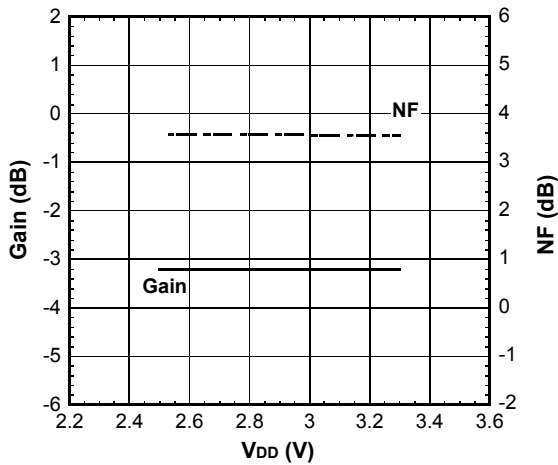

Condition

T<sub>a</sub>=+25°C,  
f=885MHz,  
V<sub>CTL1</sub>=1.8V, V<sub>CTL2</sub>=0V, V<sub>CTL3</sub>=0V

800MHz @Low Gain  
OIP3, IIP3 vs. V<sub>DD</sub>

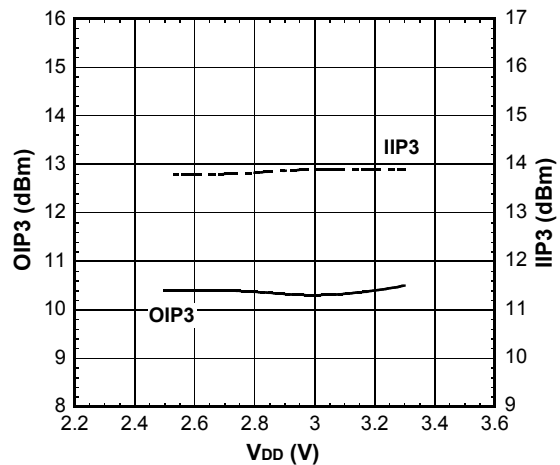

Condition

T<sub>a</sub>=+25°C,  
f<sub>1</sub>=885MHz, f<sub>2</sub>=f<sub>1</sub>+100kHz,  
Pin=-20dBm,  
V<sub>CTL1</sub>=1.8V, V<sub>CTL2</sub>=0V, V<sub>CTL3</sub>=0V

800MHz @Low Gain  
P-1dB(IN) vs. V<sub>DD</sub>

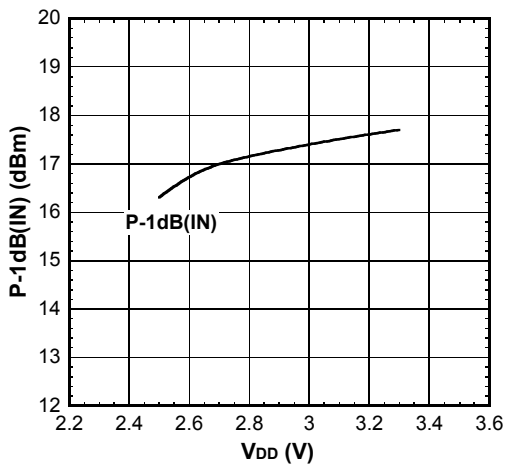

Condition

T<sub>a</sub>=+25°C,  
f=885MHz,  
V<sub>CTL1</sub>=1.8V, V<sub>CTL2</sub>=0V, V<sub>CTL3</sub>=0V

800MHz @Low Gain  
VSWR vs. V<sub>DD</sub>

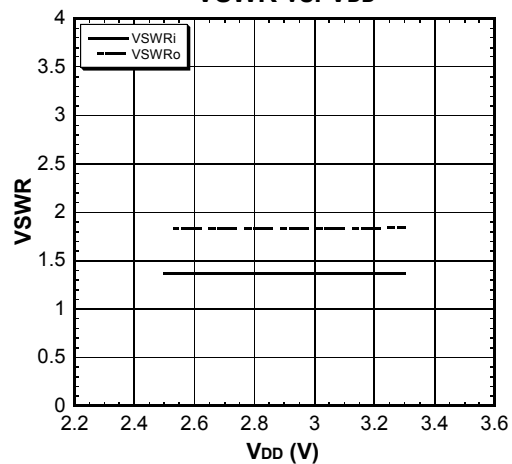

Condition

T<sub>a</sub>=+25°C,  
f=885MHz,  
V<sub>CTL1</sub>=1.8V, V<sub>CTL2</sub>=0V, V<sub>CTL3</sub>=0V

## ■ELECTRICAL CHARACTERISTICS (800MHz band Low Gain mode)

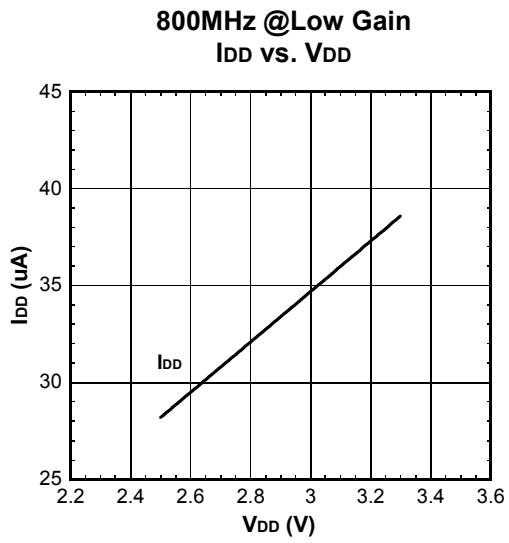

Condition

T<sub>a</sub>=+25°C,

R<sub>F</sub>=OFF

V<sub>CTL1</sub>=1.8V, V<sub>CTL2</sub>=0V, V<sub>CTL3</sub>=0V

# NJG1133MD7

## ■ ELECTRICAL CHARACTERISTICS (800MHz band Low Gain mode)

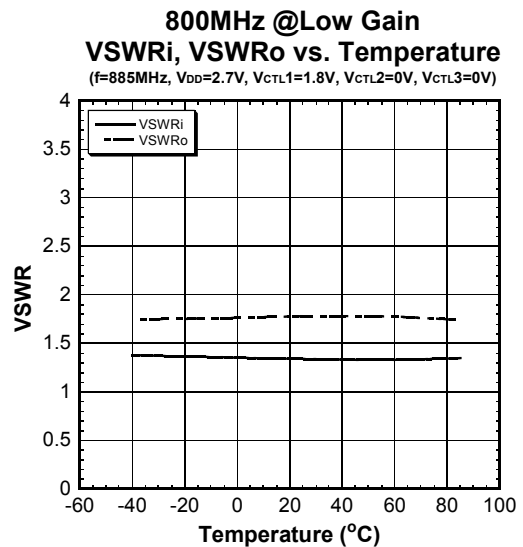
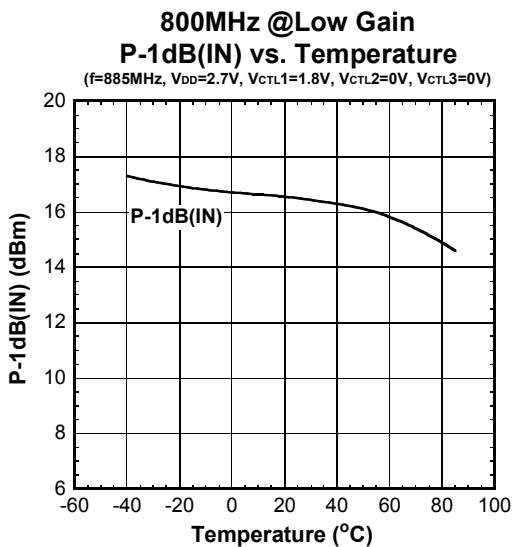
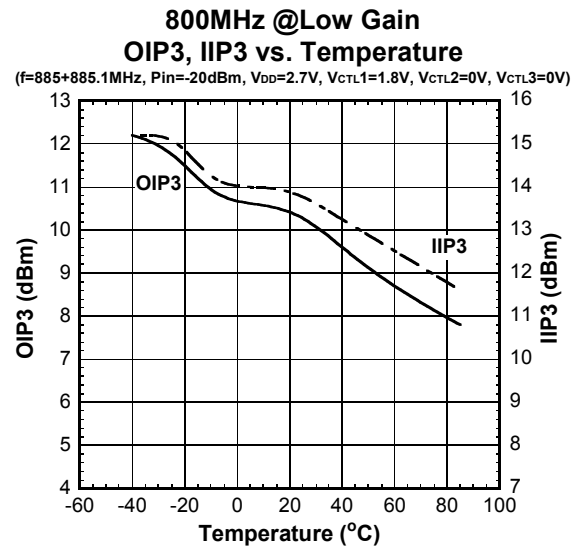
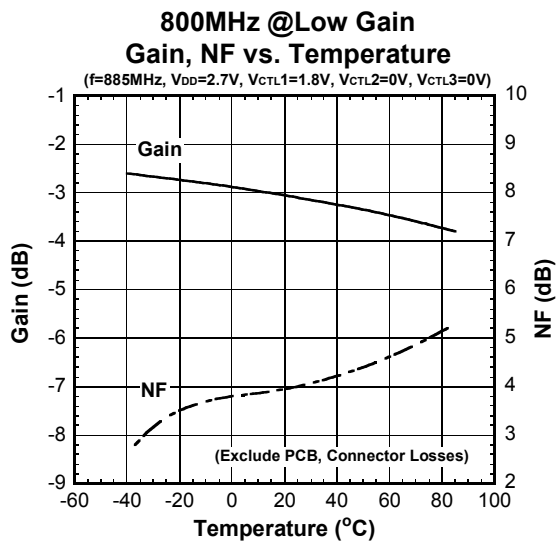

## ■ ELECTRICAL CHARACTERISTICS (800MHz band Low Gain mode)

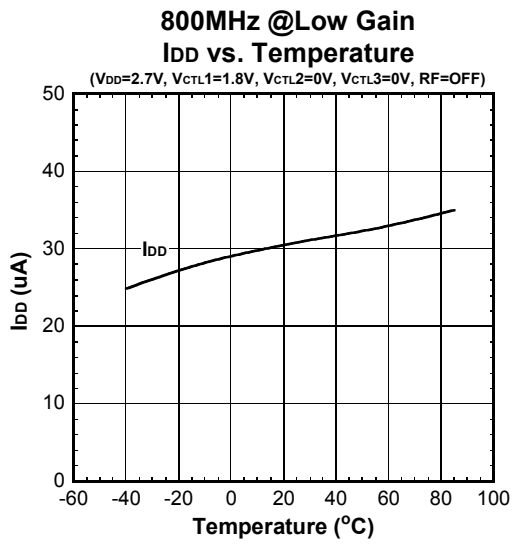

# NJG1133MD7

## ELECTRICAL CHARACTERISTICS (800MHz band Low Gain mode)

Condition : Ta=+25°C, V<sub>DD</sub>= 2.7V, V<sub>CTL1</sub>=1.8V, V<sub>CTL2</sub>=0V, V<sub>CTL3</sub>=0V

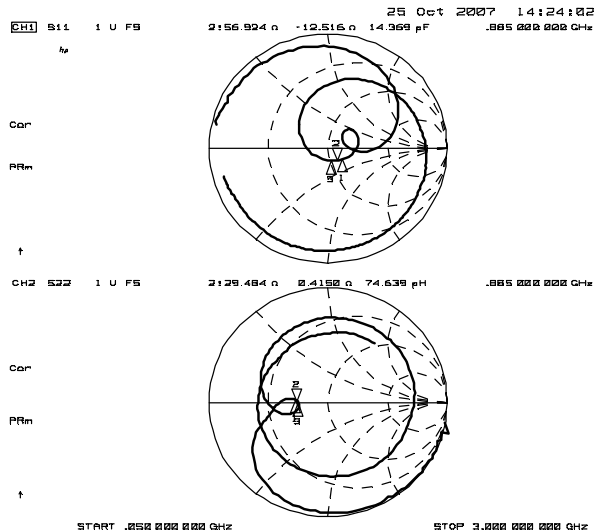
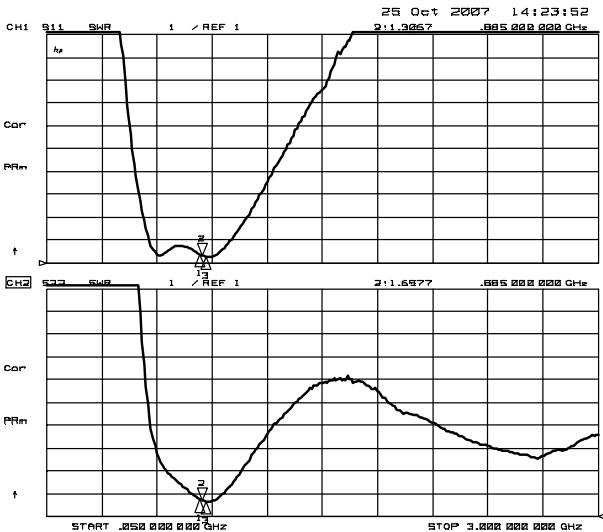
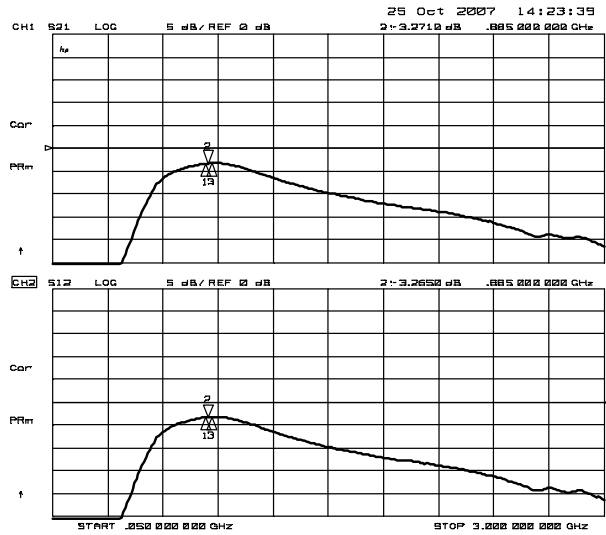
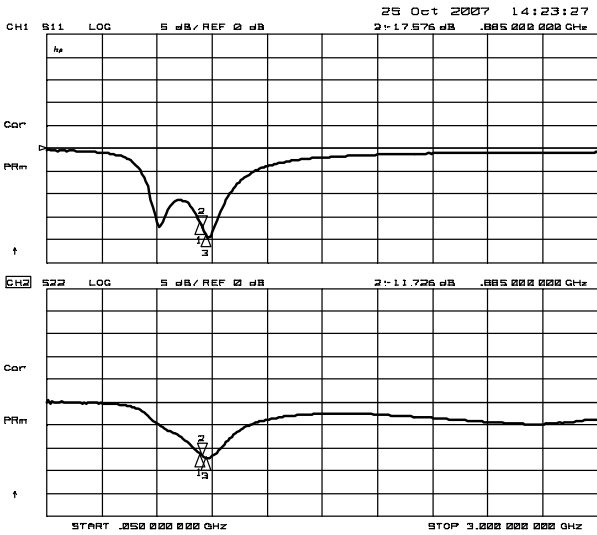

## ■ELECTRICAL CHARACTERISTICS (800MHz band Low Gain mode)

Condition :  $T_a=+25^{\circ}\text{C}$ ,  $V_{DD}= 2.7\text{V}$ ,  $V_{CTL1}=1.8\text{V}$ ,  $V_{CTL2}=0\text{V}$ ,  $V_{CTL3}=0\text{V}$

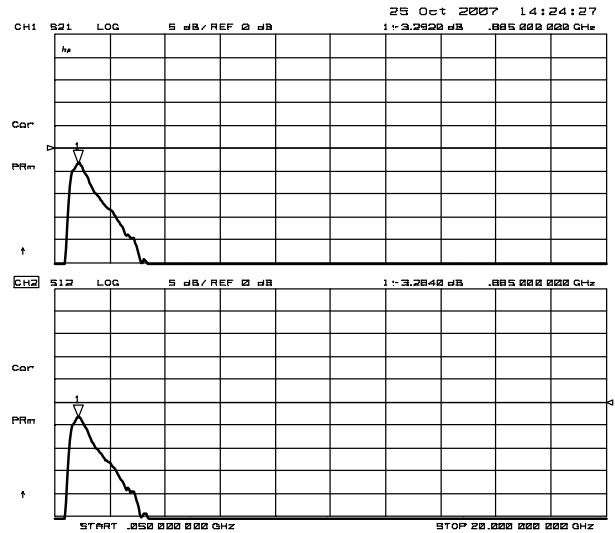
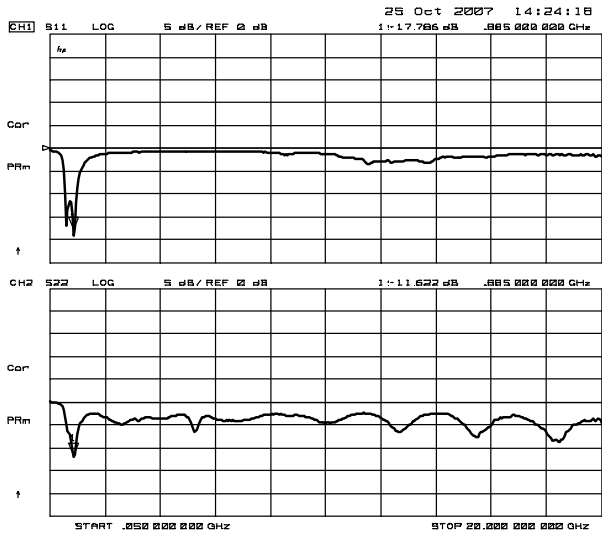

**800MHz @Low Gain  
 k factor vs. frequency  
 (f=50MHz~20GHz)**

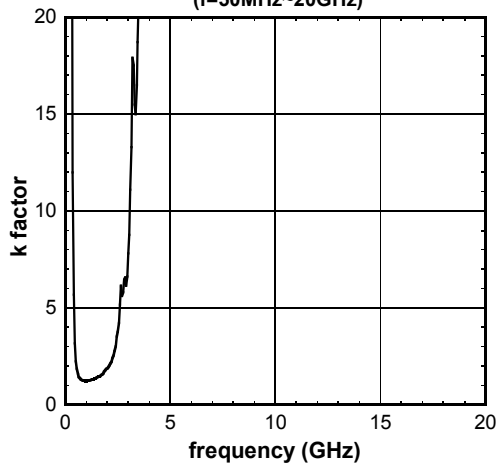

# NJG1133MD7

## ■ ELECTRICAL CHARACTERISTICS (1.7GHz band High Gain mode)

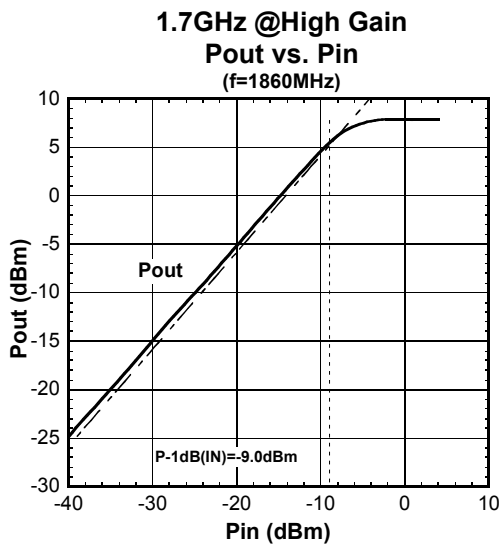

Condition  
 $T_a = +25^\circ\text{C}$ ,  
 $V_{DD} = 2.7\text{V}$ ,  
 $V_{CTL1} = 0\text{V}$ ,  $V_{CTL2} = 1.8\text{V}$ ,  $V_{CTL3} = 1.8\text{V}$

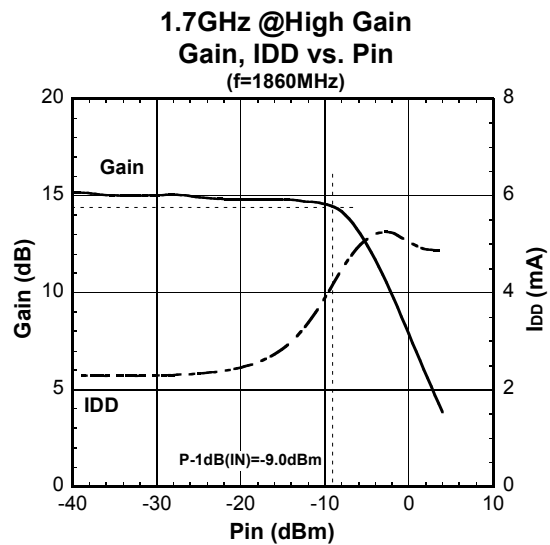

Condition  
 $T_a = +25^\circ\text{C}$ ,  
 $V_{DD} = 2.7\text{V}$ ,  
 $V_{CTL1} = 0\text{V}$ ,  $V_{CTL2} = 1.8\text{V}$ ,  $V_{CTL3} = 1.8\text{V}$

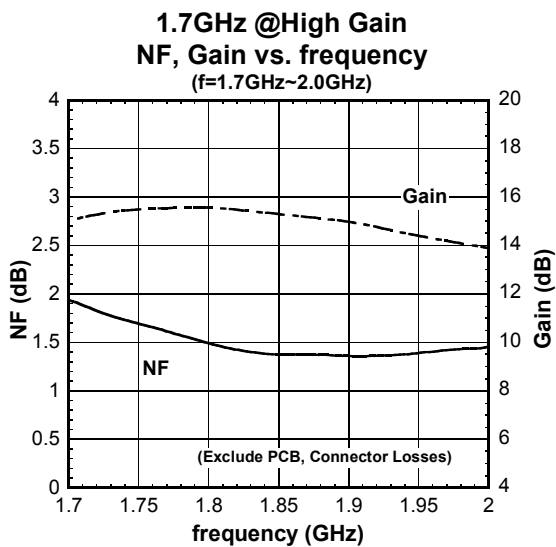

Condition  
 $T_a = +25^\circ\text{C}$ ,  
 $V_{DD} = 2.7\text{V}$ ,  
 $V_{CTL1} = 0\text{V}$ ,  $V_{CTL2} = 1.8\text{V}$ ,  $V_{CTL3} = 1.8\text{V}$

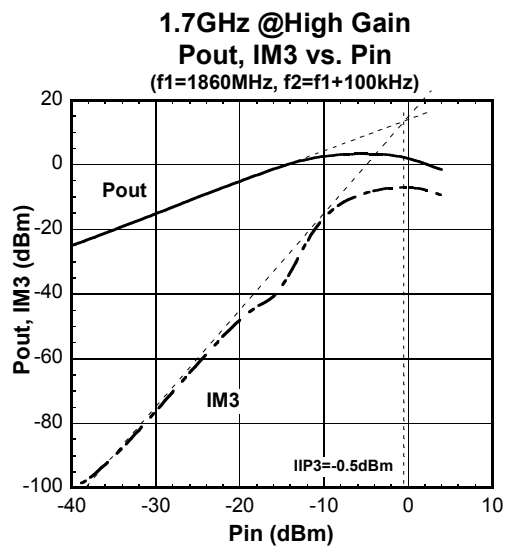

Condition  
 $T_a = +25^\circ\text{C}$ ,  
 $V_{DD} = 2.7\text{V}$ ,  
 $V_{CTL1} = 0\text{V}$ ,  $V_{CTL2} = 1.8\text{V}$ ,  $V_{CTL3} = 1.8\text{V}$



## ■ELECTRICAL CHARACTERISTICS (1.7GHz band High Gain mode)

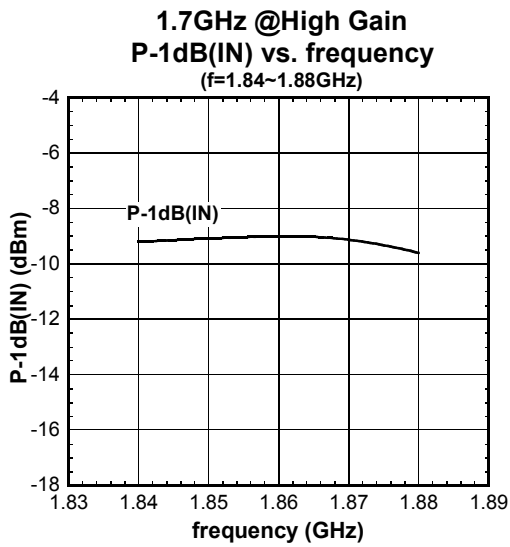

Condition  
 Ta=+25°C,  
 V<sub>DD</sub>= 2.7V,  
 V<sub>CTL1</sub>=0V, V<sub>CTL2</sub>=1.8V, V<sub>CTL3</sub>=1.8V

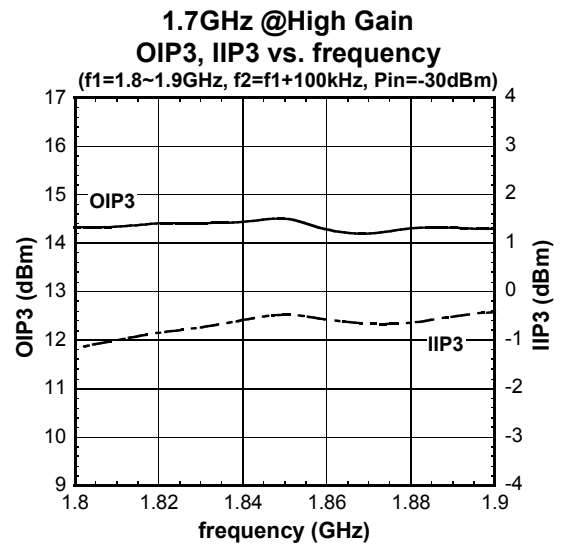

Condition  
 Ta=+25°C,  
 V<sub>DD</sub>= 2.7V,  
 V<sub>CTL1</sub>=0V, V<sub>CTL2</sub>=1.8V, V<sub>CTL3</sub>=1.8V

# NJG1133MD7

## ELECTRICAL CHARACTERISTICS (1.7GHz band High Gain mode)

1.7GHz @High Gain  
Gain, NF vs. V<sub>DD</sub>

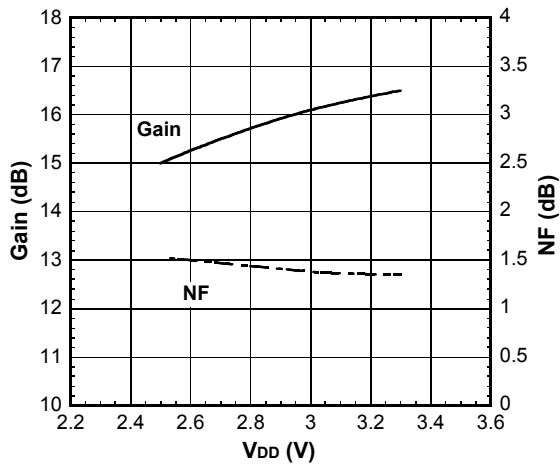

Condition

T<sub>a</sub>=+25°C,  
f=1860MHz,  
V<sub>CTL1</sub>=0V, V<sub>CTL2</sub>=1.8V, V<sub>CTL3</sub>=1.8V

1.7GHz @High Gain  
OIP3, IIP3 vs. V<sub>DD</sub>

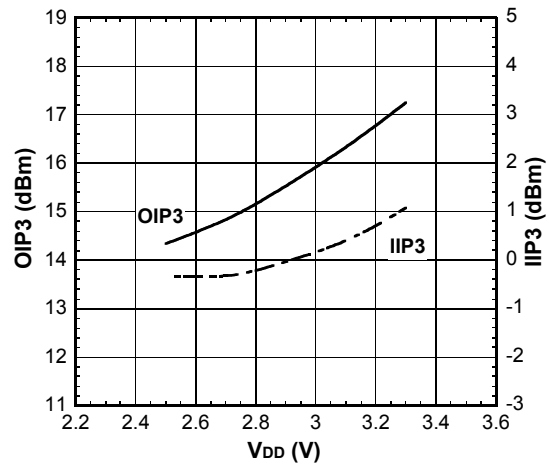

Condition

T<sub>a</sub>=+25°C,  
f<sub>1</sub>=1860MHz, f<sub>2</sub>=f<sub>1</sub>+100kHz,  
Pin=-30dBm,  
V<sub>CTL1</sub>=0V, V<sub>CTL2</sub>=1.8V, V<sub>CTL3</sub>=1.8V

1.7GHz @High Gain  
P-1dB(IN) vs. V<sub>DD</sub>

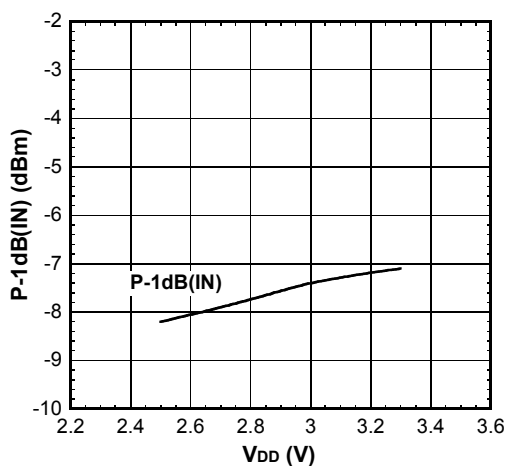

Condition

T<sub>a</sub>=+25°C,  
f=1860MHz,  
V<sub>CTL1</sub>=0V, V<sub>CTL2</sub>=1.8V, V<sub>CTL3</sub>=1.8V

1.7GHz @High Gain  
VSWR vs. V<sub>DD</sub>

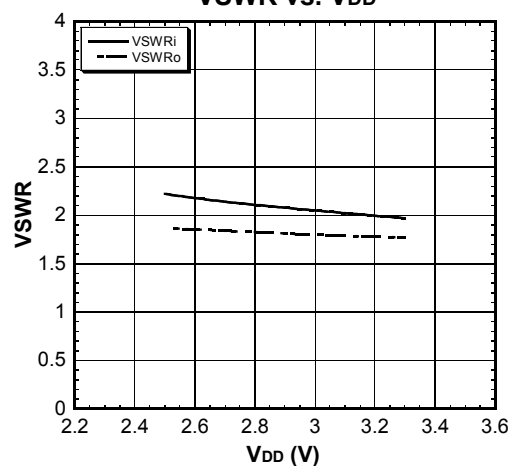

Condition

T<sub>a</sub>=+25°C,  
f=1860MHz,  
V<sub>CTL1</sub>=0V, V<sub>CTL2</sub>=1.8V, V<sub>CTL3</sub>=1.8V

## ■ELECTRICAL CHARACTERISTICS (1.7GHz band High Gain mode)

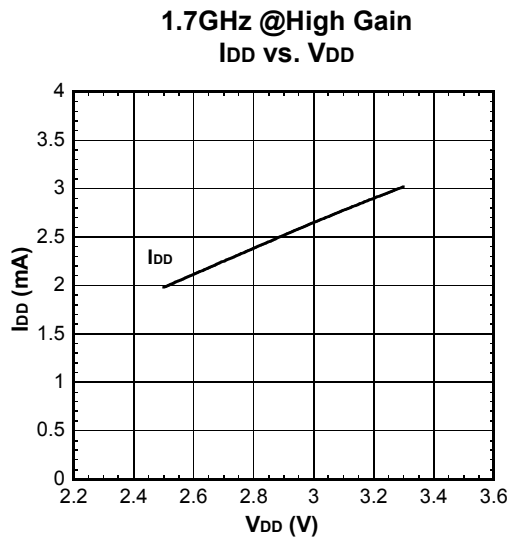

Condition

T<sub>a</sub>=+25°C,

RF=OFF

V<sub>CTL1</sub>=0V, V<sub>CTL2</sub>=1.8V, V<sub>CTL3</sub>=1.8V

# NJG1133MD7

## ■ ELECTRICAL CHARACTERISTICS (1.7GHz band High Gain mode)

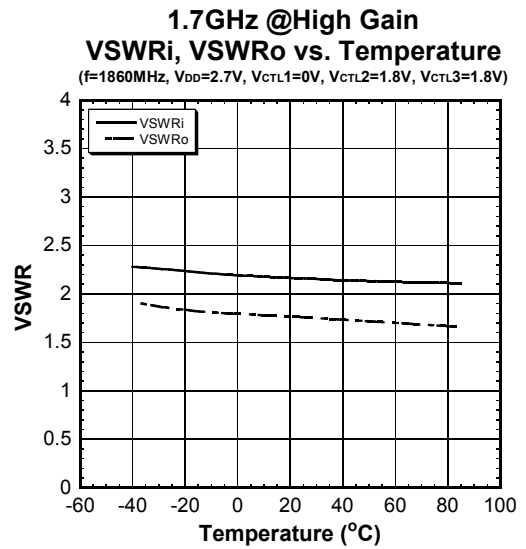
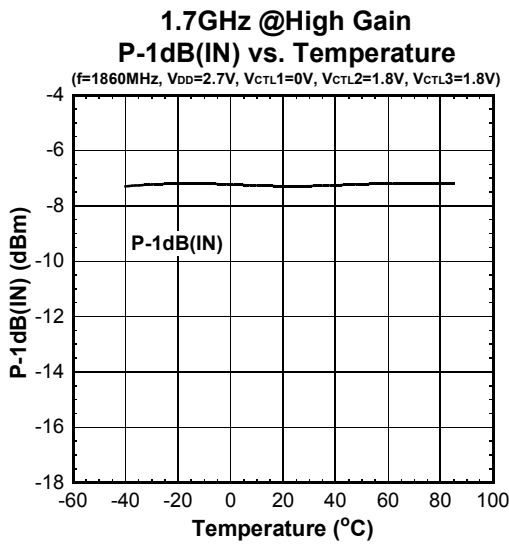
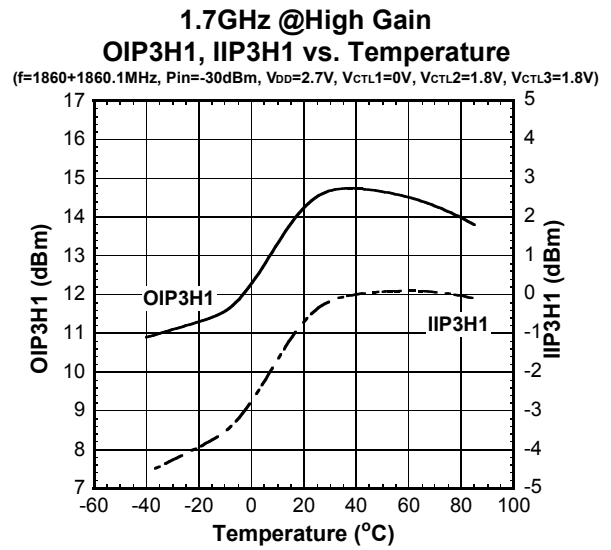
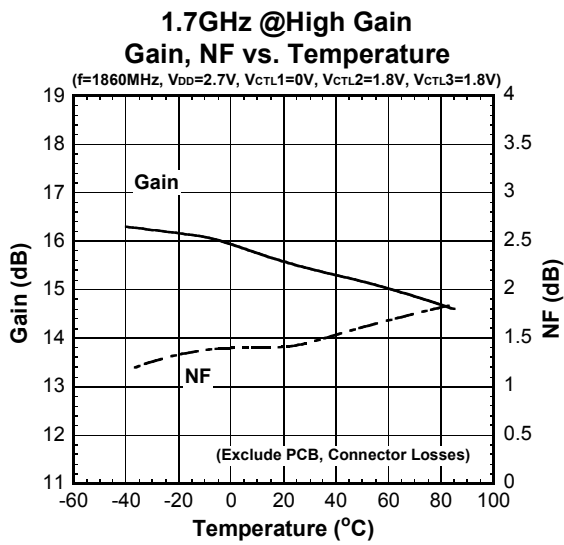

## ■ ELECTRICAL CHARACTERISTICS (1.7GHz band High Gain mode)

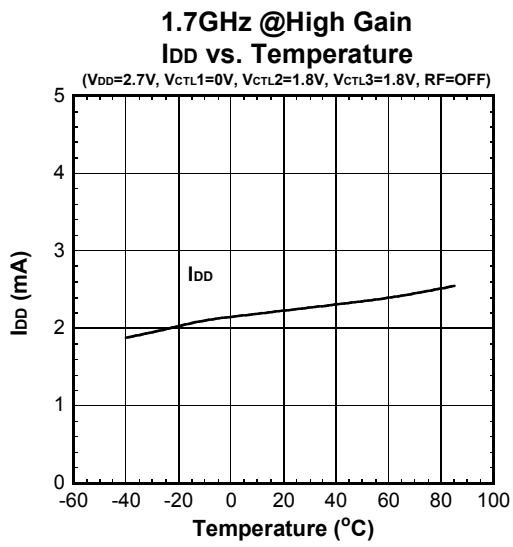

# NJG1133MD7

## ELECTRICAL CHARACTERISTICS (1.7GHz band High Gain mode)

Condition : Ta=+25°C, V<sub>DD</sub>= 2.7V, V<sub>CTL1</sub>=0V, V<sub>CTL2</sub>=1.8V, V<sub>CTL3</sub>=1.8V

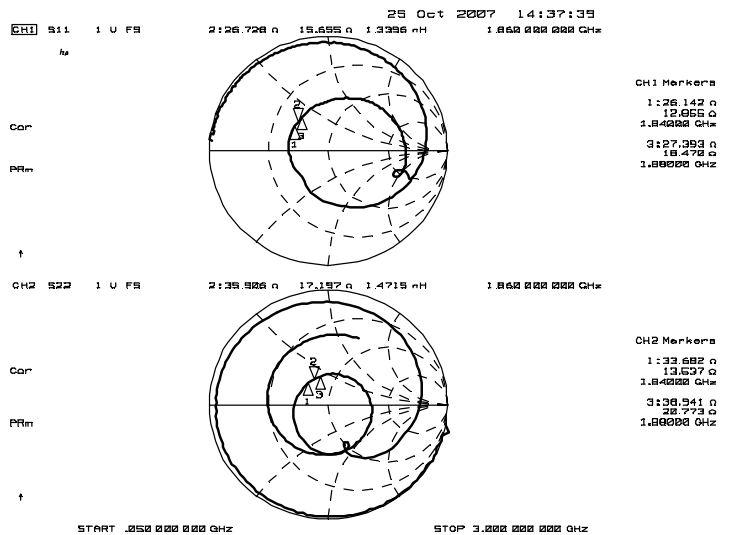
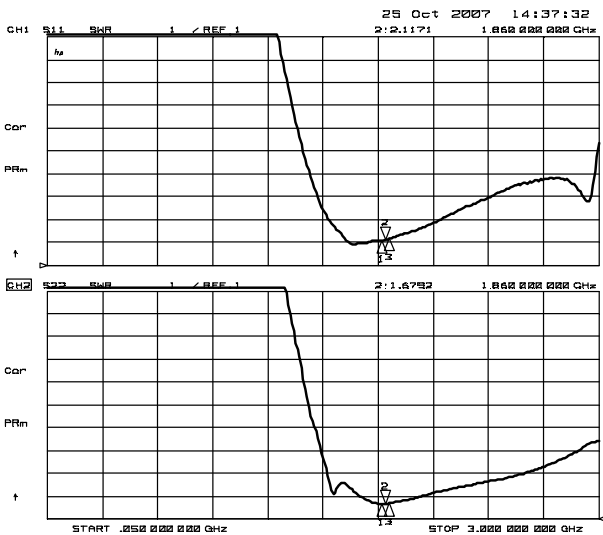
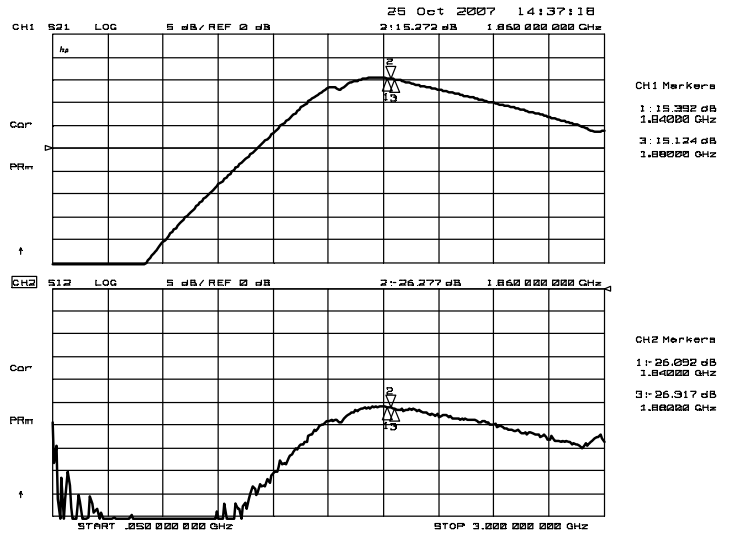
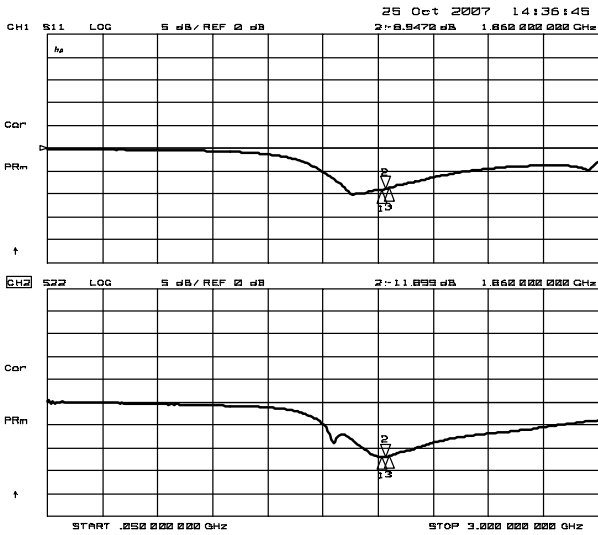

## ■ELECTRICAL CHARACTERISTICS (1.7GHz band High Gain mode)

Condition : Ta=+25°C, V<sub>DD</sub>= 2.7V, V<sub>CTL1</sub>=0V, V<sub>CTL2</sub>=1.8V, V<sub>CTL3</sub>=1.8V

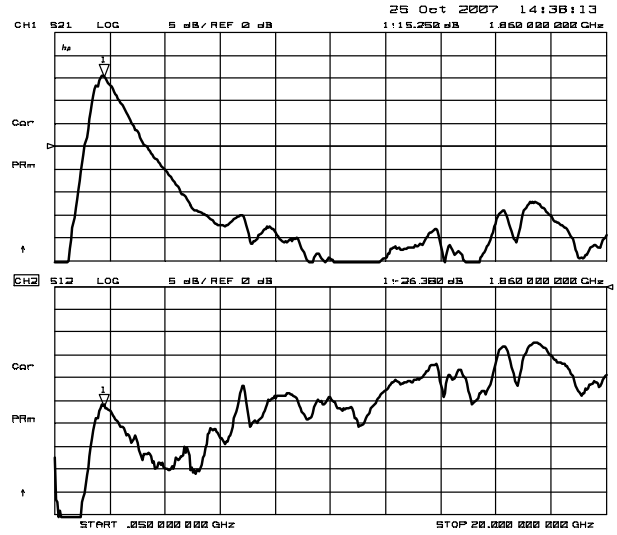
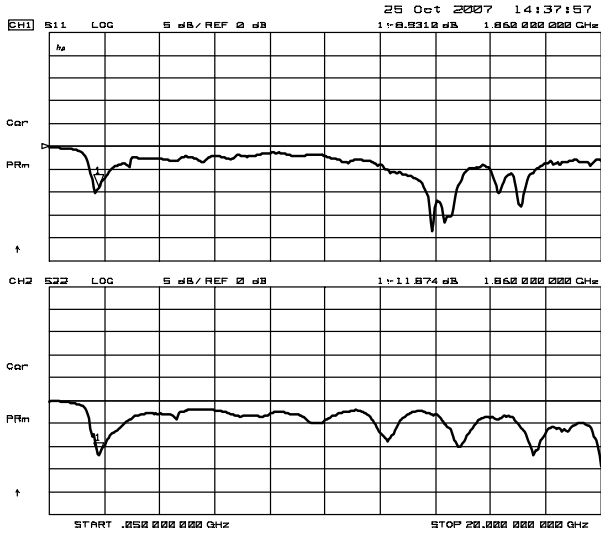

**1.7GHz @High Gain  
 k factor vs. frequency  
 (f=50MHz~20GHz)**

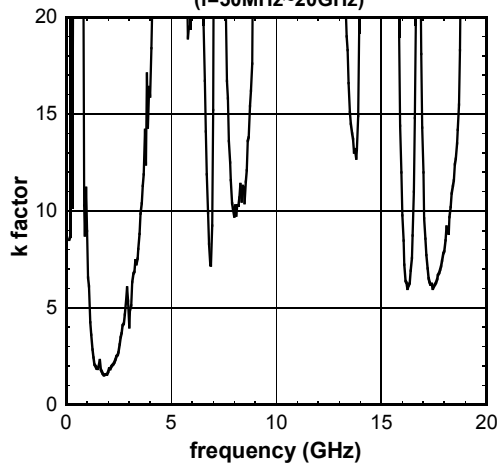

# NJG1133MD7

## ■ ELECTRICAL CHARACTERISTICS (1.7GHz band Low Gain mode)

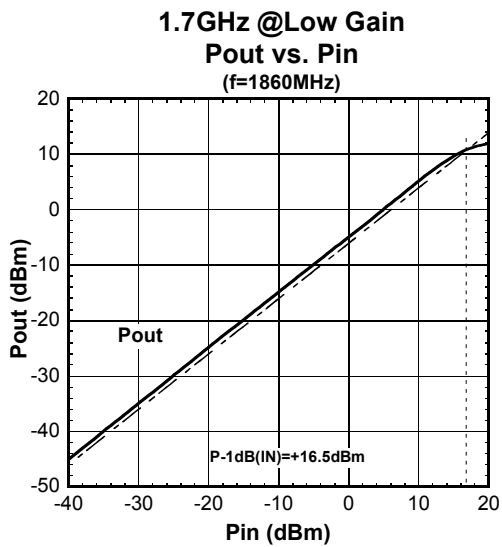

Condition  
 $T_a = +25^\circ\text{C}$ ,  
 $V_{DD} = 2.7\text{V}$ ,  
 $V_{CTL1} = 0\text{V}$ ,  $V_{CTL2} = 1.8\text{V}$ ,  $V_{CTL3} = 0\text{V}$

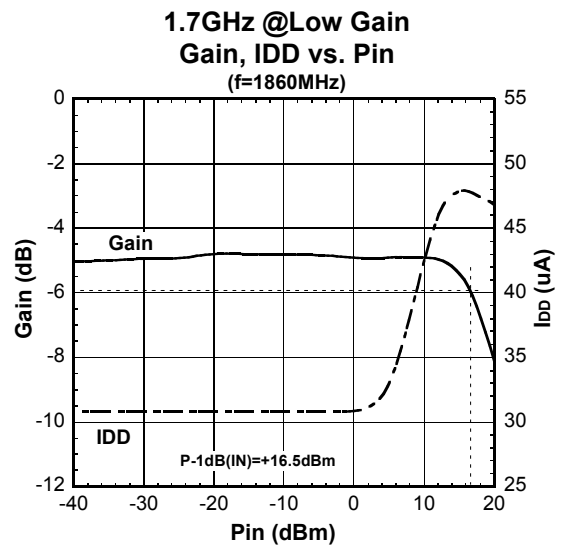

Condition  
 $T_a = +25^\circ\text{C}$ ,  
 $V_{DD} = 2.7\text{V}$ ,  
 $V_{CTL1} = 0\text{V}$ ,  $V_{CTL2} = 1.8\text{V}$ ,  $V_{CTL3} = 0\text{V}$

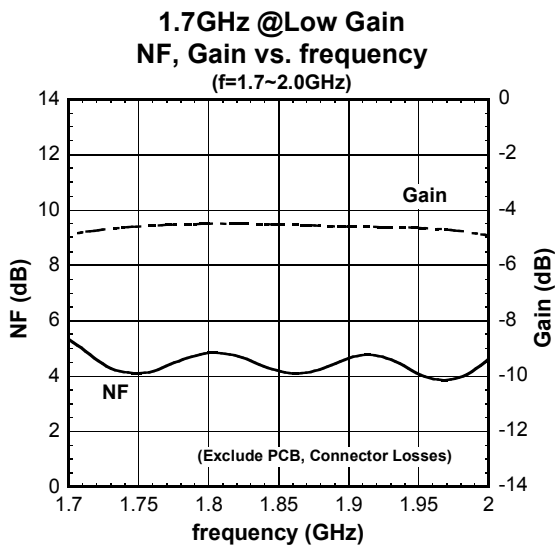

Condition  
 $T_a = +25^\circ\text{C}$ ,  
 $V_{DD} = 2.7\text{V}$ ,  
 $V_{CTL1} = 0\text{V}$ ,  $V_{CTL2} = 1.8\text{V}$ ,  $V_{CTL3} = 0\text{V}$

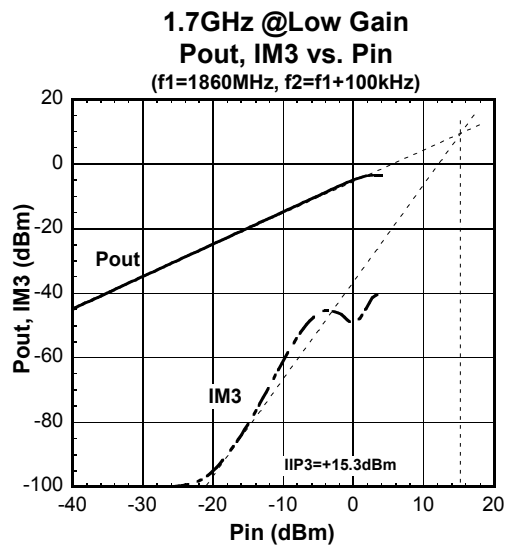

Condition  
 $T_a = +25^\circ\text{C}$ ,  
 $V_{DD} = 2.7\text{V}$ ,  
 $V_{CTL1} = 0\text{V}$ ,  $V_{CTL2} = 1.8\text{V}$ ,  $V_{CTL3} = 0\text{V}$



## ■ELECTRICAL CHARACTERISTICS (1.7GHz band Low Gain mode)

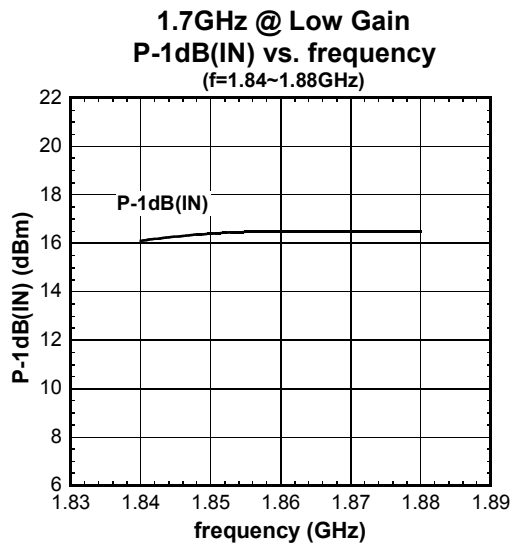

Condition

Ta=+25°C,

V<sub>DD</sub>= 2.7V,

V<sub>CTL1</sub>=0V, V<sub>CTL2</sub>=1.8V, V<sub>CTL3</sub>=0V

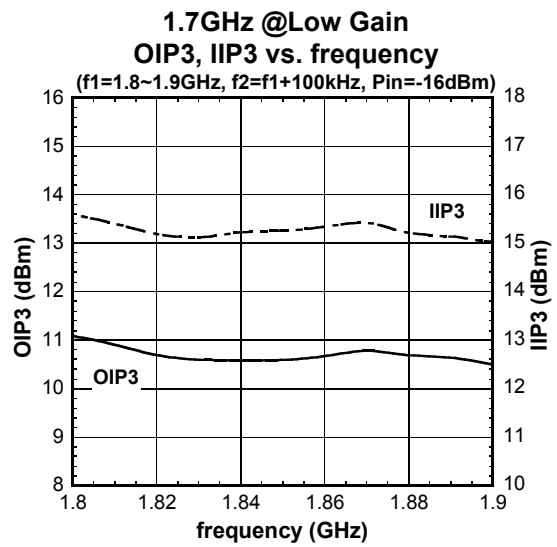

Condition

Ta=+25°C,

V<sub>DD</sub>= 2.7V,

V<sub>CTL1</sub>=0V, V<sub>CTL2</sub>=1.8V, V<sub>CTL3</sub>=0V

# NJG1133MD7

## ■ELECTRICAL CHARACTERISTICS (1.7GHz band Low Gain mode)

1.7GHz @Low Gain  
Gain, NF vs. V<sub>DD</sub>

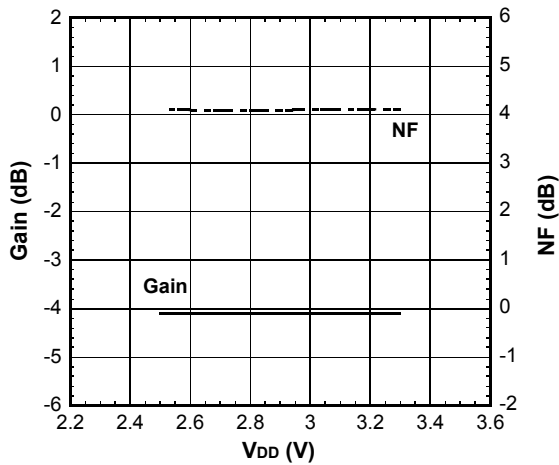

Condition  
 Ta=+25°C,  
 f=1860MHz,  
 V<sub>CTL1</sub>=0V, V<sub>CTL2</sub>=1.8V, V<sub>CTL3</sub>=0V

1.7GHz @Low Gain  
OIP3, IIP3 vs. V<sub>DD</sub>

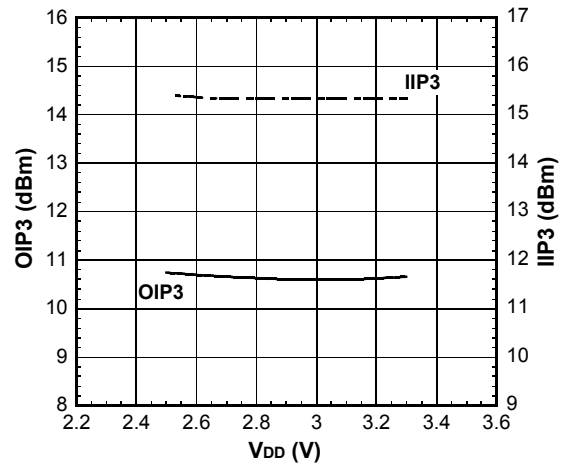

Condition  
 Ta=+25°C,  
 f1=1860MHz, f2=f1+100kHz,  
 Pin=-16dBm,  
 V<sub>CTL1</sub>=0V, V<sub>CTL2</sub>=1.8V, V<sub>CTL3</sub>=0V

1.7GHz @Low Gain  
P-1dB(IN) vs. V<sub>DD</sub>

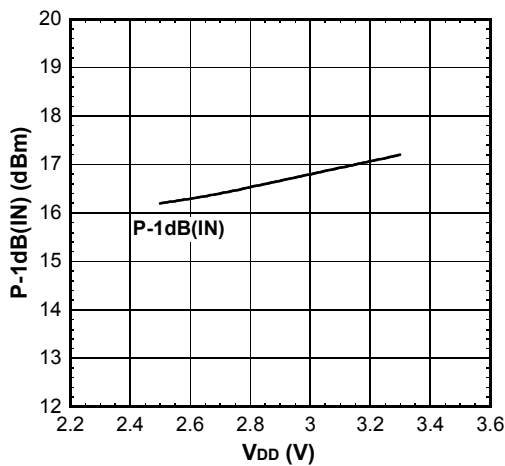

Condition  
 Ta=+25°C,  
 f=1860MHz,  
 V<sub>CTL1</sub>=0V, V<sub>CTL2</sub>=1.8V, V<sub>CTL3</sub>=0V

1.7GHz @Low Gain  
VSWR vs. V<sub>DD</sub>

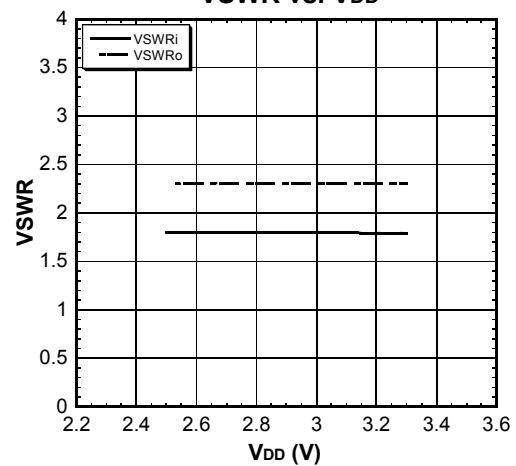

Condition  
 Ta=+25°C,  
 f=1860MHz,  
 V<sub>CTL1</sub>=0V, V<sub>CTL2</sub>=1.8V, V<sub>CTL3</sub>=0V

## ■ ELECTRICAL CHARACTERISTICS (1.7GHz band Low Gain mode)

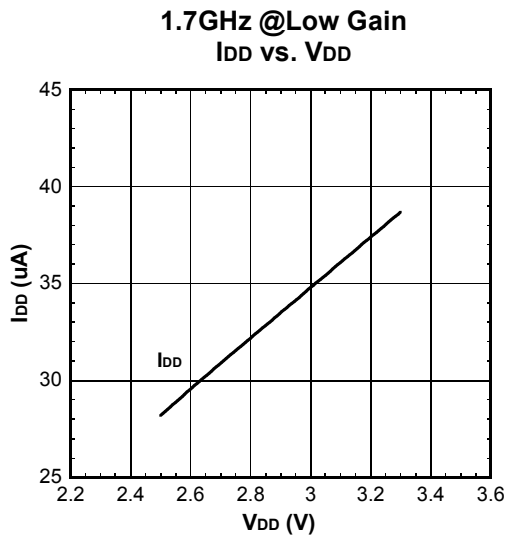

Condition

T<sub>a</sub>=+25°C,

RF=OFF,

V<sub>CTL1</sub>=0V, V<sub>CTL2</sub>=1.8V, V<sub>CTL3</sub>=0V

# NJG1133MD7

## ■ ELECTRICAL CHARACTERISTICS (1.7GHz band Low Gain mode)

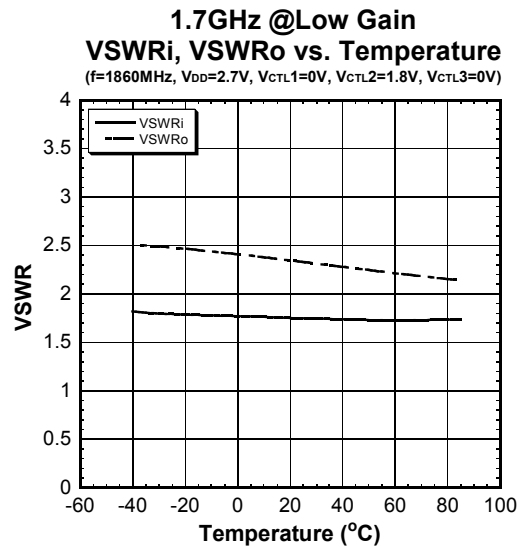
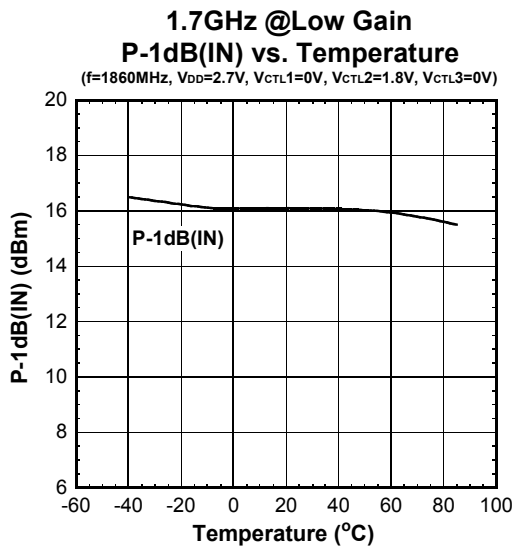
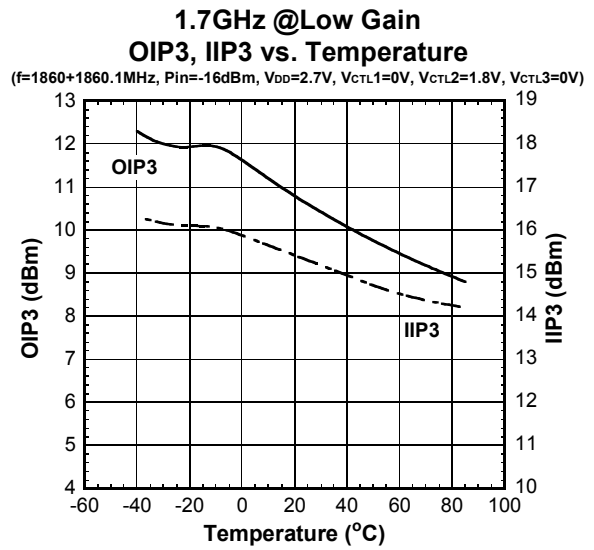
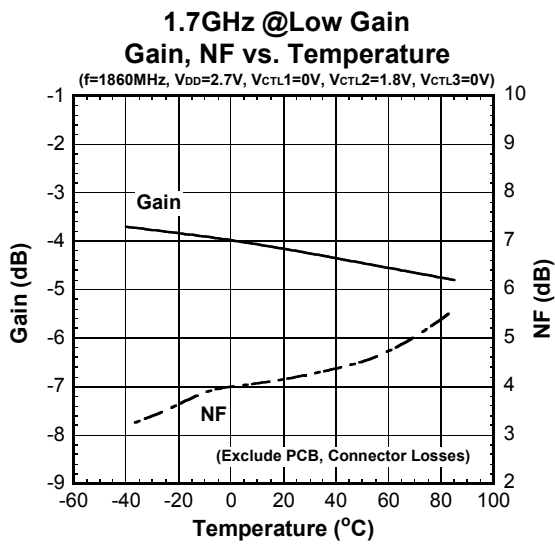

## ■ ELECTRICAL CHARACTERISTICS (1.7GHz band Low Gain mode)

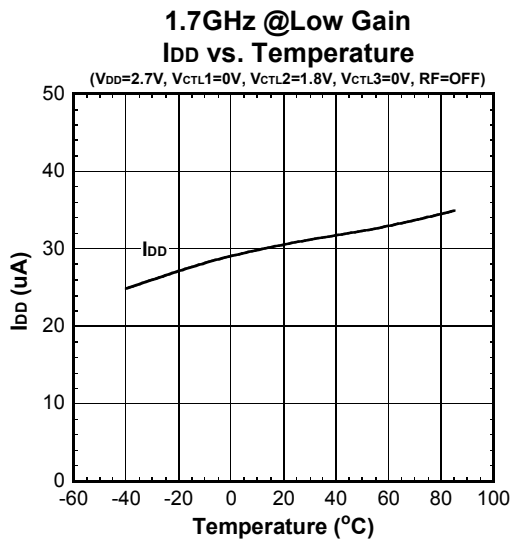

# NJG1133MD7

## ELECTRICAL CHARACTERISTICS (1.7GHz band Low Gain mode)

Condition : Ta=+25°C, V<sub>DD</sub>= 2.7V, V<sub>CTL1</sub>=0V, V<sub>CTL2</sub>=1.8V, V<sub>CTL3</sub>=0V

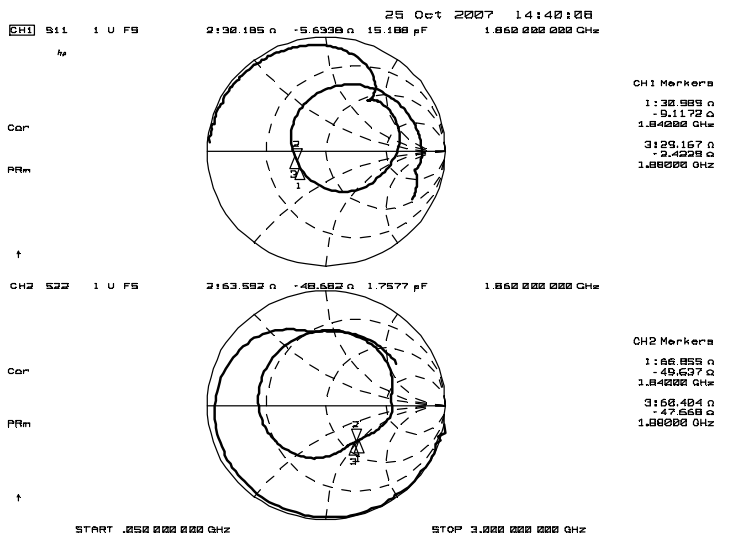
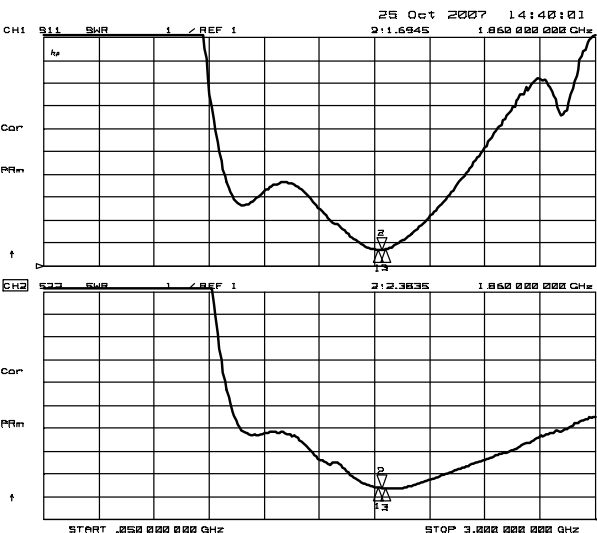
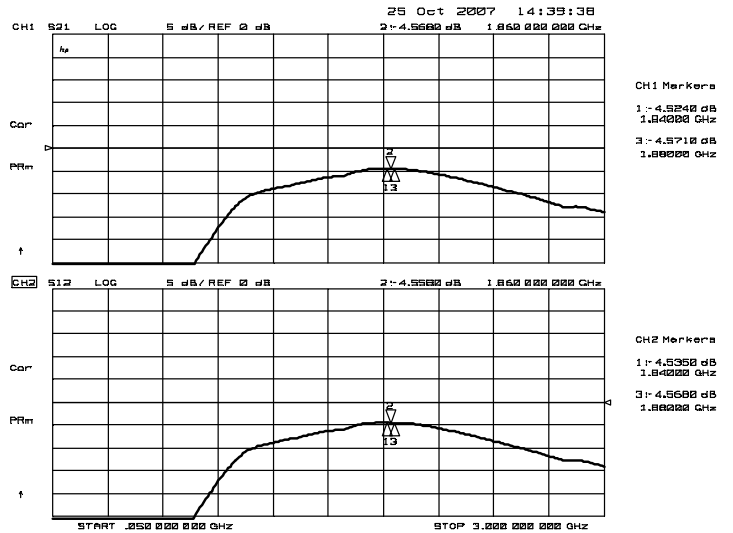
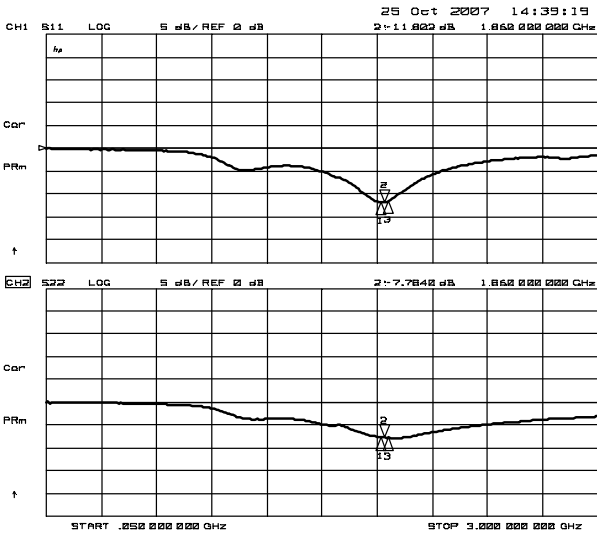

## ■ELECTRICAL CHARACTERISTICS (1.7GHz band Low Gain mode)

Condition :  $T_a = +25^\circ\text{C}$ ,  $V_{DD} = V_{INV} = 2.7\text{V}$ ,  $V_{CTL1} = 0\text{V}$ ,  $V_{CTL2} = 1.8\text{V}$ ,  $V_{CTL3} = 0\text{V}$

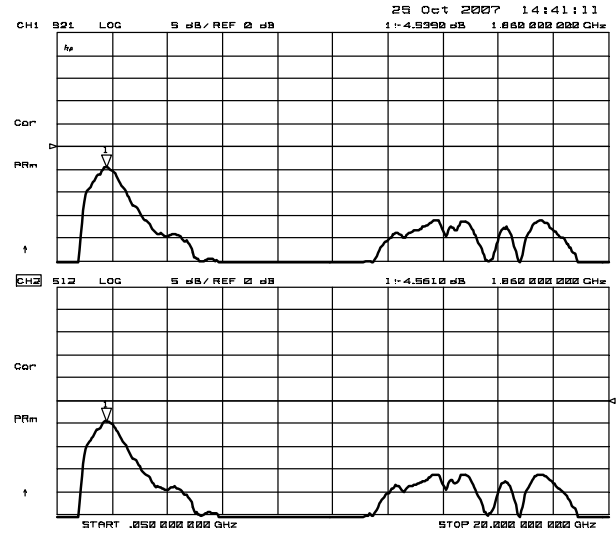
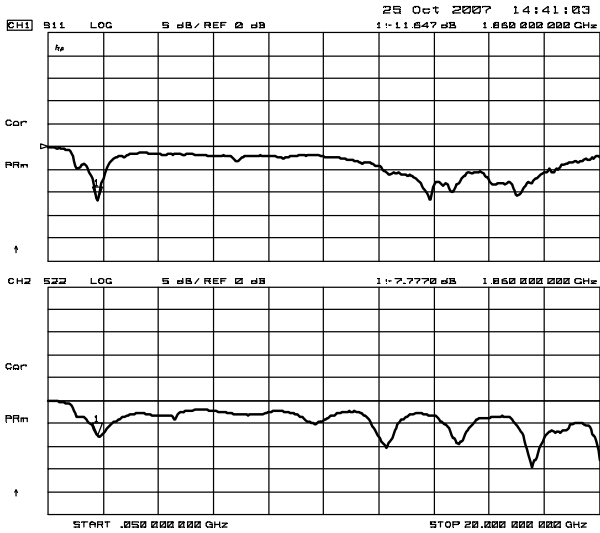

1.7GHz @Low Gain  
 k factor vs. frequency  
 (f=50MHz~20GHz)

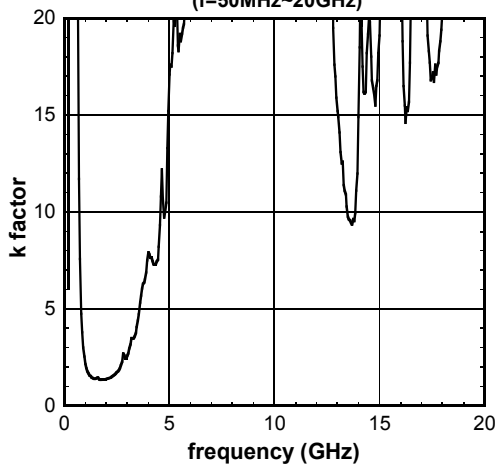

# NJG1133MD7

## ■ ELECTRICAL CHARACTERISTICS (1.5GHz band High Gain mode)

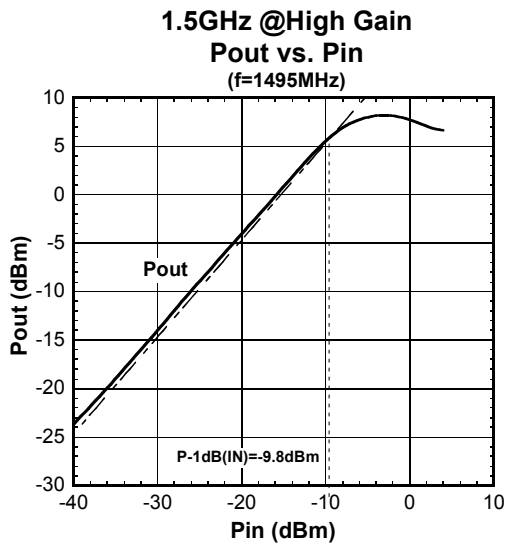

Condition  
 $T_a = +25^\circ\text{C}$ ,  
 $V_{DD} = 2.7\text{V}$ ,  
 $V_{CTL1} = 1.8\text{V}$ ,  $V_{CTL2} = 1.8\text{V}$ ,  $V_{CTL3} = 1.8\text{V}$

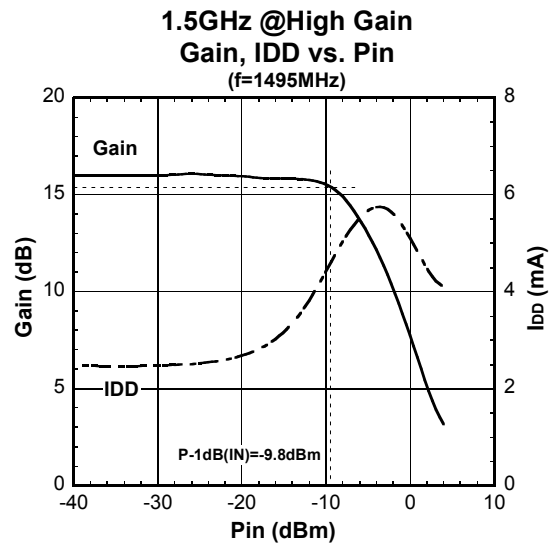

Condition  
 $T_a = +25^\circ\text{C}$ ,  
 $V_{DD} = 2.7\text{V}$ ,  
 $V_{CTL1} = 1.8\text{V}$ ,  $V_{CTL2} = 1.8\text{V}$ ,  $V_{CTL3} = 1.8\text{V}$

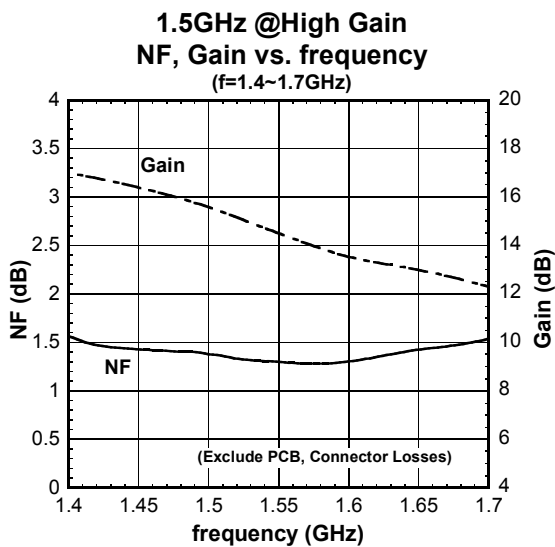

Condition  
 $T_a = +25^\circ\text{C}$ ,  
 $V_{DD} = 2.7\text{V}$ ,  
 $V_{CTL1} = 1.8\text{V}$ ,  $V_{CTL2} = 1.8\text{V}$ ,  $V_{CTL3} = 1.8\text{V}$

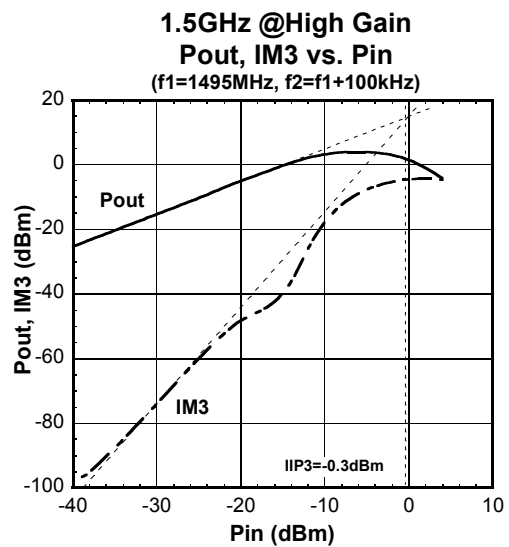

Condition  
 $T_a = +25^\circ\text{C}$ ,  
 $V_{DD} = 2.7\text{V}$ ,  
 $V_{CTL1} = 1.8\text{V}$ ,  $V_{CTL2} = 1.8\text{V}$ ,  $V_{CTL3} = 1.8\text{V}$



## ■ELECTRICAL CHARACTERISTICS (1.5GHz band High Gain mode)

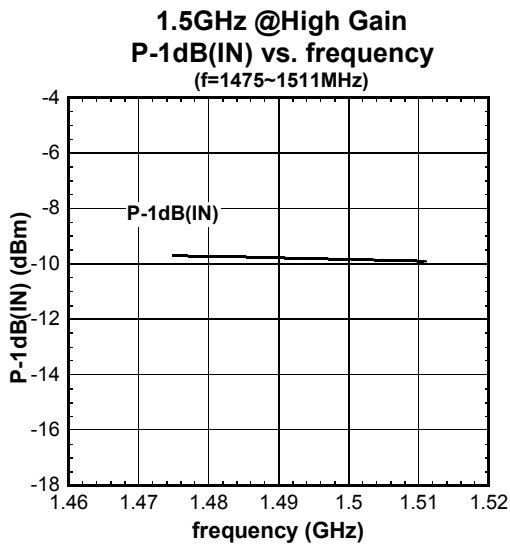

Condition

Ta=+25°C,  
V<sub>DD</sub>= 2.7V,  
V<sub>CTL1</sub>=1.8V, V<sub>CTL2</sub>=1.8V, V<sub>CTL3</sub>=1.8V

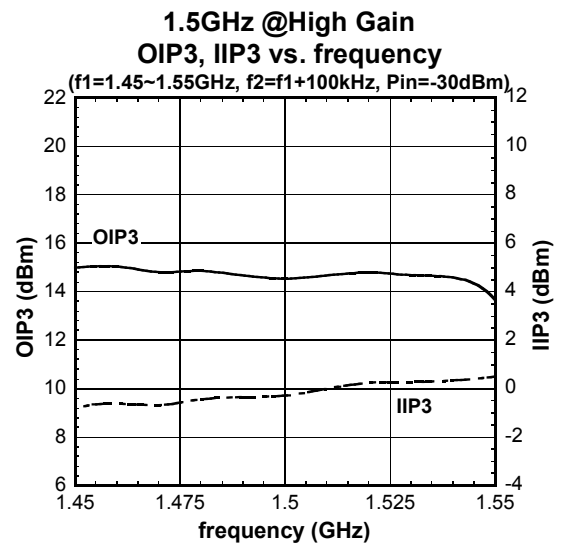

Condition

Ta=+25°C,  
V<sub>DD</sub>= 2.7V,  
V<sub>CTL1</sub>=1.8V, V<sub>CTL2</sub>=1.8V, V<sub>CTL3</sub>=1.8V

# NJG1133MD7

## ■ ELECTRICAL CHARACTERISTICS (1.5GHz band High Gain mode)

1.5GHz @High Gain  
Gain, NF vs. V<sub>DD</sub>

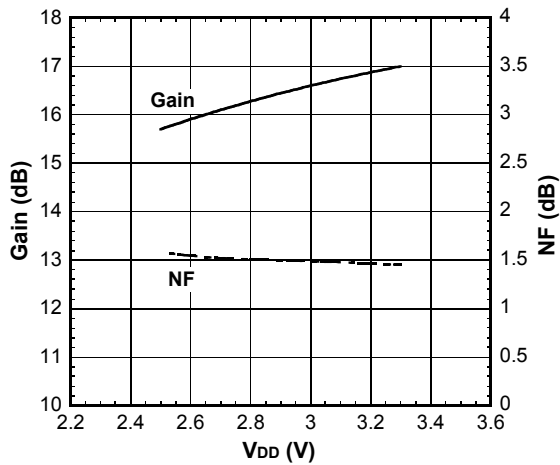

Condition

T<sub>a</sub>=+25°C,  
f=1495MHz,  
V<sub>CTL1</sub>=1.8V, V<sub>CTL2</sub>=1.8V, V<sub>CTL3</sub>=1.8V

1.5GHz @High Gain  
OIP3, IIP3 vs. V<sub>DD</sub>

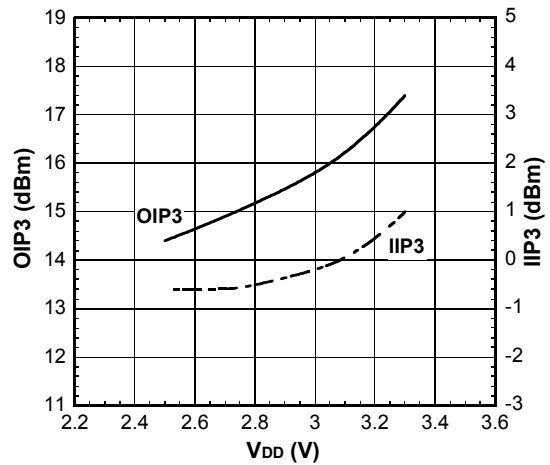

Condition

T<sub>a</sub>=+25°C,  
f<sub>1</sub>=1495MHz, f<sub>2</sub>=f<sub>1</sub>+100kHz,  
P<sub>in</sub>=-30dBm,  
V<sub>CTL1</sub>=1.8V, V<sub>CTL2</sub>=1.8V, V<sub>CTL3</sub>=1.8V

1.5GHz @High Gain  
P-1dB(IN) vs. V<sub>DD</sub>

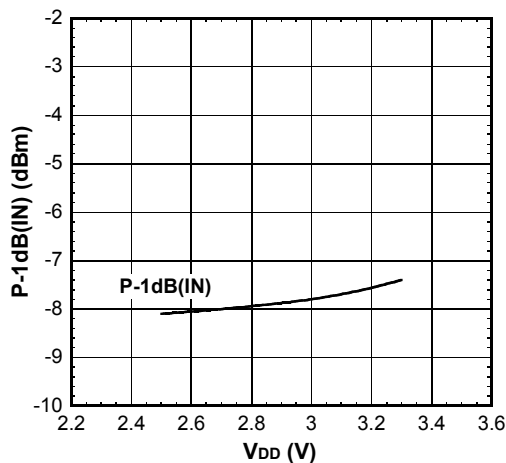

Condition

T<sub>a</sub>=+25°C,  
f=1495MHz,  
V<sub>CTL1</sub>=1.8V, V<sub>CTL2</sub>=1.8V, V<sub>CTL3</sub>=1.8V

1.5GHz @High Gain  
VSWR vs. V<sub>DD</sub>

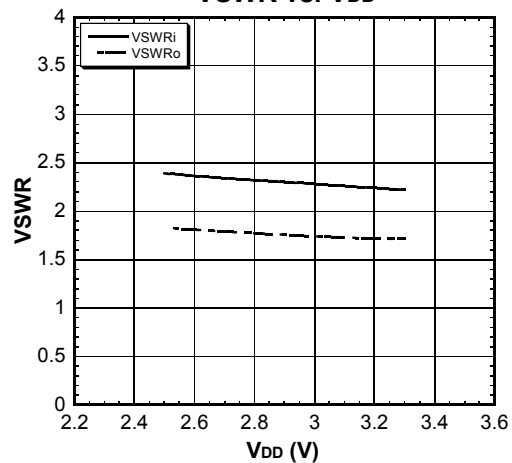

Condition

T<sub>a</sub>=+25°C,  
f=1495MHz,  
V<sub>CTL1</sub>=1.8V, V<sub>CTL2</sub>=1.8V, V<sub>CTL3</sub>=1.8V

## ■ELECTRICAL CHARACTERISTICS (1.5GHz band High Gain mode)

1.5GHz @High Gain  
I<sub>DD</sub> vs. V<sub>DD</sub>

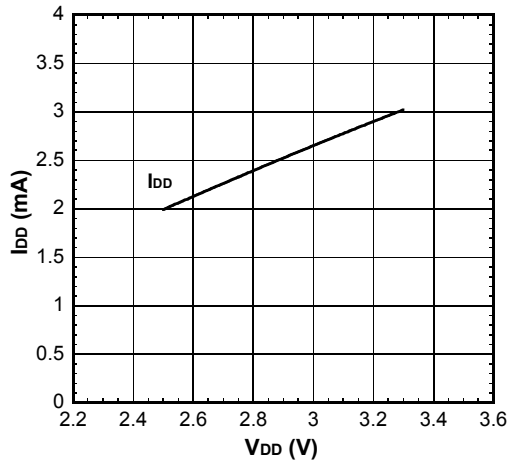

Condition

T<sub>a</sub>=+25°C,

RF=OFF

V<sub>CTL1</sub>=1.8V, V<sub>CTL2</sub>=1.8V, V<sub>CTL3</sub>=1.8V

# NJG1133MD7

## ■ ELECTRICAL CHARACTERISTICS (1.5GHz band High Gain mode)

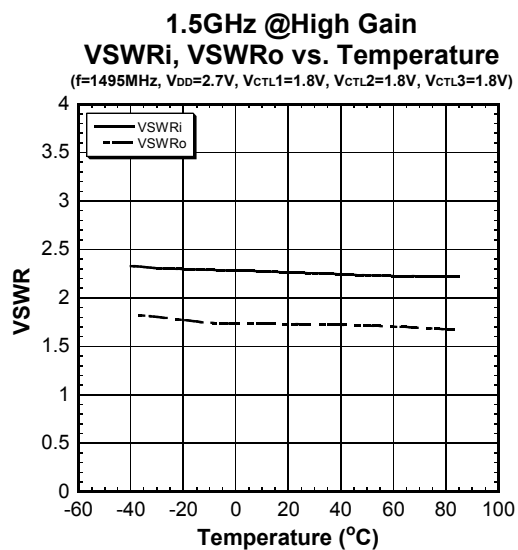
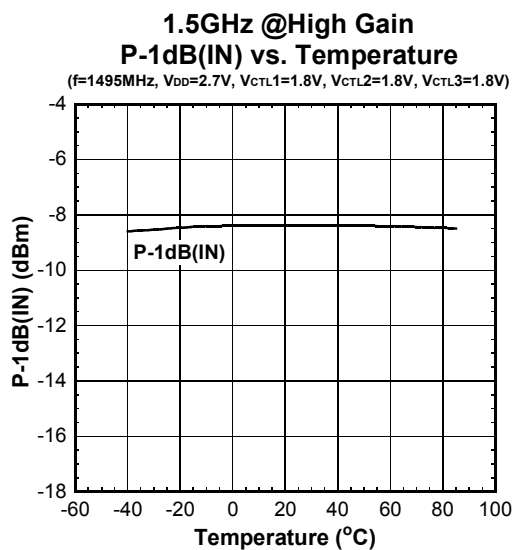
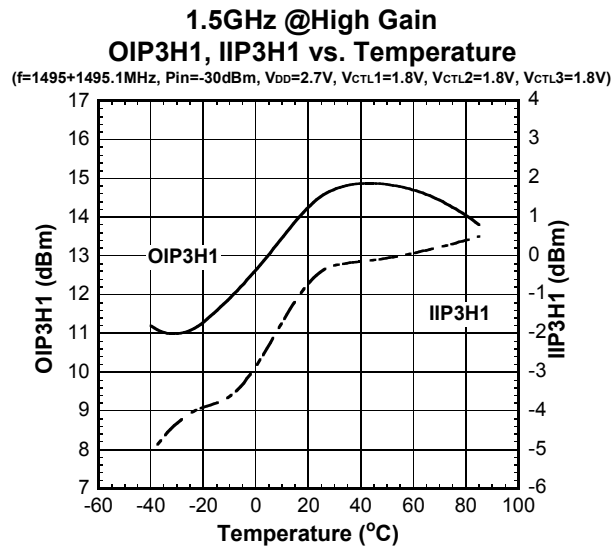
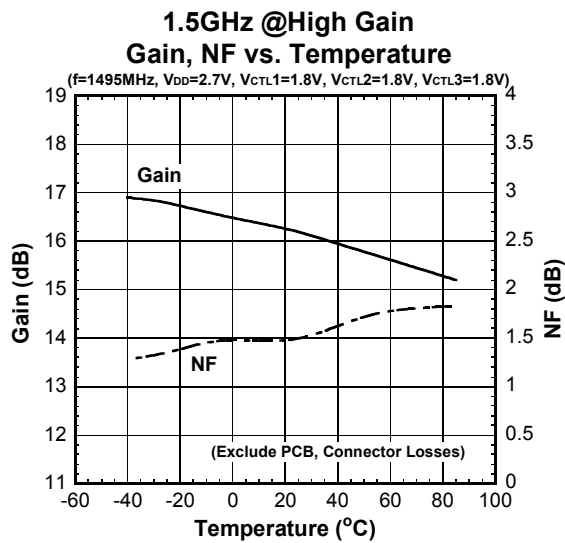

## ■ ELECTRICAL CHARACTERISTICS (1.5GHz band High Gain mode)

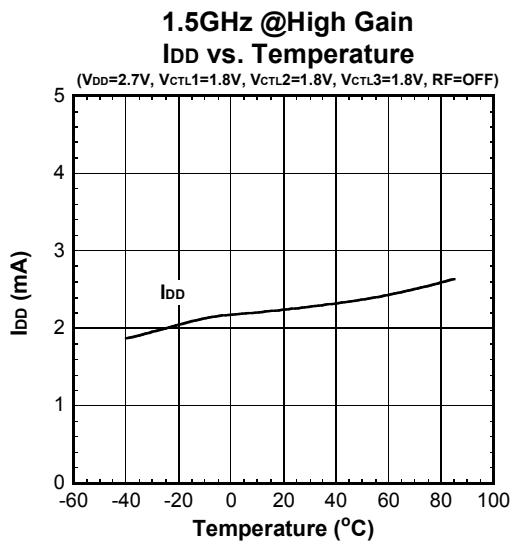

# NJG1133MD7

## ELECTRICAL CHARACTERISTICS (1.5GHz band High Gain mode)

Condition : Ta=+25°C, V<sub>DD</sub>= 2.7V, V<sub>CTL1</sub>=1.8V, V<sub>CTL2</sub>=1.8V, V<sub>CTL3</sub>=1.8V

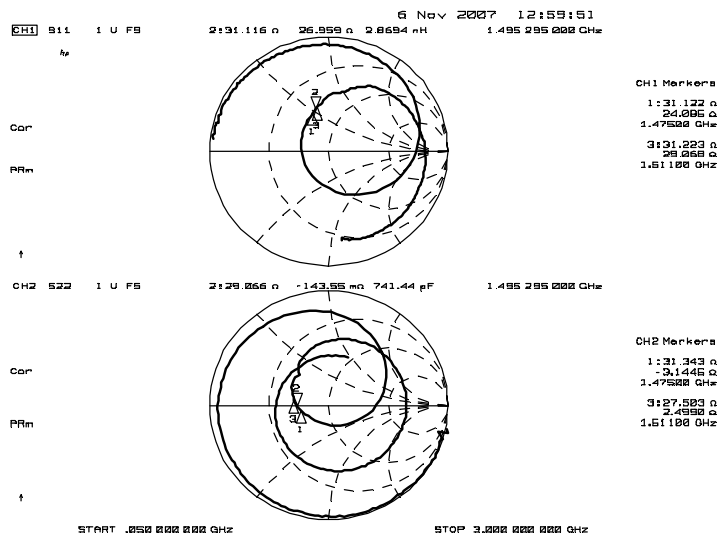
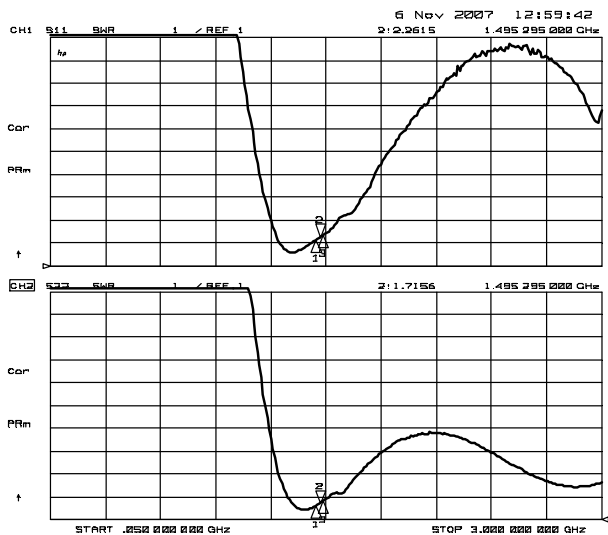
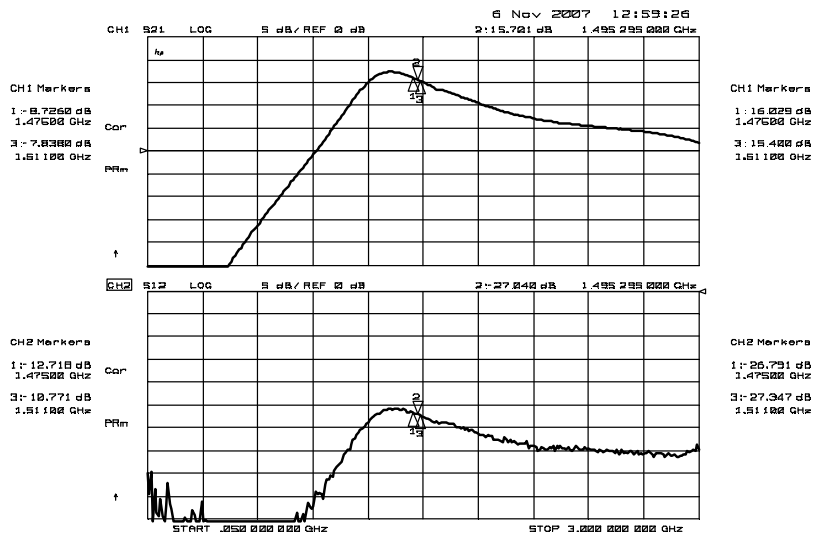
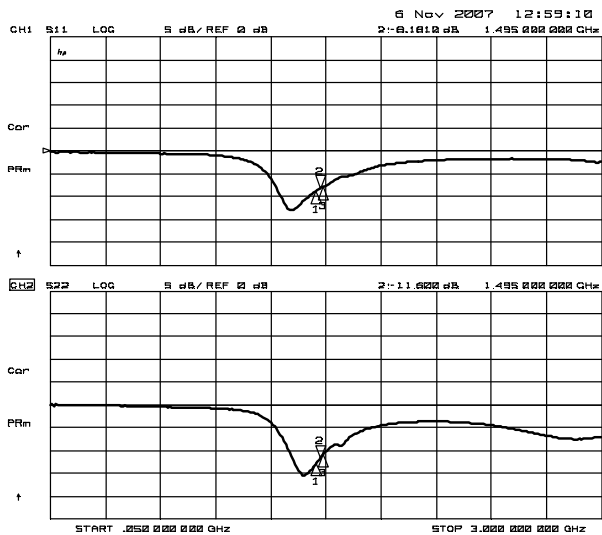

## ■ ELECTRICAL CHARACTERISTICS (1.5GHz band High Gain mode)

Condition :  $T_a = +25^\circ\text{C}$ ,  $V_{DD} = 2.7\text{V}$ ,  $V_{CTL1} = 1.8\text{V}$ ,  $V_{CTL2} = 1.8\text{V}$ ,  $V_{CTL3} = 1.8\text{V}$

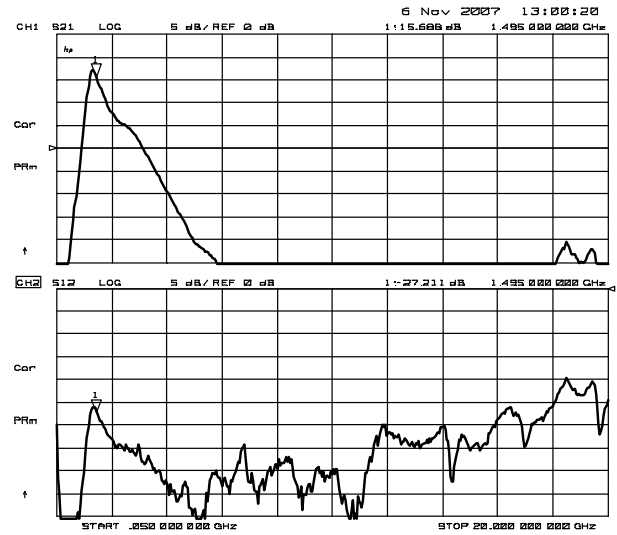
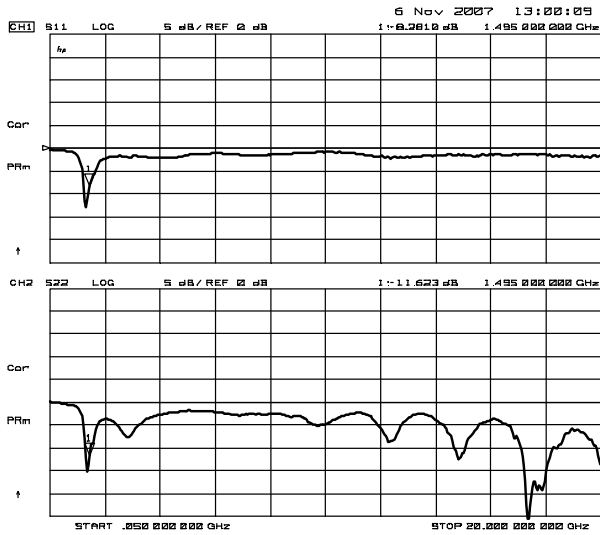

**1.5GHz @High Gain  
 k factor vs. frequency  
 (f=50MHz~20GHz)**

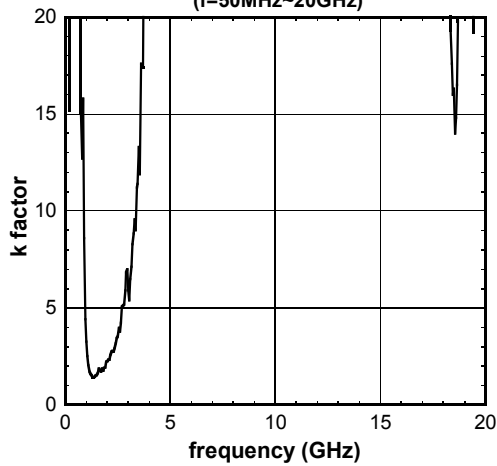

# NJG1133MD7

## ■ ELECTRICAL CHARACTERISTICS (1.5GHz band Low Gain mode)

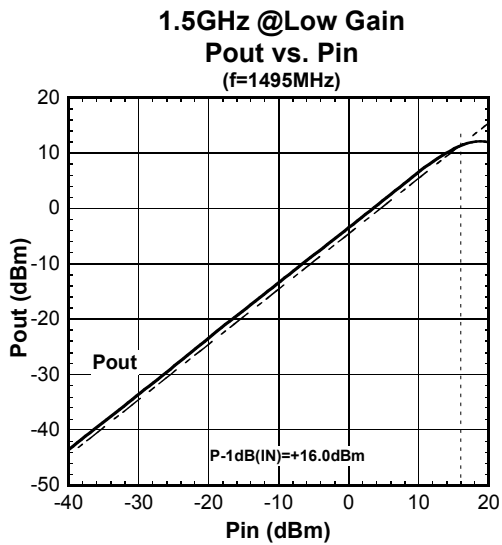

Condition  
 $T_a = +25^\circ\text{C}$ ,  
 $V_{DD} = 2.7\text{V}$ ,  
 $V_{CTL1} = 1.8\text{V}$ ,  $V_{CTL2} = 1.8\text{V}$ ,  $V_{CTL3} = 0\text{V}$

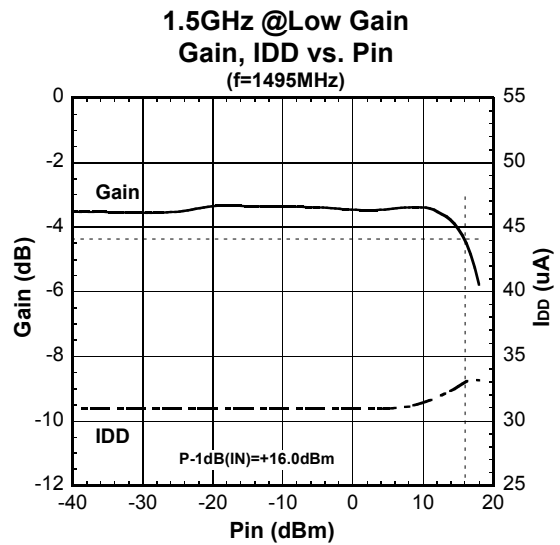

Condition  
 $T_a = +25^\circ\text{C}$ ,  
 $V_{DD} = 2.7\text{V}$ ,  
 $V_{CTL1} = 1.8\text{V}$ ,  $V_{CTL2} = 1.8\text{V}$ ,  $V_{CTL3} = 0\text{V}$

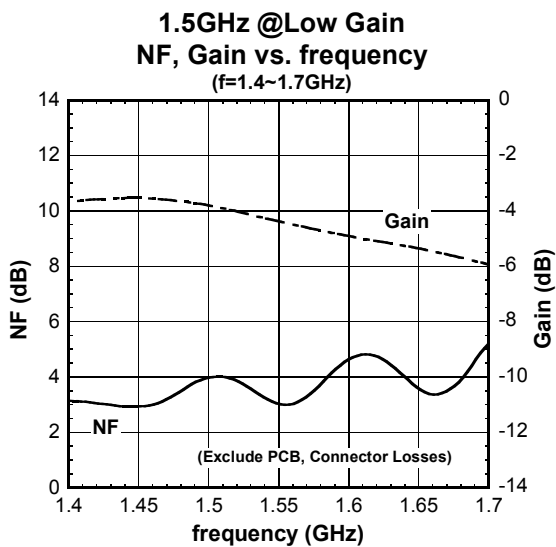

Condition  
 $T_a = +25^\circ\text{C}$ ,  
 $V_{DD} = 2.7\text{V}$ ,  
 $V_{CTL1} = 1.8\text{V}$ ,  $V_{CTL2} = 1.8\text{V}$ ,  $V_{CTL3} = 0\text{V}$

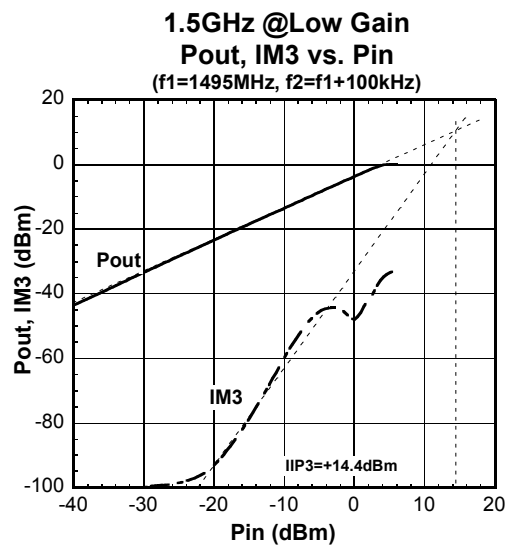

Condition  
 $T_a = +25^\circ\text{C}$ ,  
 $V_{DD} = 2.7\text{V}$ ,  
 $V_{CTL1} = 1.8\text{V}$ ,  $V_{CTL2} = 1.8\text{V}$ ,  $V_{CTL3} = 0\text{V}$



## ■ELECTRICAL CHARACTERISTICS (1.5GHz band Low Gain mode)

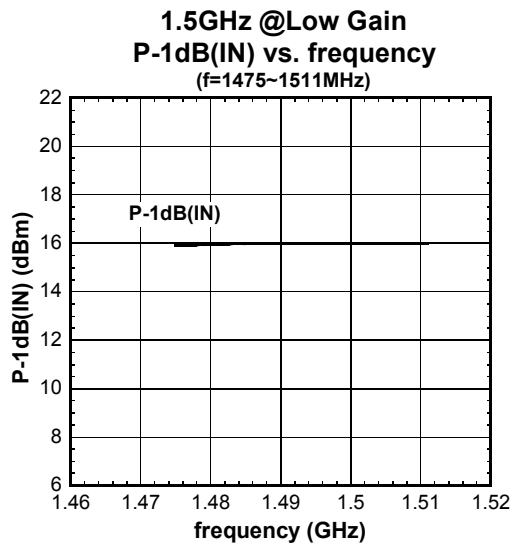

Condition

Ta=+25°C,  
V<sub>DD</sub>= 2.7V,  
V<sub>CTL1</sub>=1.8V, V<sub>CTL2</sub>=1.8V, V<sub>CTL3</sub>=0V

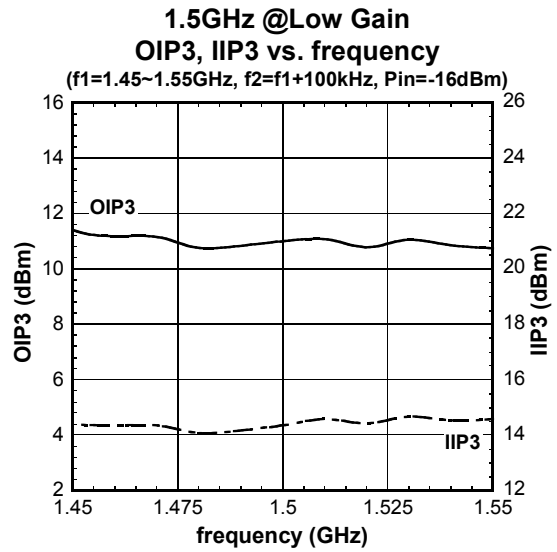

Condition

Ta=+25°C,  
V<sub>DD</sub>= 2.7V,  
V<sub>CTL1</sub>=1.8V, V<sub>CTL2</sub>=1.8V, V<sub>CTL3</sub>=0V

# NJG1133MD7

## ■ ELECTRICAL CHARACTERISTICS (1.5GHz band Low Gain mode)

1.5GHz @Low Gain  
Gain, NF vs. V<sub>DD</sub>

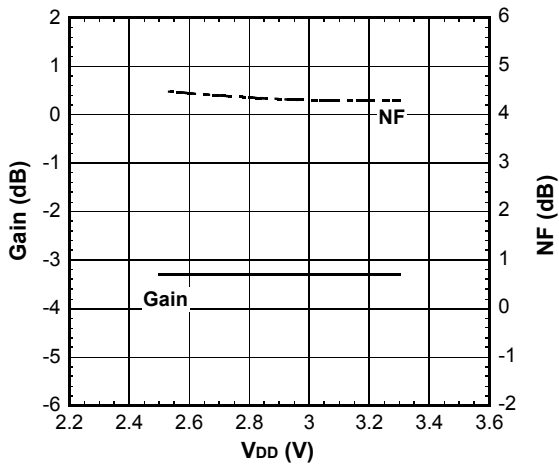

Condition

T<sub>a</sub>=+25°C,  
f=1495MHz,  
V<sub>CTL1</sub>=1.8V, V<sub>CTL2</sub>=1.8V, V<sub>CTL3</sub>=0V

1.5GHz @Low Gain  
OIP3, IIP3 vs. V<sub>DD</sub>

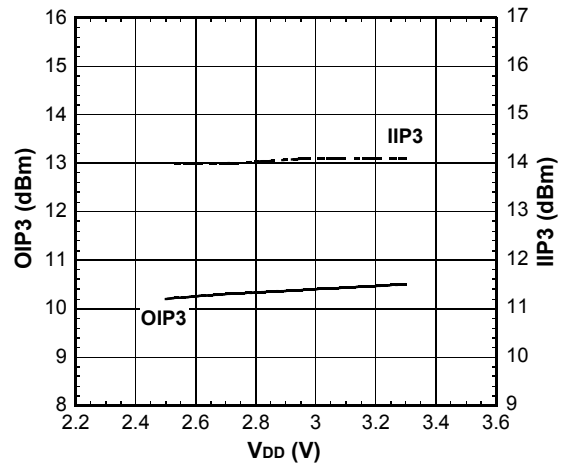

Condition

T<sub>a</sub>=+25°C,  
f<sub>1</sub>=1495MHz, f<sub>2</sub>=f<sub>1</sub>+100kHz,  
Pin=-16dBm,  
V<sub>CTL1</sub>=1.8V, V<sub>CTL2</sub>=1.8V, V<sub>CTL3</sub>=0V

1.5GHz @Low Gain  
P-1dB(IN) vs. V<sub>DD</sub>

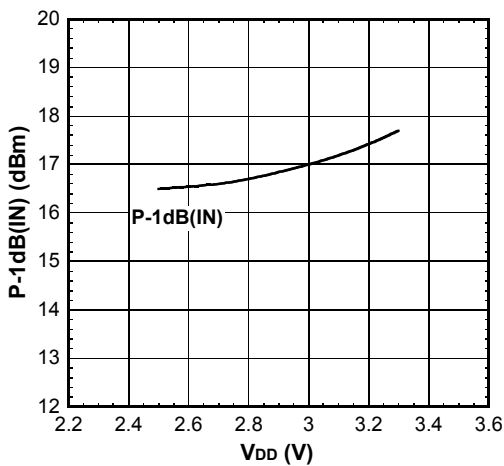

Condition

T<sub>a</sub>=+25°C,  
f=1495MHz,  
V<sub>CTL1</sub>=1.8V, V<sub>CTL2</sub>=1.8V, V<sub>CTL3</sub>=0V

1.5GHz @Low Gain  
VSWR vs. V<sub>DD</sub>

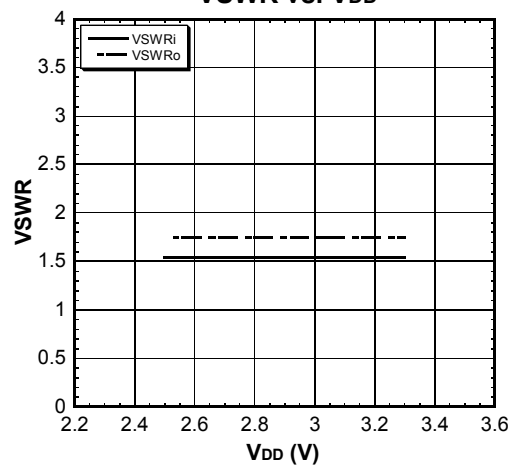

Condition

T<sub>a</sub>=+25°C,  
f=1495MHz,  
V<sub>CTL1</sub>=1.8V, V<sub>CTL2</sub>=1.8V, V<sub>CTL3</sub>=0V

## ■ELECTRICAL CHARACTERISTICS (1.5GHz band Low Gain mode)

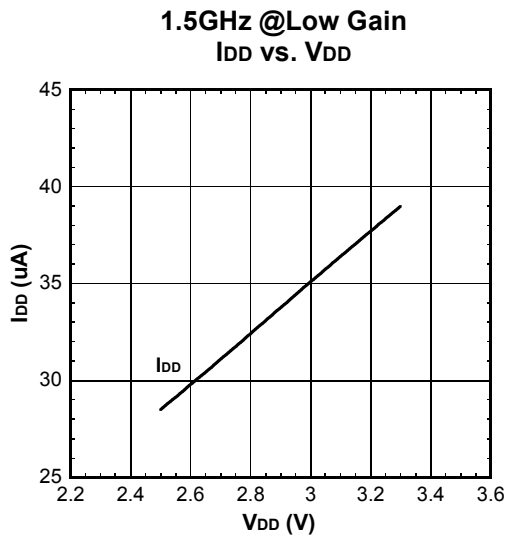

Condition

T<sub>a</sub>=+25°C,

RF=OFF,

V<sub>CTL1</sub>=1.8V, V<sub>CTL2</sub>=1.8V, V<sub>CTL3</sub>=0V

# NJG1133MD7

## ■ ELECTRICAL CHARACTERISTICS (1.5GHz band Low Gain mode)

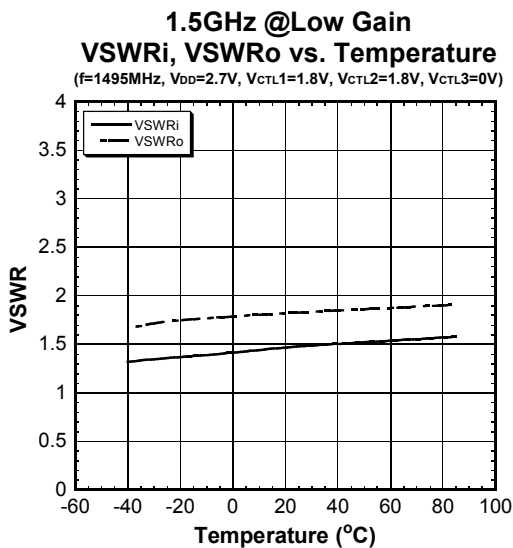
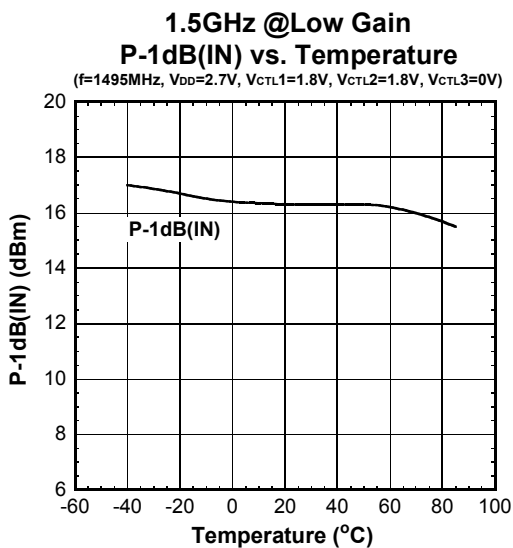
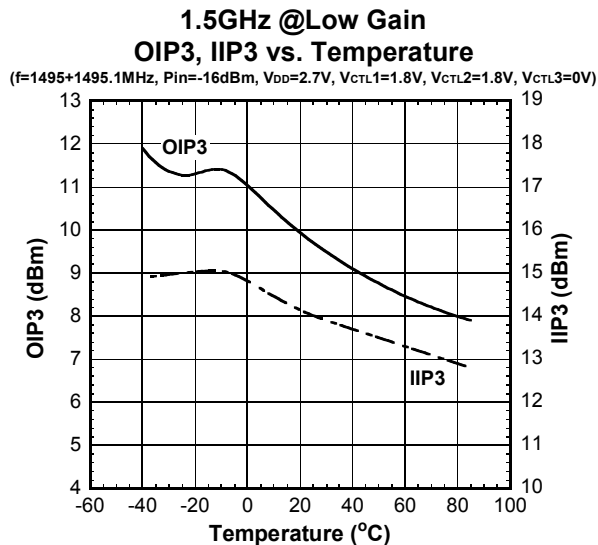
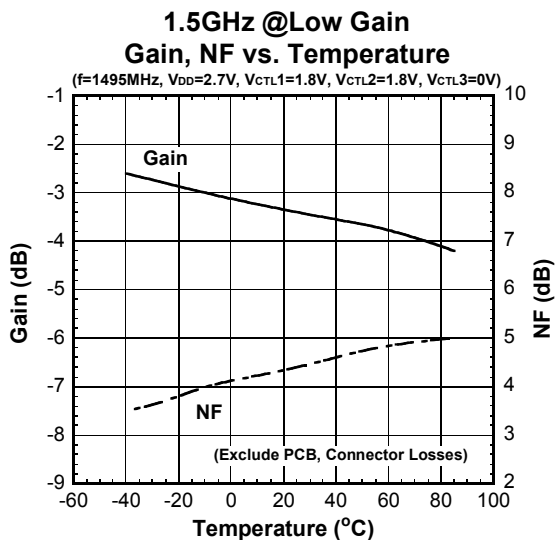

## ■ ELECTRICAL CHARACTERISTICS (1.5GHz band Low Gain mode)

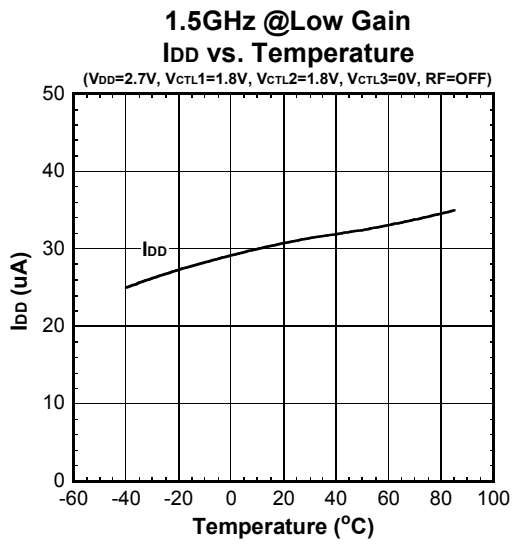

# NJG1133MD7

## ELECTRICAL CHARACTERISTICS (1.5GHz band Low Gain mode)

Condition : Ta=+25°C, V<sub>DD</sub>= 2.7V, V<sub>CTL1</sub>=1.8V, V<sub>CTL2</sub>=1.8V, V<sub>CTL3</sub>=0V

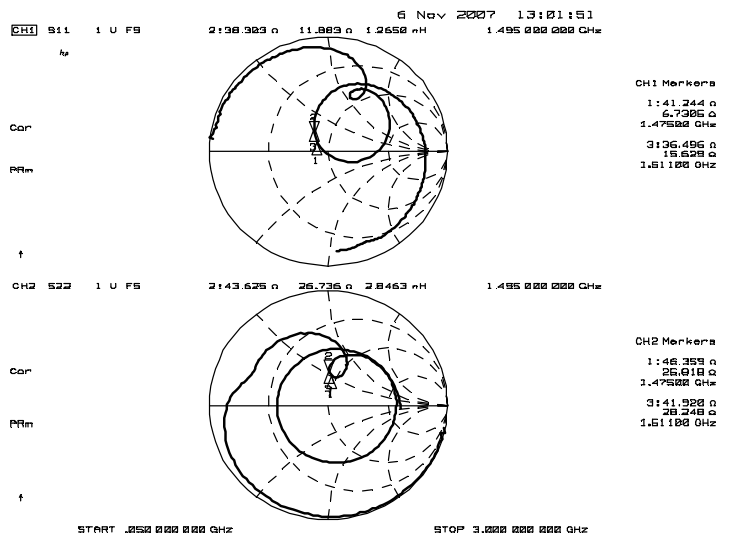
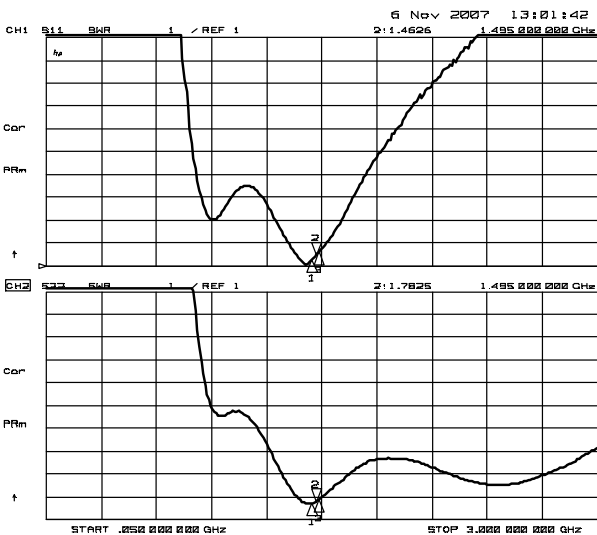
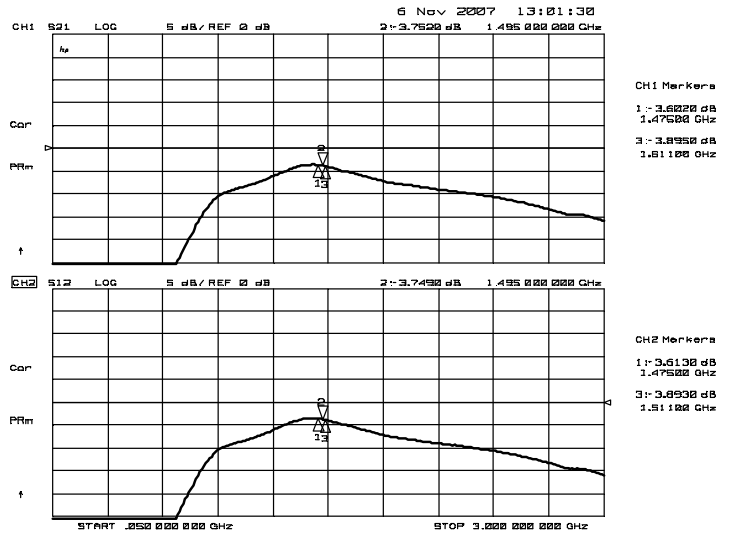
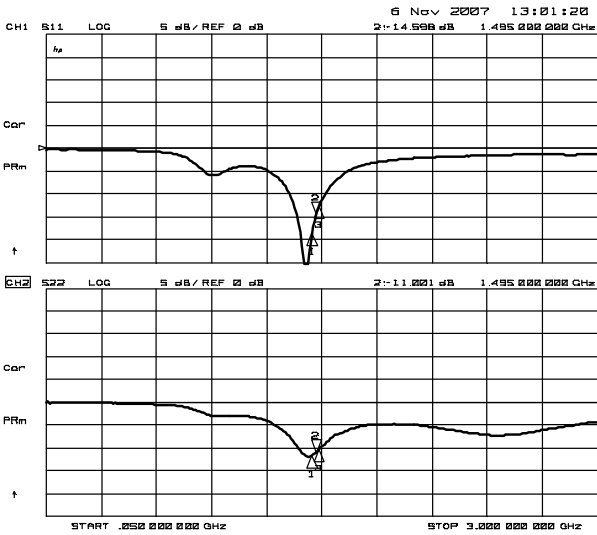

## ■ELECTRICAL CHARACTERISTICS (1.5GHz band Low Gain mode)

Condition :  $T_a = +25^\circ\text{C}$ ,  $V_{DD} = V_{INV} = 2.7\text{V}$ ,  $V_{CTL1} = 1.8\text{V}$ ,  $V_{CTL2} = 1.85\text{V}$ ,  $V_{CTL3} = 0\text{V}$

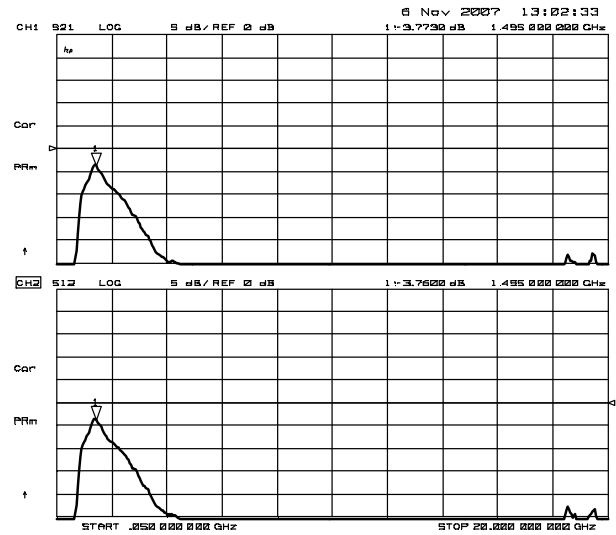
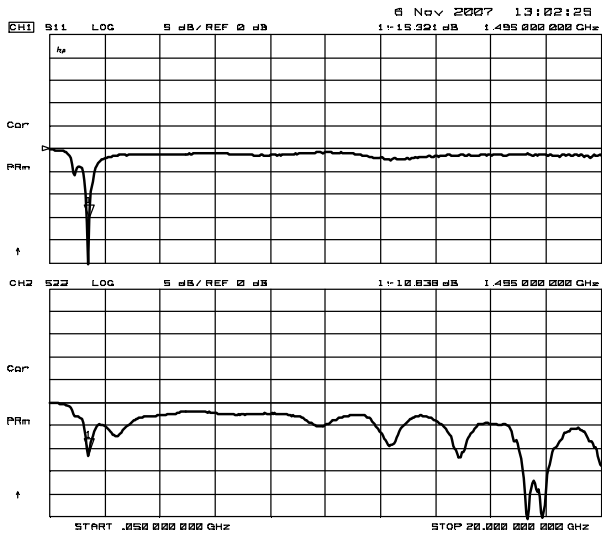

**1.5GHz @Low Gain  
 k factor vs. frequency  
 (f=50MHz~20GHz)**

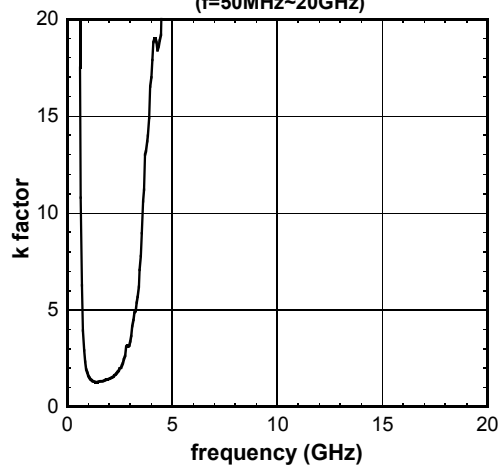

# NJG1133MD7

## APPLICATION CIRCUIT 1 (2.1GHz/800MHz/1.7GHz Band)

(Top View)

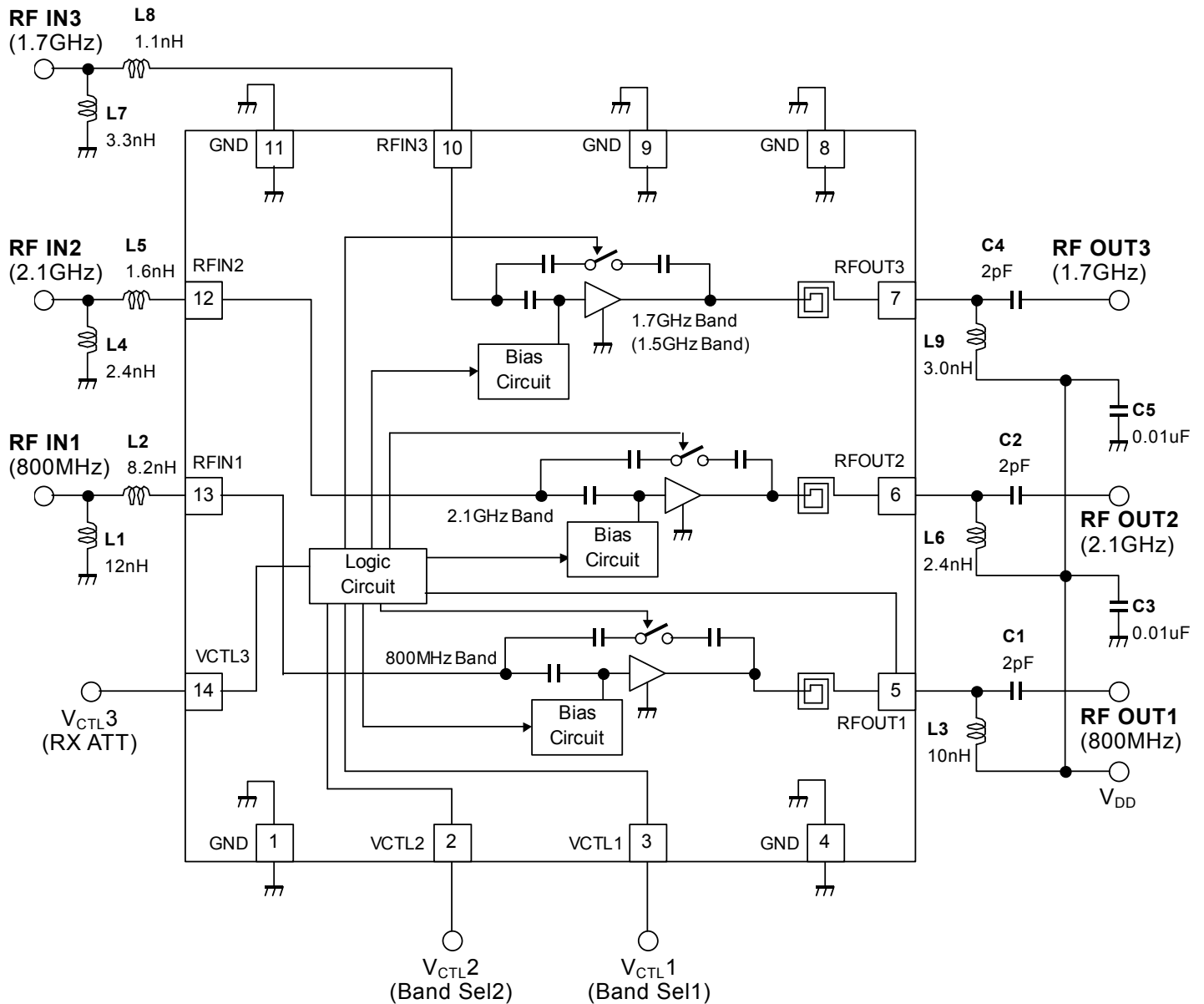

### PARTS LIST

Parts ID	Notes
L1, L2, L4 ~L9	MURATA (LQP03T) 0603 Size
L3	TDK (MLK0603) 0603 Size
C1~C5	MURATA (GRM03) 0603 Size

### PRECAUTIONS

- 1) Please locate bypass capacitor C3 proximity to inductor L3 and L6.
- 2) Please locate bypass capacitor C5 proximity to inductor L9.
- 3) Ground terminal should be connected with the ground plane as short as possible.



## APPLICATION CIRCUIT 2 (2.1GHz/800MHz/1.5GHz Band)

(Top View)

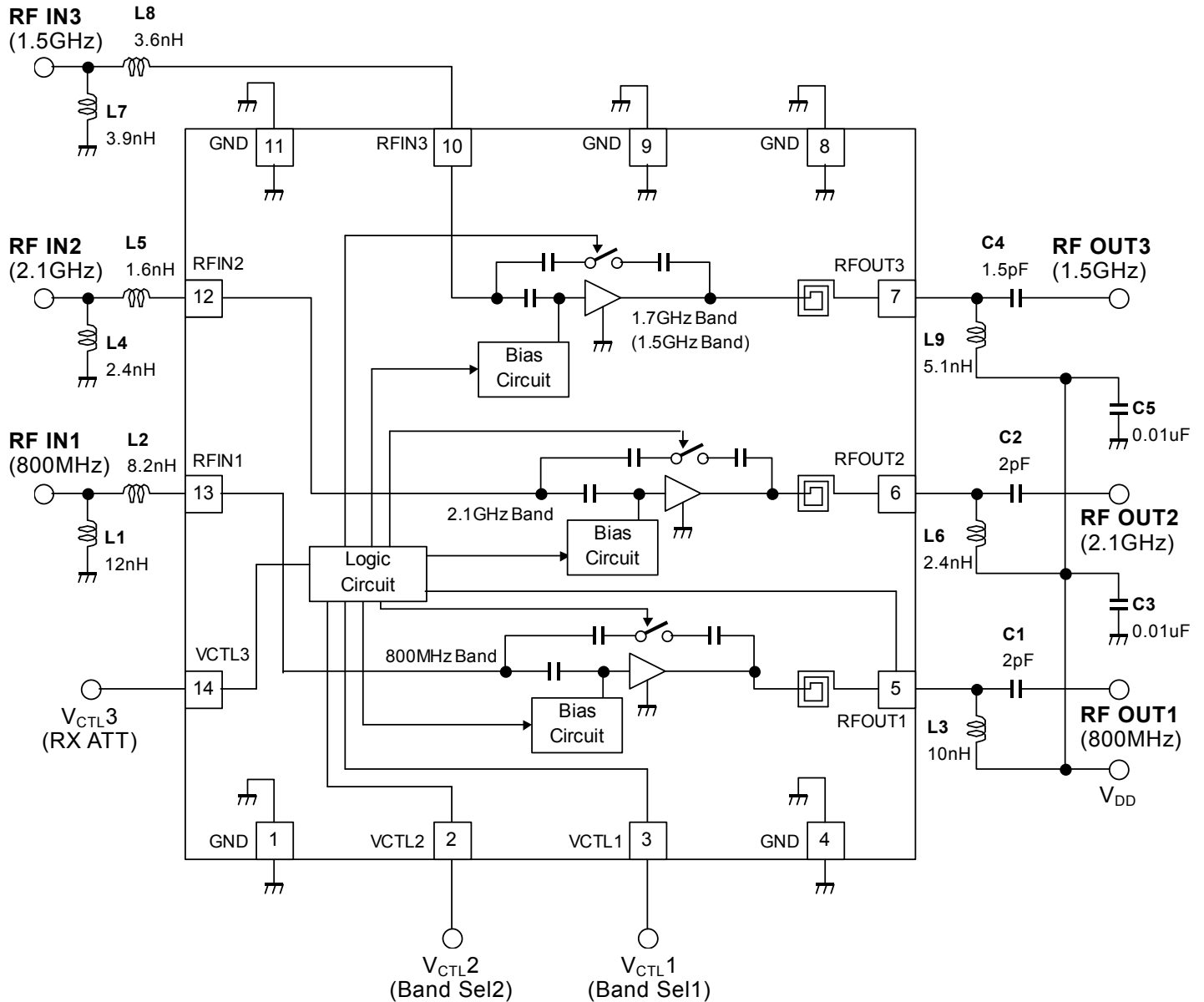

### PARTS LIST

Parts ID	Notes
L1, L2, L4 ~L9	MURATA (LQP03T) 0603 Size
L3	TDK (MLK0603) 0603 Size
C1~C5	MURATA (GRM03) 0603 Size

### PRECAUTIONS

- 1) Please locate bypass capacitor C3 proximity to inductor L3 and L6.
- 2) Please locate bypass capacitor C5 proximity to inductor L9.
- 3) Ground terminal should be connected with the ground plane as short as possible.

# NJG1133MD7

## TEST PCB LAYOUT

(Top View)

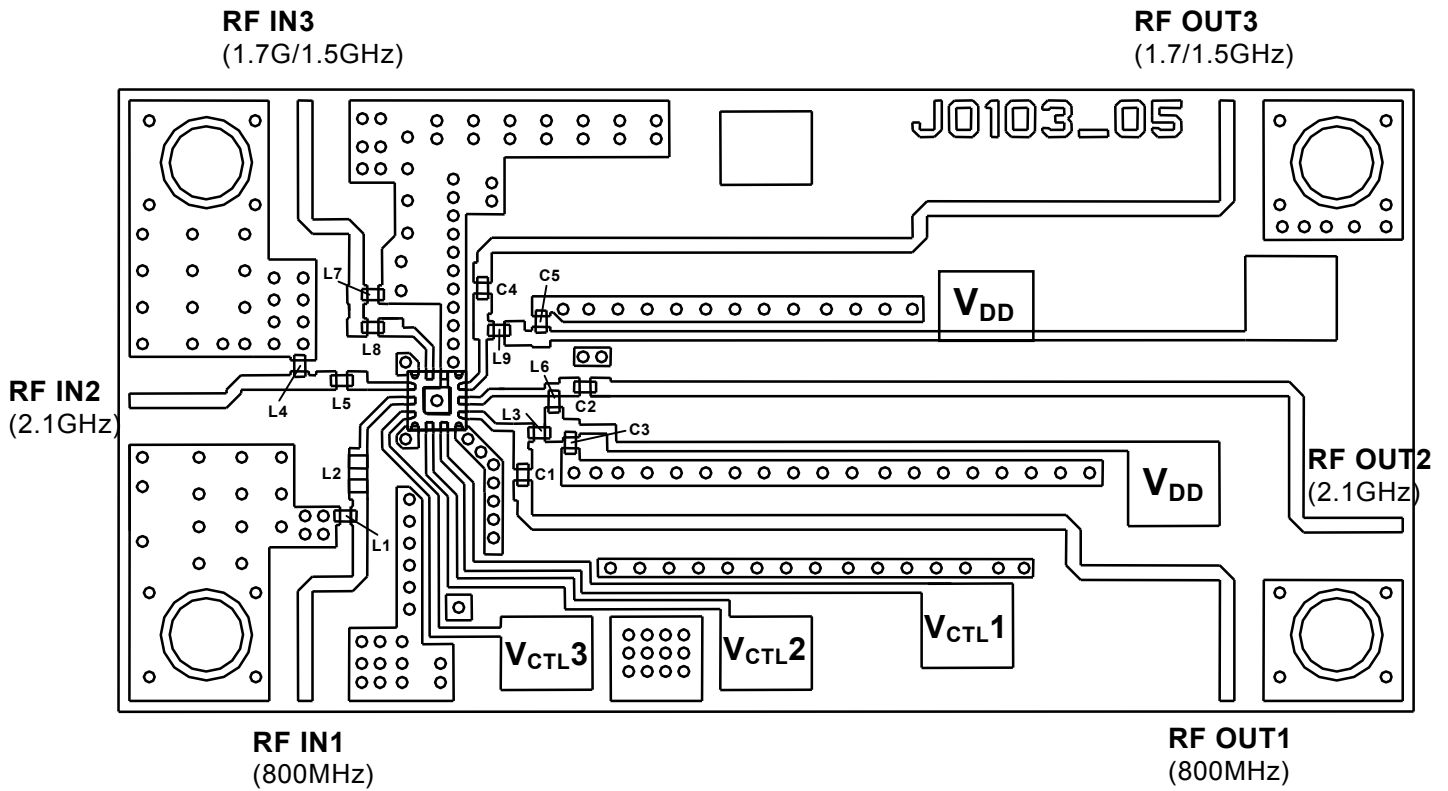

PCB (FR-4):

t=0.2mm

MICROSTRIP LINE WIDTH=0.4mm ( $Z_0=50\text{ohm}$ )

PCB SIZE=35.4mm x 17.0mm

