

5GHz BAND LOW NOISE AMPLIFIER GaAs MMIC

■ GENERAL DESCRIPTION

NJG1148MD7 is a 5GHz band low noise amplifier GaAs MMIC designed for wireless LAN, wireless image transmission and Intelligent Transport System.

The NJG1148MD7 has a LNA pass-through function to select high gain mode or low gain mode by low control voltage operation. Within the wide dynamic range from 4.9~5.95GHz, the NJG1148MD7 achieves low noise figure and high linearity with fewer external components. The ESD protection circuits are integrated into the MMIC. They achieve high ESD protection voltage.

A small and ultra-thin package of EQFN14-D7 is adopted.

■ PACKAGE OUTLINE

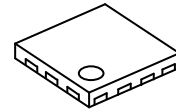

NJG1148MD7

■ APPLICATIONS

5GHz Band application from 4.9GHz to 5.95GHz

Wireless LAN, wireless image transmission and Intelligent transport System applications

■ FEATURES

- Operating voltage 3.3V
- Low current consumption 7.0mA typ. @ $V_{DD}=3.3V$, $V_{CTL}=1.8V$ (LNA mode)
5 μ A typ. @ $V_{DD}=3.3V$, $V_{CTL}=0V$ (Bypass mode)
- High Gain 12.5dB typ. @ $V_{DD}=3.3V$, $V_{CTL}=1.8V$ (LNA mode)
- Low Noise figure 1.5dB typ. @ $V_{DD}=3.3V$, $V_{CTL}=1.8V$ (LNA mode)
- High IIP3 +5.0dBm typ. @ $V_{DD}=3.3V$, $V_{CTL}=1.8V$ (LNA mode)
- Low Insertion Loss 5.0dB typ. @ $V_{DD}=3.3V$, $V_{CTL}=0V$ (Bypass mode)
- Few external components 1pc (Bypass Capacitor)
- Small package size EQFN14-D7 (Package size: 1.6mm x 1.6mm x 0.397mm typ.)
- Pb free, Halogen free

■ PIN CONFIGURATION

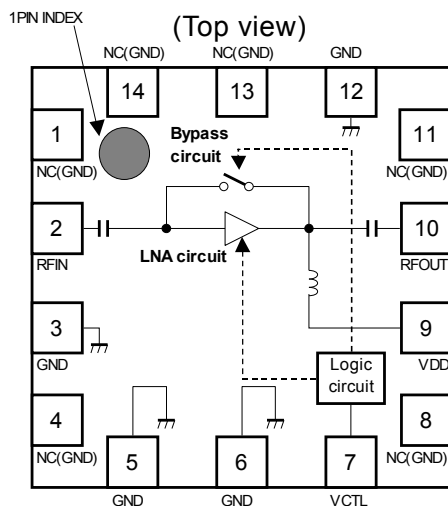

Pin Connection

- | | |
|-------------|--------------|
| 1. NC (GND) | 8. NC (GND) |
| 2. RFIN | 9. VDD |
| 3. GND | 10. RFOUT |
| 4. NC (GND) | 11. NC (GND) |
| 5. GND | 12. GND |
| 6. GND | 13. NC (GND) |
| 7. VCTL | 14. NC (GND) |

■ TRUTH TABLE

“H”= $V_{CTL(H)}$ “L”= $V_{CTL(L)}$

V_{CTL}	LNA Circuit	Bypass Circuit	Operating mode
H	ON	OFF	LNA mode
L	OFF	ON	Bypass mode

Note: Specifications and description listed in this datasheet are subject to change without notice

■ ABSOLUTE MAXIMUM RATINGS

$T_a=+25^{\circ}\text{C}$, $Z_s=Z_l=50\Omega$

PARAMETER	SYMBOL	CONDITIONS	RATINGS	UNITS
Drain voltage	V_{DD}		5.0	V
Control voltage	V_{CTL}		5.0	V
Input power	P_{in}	$V_{DD}=3.3\text{V}$	+15	dBm
Power dissipation	P_D	4-layer FR4 PCB with through-hole (76.2x114.3mm), $T_j=150^{\circ}\text{C}$	1300	mW
Operating temperature	T_{opr}		-40~+85	$^{\circ}\text{C}$
Storage temperature	T_{stg}		-55~+150	$^{\circ}\text{C}$

■ ELECTRICAL CHARACTERISTICS 1 (DC CHARACTERISTICS)

$V_{DD}=3.3\text{V}$, $T_a=+25^{\circ}\text{C}$, $Z_s=Z_l=50\Omega$

PARAMETERS	SYMBOL	CONDITIONS	MIN	TYP	MAX	UNITS
Operating voltage	V_{DD}		2.7	3.3	4.5	V
Control voltage (High)	$V_{CTL(H)}$		1.6	1.8	4.5	V
Control voltage (Low)	$V_{CTL(L)}$		0	0	0.4	V
Operating current1	I_{DD1}	RF OFF, $V_{CTL}=1.8\text{V}$	-	7.0	11.0	mA
Operating current2	I_{DD2}	RF OFF, $V_{CTL}=0\text{V}$	-	5	9	μA
Control current	I_{CTL}	RF OFF, $V_{CTL}=1.8\text{V}$	-	6	10	μA

■ ELECTRICAL CHARACTERISTICS 2 (LNA mode)

$V_{DD}=3.3V$, $V_{CTL}=1.8V$, $freq=4900\sim 5950MHz$, $T_a=+25^\circ C$, $Z_s=Z_l=50\Omega$, with application circuit

PARAMETERS	SYMBOL	CONDITIONS	MIN	TYP	MAX	UNITS
Small signal gain	Gain	Exclude PCB & connector losses *1	9.5	12.5	16.0	dB
Noise figure	NF	Exclude PCB & connector losses *2	-	1.5	2.2	dB
Input power at 1dB gain compression point1	P-1dB (IN)1		-12.0	-5.0	-	dBm
Input 3rd order intercept point1	IIP3_1	f1=freq, f2=freq+100kHz, P _{IN} =-25dBm	0.0	+5.0	-	dBm
Input Tx Power at 1dB Gain Compression Point	Psat (Tx-1dB)	Fundamental frequency: f1=5500MHz, Pin=-30dBm Tx frequency: f2=1710MHz, 1940MHz, 2170MHz Input Tx Power at 1dB fundamental Gain compression point	-17.0	-8.0	-	dBm
Isolation	ISL		-	35.0	-	dB
RF IN Return loss1	RLi1		8.0	12.0	-	dB
RF OUT Return loss1	RLo1		5.0	12.0	-	dB

*1 Input & output PCB and connector losses: 0.58dB (5500MHz)

*2 Input PCB and connector losses: 0.29dB (5500MHz)

■ ELECTRICAL CHARACTERISTICS 3 (Bypass mode)

$V_{DD}=3.3V$, $V_{CTL}=0V$, $freq=4900\sim 5950MHz$, $T_a=+25^\circ C$, $Z_s=Z_l=50\Omega$, with application circuit

PARAMETERS	SYMBOL	CONDITIONS	MIN	TYP	MAX	UNITS
Insertion Loss	Loss	Exclude PCB & connector losses *1	-	5.0	7.0	dB
Input power at 1dB gain compression point2	P-1dB (IN)2		-1.0	+10.0	-	dBm
Input 3rd order intercept point2	IIP3_2	f1=freq, f2=freq+100kHz, P _{IN} =-10dBm	+3.0	+10.0	-	dBm
RF IN Return loss2	RLi2		7.0	12.0	-	dB
RF OUT Return loss2	RLo2		8.0	12.0	-	dB

*1 Input & output PCB and connector losses: 0.58dB (5500MHz)

■ TERMINAL INFORMATION

No.	SYMBOL	DESCRIPTION
1, 4, 8, 11, 13, 14	NC(GND)	No connected terminal. This terminal is not connected with internal circuit. Please connect this terminal with ground place as close as possible for excellent RF performance.
2	RFIN	RF input terminal. This IC integrates an input DC blocking capacitor.
3, 5, 6, 12	GND	Ground terminal. This terminal should be connected to the ground plane as close as possible for excellent RF performance.
7	VCTL	Control voltage terminal.
9	VDD	Supply voltage terminal for LNA and logic circuit. Bypass to ground with capacitor C1 as close as possible to the IC.
10	RFOUT	RF output terminal. This IC integrates an input DC blocking capacitor.

■ ELECTRICAL CHARACTERISTICS (LNA mode)

Conditions: $V_{DD}=3.3V$, $V_{CTL}=1.8V$, $T_a=25^{\circ}C$, $Z_s=Z_l=50\Omega$, with application circuit

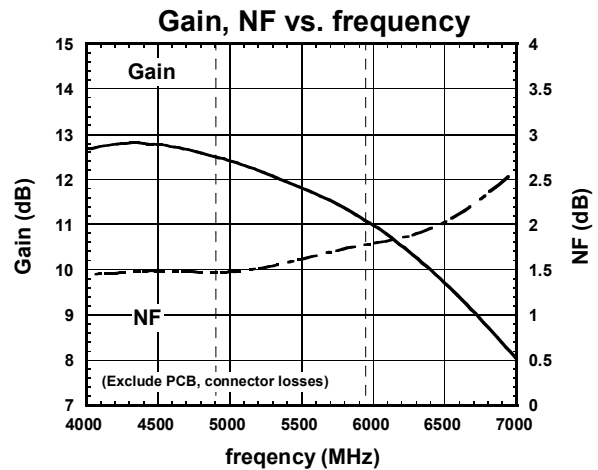
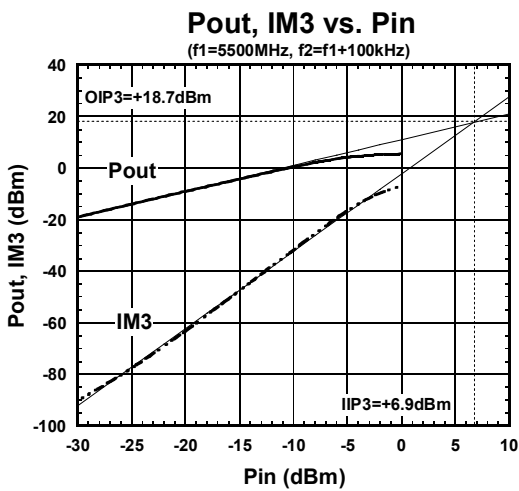
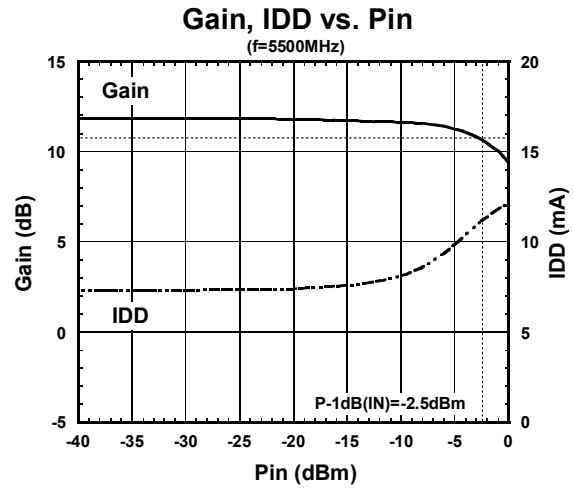
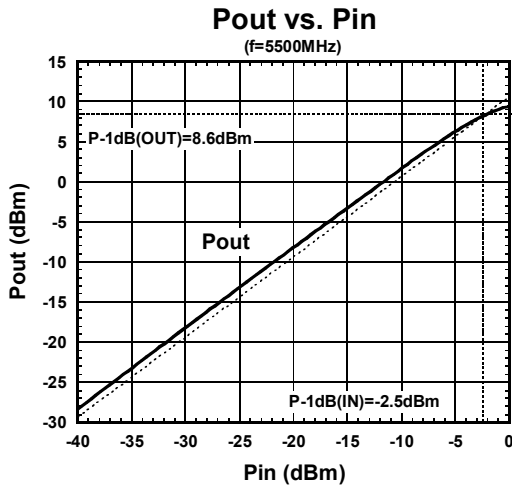

■ ELECTRICAL CHARACTERISTICS (LNA mode)

Conditions: $V_{DD}=3.3V$, $V_{CTL}=1.8V$, $T_a=25^{\circ}C$, $Z_s=Z_l=50\Omega$, with application circuit

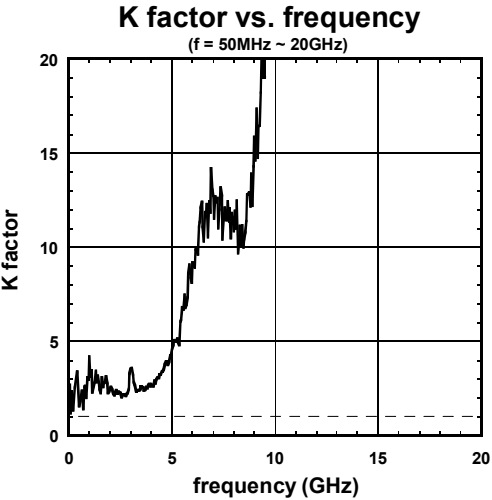
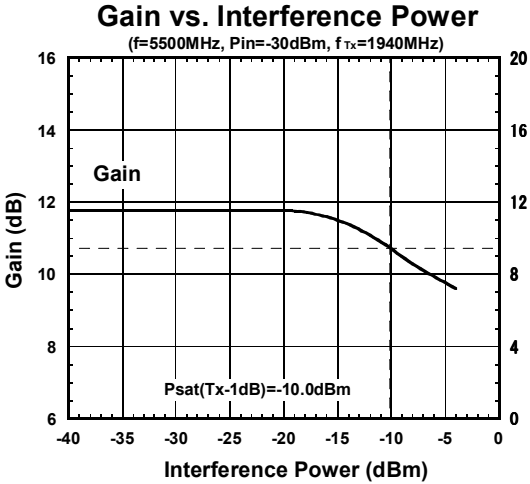
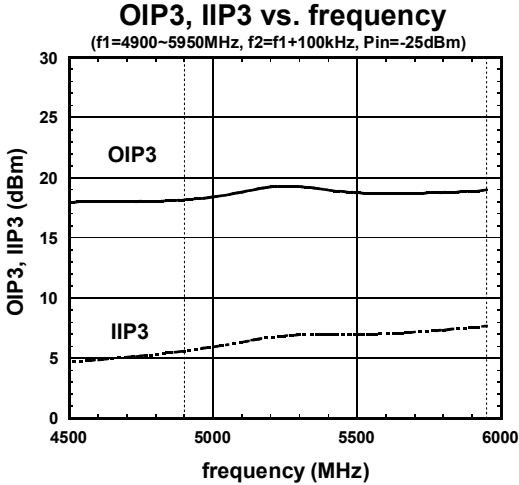
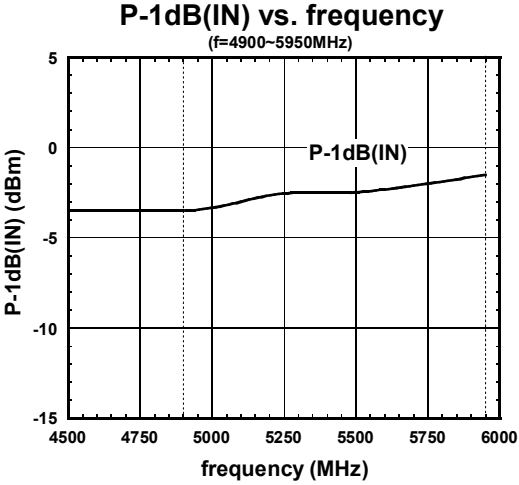

■ ELECTRICAL CHARACTERISTICS (LNA mode)

Conditions: $V_{DD}=3.3V$, $V_{CTL}=1.8V$, $T_a=25^\circ C$, $Z_s=Z_l=50\Omega$, with application circuit

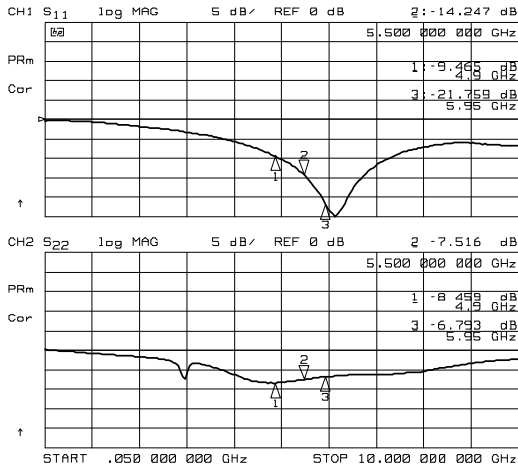

S11, S22 (0.05~10GHz)

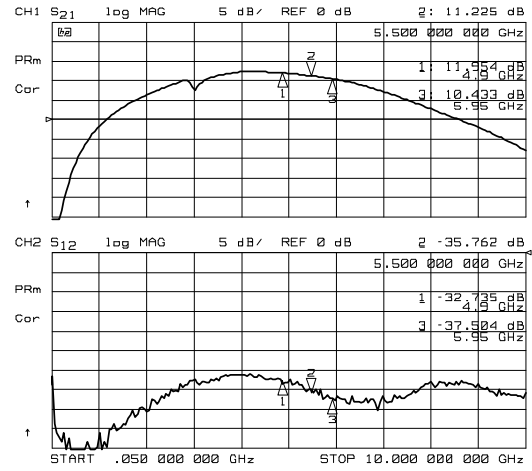

S21, S12 (0.05~10GHz)

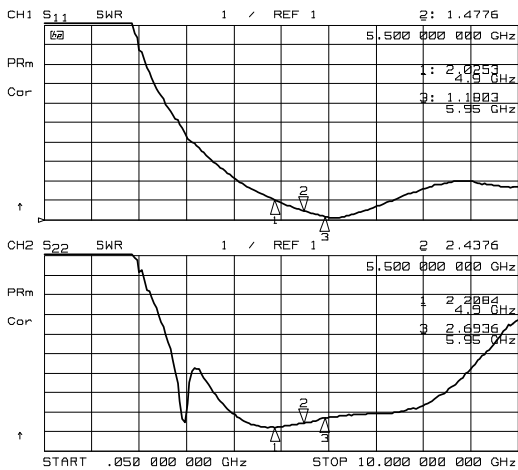

VSWRi, VSWRo (0.05~10GHz)

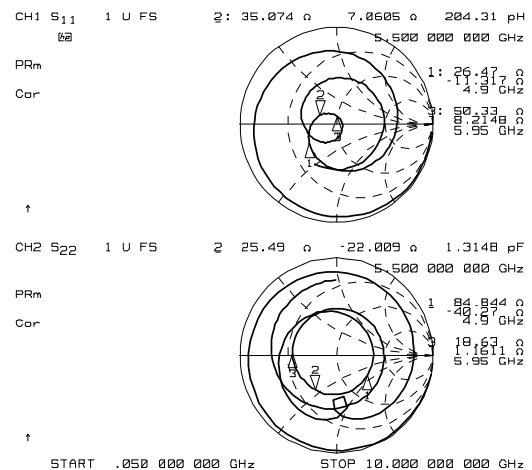

Zin, Zout (0.05~10GHz)

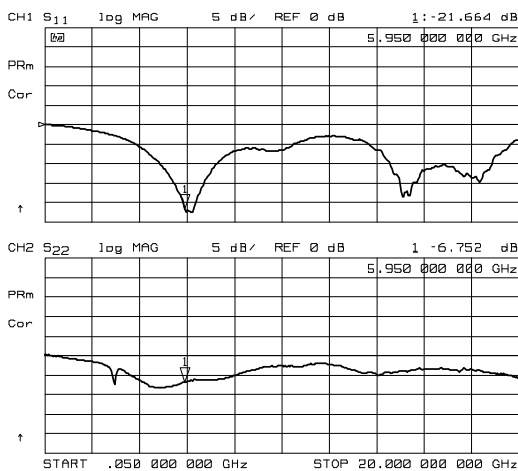

S11, S22 (0.05~20GHz)

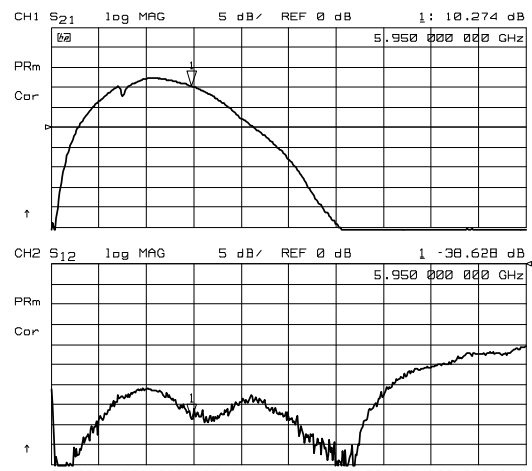

S21, S12 (0.05~20GHz)

■ ELECTRICAL CHARACTERISTICS (LNA mode)

Conditions: $V_{CTL}=1.8V$, $T_a=25^\circ C$, $Z_s=Z_L=50\Omega$, with application circuit

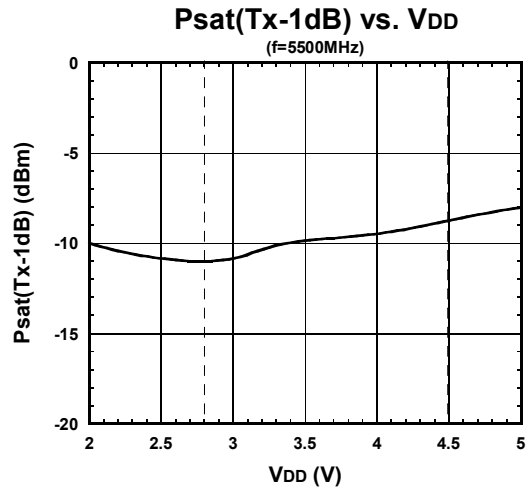
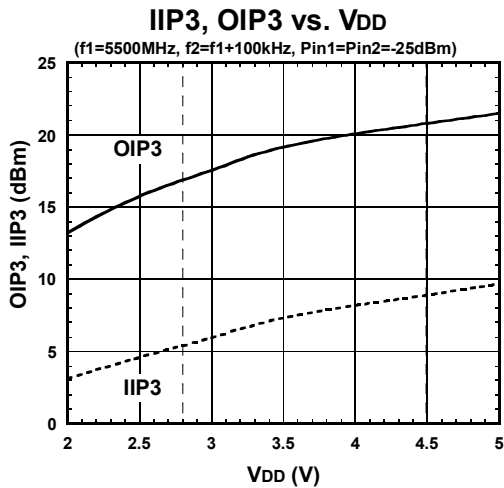
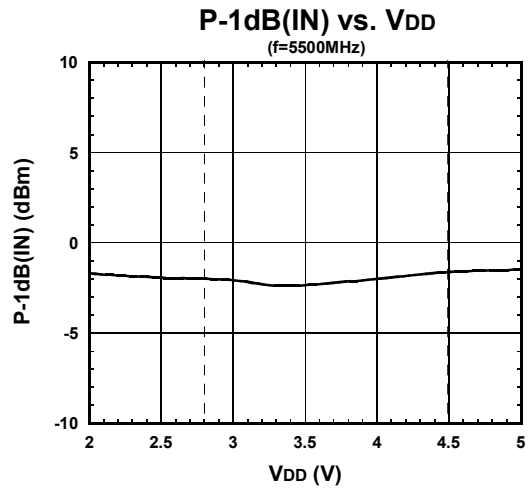
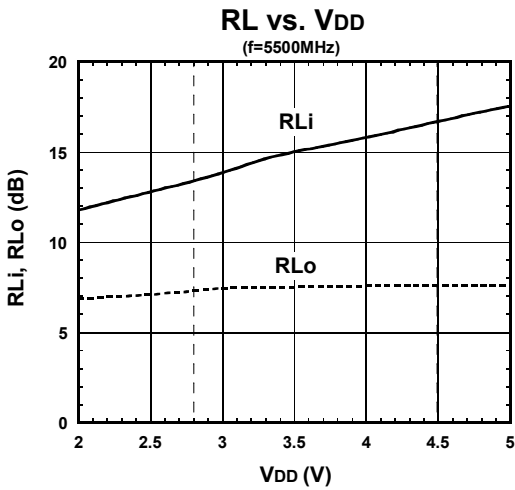
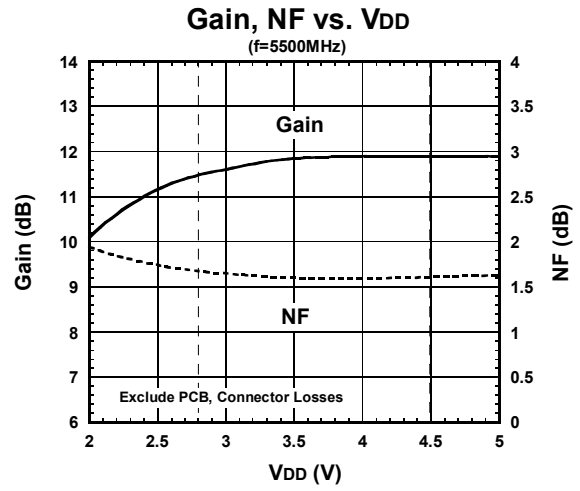
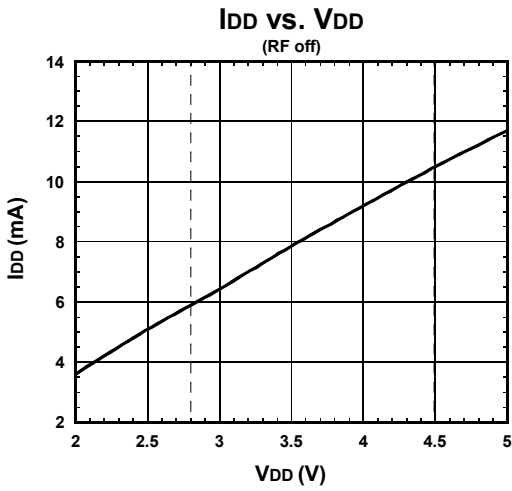

■ ELECTRICAL CHARACTERISTICS (LNA mode)

Conditions: $V_{DD}=3.3V$, $V_{CTL}=1.8V$, $Z_s=Z_l=50\Omega$, with application circuit

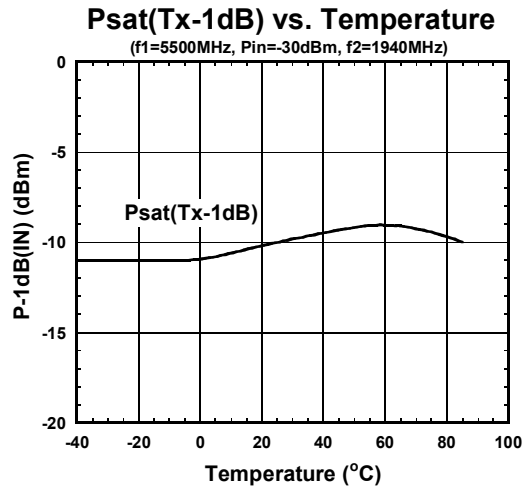
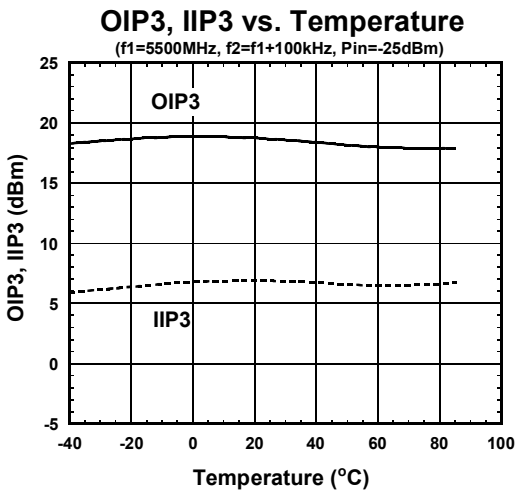
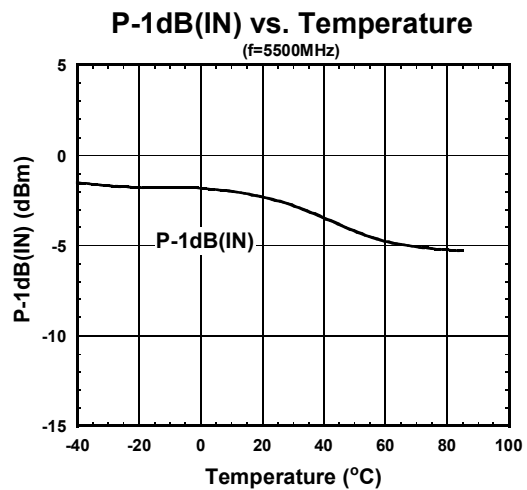
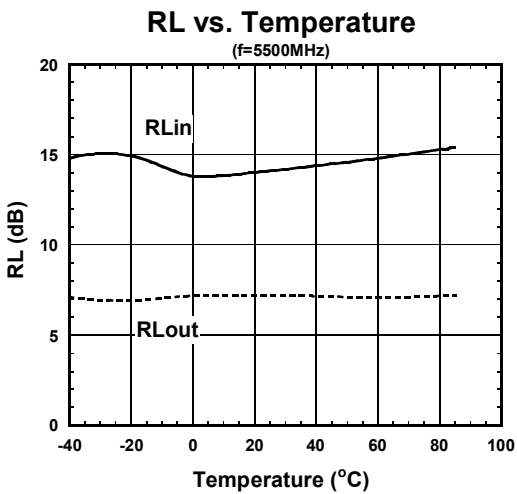
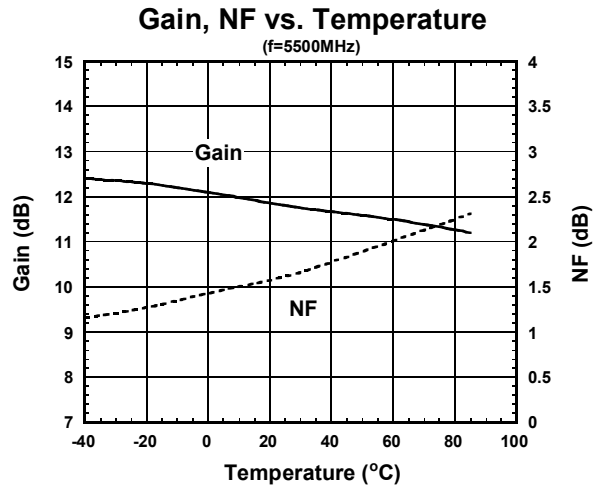
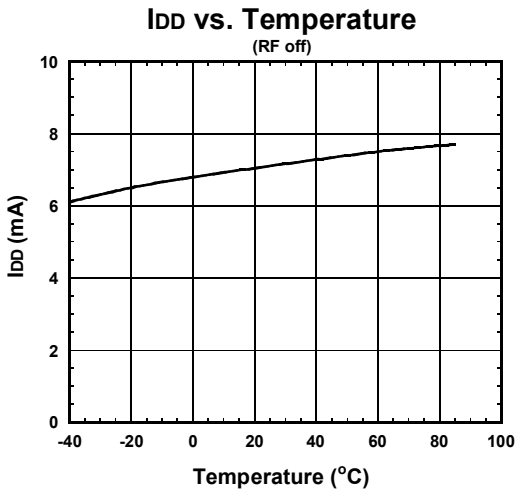

■ ELECTRICAL CHARACTERISTICS (LNA mode)

Conditions: $V_{DD}=3.3V$, $V_{CTL}=1.8V$, $Z_s=Z_l=50\Omega$, with application circuit

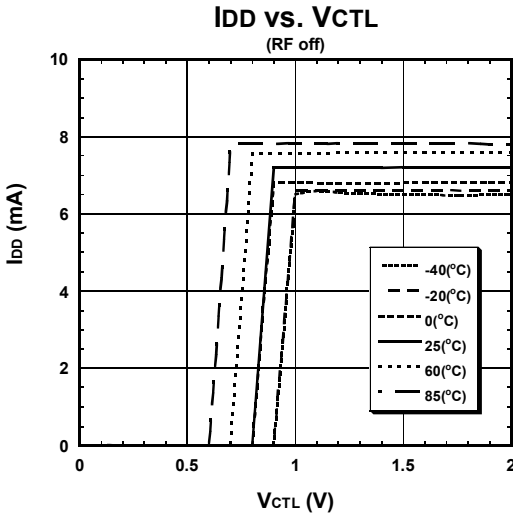
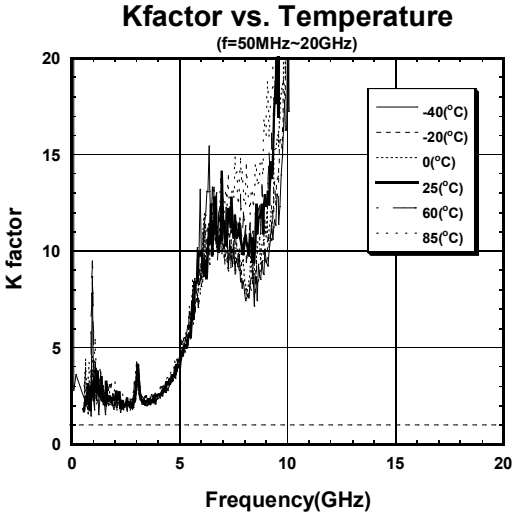

ELECTRICAL CHARACTERISTICS (Bypass mode)

Conditions: $V_{DD}=3.3V$, $V_{CTL}=0V$, $T_a=25^{\circ}C$, $Z_s=Z_L=50\Omega$, with application circuit

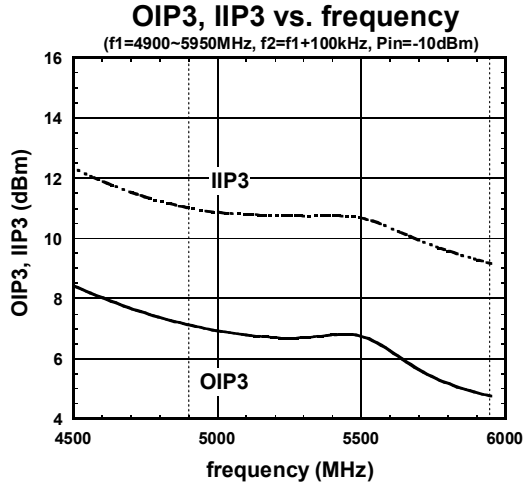
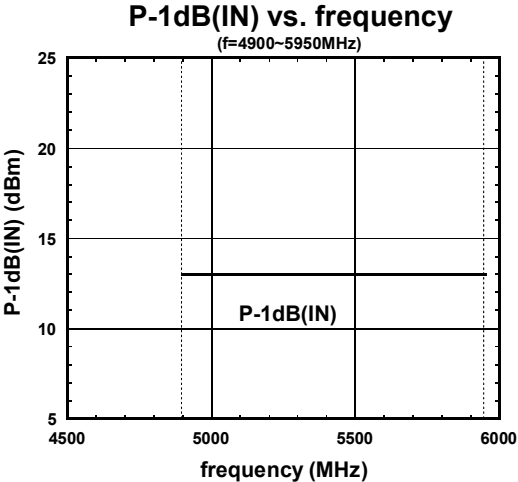
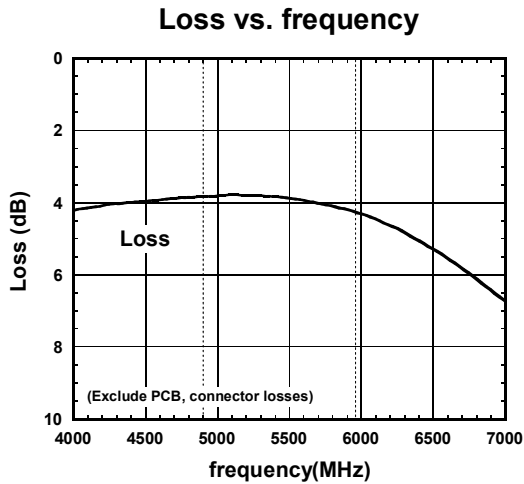
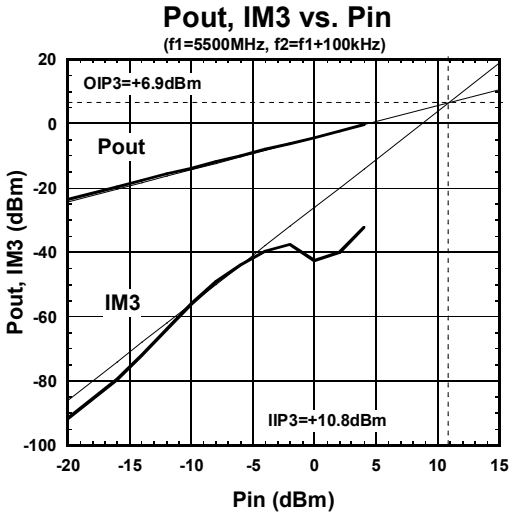
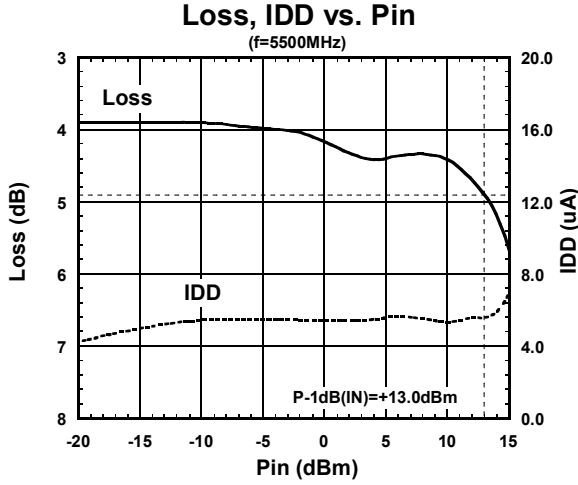
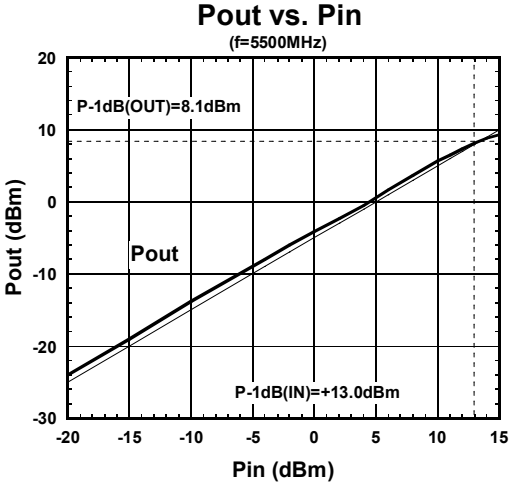

■ ELECTRICAL CHARACTERISTICS (Bypass mode)

Conditions: $V_{DD}=3.3V$, $V_{CTL}=0V$, $T_a=25^\circ C$, $Z_s=Z_l=50\Omega$, with application circuit

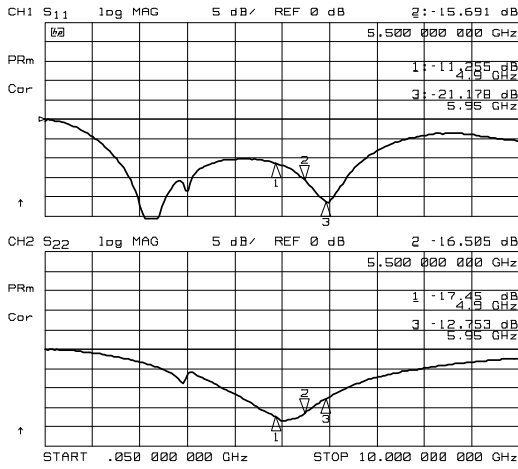

S11, S22 (0.05~10GHz)

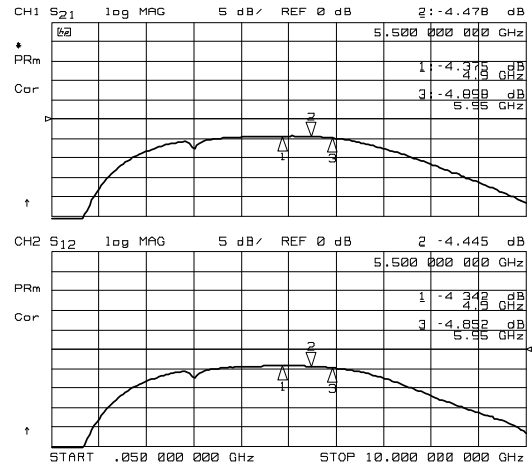

S21, S12 (0.05~10GHz)

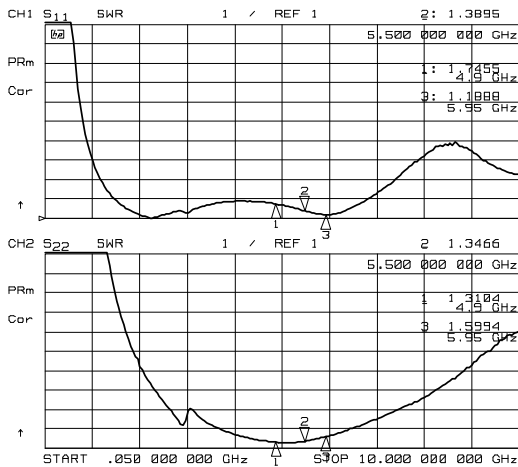

VSWRi, VSWRo (0.05~10GHz)

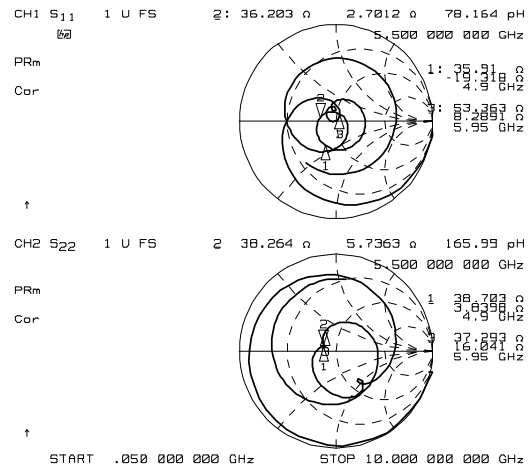

Zin, Zout (0.05~10GHz)

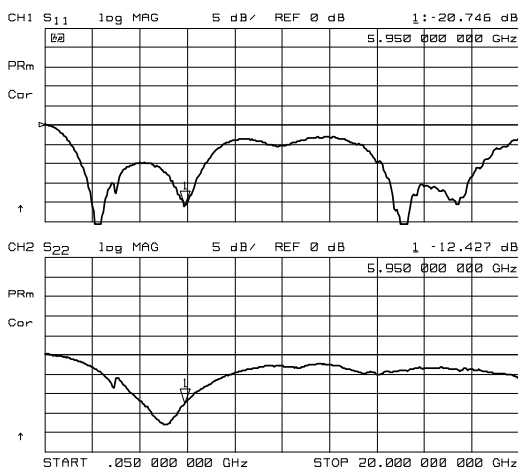

S11, S22 (0.05~20GHz)

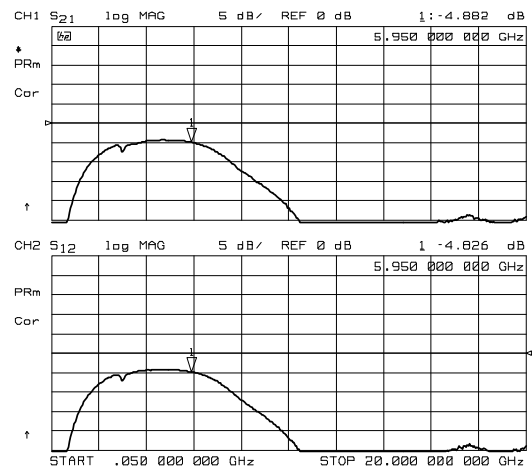

S21, S12 (0.05~20GHz)

■ ELECTRICAL CHARACTERISTICS (Bypass mode)

Conditions: $V_{CTL}=0V$, $T_a=25^\circ C$, $Z_s=Z_L=50\Omega$, with application circuit

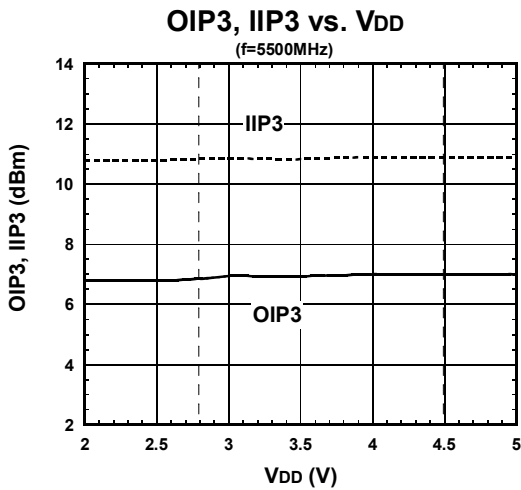
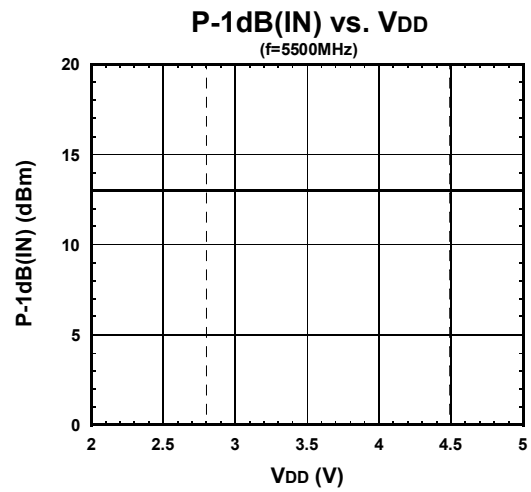
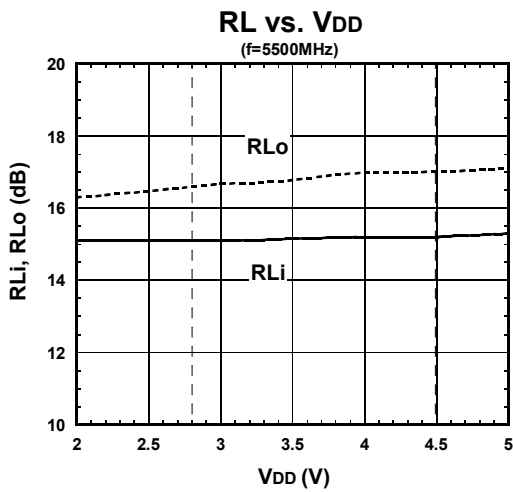
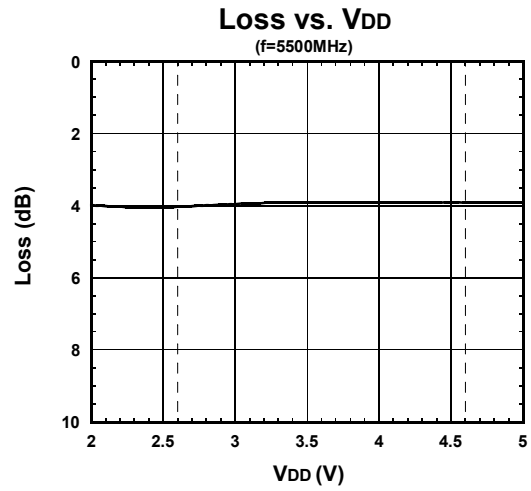
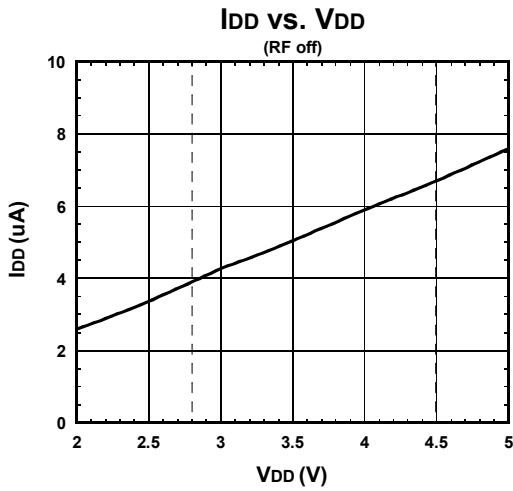

■ ELECTRICAL CHARACTERISTICS (Bypass mode)

Conditions: $V_{DD}=3.3V$, $V_{CTL}=1.8V$, $Z_s=Z_l=50\Omega$, with application circuit

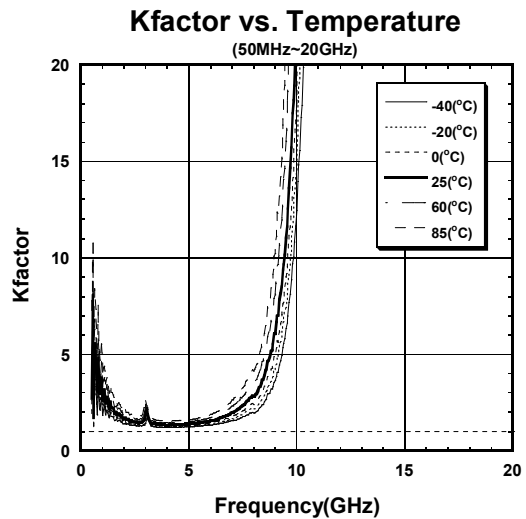
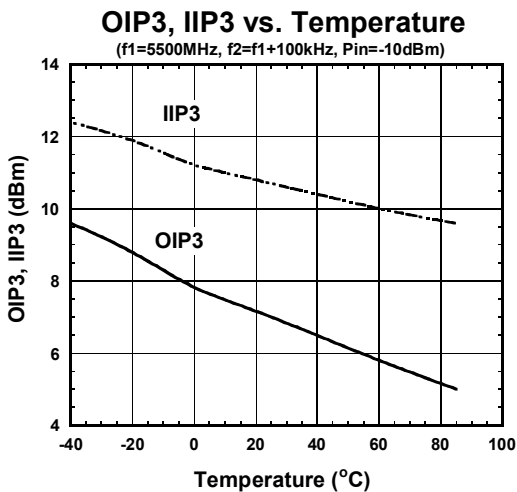
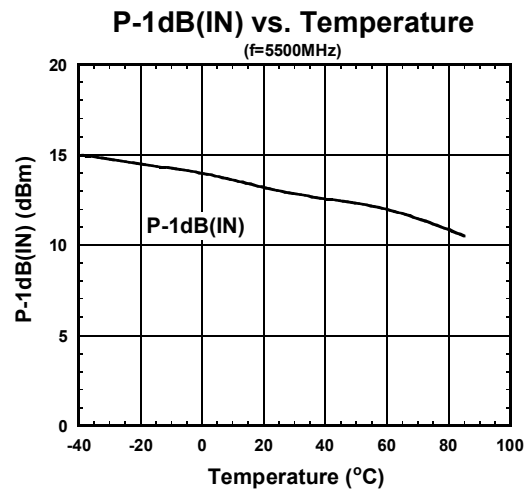
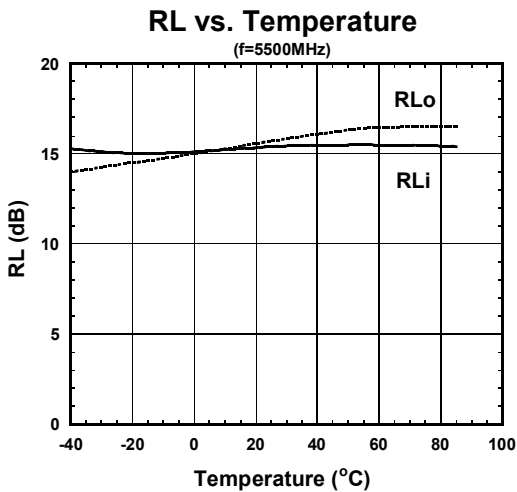
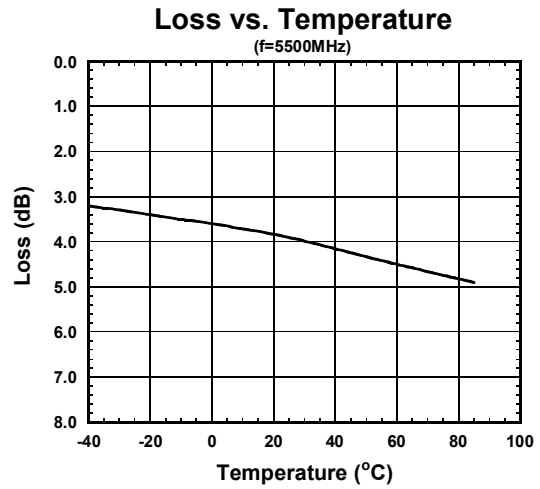
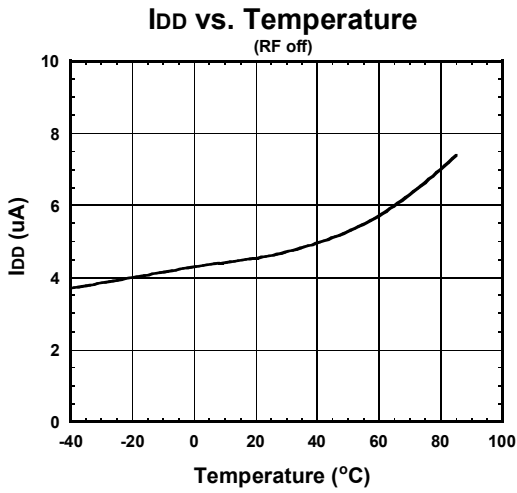

APPLICATION CIRCUIT

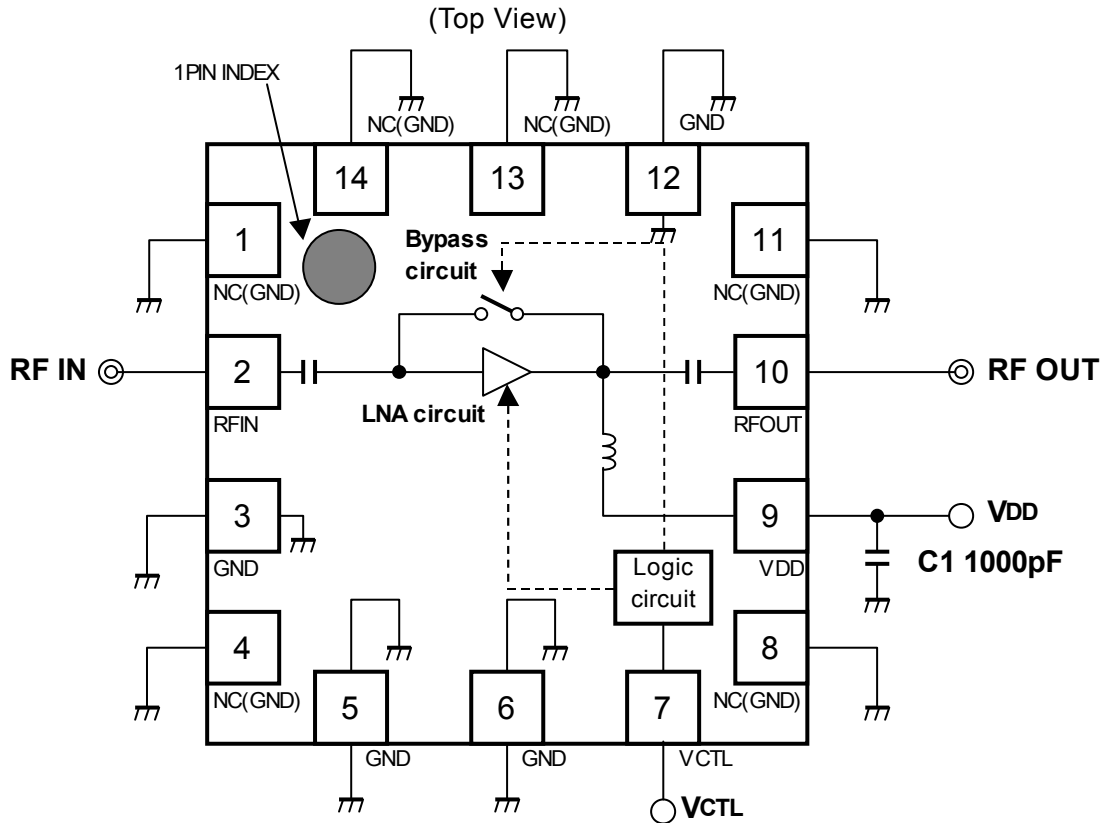

TEST PCB LAYOUT

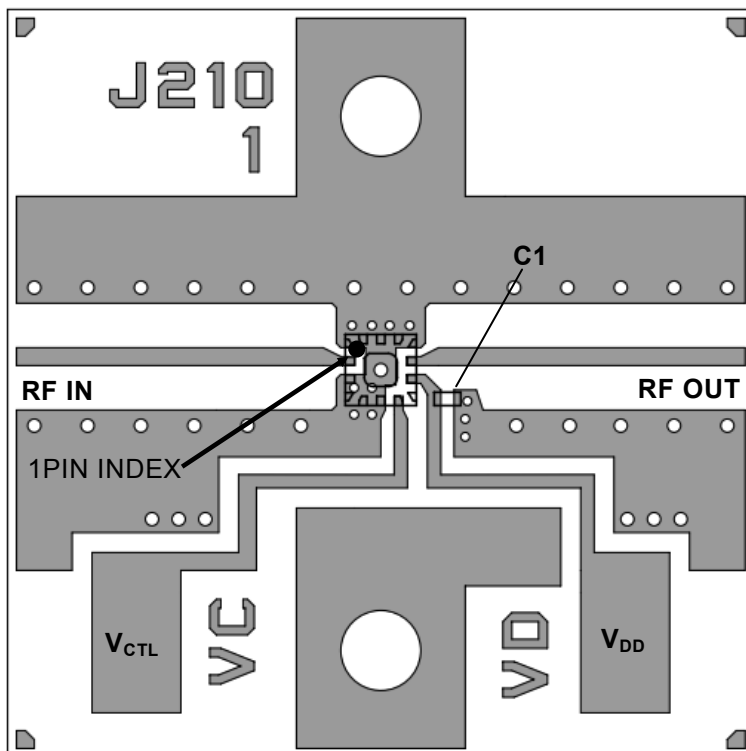

PARTS LIST

Parts ID	Manufacturer
C1	MURATA GRM03 Series

PCB

Substrate: FR4

Thickness: 0.2mm

MICROSTRIP LINE WIDTH
: 0.40mm ($Z_0=50\Omega$)

PCB SIZE: 17.0mm x 17.0mm

PRECAUTIONS

- Bypass capacitor C1 is placed as close as possible to the IC.
- In order not to couple with terminal RF IN and RF OUT, please layout ground pattern under the IC.
- All GND terminals must be connected to PCB ground place in order to reduce the inductance as soon as possible.

MEASUREMENT BLOCK DIAGRAM

Measuring instruments

NF Analyzer : Agilent 8975A
Noise Source : Agilent 346A

Setting the NF analyzer

Measurement mode form
Device under test : Amplifier
System downconverter : off
Mode setup form
Sideband : LSB
Averages : 16
Average mode : Point
Bandwidth : 4MHz
Loss comp : off
Tcold : setting the temperature of noise source (300K)

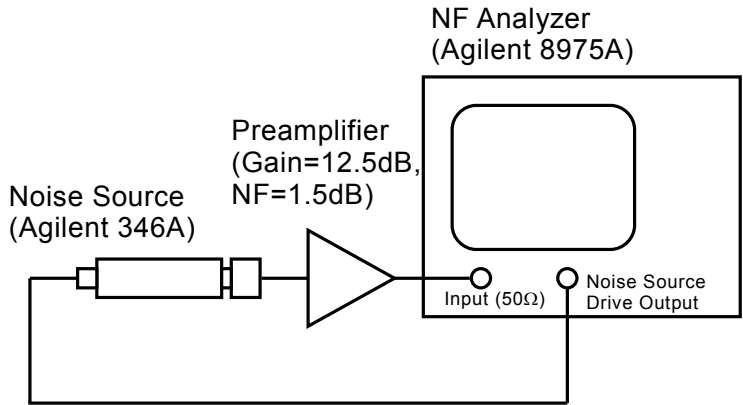

Calibration Setup

* Noise sauce, the preamplifier, and NF analyzer are connected directly.

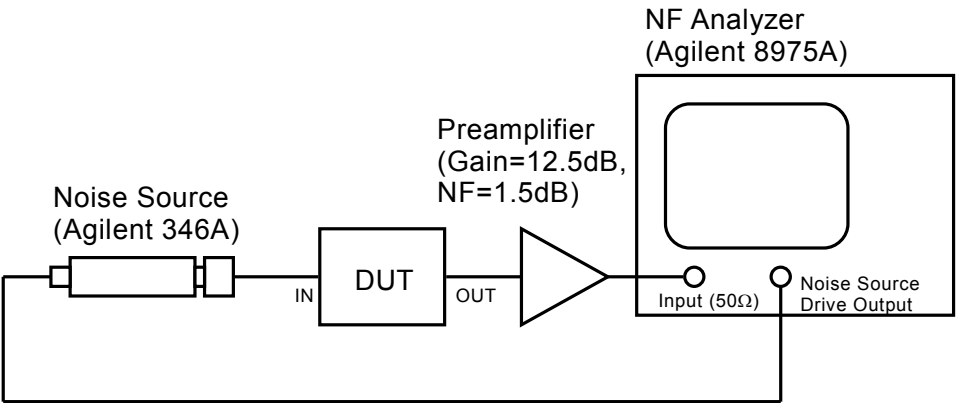

Measurement Setup

* Noise sauce, DUT, the preamplifier, and NF analyzer are connected directly.

PACKAGE OUTLINE (ESON14-D7)

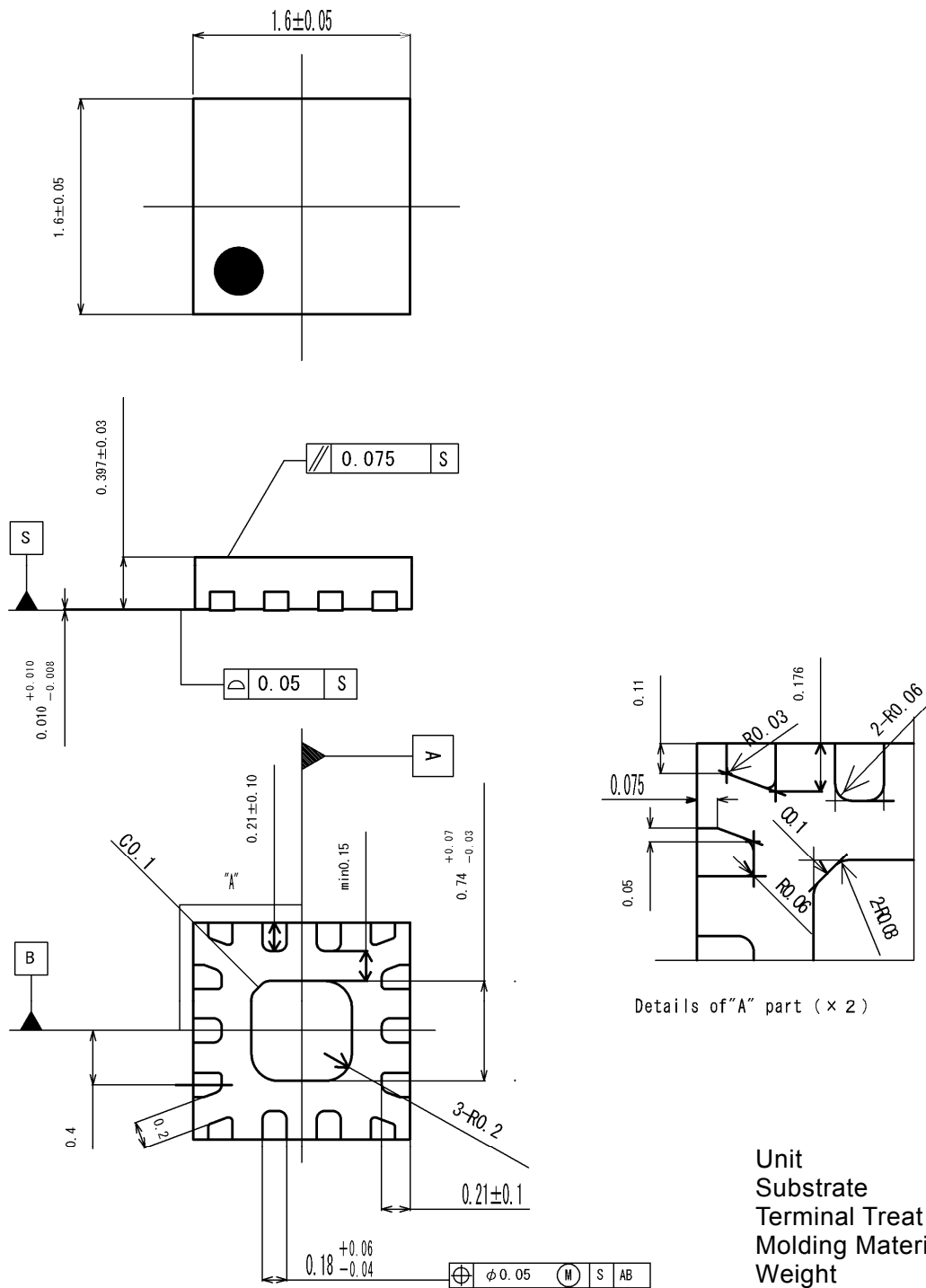

Cautions on using this product

- This product contains Gallium-Arsenide (GaAs) which is a harmful material.
- Do NOT eat or put into mouth.
 - Do NOT dispose in fire or break up this product.
 - Do NOT chemically make gas or powder with this product.
 - To waste this product, please obey the relating law of your country.

[CAUTION]

The specifications on this databook are only given for information, without any guarantee as regards either mistakes or omissions. The application circuits in this databook are described only to show representative usages of the product and not intended for the guarantee or permission of any right including the industrial rights.

This product may be damaged with electric static discharge (ESD) or spike voltage. Please handle with care to avoid these damages.