

## Wide Band Low Noise Amplifier GaAs MMIC

### ■ GENERAL DESCRIPTION

The NJG1162K64 is a fully matched wide band low noise amplifier GaAs MMIC for digital TV applications.

To achieve wide dynamic range, the NJG1162K64 offers LNA mode and bypass mode. Selecting LNA mode for weak signals, the NJG1162K64 helps improve receiver sensitivity through high gain and low noise figure.

The ultra small and ultra thin DFN8-64 package is adopted.

### ■ PACKAGE OUTLINE

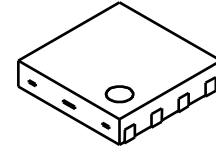

NJG1162K64

### ■ APPLICATION

- Terrestrial application like Digital TV
- Set-top box

### ■ FEATURES

- Operating frequency 40 to 1000MHz
- Package DFN8-64 (Package size: 1.5 x 1.5 x 0.375mm)
- RoHS compliant and Halogen free, MSL1

[ LNA mode ]

- Operating current 50mA typ.
- Small signal gain 13.0dB typ.
- Noise figure 2.5dB typ. @f=40 to 80MHz  
2.2dB typ. @f=80 to 1000MHz

[ Bypass mode ]

- Insertion loss 1.0dB typ.

### ■ PIN CONFIGURATION

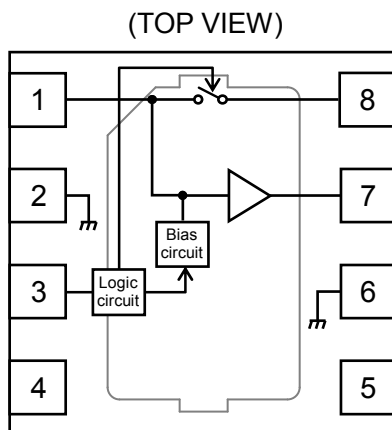

1. RFIN
  2. GND
  3. VCTL
  4. NC (GND)
  5. NC (GND)
  6. GND
  7. RFOUT1
  8. RFOUT2
- Exposed pad: GND

### ■ TRUTH TABLE "H"= $V_{CTL}(H)$ , "L"= $V_{CTL}(L)$

$V_{CTL}$	LNA	Bypass	Mode select
H	ON	OFF	LNA mode
L	OFF	ON	Bypass mode

Note: Specifications and description listed in this datasheet are subject to change without notice.

## ■ ABSOLUTE MAXIMUM RATINGS

$T_a=+25^{\circ}\text{C}$ ,  $Z_s=Z_l=50\Omega$

PARAMETER	SYMBOL	CONDITIONS	RATINGS	UNITS
Supply voltage	$V_{DD}$		5.5	V
Control voltage	$V_{CTL}$		5.5	V
Input power	$P_{IN}$	$V_{DD}=3.3\text{V}$	+10	dBm
Power dissipation	$P_D$	Four-layer FR4 PCB with through holes (76.2 x 114.3mm), $T_j=150^{\circ}\text{C}$	520	mW
Operating temperature	$T_{opr}$		-40 to +85	$^{\circ}\text{C}$
Storage temperature	$T_{stg}$		-55 to +150	$^{\circ}\text{C}$

## ■ ELECTRICAL CHARACTERISTICS1 (DC CHARACTERISTICS)

$V_{DD}=3.3\text{V}$ ,  $T_a=+25^{\circ}\text{C}$ , with application circuit

PARAMETERS	SYMBOL	CONDITIONS	MIN	TYP	MAX	UNITS
Supply voltage	$V_{DD}$		2.4	3.3	5.0	V
Control voltage (High)	$V_{CTL(H)}$		1.4	1.8	5.0	V
Control voltage (Low)	$V_{CTL(L)}$		0.0	0.0	0.4	V
Operating current1	$I_{DD1}$	RF OFF, $V_{CTL}=1.8\text{V}$	-	50	70	mA
Operating current2	$I_{DD2}$	RF OFF, $V_{CTL}=0\text{V}$	-	20	40	$\mu\text{A}$
Control current	$I_{CTL}$	RF OFF, $V_{CTL}=1.8\text{V}$	-	6	12	$\mu\text{A}$

## ■ ELECTRICAL CHARACTERISTICS2 (RF CHARACTERISTICS: LNA mode)

$V_{DD}=3.3V$ ,  $V_{CTL}=1.8V$ , freq=40 to 1000MHz,  $T_a=+25^{\circ}C$ ,  $Z_s=Z_l=50\Omega$ , with application circuit

PARAMETERS	SYMBOL	CONDITIONS	MIN	TYP	MAX	UNITS
Small signal gain1	Gain1	Exclude PCB and connector losses *1	10.0	13.0	15.0	dB
Noise figure1_1	NF1_1	freq=40 to 80MHz, Exclude PCB and connector losses *2	-	2.5	4.0	dB
Noise figure1_2	NF1_2	freq=80 to 1000MHz, Exclude PCB and connector losses *2	-	2.2	3.0	dB
Input power 1dB compression1	P-1dB(IN)1		-1.0	+4.0	-	dBm
Input 3rd order intercept point1	IIP3_1	f1=freq, f2=freq+100kHz, $P_{IN}=-12dBm$	+12.0	+20.0	-	dBm
2nd order intermodulation distortion1	IM2_1	f1=200MHz, f2=500MHz, fmeas=700MHz, $P_{IN1}=P_{IN2}=-15dBm$	42.0	47.0	-	dB
3rd order intermodulation distortion1	IM3_1	f1=600MHz, f2=650MHz, fmeas=700MHz, $P_{IN1}=P_{IN2}=-15dBm$	47.0	66.0	-	dB
RFIN Port return loss1	RLi1		7	12	-	dB
RFOUT Port return loss1	RLo1		7	12	-	dB

\*1 Input and output PCB, connector losses: 0.014dB(40MHz), 0.088dB(620MHz), 0.132dB(1000MHz)

\*2 Input PCB, connector losses: 0.007dB(40MHz), 0.011dB(80MHz), 0.044dB(620MHz), 0.066dB(1000MHz)

## ■ ELECTRICAL CHARACTERISTICS3 (RF CHARACTERISTICS: Bypass mode)

$V_{DD}=3.3V$ ,  $V_{CTL}=0V$ , freq=40 to 1000MHz,  $T_a=+25^{\circ}C$ ,  $Z_s=Z_l=50\Omega$ , with application circuit

PARAMETERS	SYMBOL	CONDITIONS	MIN	TYP	MAX	UNITS
Insertion loss2	LOSS2	Exclude PCB and connector losses *1	-	1.0	2.5	dB
Input power 1dB compression2	P-1dB(IN)2		+9.0	+16.0	-	dBm
Input 3rd order intercept point2	IIP3_2	f1=freq, f2=freq+100kHz, $P_{IN}=-2dBm$	+19.0	+33.0	-	dBm
RFIN Port return loss2	RLi2		8	15	-	dB
RFOUT Port return loss2	RLo2		7	15	-	dB

\*1 Input and output PCB, connector losses: 0.014dB(40MHz), 0.088dB(620MHz), 0.132dB(1000MHz)

## ■ TERMINAL INFORMATION

No.	SYMBOL	DESCRIPTION
1	RFIN	RF input terminal. External capacitor C1 is required to block the DC bias voltage of internal circuit.
2	GND	Ground terminal. This terminal should be connected to the ground plane as close as possible for excellent RF performance.
3	VCTL	Control voltage terminal. At this terminal, the switching of the LNA mode and Bypass mode is possible.
4	NC(GND)	No connected terminal. This terminal is not connected with internal circuit. Connect to the PCB ground plane.
5	NC(GND)	No connected terminal. This terminal is not connected with internal circuit. Connect to the PCB ground plane.
6	GND	Ground terminal. This terminal should be connected to the ground plane as close as possible for excellent RF performance.
7	RFOUT1	The RF output terminal of the LNA mode. This terminal doubles as the drain terminal of the LNA. Please connect this terminal to the power supply via choke inductor.
8	RFOUT2	The RF output terminal of the Bypass mode. Please connect this terminal with RFOUT1 terminal through DC blocking capacitor shown in the application circuit.
Exposed Pad	GND	Ground terminal. Connect exposed pad to ground plane as close as possible for excellent RF performance.

## ■ ELECTRICAL CHARACTERISTICS (LNA mode, 50Ω)

Conditions:  $V_{DD}=3.3V$ ,  $V_{CTL}=1.8V$ ,  $T_a=25^\circ C$ ,  $Z_s=Z_L=50\Omega$ , with application circuit

### NF, Gain vs. Frequency

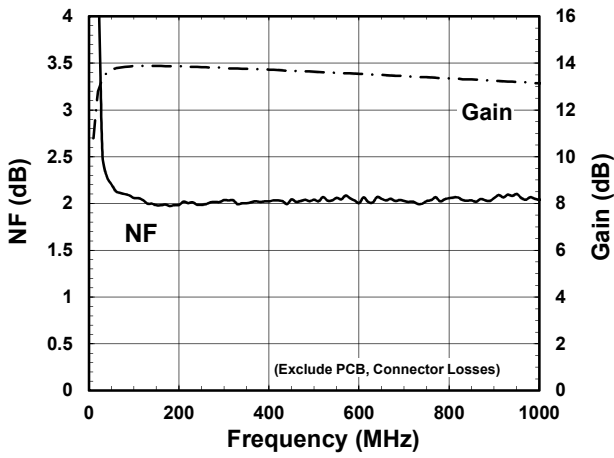

### Gain, IDD vs. Pin

(f=620MHz)

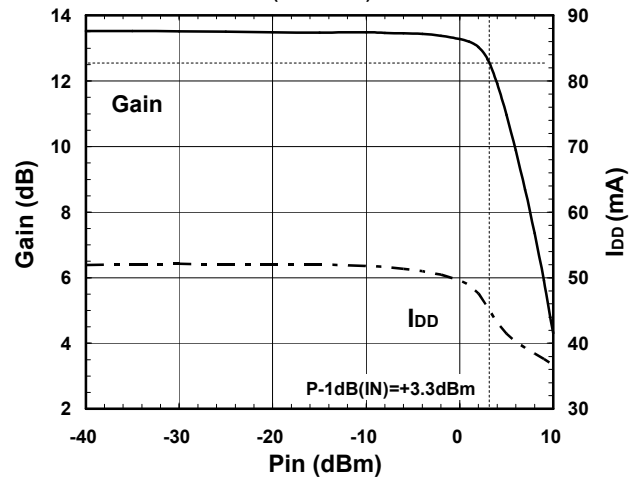

### Pout vs. Pin

(f=620MHz)

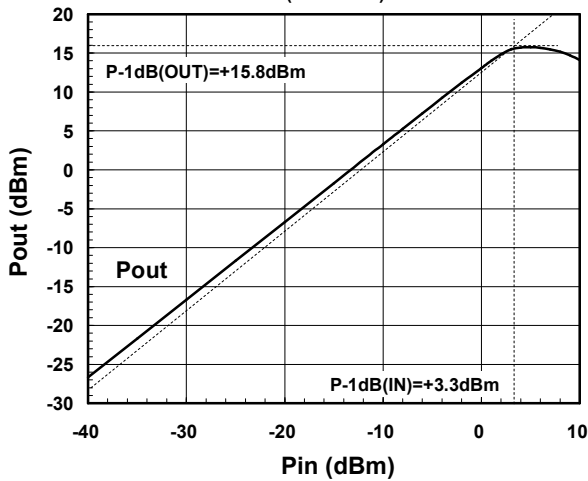

### P-1dB(IN) vs. Frequency

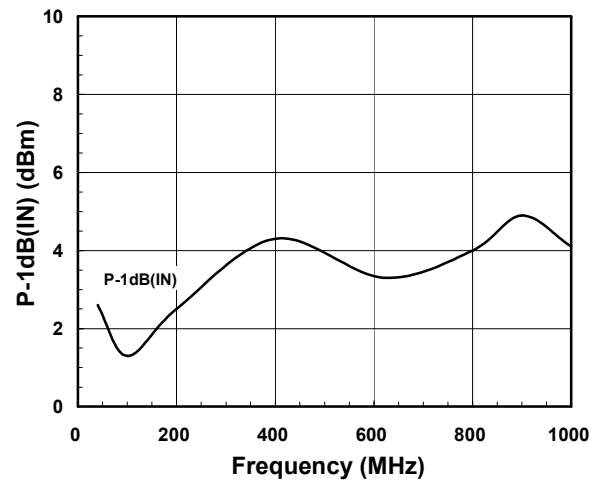

### Pout, IM3 vs. Pin

(f1=620MHz, f2=620.1MHz)

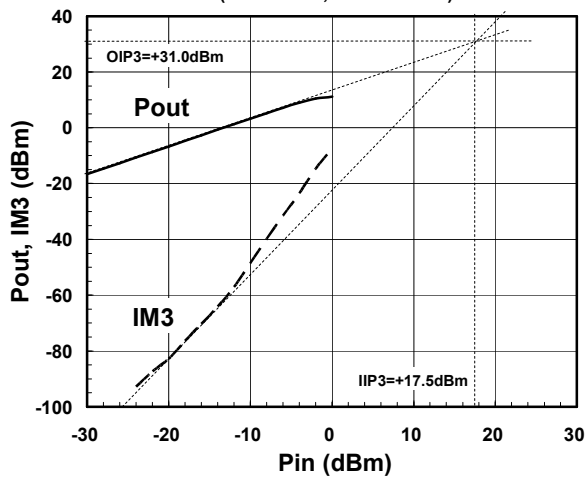

### IIP3, OIP3 vs. Frequency

(f1=Frequency, f2=f1+100kHz, Pin=-14dBm)

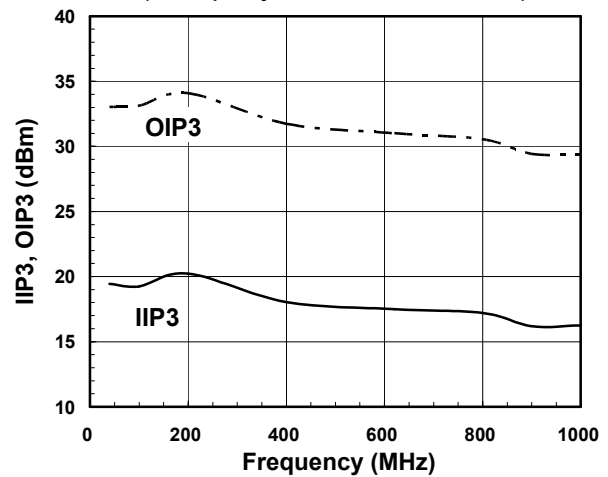

## ELECTRICAL CHARACTERISTICS (LNA mode, 50Ω)

Conditions:  $V_{DD}=3.3V$ ,  $V_{CTL}=1.8V$ ,  $T_a=25^\circ C$ ,  $Z_s=Z_l=50\Omega$ , with application circuit

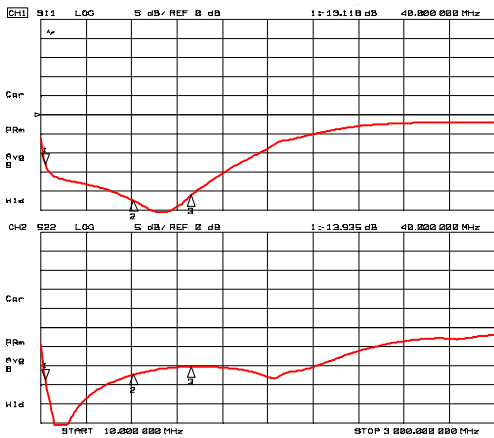

S11, S22 (f=10MHz to 3GHz)

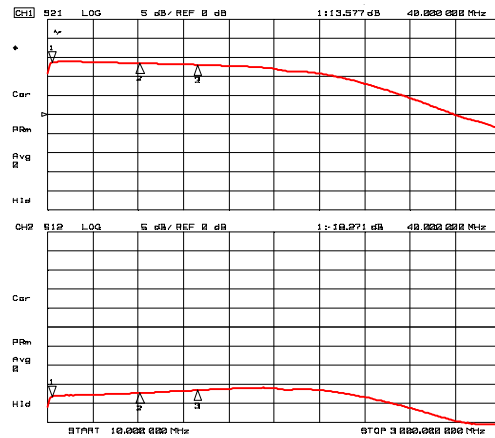

S21, S12 (f=10MHz to 3GHz)

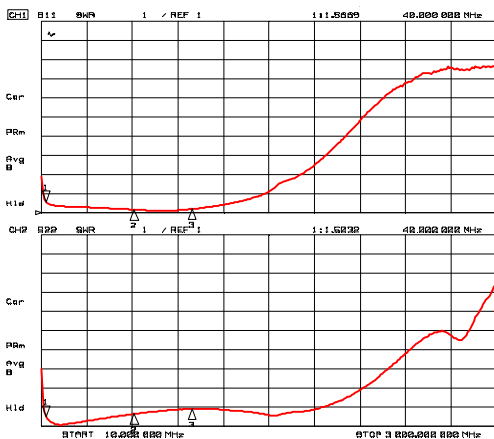

VSWR<sub>i</sub>, VSWR<sub>o</sub> (f=10MHz to 3GHz)

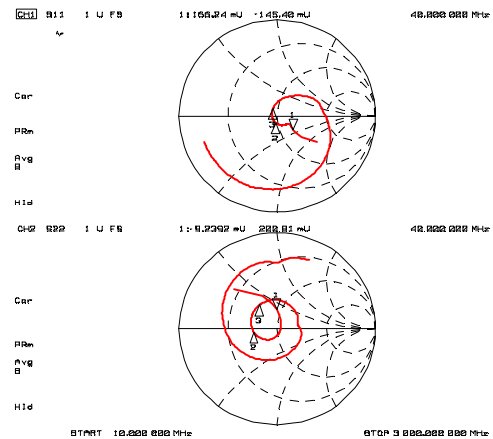

Z<sub>in</sub>, Z<sub>out</sub> (f=10MHz to 3GHz)

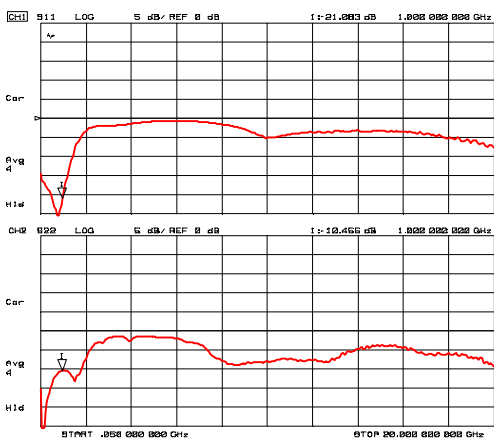

S11, S22 (f=50MHz to 20GHz)

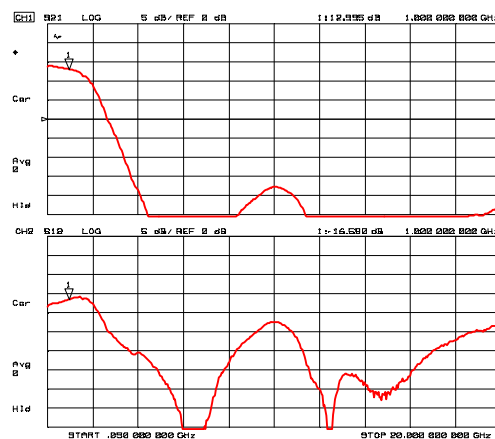

S21, S11 (f=50MHz to 20GHz)

## ■ ELECTRICAL CHARACTERISTICS (LNA mode, 50Ω)

Conditions:  $V_{DD}=3.3V$ ,  $V_{CTL}=1.8V$ ,  $T_a=25^{\circ}C$ ,  $Z_s=Z_l=50\Omega$ , with application circuit

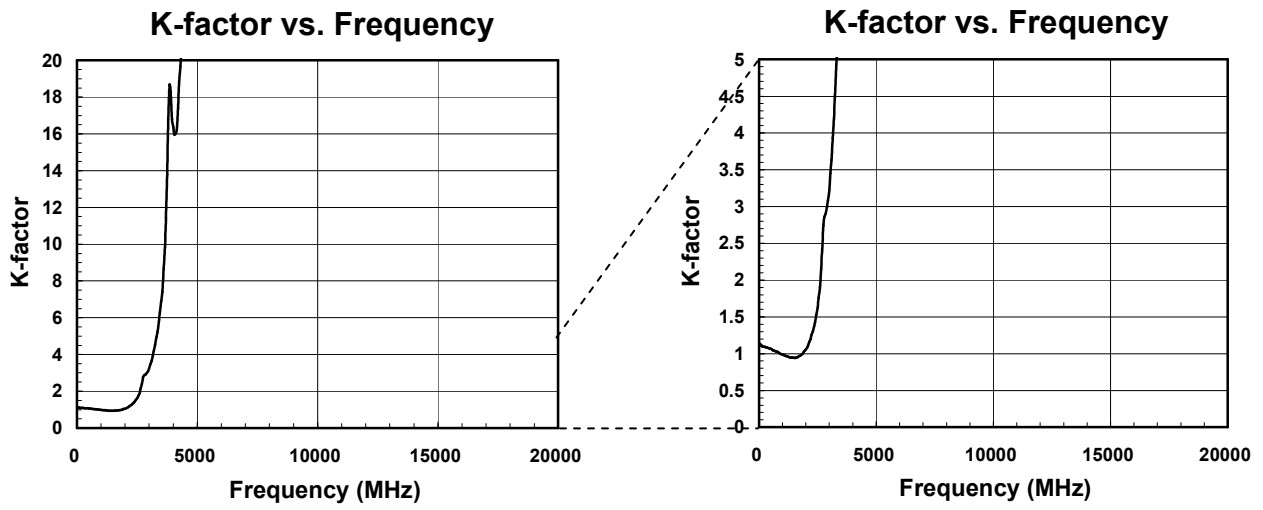

## ■ ELECTRICAL CHARACTERISTICS (LNA mode, 75Ω)

Conditions:  $V_{DD}=3.3V$ ,  $V_{CTL}=1.8V$ ,  $T_a=25^{\circ}C$ ,  $Z_s=Z_l=75\Omega$ , with application circuit

### RFIN Port Return Loss vs. Frequency

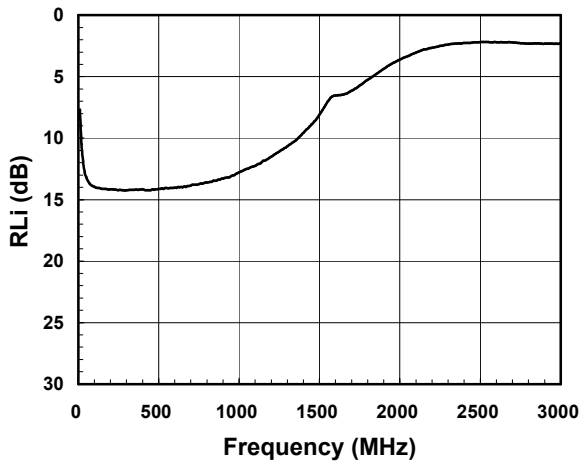

### RFOUT Port Return Loss vs. Frequency

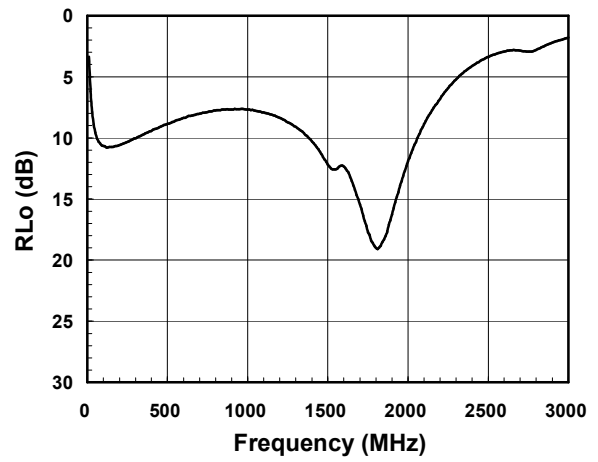

### Gain vs. Frequency

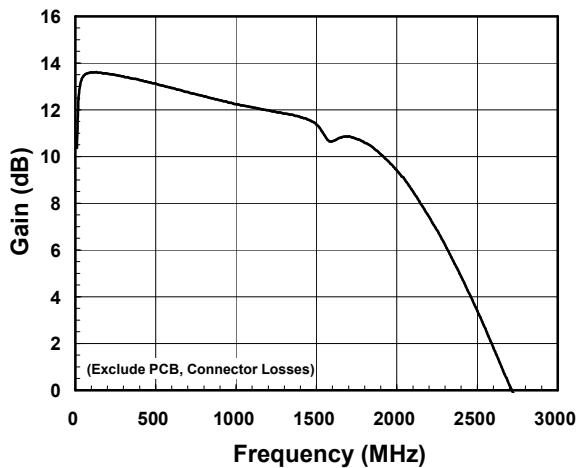



## ■ ELECTRICAL CHARACTERISTICS (LNA mode, 50Ω)

Conditions:  $V_{CTL}=1.8V$ ,  $T_a=25^{\circ}C$ ,  $Z_s=Z_l=50\Omega$ , with application circuit

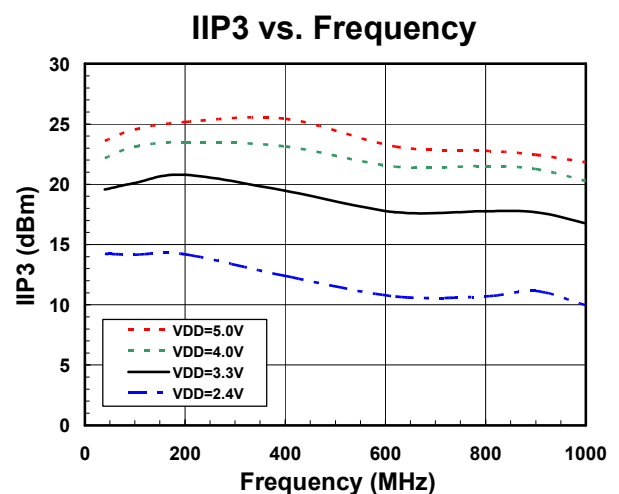
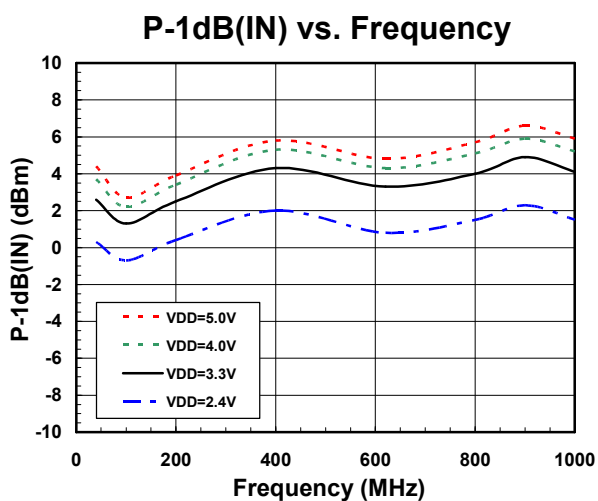
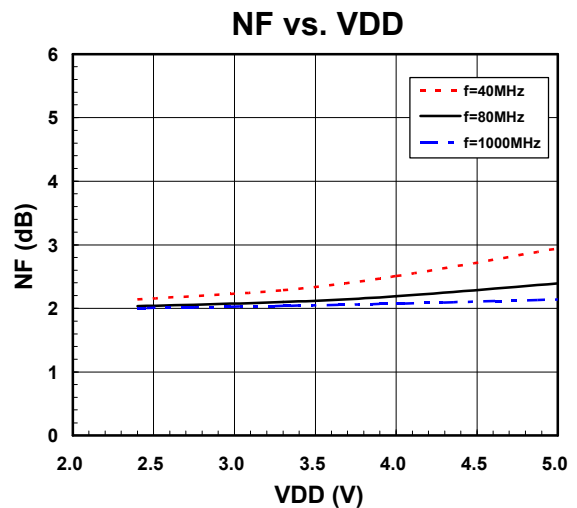
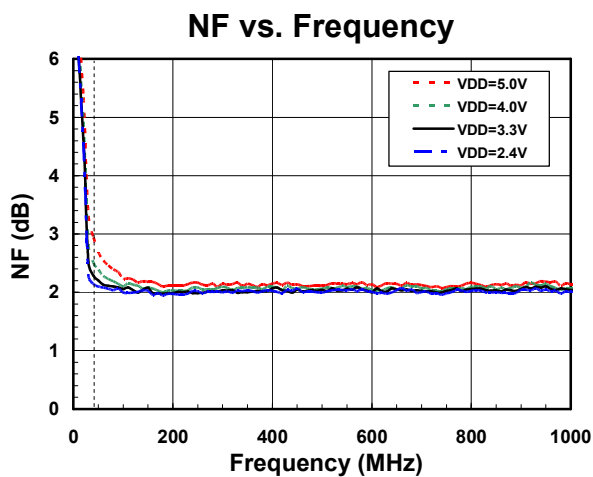
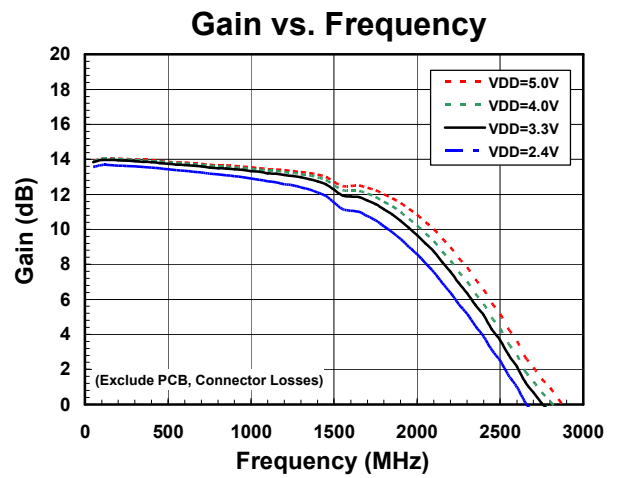
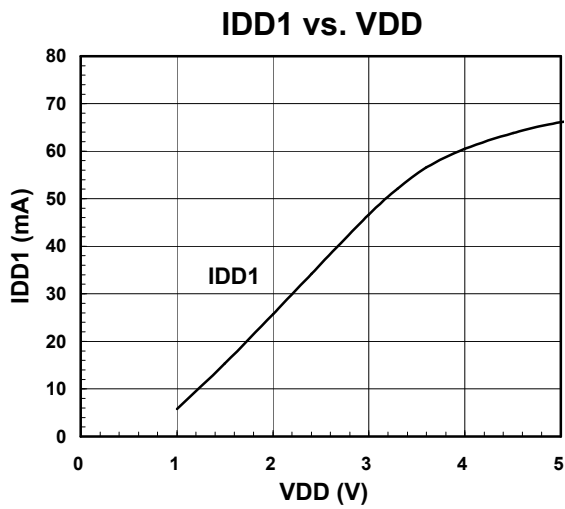

## ■ ELECTRICAL CHARACTERISTICS (LNA mode, 50Ω)

Conditions:  $V_{CTL}=1.8V$ ,  $T_a=25^{\circ}C$ ,  $Z_s=Z_l=50\Omega$ , with application circuit

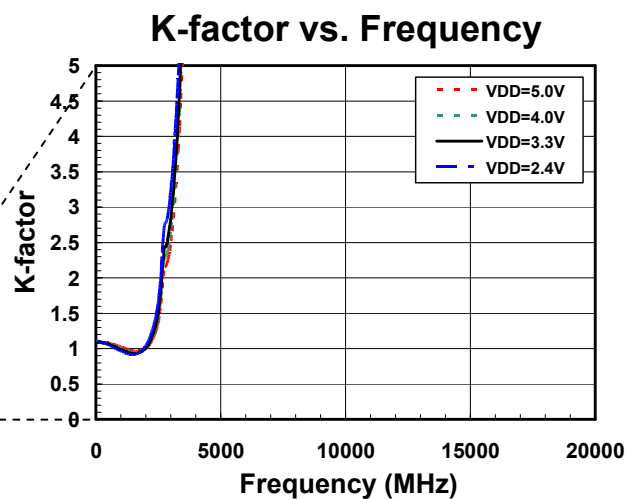
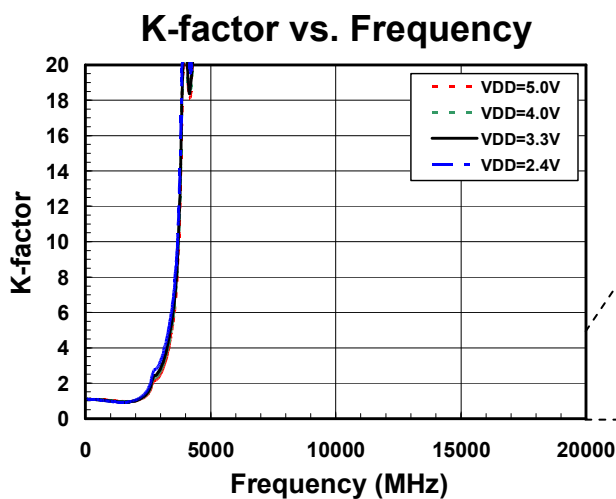
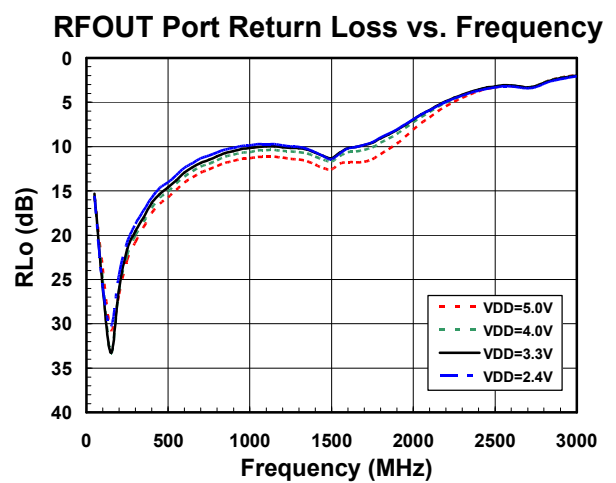
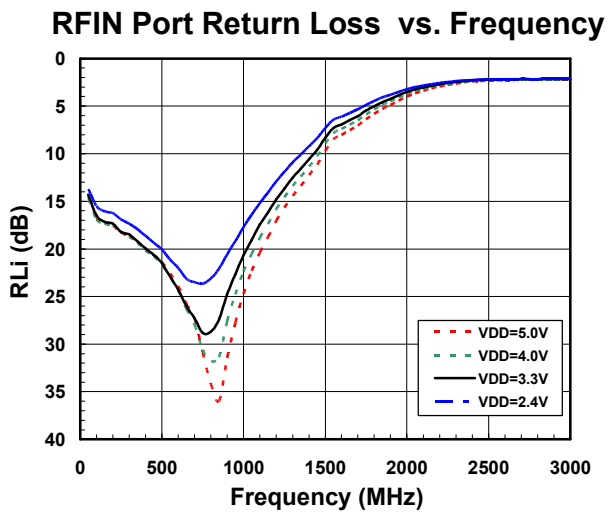
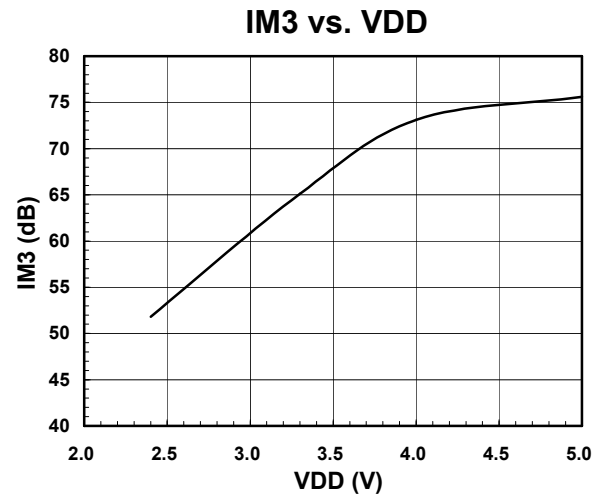
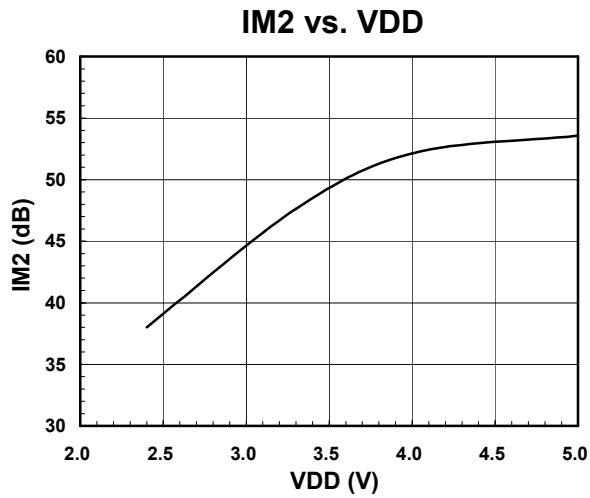

## ■ ELECTRICAL CHARACTERISTICS (LNA mode, 75Ω)

Conditions:  $V_{CTL}=1.8V$ ,  $T_a=25^{\circ}C$ ,  $Z_s=Z_L=75\Omega$ , with application circuit

### RFIN Port Return Loss vs. Frequency

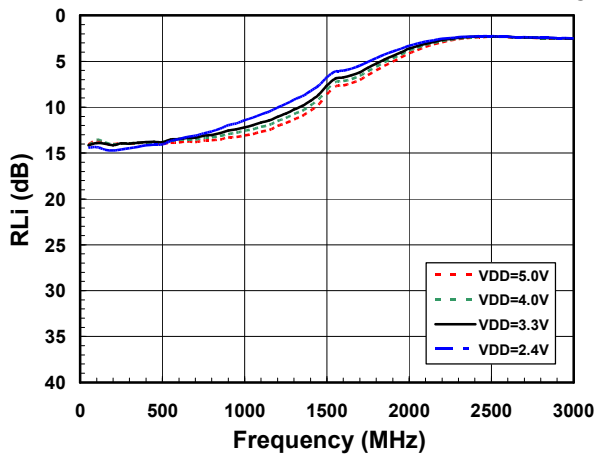

### RFOUT Port Return Loss vs. Frequency

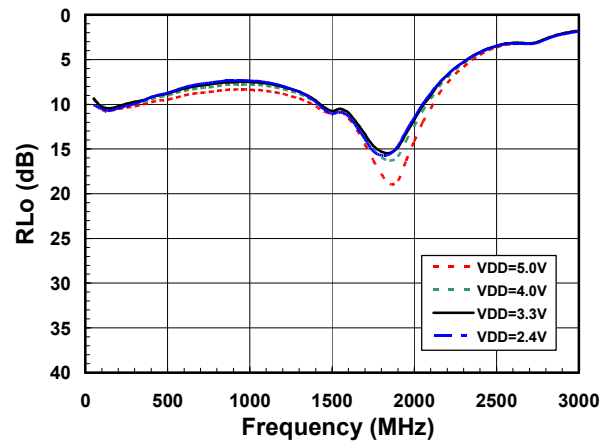

### Gain vs. Frequency

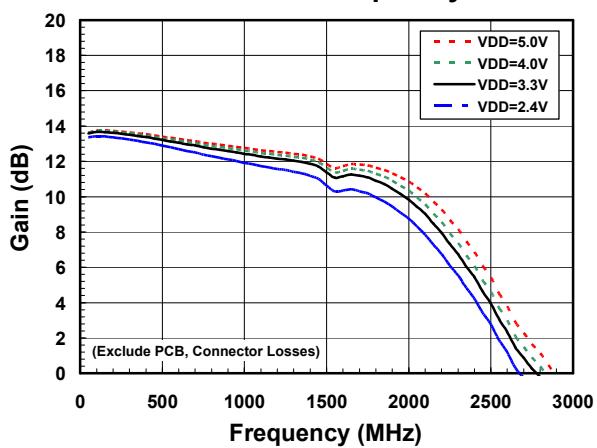

## ■ ELECTRICAL CHARACTERISTICS (LNA mode, 50Ω)

Conditions:  $V_{DD}=3.3V$ ,  $V_{CTL}=1.8V$ ,  $Z_s=Z_L=50\Omega$ , with application circuit

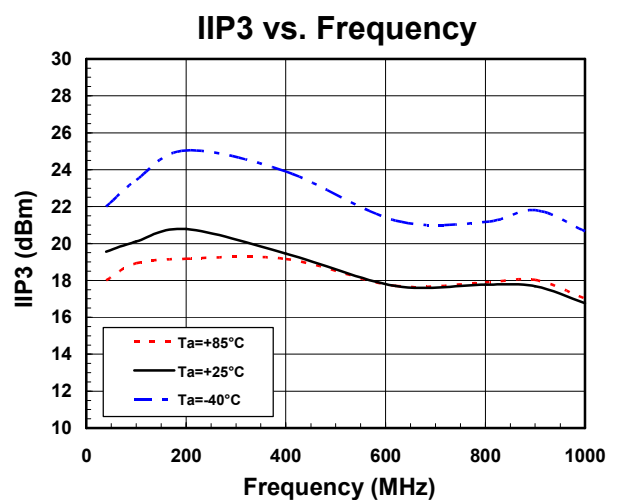
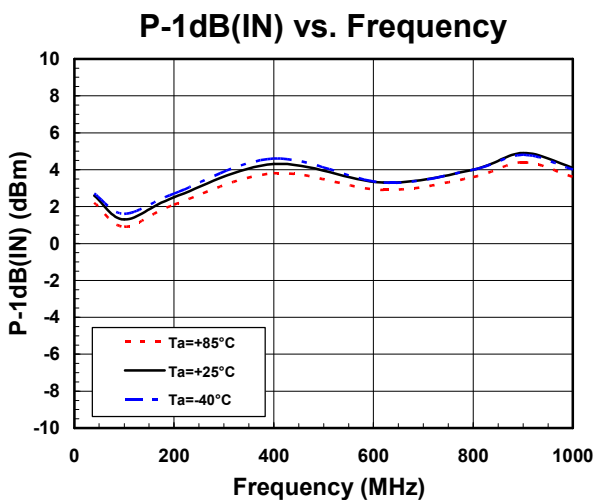
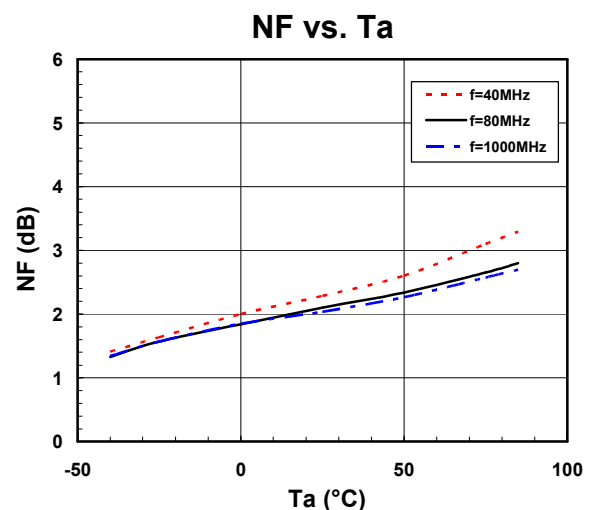
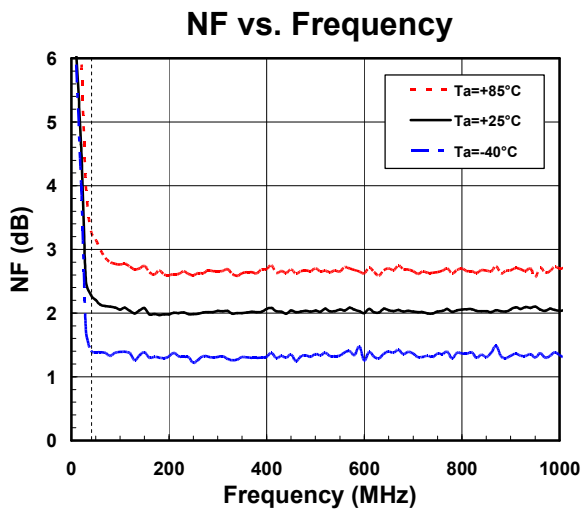
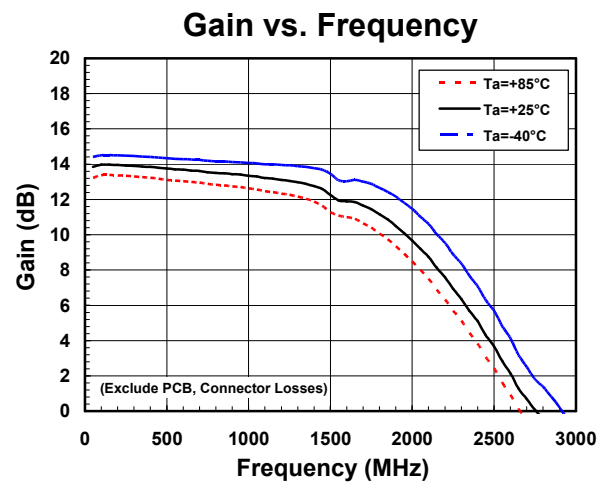
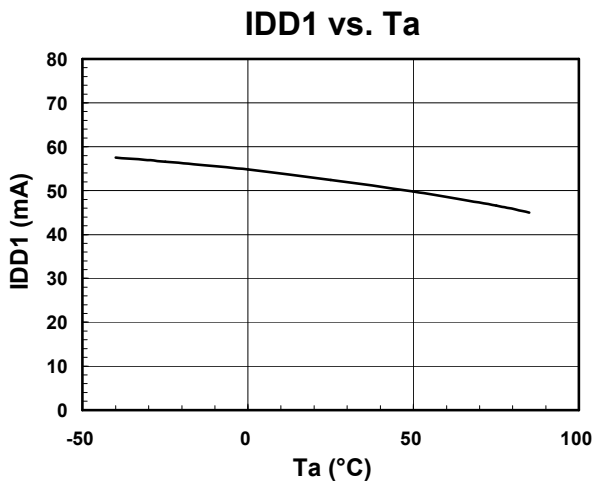

## ■ ELECTRICAL CHARACTERISTICS (LNA mode, 50Ω)

Conditions:  $V_{DD}=3.3V$ ,  $V_{CTL}=1.8V$ ,  $Z_s=Z_L=50\Omega$ , with application circuit

### IM2 vs. Ta

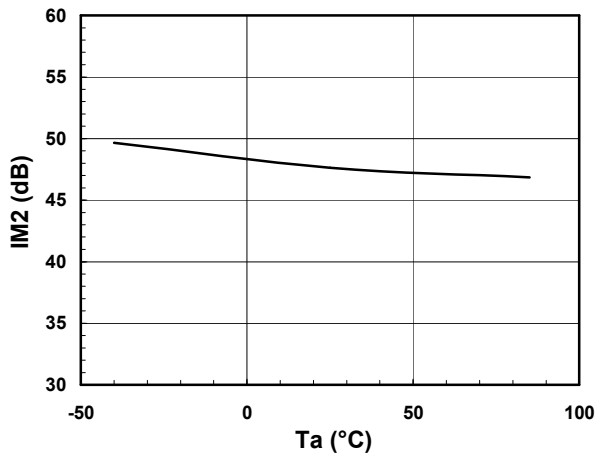

### IM3 vs. Ta

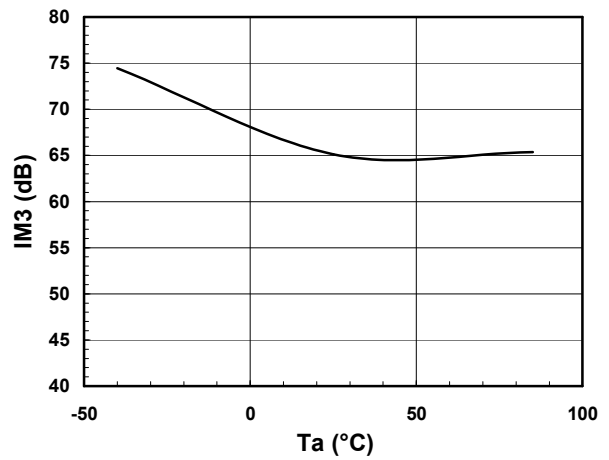

### RFIN Port Return Loss vs. Frequency

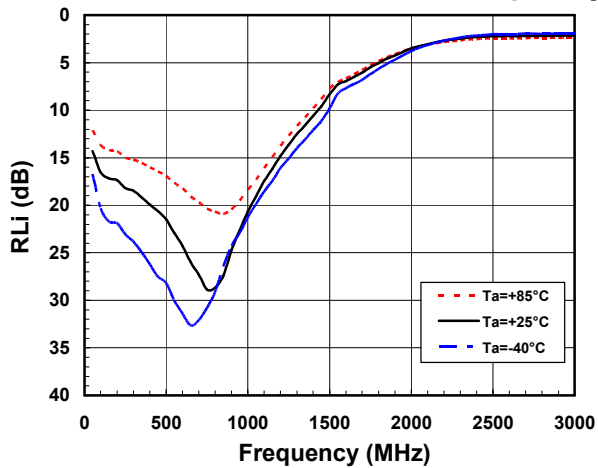

### RFOUT Port Return Loss vs. Frequency

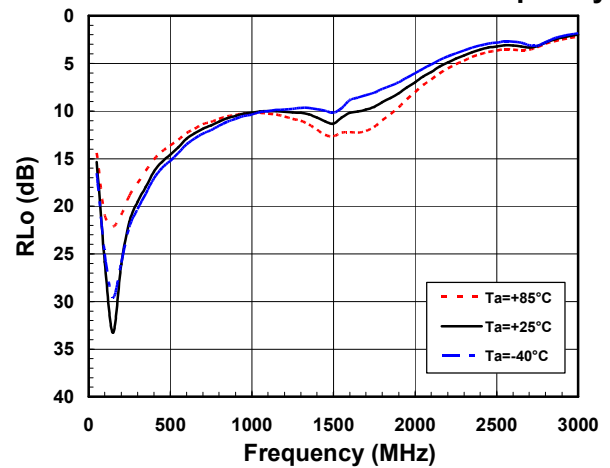

### K-factor vs. Frequency

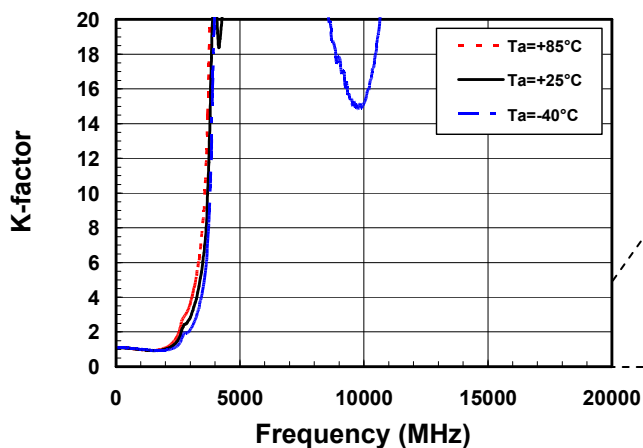

### K-factor vs. Frequency

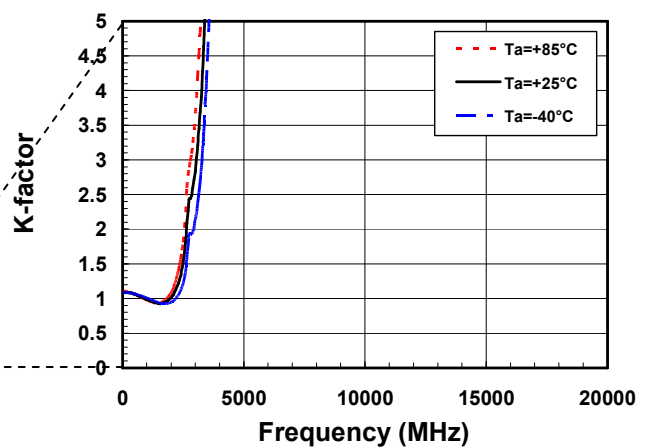

■ **ELECTRICAL CHARACTERISTICS** (LNA mode, 75Ω)

Conditions:  $V_{DD}=3.3V$ ,  $V_{CTL}=1.8V$ ,  $Z_s=Z_L=75\Omega$ , with application circuit

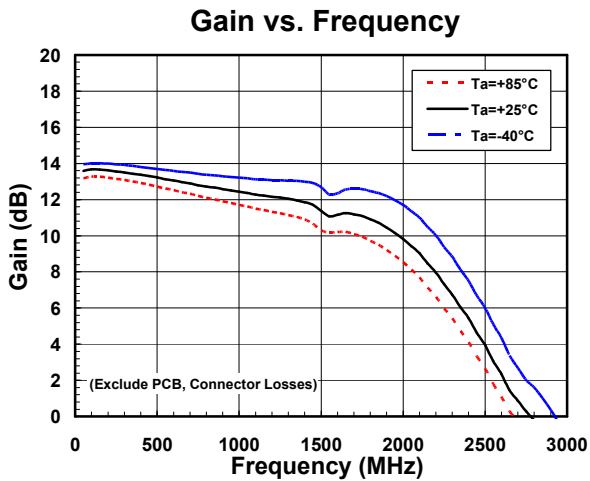
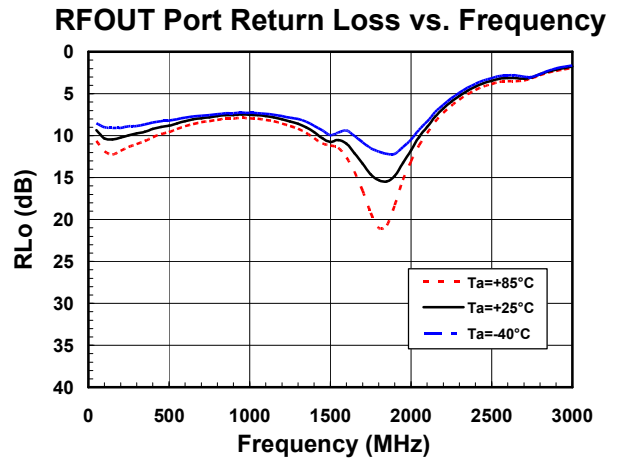
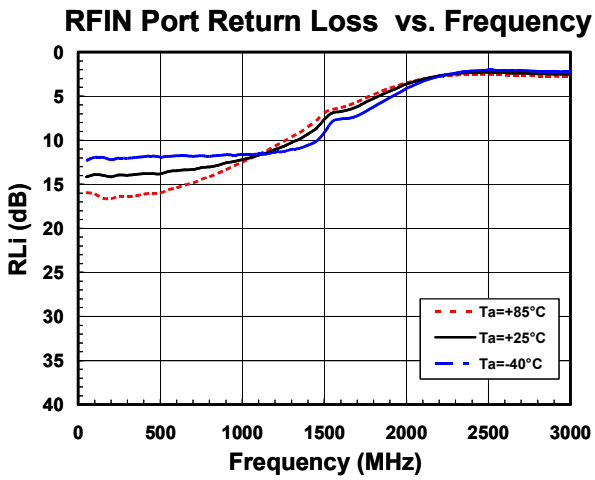

## ■ ELECTRICAL CHARACTERISTICS (LNA mode, 50Ω)

Conditions:  $V_{DD}=3.3V$ ,  $Z_s=Z_l=50\Omega$ , with application circuit

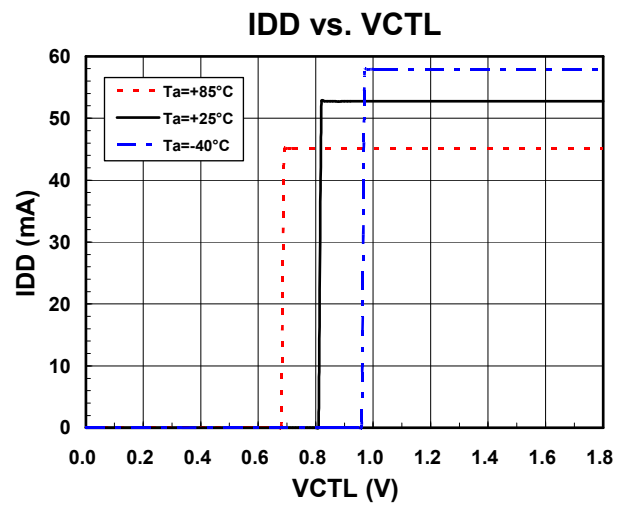
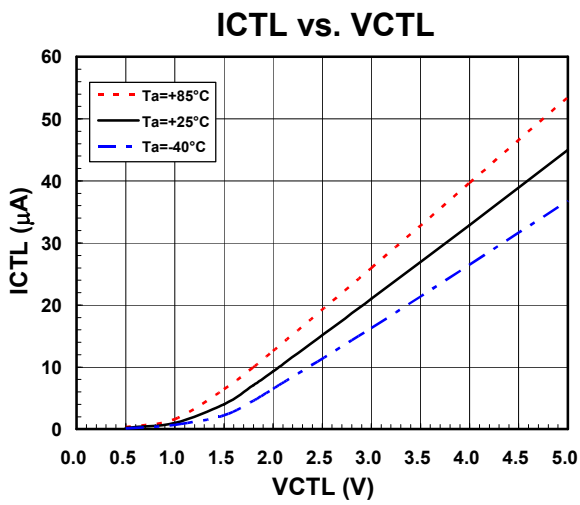

## ■ ELECTRICAL CHARACTERISTICS (Bypass mode, 50Ω)

Conditions:  $V_{DD}=3.3V$ ,  $V_{CTL}=0V$ ,  $T_a=25^\circ C$ ,  $Z_s=Z_l=50\Omega$ , with application circuit

### Loss vs. Frequency

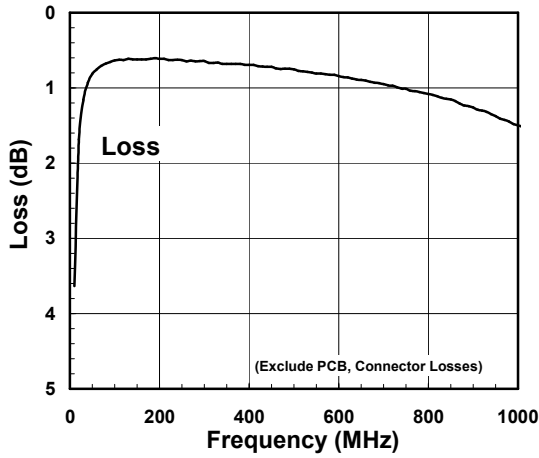

### Loss, IDD vs. Pin (f=620MHz)

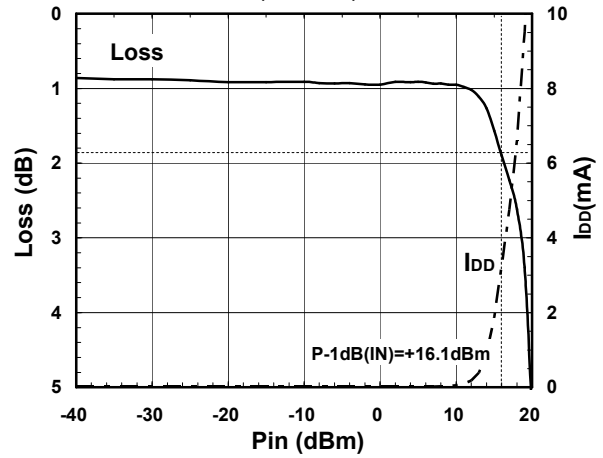

### Pout vs. Pin (f=620MHz)

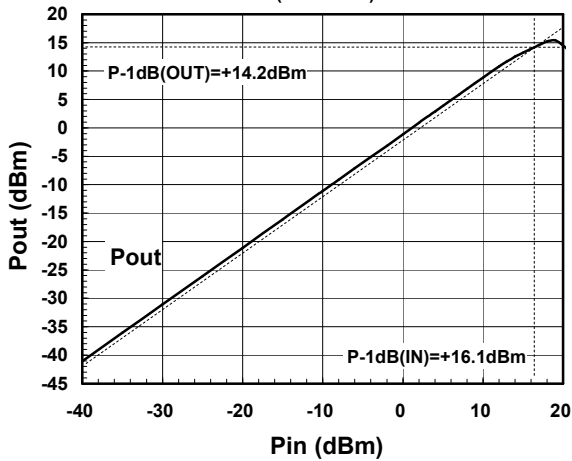

### P-1dB(IN) vs. Frequency

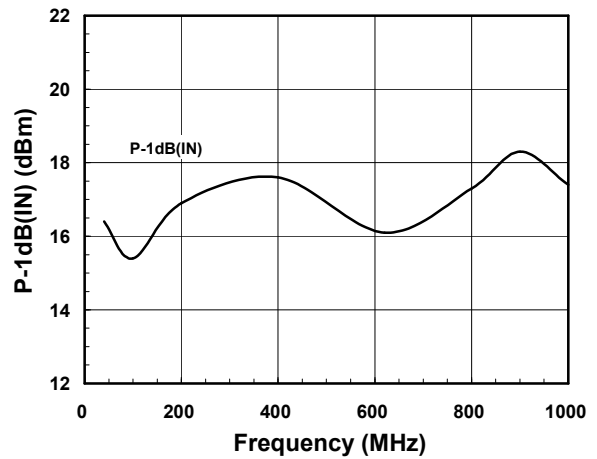

### Pout, IM3 vs. Pin (f1=620MHz, f2=620.1MHz)

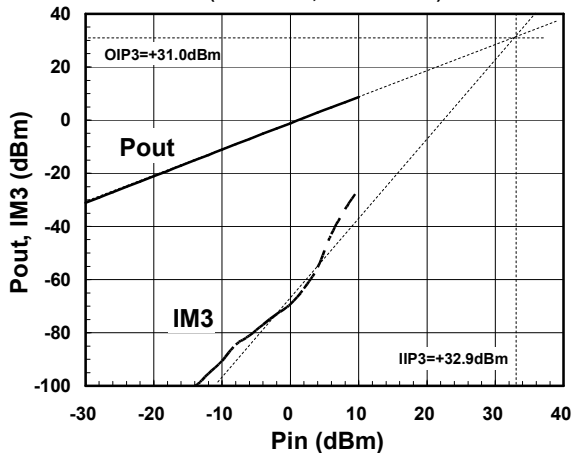

### IIP3, OIP3 vs. Frequency (f1=Frequency, f2=f1+100kHz, Pin=-2dBm)

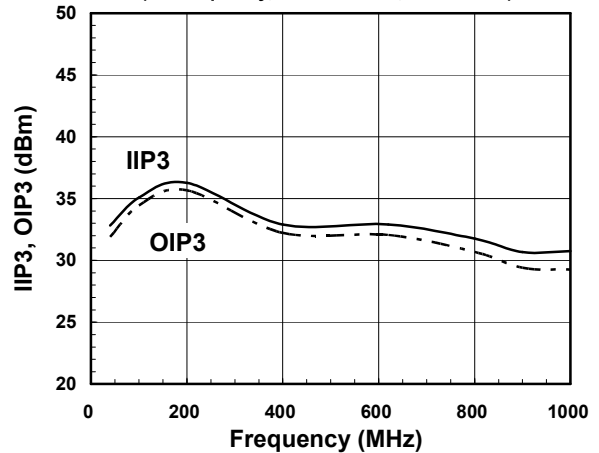



## ELECTRICAL CHARACTERISTICS (Bypass mode, 50Ω)

Conditions:  $V_{DD}=3.3V$ ,  $V_{CTL}=0V$ ,  $T_a=25^\circ C$ ,  $Z_s=Z_l=50\Omega$ , with application circuit

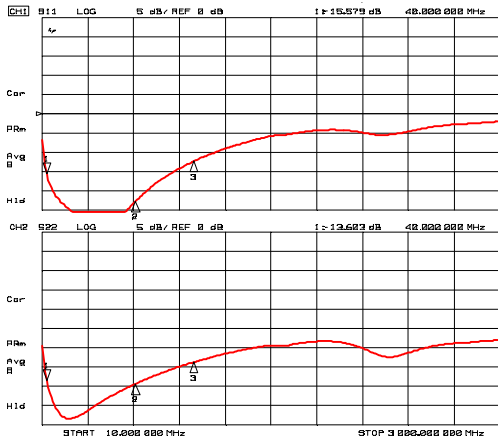

S11, S22 (f=10MHz to 3GHz)

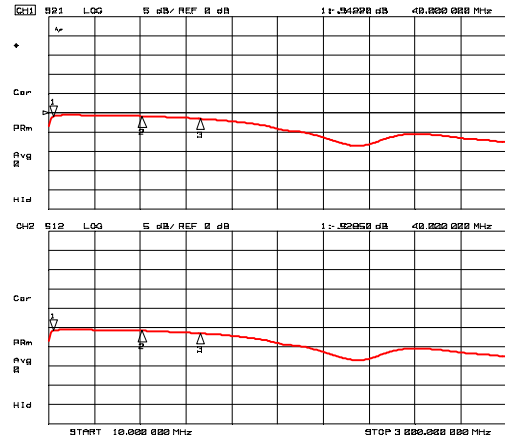

S21, S12 (f=10MHz to 3GHz)

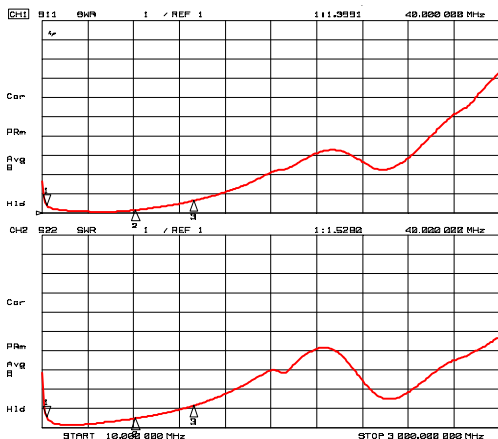

VSWR<sub>i</sub>, VSWR<sub>o</sub> (f=10MHz to 3GHz)

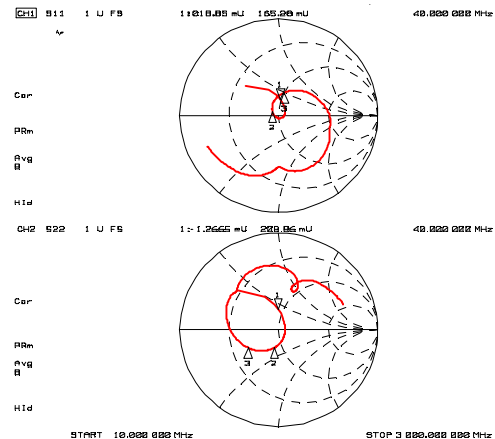

Z<sub>in</sub>, Z<sub>out</sub> (f=10MHz to 3GHz)

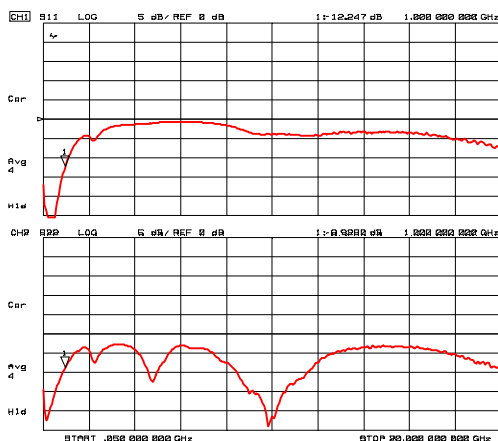

S11, S22 (f=50MHz to 20GHz)

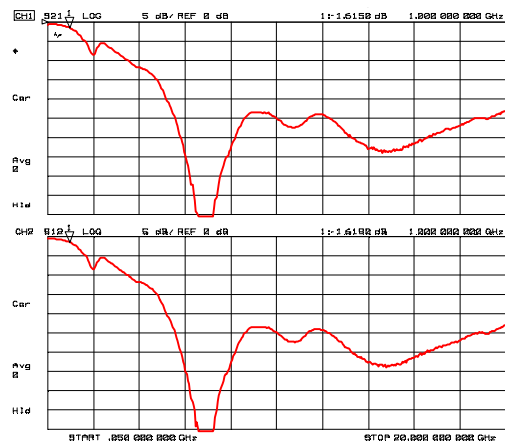

S21, S11 (f=50MHz to 20GHz)

## ■ ELECTRICAL CHARACTERISTICS (Bypass mode, 50Ω)

Conditions:  $V_{DD}=3.3V$ ,  $V_{CTL}=0V$ ,  $T_a=25^\circ C$ ,  $Z_s=Z_l=50\Omega$ , with application circuit

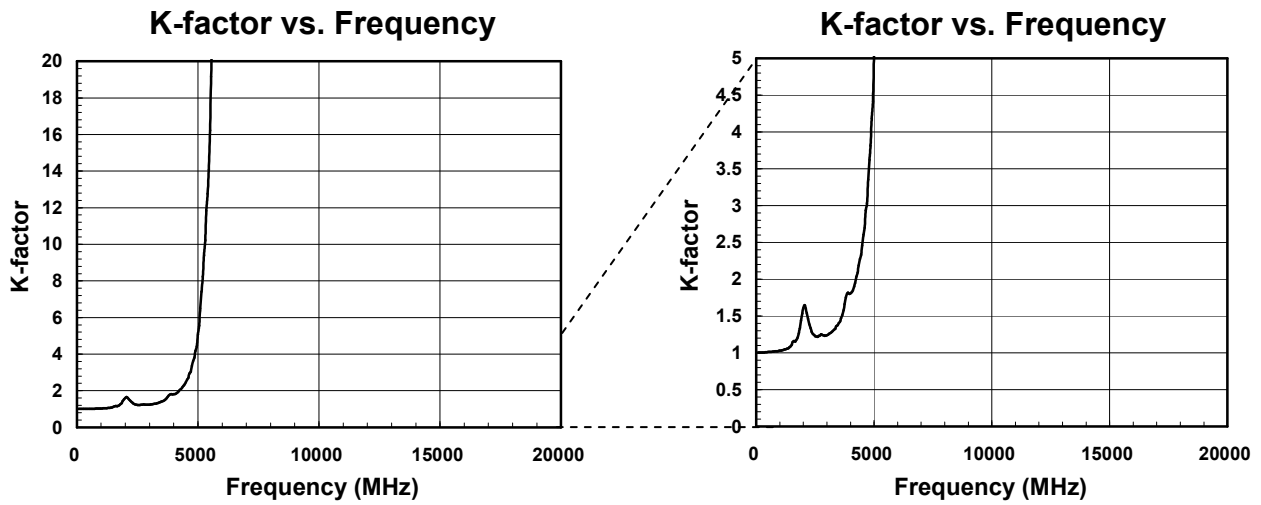

## ■ ELECTRICAL CHARACTERISTICS (Bypass mode, 75Ω)

Conditions:  $V_{DD}=3.3V$ ,  $V_{CTL}=0V$ ,  $T_a=25^\circ C$ ,  $Z_s=Z_l=75\Omega$ , with application circuit

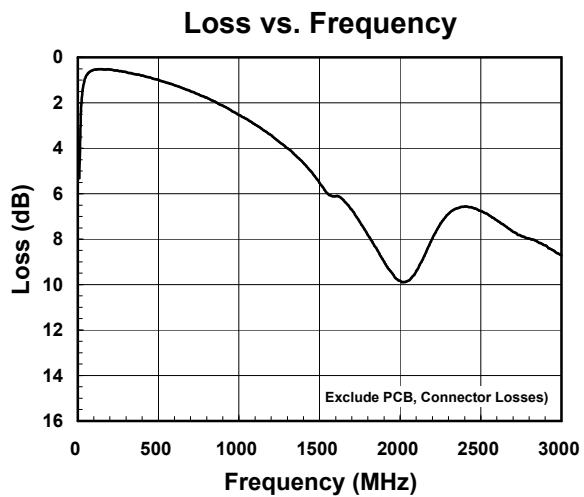
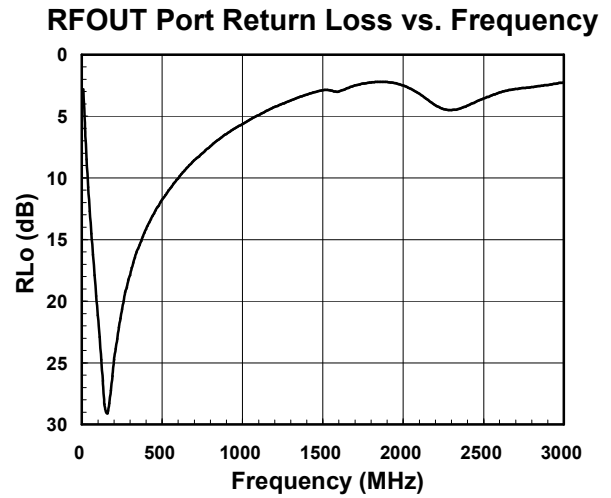
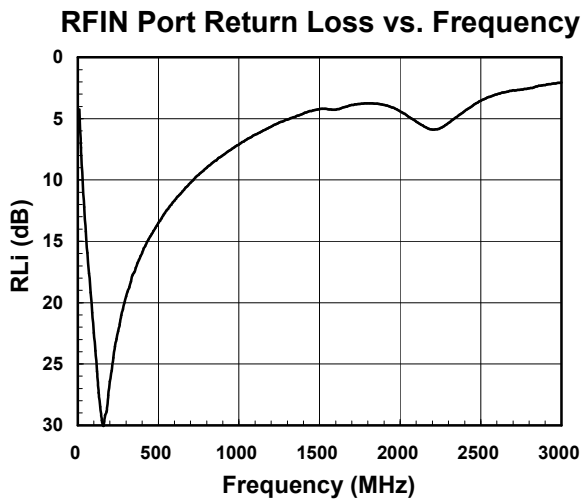

## ■ ELECTRICAL CHARACTERISTICS (Bypass mode, 50Ω)

Conditions:  $V_{CTL}=0V$ ,  $T_a=25^{\circ}C$ ,  $Z_s=Z_l=50\Omega$ , with application circuit

### IDD2 vs. VDD

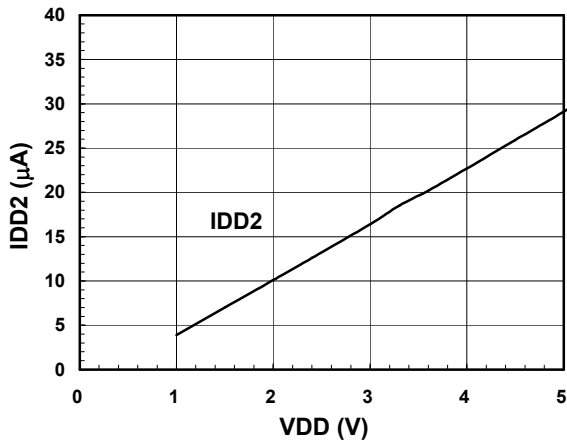

### Loss vs. Frequency

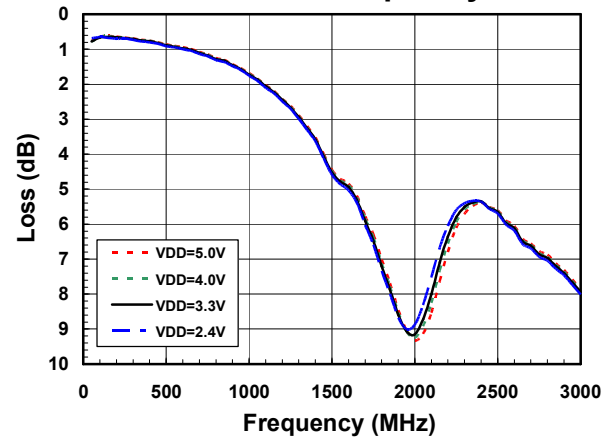

### P-1dB(IN) vs. Frequency

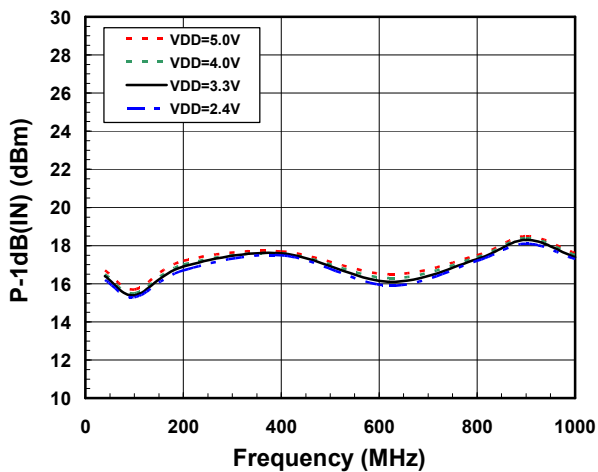

### IIP3 vs. Frequency

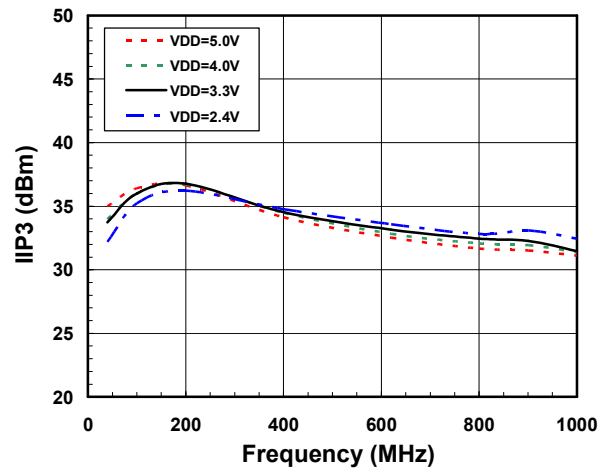

## ■ ELECTRICAL CHARACTERISTICS (Bypass mode, 50Ω)

Conditions:  $V_{CTL}=0V$ ,  $T_a=25^\circ C$ ,  $Z_s=Z_L=50\Omega$ , with application circuit

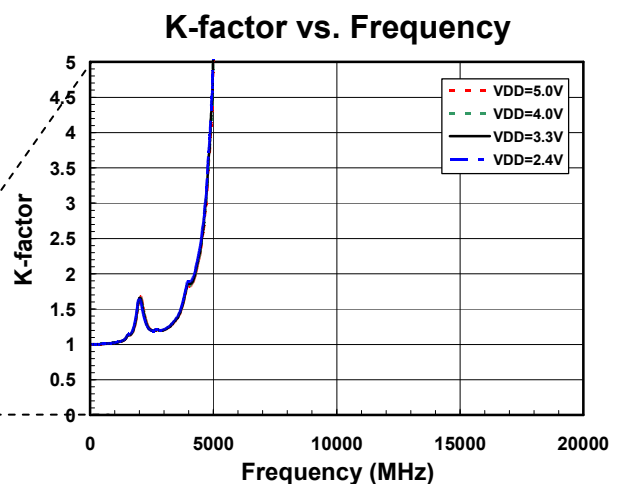
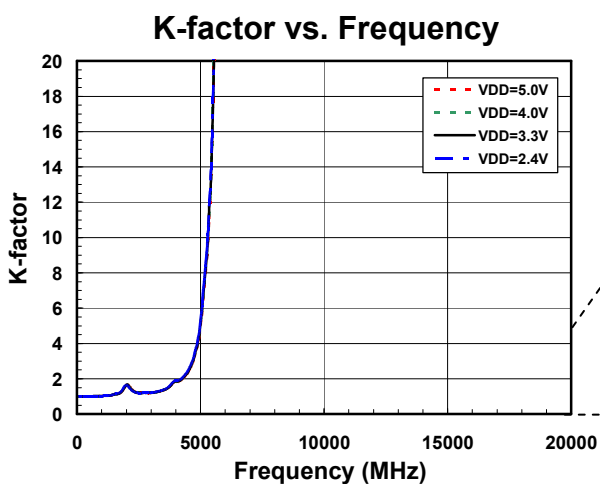
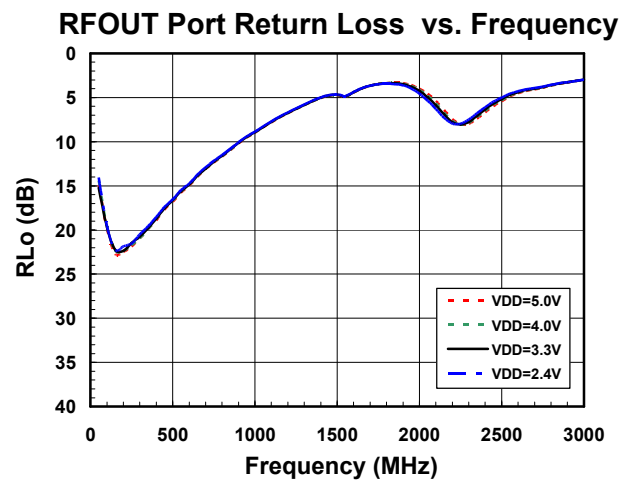
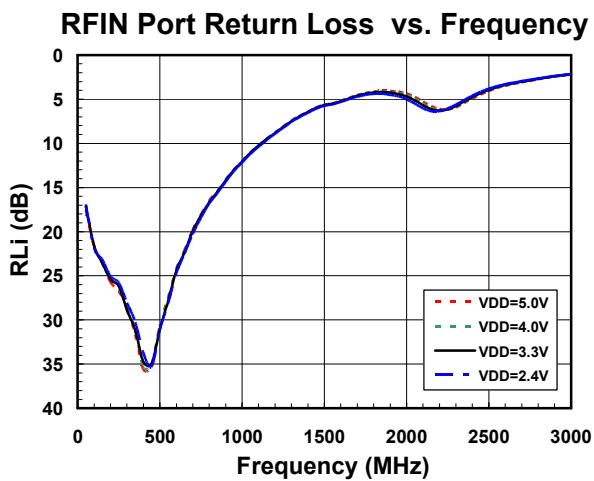
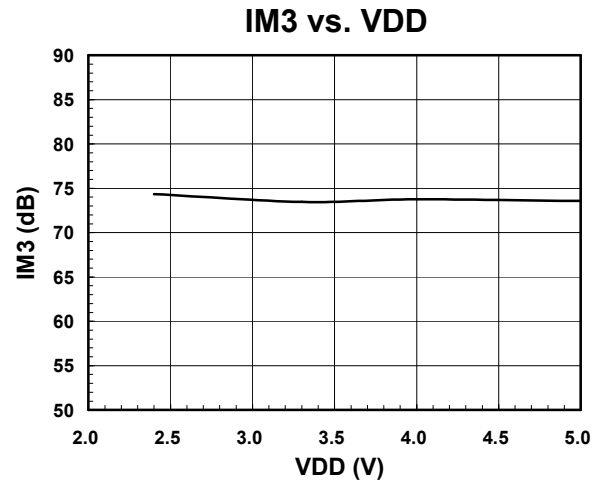
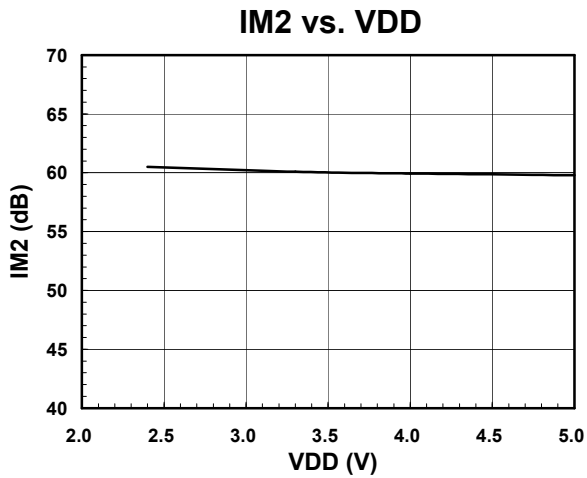

## ■ ELECTRICAL CHARACTERISTICS (Bypass mode, 75Ω)

Conditions:  $V_{CTL}=0V$ ,  $T_a=25^{\circ}C$ ,  $Z_s=Z_l=75\Omega$ , with application circuit

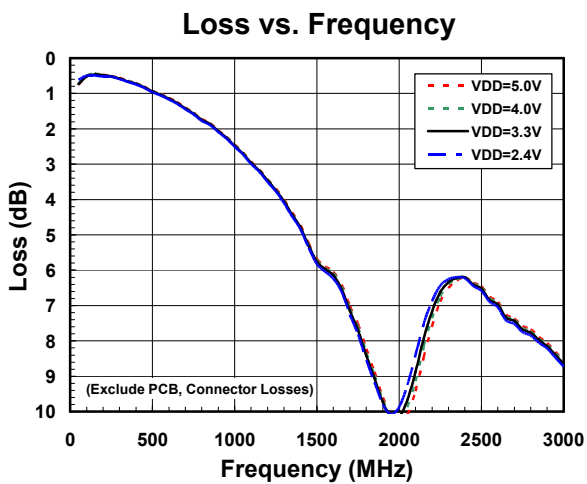
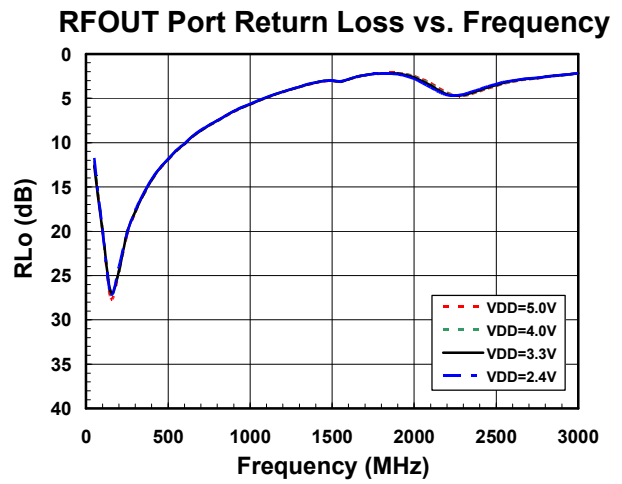
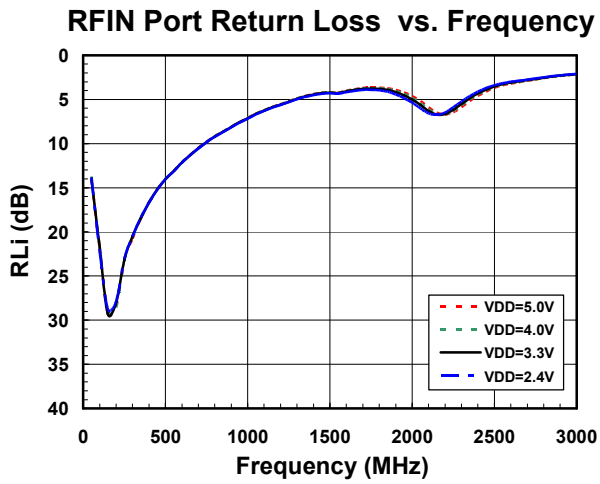

## ■ ELECTRICAL CHARACTERISTICS (Bypass mode, 50Ω)

Conditions:  $V_{DD}=3.3V$ ,  $V_{CTL}=0V$ ,  $Z_S=Z_L=50\Omega$ , with application circuit

### IDD2 vs. Ta

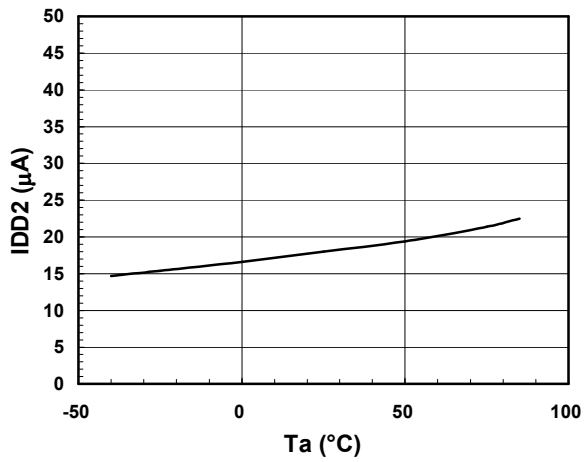

### Loss vs. Frequency

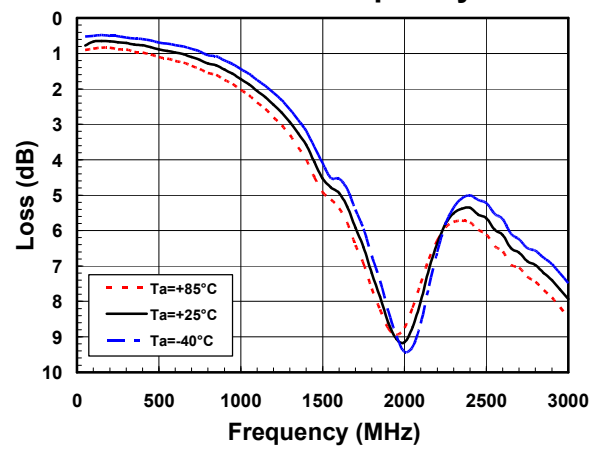

### P-1dB(IN) vs. Frequency

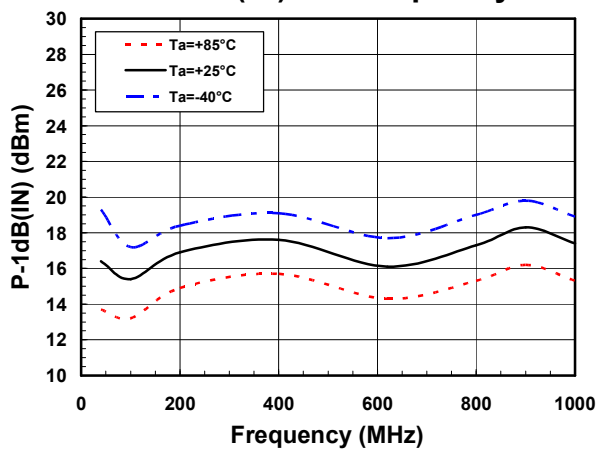

### IIP3 vs. Frequency

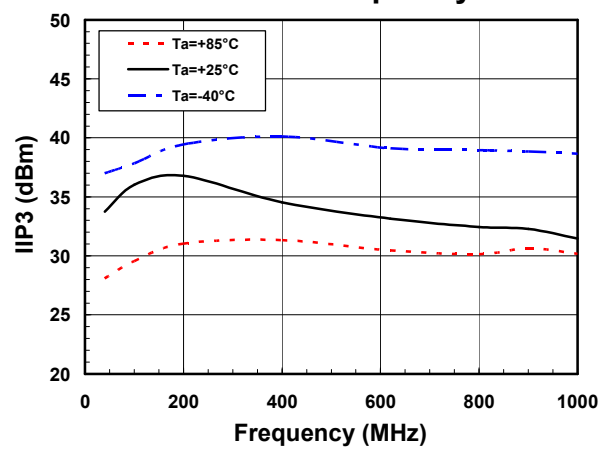

## ■ ELECTRICAL CHARACTERISTICS (Bypass mode, 50Ω)

Conditions:  $V_{DD}=3.3V$ ,  $V_{CTL}=0V$ ,  $Z_s=Z_l=50\Omega$ , with application circuit

### IM2 vs. Ta

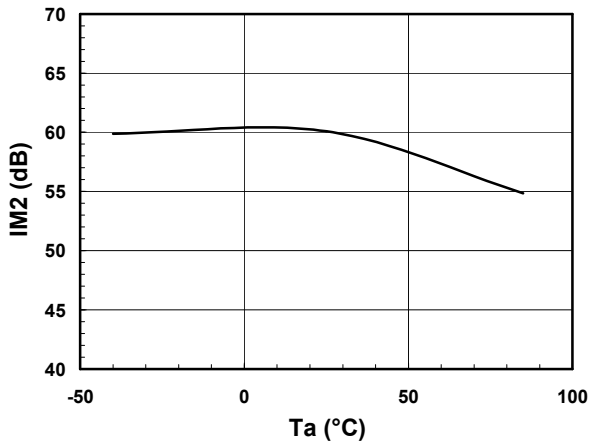

### IM3 vs. Ta

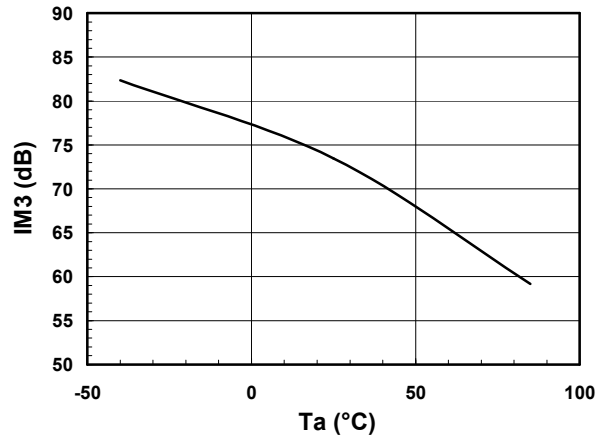

### RFIN Port Return Loss vs. Frequency

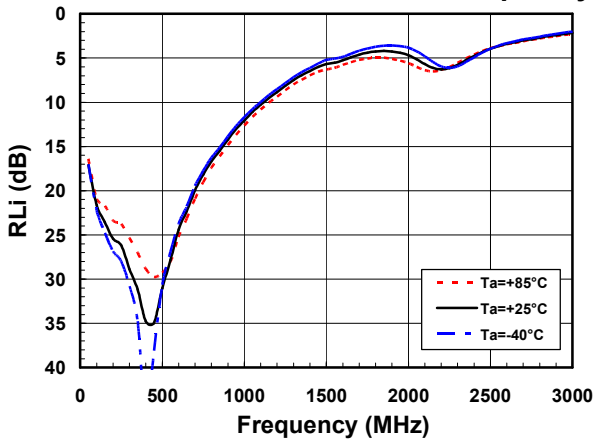

### RFOUT Port Return Loss vs. Frequency

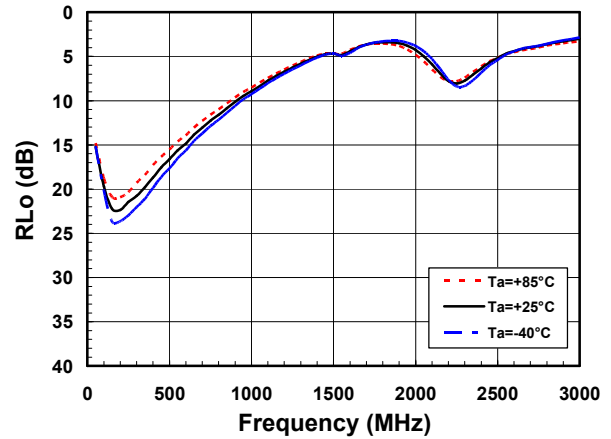

### K-factor vs. Frequency

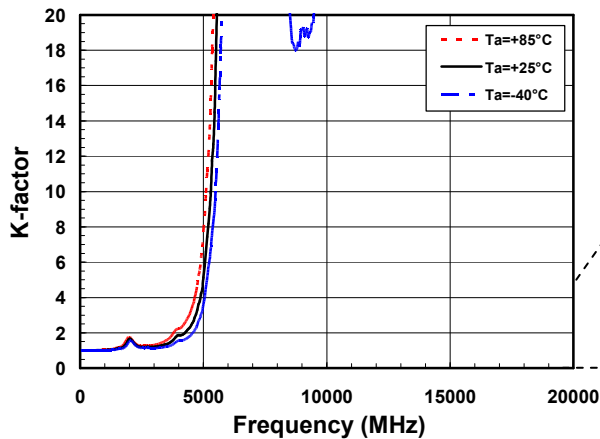

### K-factor vs. Frequency

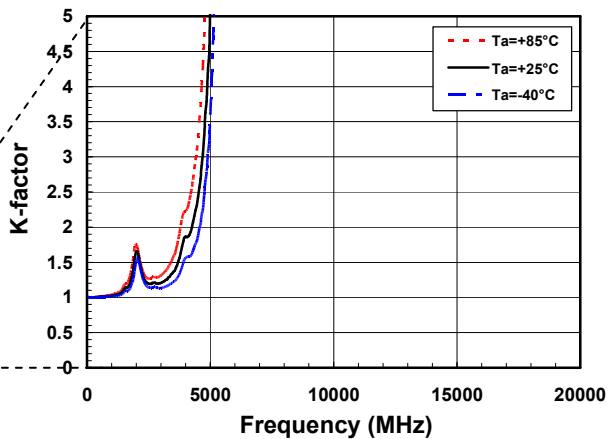



## ■ ELECTRICAL CHARACTERISTICS (Bypass mode, 75Ω)

Conditions:  $V_{DD}=3.3V$ ,  $V_{CTL}=0V$ ,  $Z_s=Z_l=75\Omega$ , with application circuit

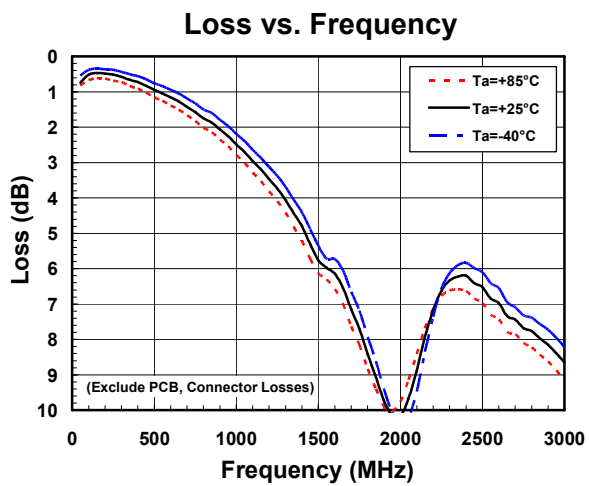
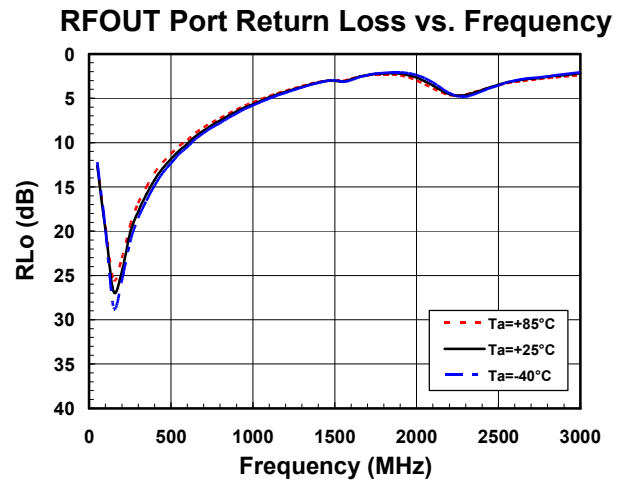
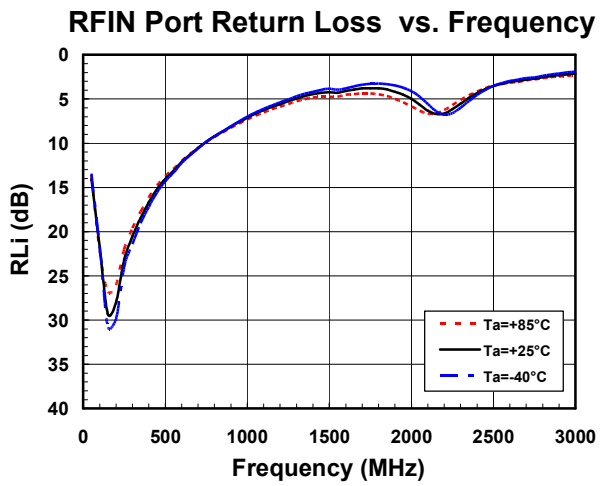

## APPLICATION CIRCUIT

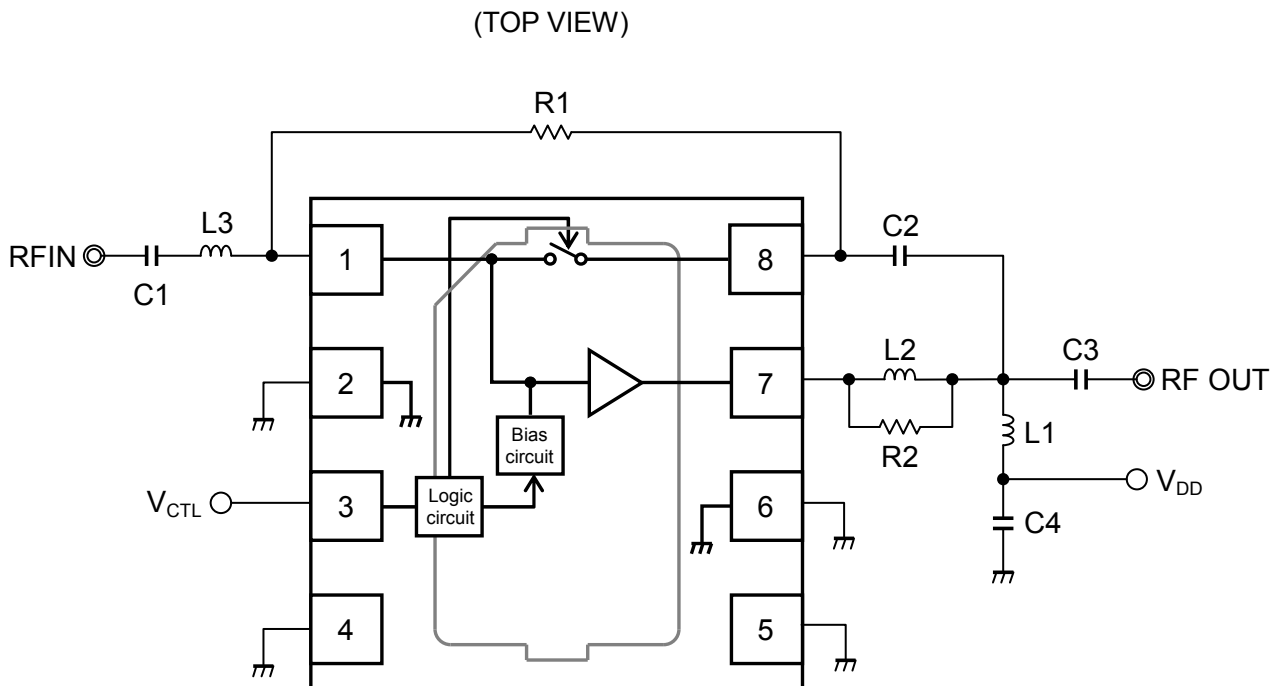

## PARTS LIST

Parts ID	Value	Notes
L1	470nH	TAIYO-YUDEN HK1608 Series
L2, L3	4.7nH	TAIYO-YUDEN HK1005 Series
C1 to C4	0.01 $\mu$ F	MURATA GRM15 Series
R1, R2	680 $\Omega$	KOA RK73 Series

## PRECAUTIONS

- C1 to C3 are DC-Blocking capacitors, and C4 is a bypass capacitor.
- L1 is RF choke inductor. (DC feed inductor)
- R1 is the feedback resistance.
- R2 is the resistance for stability.
- L2 and L3 are the inductor to adjust the impedance matching.
- All external parts, please be placed as close to the IC.
- In order not to couple with terminal RFIN and RFOUT, please layout ground pattern under the IC.

## RECOMMENDED PCB DESIGN

(TOP VIEW)

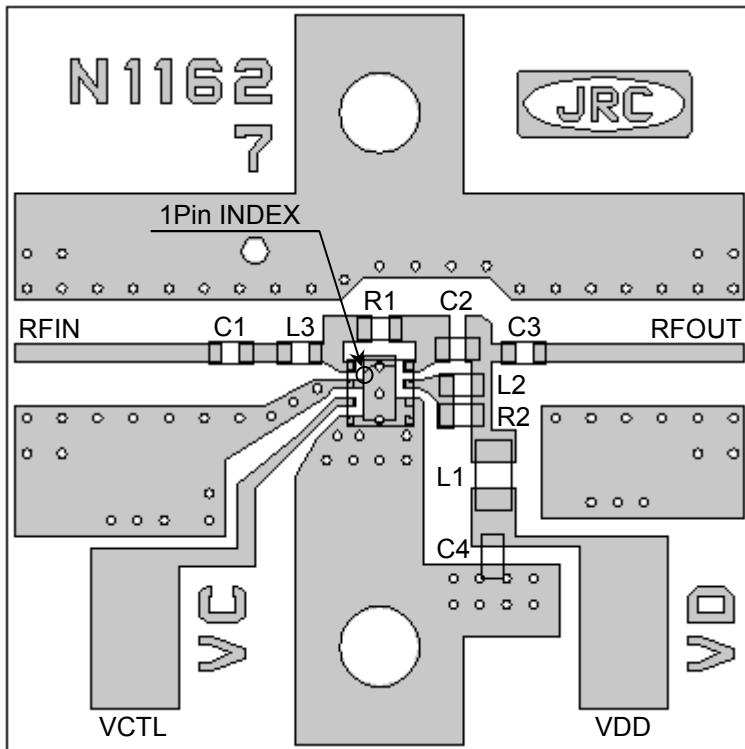

PCB (FR-4): t=0.2mm  
 Microstrip line width: 0.38mm  
 PCB size: 16.8 x 16.8mm  
 GND via hole diameter:  $\phi=0.2\text{mm}$

## PCB LAYOUT GUIDELINE

(TOP VIEW)

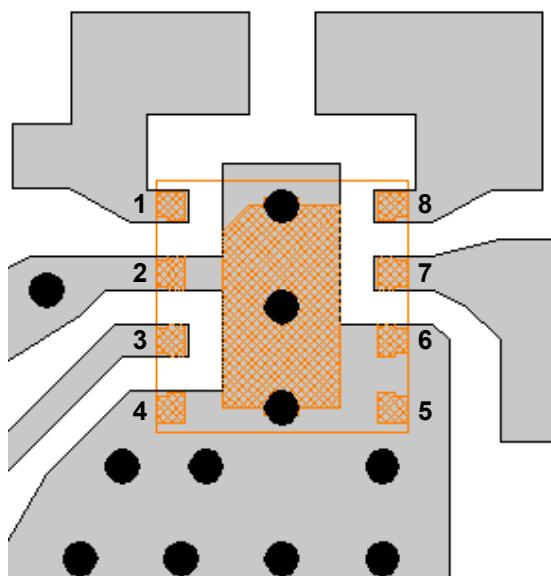

: PCB Pattern  
 : Package Terminal  
 : Package Outline  
 : GND Via Hole  
 Diameter:  $\phi=0.2\text{mm}$

## RECOMMENDED FOOTPRINT PATTERN (8pin DFN Package 1.5x1.5mm) <Reference>

Package: 1.5mm x 1.5mm

Pin pitch: 0.4mm

 : Land

 : Mask (Open area) \*Metal mask thickness: 100μm

 : Resist (Open area)

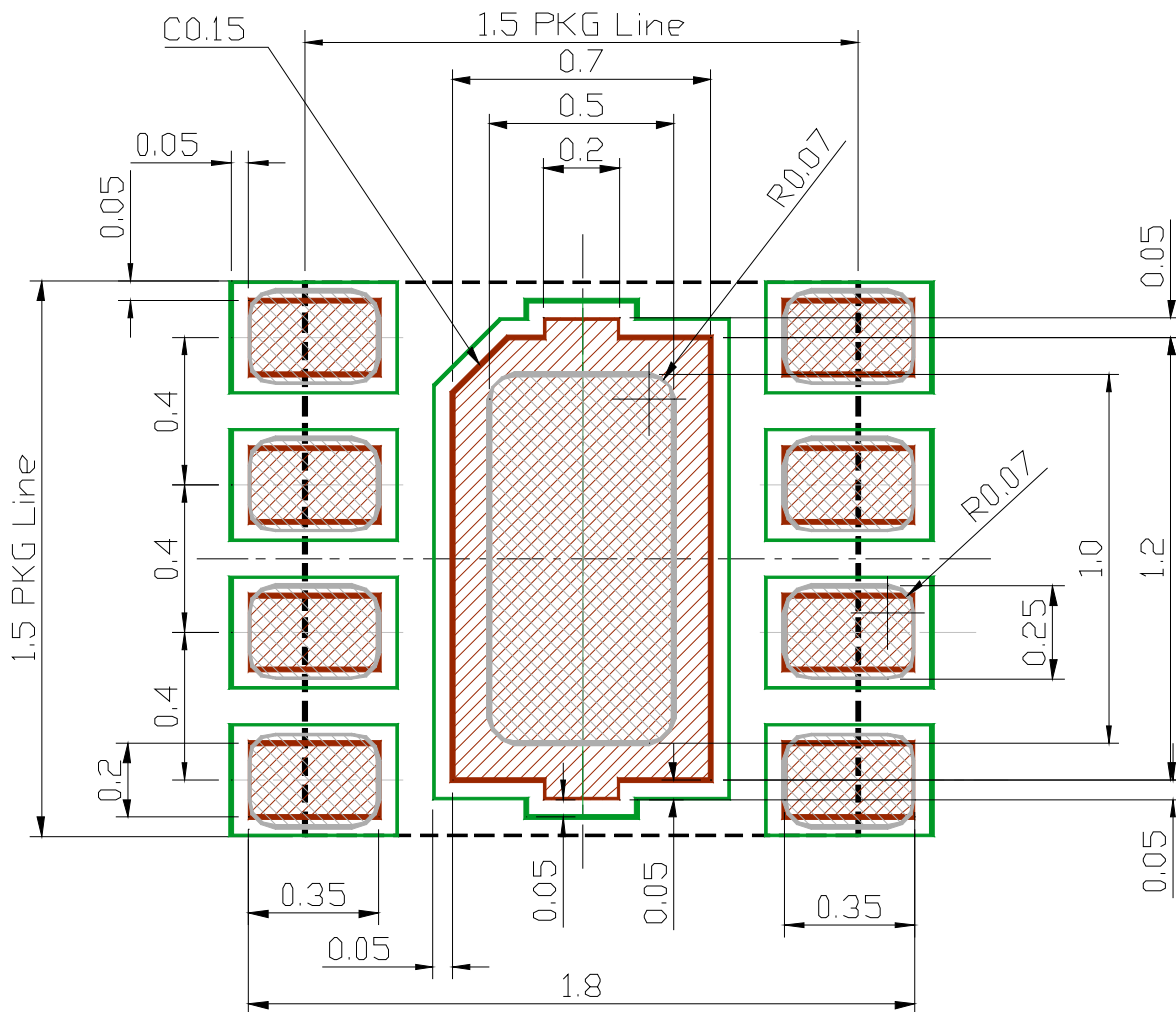

## PACKAGE OUTLINE (DFN8-64)

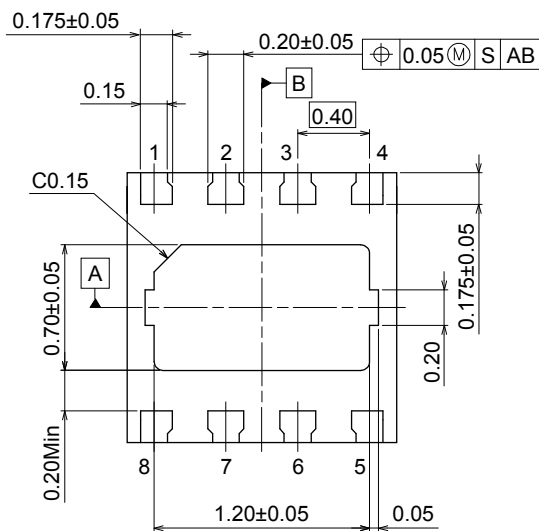
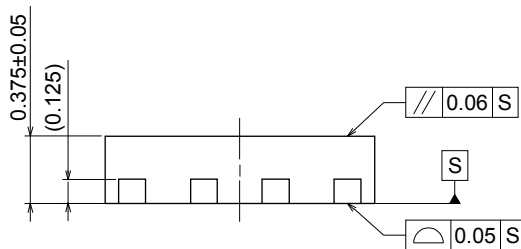
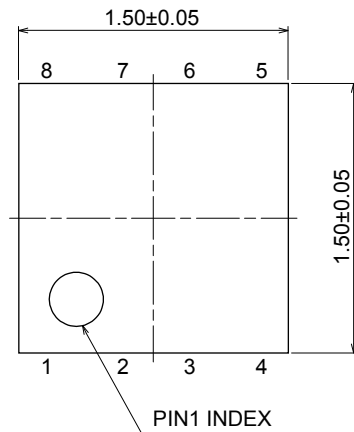

Unit	: mm
Board	: Copper
Terminal Treat	: Ni/Pd/Au plating
Molding Material	: Epoxy resin
Weight	: 2.8mg

### Cautions on using this product

- This product contains Gallium-Arsenide (GaAs) which is a harmful material.
- Do NOT eat or put into mouth.
- Do NOT dispose in fire or break up this product.
- Do NOT chemically make gas or powder with this product.
- To waste this product, please obey the relating law of your country.

### [CAUTION]

The specifications on this databook are only given for information, without any guarantee as regards either mistakes or omissions. The application circuits in this databook are described only to show representative usages of the product and not intended for the guarantee or permission of any right including the industrial rights.

This product may be damaged with electric static discharge (ESD) or spike voltage. Please handle with care to avoid these damages.