

TRANSMITTING POWER AMPLIFIER GaAs MMIC

■GENERAL DESCRIPTION

NJG1309VB2 is a positive voltage supply type GaAs power amplifier MMIC designed for Digital Cordless Phone.

Gate bias and Gain control bias terminals are supplied by positive voltage.

These terminals have high-impedance characteristics.

NJG1309VB2 can reduce power consumption at receiving mode by "Standby Function".

■PACKAGE OUTLINE

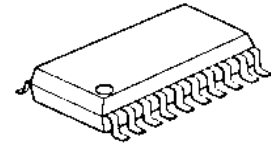

NJG1309VB2

■FEATURES

- Operating frequency range $f=1.9\text{GHz typ.}$
- Positive voltage supply $V_{DD2,3}=+3.0\text{V typ. } +V_{GG}=+1.0\text{V typ.}$
- Low current consumption $150\text{mA typ. @}21\text{dBm output power}$
- High gain $37\text{dB typ. @}21\text{dBm output power}$
- Gain control range $26\text{dB typ. @}21\text{dBm output power}$
- Package SSOP20-B2 (Pin pitch 0.5mm)

■PIN CONFIGURATION

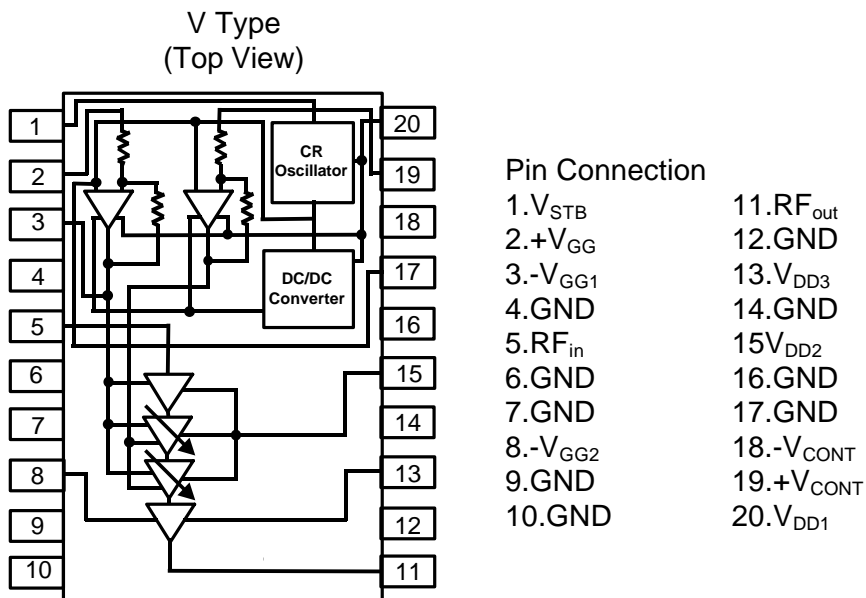

NJG1309VB2

■ABSOLUTE MAXIMUM RATINGS

($Z_s=Z_l=50\Omega$, $T_a=25^\circ\text{C}$)

PARAMETER	SYMBOL	CONDITIONS	RATINGS	UNITS
Drain Voltage 1	V_{DD1}	$+V_{GG}=1.0\text{V}$	5.5	V
Drain Voltage 2	$V_{DD2,3}$	$+V_{GG}=1.0\text{V}$	6.0	V
Gate Voltage	$+V_{GG}$	$V_{DD2,3}=3.0\text{V}$	$-0.5\sim V_{DD1}+0.5$	V
Gain Control Voltage	$+V_{CONT}$	$V_{DD2,3}=3.0\text{V}$	$-0.5\sim V_{DD1}+0.5$	V
Standby Voltage	V_{STB}		$-0.5\sim V_{DD1}+0.5$	V
Input Power	P_{in}	$V_{DD2,3}=3.0\text{V}$, $+V_{GG}=1.0\text{V}$	3.0	dBm
Power Dissipation	P_D	At on PCB board	600	mW
Operating Temperature	T_{opr}		$-40\sim+85$	$^\circ\text{C}$
Storage Temperature	T_{stg}		$-55\sim+150$	$^\circ\text{C}$

■ELECTRICAL CHARACTERISTICS 1

($V_{DD1}=3\text{V}$, $V_{STB}=2.7\text{V}$, $+V_{CONT}=0\text{V}$, $f=1.9\text{GHz}$, $Z_s=Z_l=50\Omega$, $T_a=25^\circ\text{C}$)

PARAMETER	SYMBOL	CONDITIONS	MIN	TYP	MAX	UNITS
Operating frequency	freq	$V_{DD2,3}=3.0\text{V}$	1.85	1.90	1.95	GHz
Drain Voltage 1	V_{DD1}		2.7	3.0	5.2	V
Drain Voltage 2	$V_{DD2,3}$		2.9	3.0	5.2	V
Standby Terminal Input Voltage (H)	$V_{STB(H)}$		2.4	2.7	3.0	V
Standby Terminal Input Voltage (L)	$V_{STB(L)}$		0.0	0.0	0.6	V
Gain Control Voltage	$+V_{CONT}$		0.0	-	2.0	V
Gate Voltage	$+V_{GG}$	$V_{DD2,3}=3.0\text{V}$, $I_{idle}=130\text{mA}$	0.6	1.0	1.4	V
Idle Current *1	I_{idle}	$V_{DD2,3}=3.0\text{V}$, RF OFF	125	130	135	mA
Operating Current *1	$I_{DD2,3}$	$V_{DD2,3}=3.0\text{V}$, $I_{idle}=130\text{mA}$ $P_{out}=21\text{dBm}$	-	150	165	mA
V_{DD1} Terminal Current(H)	$I_{DD1(H)}$	$V_{DD2,3}=3\text{V}$, $P_{out}=21\text{dBm}$	-	0.9	1.25	mA
V_{DD1} Terminal Current(L)	$I_{DD1(L)}$	$V_{STB}=0\text{V}$, $V_{DD2,3}=0\text{V}$	-	0.5	1.0	μA
V_{GG1} Terminal Current	I_{GG}	$+V_{GG}=2.0\text{V}$	-	5	10	μA
$+V_{CONT}$ Terminal Current	I_{CONT}	$+V_{CONT}=2.0\text{V}$	-	5	10	μA

■ ELECTRICAL CHARACTERISTICS 1

($V_{DD1}=3V$, $V_{STB}=2.7V$, $+V_{CONT}=0V$, $f=1.9GHz$, $Z_s=Z_l=50\Omega$, $T_a=25^\circ C$)

PARAMETER	SYMBOL	CONDITIONS	MIN	TYP	MAX	UNIT
V_{STB} Terminal Current	I_{STB}		-	0.5	1.0	μA
$-V_{GG}, -V_{CONT}$ Rise Time*2	TRDD	0.01 μF Load Capacitance	-	-	400	μSEC
$-V_{GG}, -V_{CONT}$ Fall Time*2	T_{STB}		-	-	20	mSEC
$+V_{GG}$ Terminal Input Resistance	R1		300	500	700	$k\Omega$
$+V_{CONT}$ Terminal Input Resistance	R2		300	500	700	$k\Omega$
Power Gain	Gain	$V_{DD2,3}=3.0V$, $I_{idle}=130mA$ $P_{out}=21dBm$	34	37	40	dB
Gain Flatness	G_{flat}	$V_{DD2,3}=3.0V$, $I_{idle}=130mA$ $P_{out}=21dBm$	-	1.0	1.5	dB
Gain Control Range	G_{cont}	$V_{DD2,3}=3.0V$, $I_{idle}=130mA$ $P_{out}=21dBm$ $+V_{CONT}=0.0$ to $2.0V$	21	26	31	dB
Pout at 1dB Gain Compression point	P_{-1dB}	$V_{DD2,3}=3.0V$, $I_{idle}=130mA$	-	21	-	dBm
Harmonics	P_{hm}	$V_{DD2,3}=3.0V$, $I_{idle}=130mA$ $P_{out}=21dBm$	-	-40	-30	dBc
Load VSWR tolerance	-	$V_{DD2,3}=3.0V$, $I_{idle}=130mA$ $P_{out}=21dBm$, Load VSWR=1:4 All Phase	Parasitic oscillation for fundamental signal level: $\leq -60dBc$			-

*1: Total current of V_{DD2} terminal and V_{DD3} terminal.

*2: Timing chart of input terminal voltage is mentioned in the separate sheet of paper.

NJG1309VB2

■ ELECTRICAL CHARACTERISTICS 2

($V_{DD1}=3V$, $V_{STB}=2.7V$, $+V_{CONT}=0V$, $f=1.765GHz$, $Z_s=Z_l=50\Omega$, $T_a=25^\circ C$)

PARAMETER	SYMBOL	CONDITIONS	MIN	TYP	MAX	UNITS
Operating frequency	freq	$V_{DD2,3}=3.0V$	1.750	1.765	1.780	GHz
Drain Voltage 1	V_{DD1}		2.7	3.0	5.2	V
Drain Voltage 2	$V_{DD2,3}$		2.9	3.0	5.2	V
Standby Terminal Input Voltage (H)	$V_{STB}(H)$		2.4	2.7	3.0	V
Standby Terminal Input Voltage (L)	$V_{STB}(L)$		0.0	0.0	0.6	V
Gain Control Voltage	$+V_{CONT}$		0.0	-	2.0	V
Gate Voltage	$+V_{GG}$	$V_{DD2,3}=3.0V$, $I_{idle}=130mA$	0.6	1.0	1.4	V
Idle Current *1	I_{idle}	$V_{DD2,3}=3.0V$, RF OFF	125	130	135	mA
Operating Current *1	$I_{DD2,3}$	$V_{DD2,3}=3.0V$, $I_{idle}=130mA$ $P_{out}=21dBm$	-	155	-	mA
V_{DD1} Terminal Current(H)	$I_{DD1}(H)$	$V_{DD2,3}=3V$, $P_{out}=21dBm$	-	0.9	-	mA
V_{DD1} Terminal Current(L)	$I_{DD1}(L)$	$V_{STB}=0V$, $V_{DD2,3}=0V$	-	0.5	-	μA
V_{GG} Terminal Current	I_{GG}	$+V_{GG}=2.0V$	-	5	-	μA
$+V_{CONT}$ Terminal Current	I_{CONT}	$+V_{CONT}=2.0V$	-	5	-	μA
V_{STB} Terminal Current	I_{STB}		-	0.5	-	μA
$-V_{GG}, -V_{CONT}$ Rise Time*2	TRDD	0.01 μF Load Capacitance	-	-	400	μSEC
$-V_{GG}, -V_{CONT}$ Fall Time*2	T_{STB}		-	-	20	mSEC
$+V_{GG}$ Terminal Input Resistance	R1		300	500	700	$k\Omega$
$+V_{CONT}$ Terminal Input Resistance	R2		300	500	700	$k\Omega$
Power Gain	Gain	$V_{DD2,3}=3.0V$, $I_{idle}=130mA$ $P_{out}=21dBm$	-	36	-	dB
Gain Flatness	G_{flat}	$V_{DD2,3}=3.0V$, $I_{idle}=130mA$ $P_{out}=21dBm$	-	0.5	-	dB
Gain Control Range	G_{cont}	$V_{DD2,3}=3.0V$, $I_{idle}=130mA$ $P_{out}=21dBm$ $+V_{CONT}=0.0$ to $2.0V$	-	25	-	dB
Output Power at 1dB Compression point	P_{-1dB}	$V_{DD2,3}=3.0V$, $I_{idle}=130mA$	-	20	-	dBm
Harmonics	P_{hm}	$V_{DD2,3}=3.0V$, $I_{idle}=130mA$ $P_{out}=21dBm$	-	-40	-	dBc

■ ELECTRICAL CHARACTERISTICS 2

($V_{DD1}=3V$, $V_{STB}=2.7V$, $+V_{CONT}=0V$, $f=1.765GHz$, $Z_s=Z_l=50\Omega$, $T_a=25^\circ C$)

PARAMETER	SYMBOL	CONDITIONS	MIN	TYP	MAX	UNITS
Load VSWR tolerance	-	$V_{DD2,3}=3.0V$, $I_{idle}=130mA$ $P_{out}=21dBm$, Load VSWR=1:4 All Phase				-

*1: Total current of V_{DD2} terminal and V_{DD3} terminal.

*2: Timing chart of input terminal voltage is mentioned in the separate sheet of paper.

NJG1309VB2

■TIMING CHART

1) Timing chart of setting and shut of supply voltage and control voltage, V_{DD1} , $+V_{GG}$, and V_{CONT} .

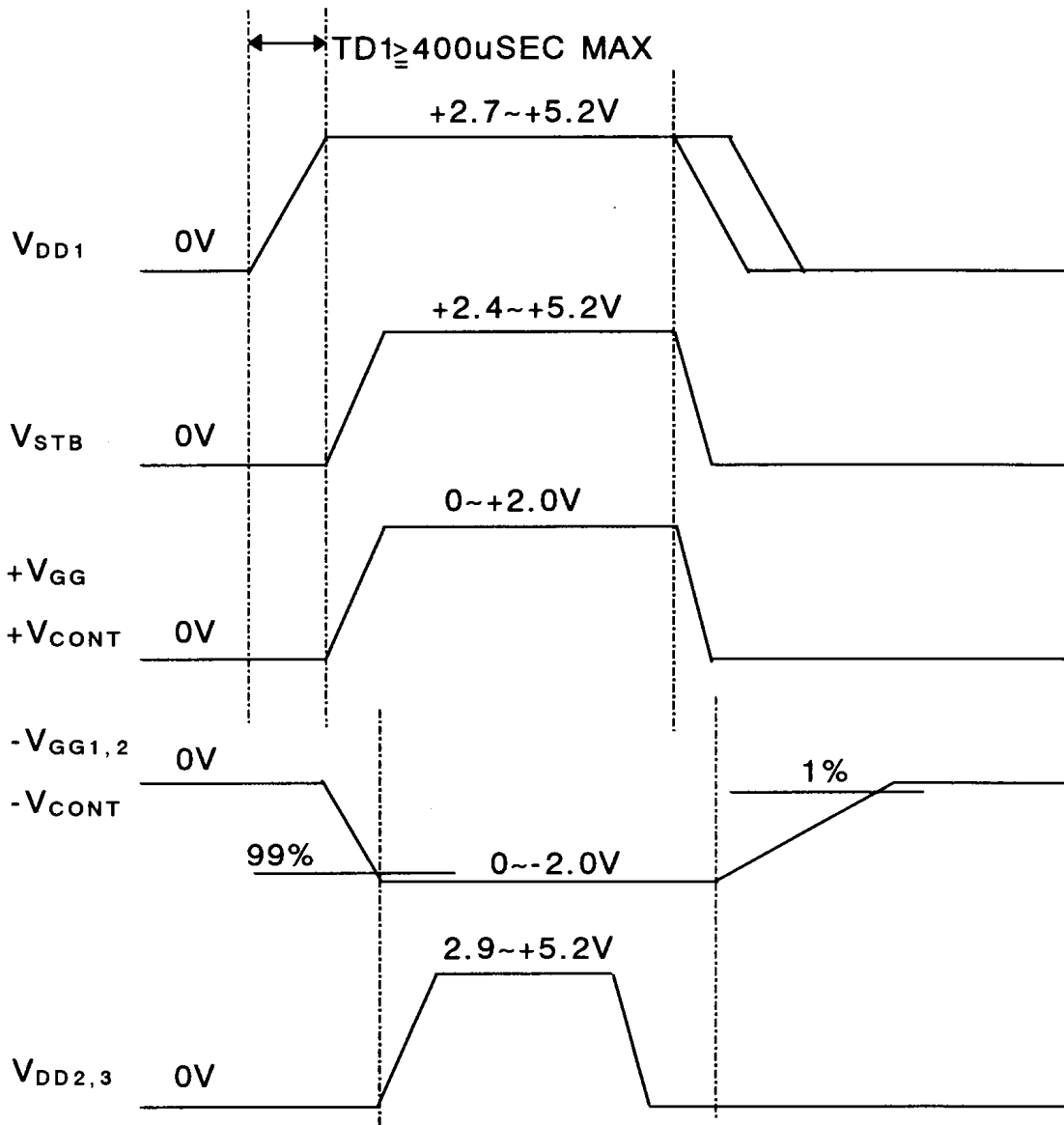

Notes

- (1) To prevent latch-up, V_{DD1} should be more than $V_{STB} + V_{GG}$ and $+V_{CONT}$.
- (2) The rising time of V_{DD1} is 400uSEC maximum in case of the recommended circuit.

■TIMING CHART

2) Timing chart of burst operation using V_{STB} .

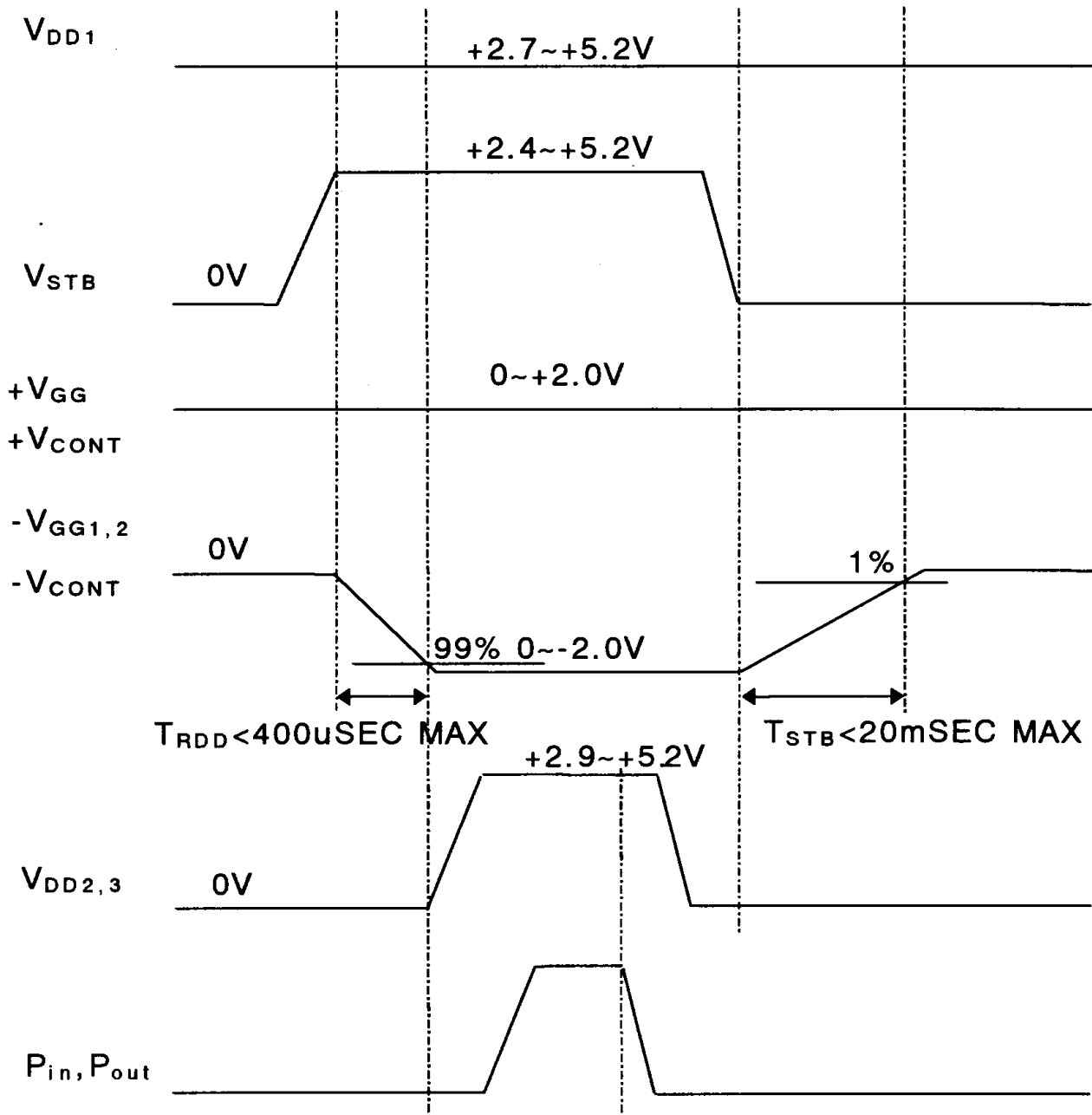

NJG1309VB2

■ TERMINAL INFORMATION

TERMINAL INFORMATION		
PIN No.	SYMBOL	DESCRIPTIONS
1	V_{STB}	The output voltage of DC/DC converter is toggled ON/OFF by changing voltage to this terminal to High/Low.
2	$+V_{GG}$	The positive voltage of this terminal is supplied to op-amp 1 in the DC/DC converter, and its output voltage (negative) is internally supplied to the gate ports of #1 to 3 amplifiers. The current of amplifier is controlled by the voltage of this terminal.
3	$-V_{GG1}$	The voltage of the gate ports of #1 to 3 amplifier are supplied through this terminal. Please place a capacitor at this terminal as close as possible.
4	GND	Ground terminal(0V)
5	RF_{in}	This terminal is a signal input terminal connected to input port of amplifier through matching circuit and DC blocking capacitor.
6	GND	Ground terminal(0V)
7	GND	Ground terminal(0V)
8	$-V_{GG2}$	This terminal is Connected to gate fourth stage amplifier. Please connect with $-V_{GG2}$ terminal on PCB board and place a bypass possible , since this terminal is NOT connected with op-amp input.
9	GND	Ground terminal(0V)
10	GND	Ground terminal(0V)
11	RF_{out}	This terminal is a signal output terminal connected to the output port of amplifier through matching circuit and DC blocking capacitor.
12	GND	Ground terminal(0V)
13	V_{DD3}	This terminal is connected to drain port of fourth stage amplifier. Please place a choke inductor and a bypass capacitor shown in the application circuit below.
14	GND	Ground terminal(0V)
15	V_{DD2}	The voltage of the gate ports of #1 to 3 amplifier are supplied through this terminal. Please place a capacitor at this terminal as close as possible.
16	GND	Ground terminal(0V)
17	GND	Ground terminal(0V)
18	$-V_{CONT}$	This terminal is a gain control terminal of amplifier, and also internally connected to output port of op-amp2. Please place a bypass capacitor at this terminal shown in the application circuit below as close as possible.
19	$+V_{CONT}$	The positive voltage of this terminal is supplied to op-amp2 in the DC/Dc converter, and its output voltage(negative) is internally supplied to the gain control port of amplifier. The gain of amplifier is controlled by the voltage of this terminal.
20	V_{DD1}	This terminal is a voltage supply terminal of DC/DC converter. Please place bypass capacitor shown in the application circuit below as close as possible.

NOTE 1) The ground terminal(4,6,7,9,10,12,14,16,17)shond be directly connected to ground plane To minimize fringing inductance.

■ TYPICAL CHARACTERISTICS

Timing Chart 1 (+V_{GG}: DC, X-axis: 1msec/div)
 $V_{DD1}=3V_{dc}$, $+V_{GG}=1V_{dc}$, $+V_{CONT}=0V$
 V_{STB} : $V_0-p=3V$, Period=5msec, Duty=50%

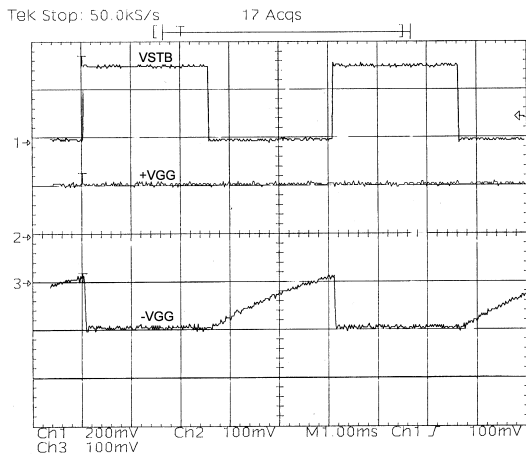

Timing Chart 2 (+V_{GG}: DC, X-axis: 100usec/div)
 $V_{DD1}=3V_{dc}$, $+V_{GG}=1V_{dc}$, $+V_{CONT}=0V$
 V_{STB} : $V_0-p=3V$, Period=5msec, Duty=50%

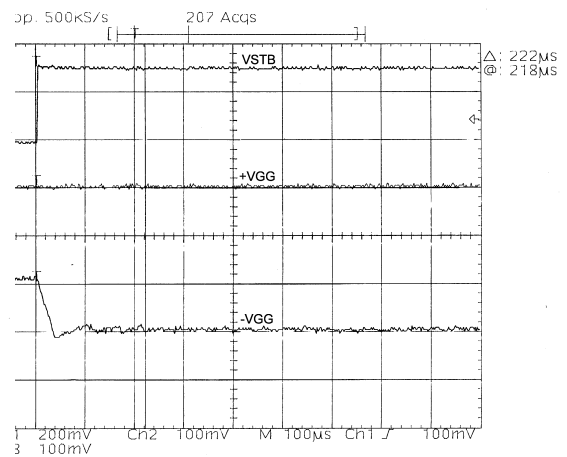

Timing Chart 3 (+V_{GG}: Pulse, X-axis: 1msec/div)
 $V_{DD1}=3V_{dc}$, $+V_{CONT}=0V$
 $+V_{GG}$: $V_0-p=1V$, Period=5msec, Duty=50%
 V_{STB} : $V_0-p=3V$, Period=5msec, Duty=50%

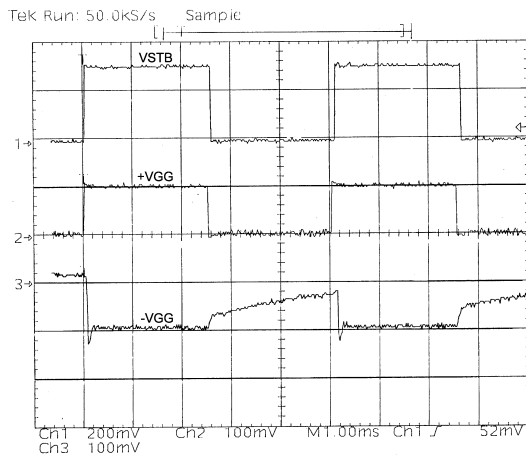

Timing Chart 4 (+V_{GG}: Pulse, X-axis: 100usec/div)
 $V_{DD1}=3V_{dc}$, $+V_{CONT}=0V$
 $+V_{GG}$: $V_0-p=1V$, Period=5msec, Duty=50%
 V_{STB} : $V_0-p=3V$, Period=5msec, Duty=50%

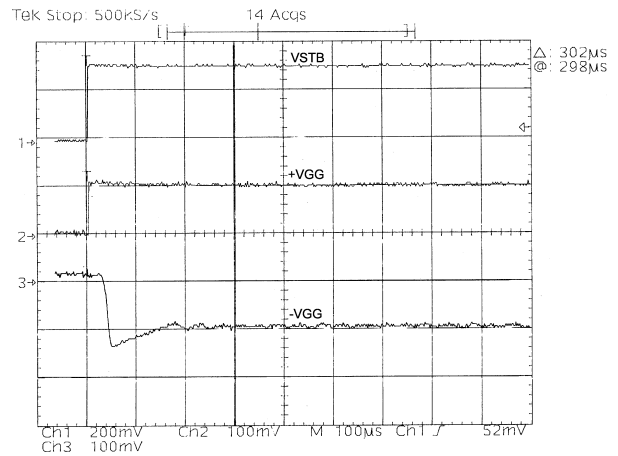

Real vertical voltage scale should be ten times higher than the scale indicated under each graph, because 1:10 probes are used on all of Ch1, Ch2 and Ch3.

NJG1309VB2

TYPICAL CHARACTERISTICS

Small Signal Power Gain vs. Frequency

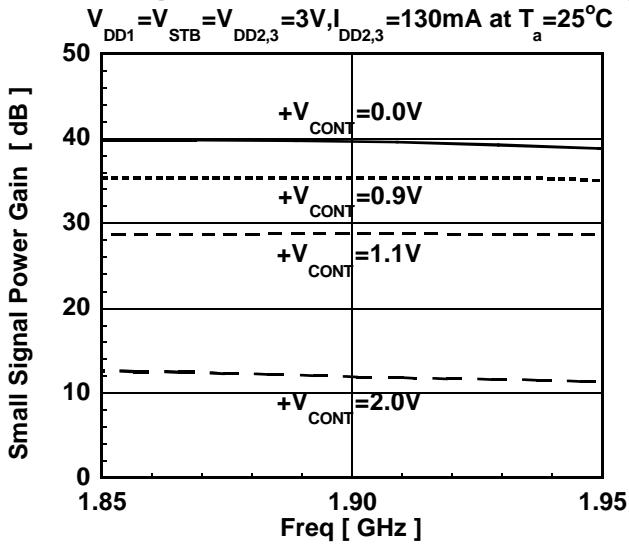

Small Signal Power Gain vs. Frequency

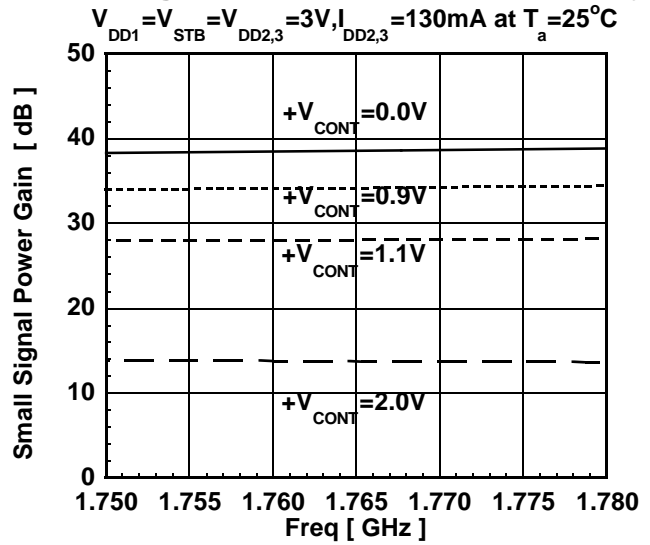

Small Signal Power Gain vs. Frequency

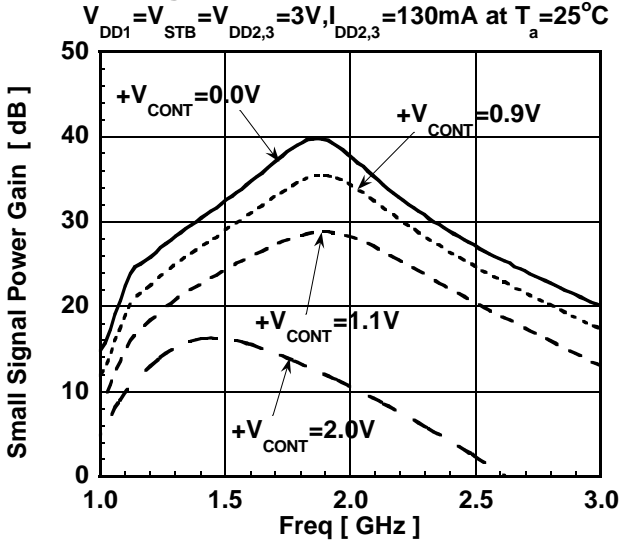

Small Signal Power Gain vs. Frequency

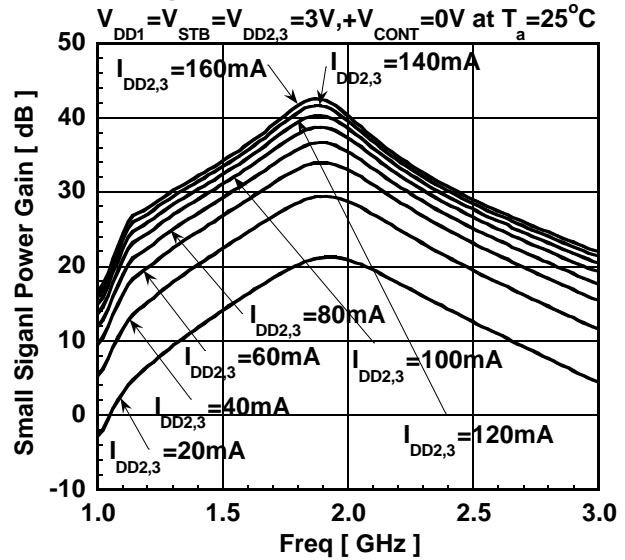

Input Return Loss vs. Frequency

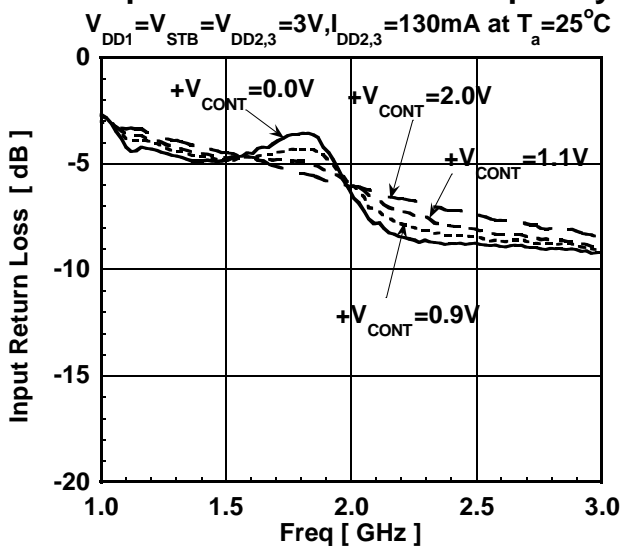

Output Return Loss vs. Frequency

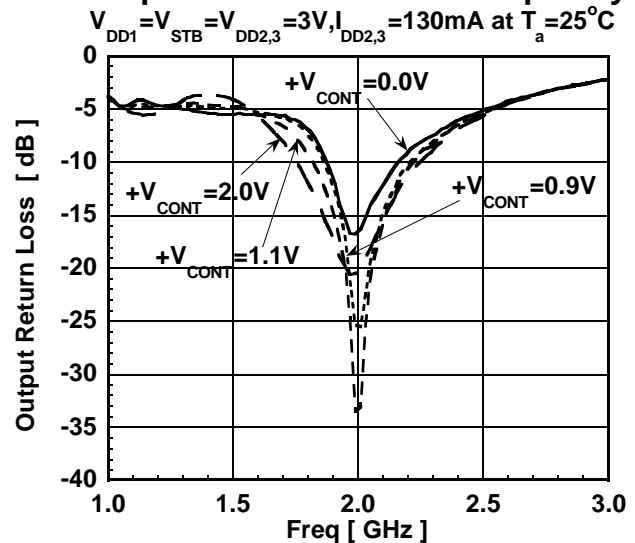

■ TYPICAL CHARACTERISTICS

Output Power, Gain vs. Input Power

$V_{DD1} = V_{STB} = V_{DD2,3} = 3V, I_{idle} = 130mA, f = 1.9GHz$ at $T_a = 25^\circ C$

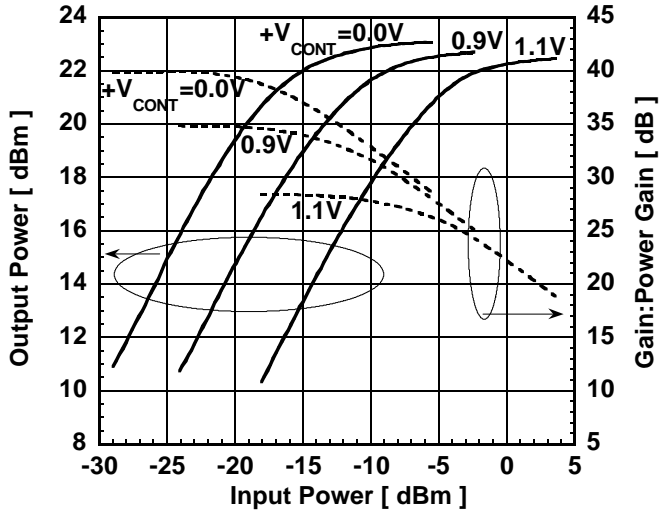

Output Power, Gain vs. Input Power

$V_{DD1} = V_{STB} = V_{DD2,3} = 3V, I_{idle} = 130mA, f = 1.765GHz$ at $T_a = 25^\circ C$

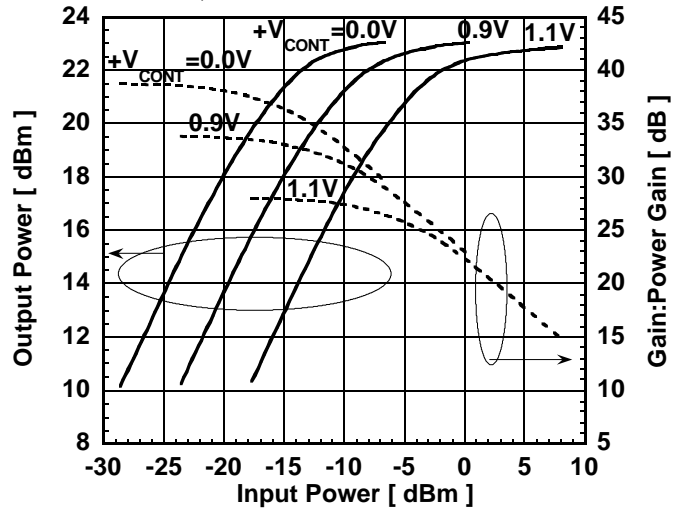

Output Power, I_{DD2,3} vs. Input Power

$V_{DD1} = V_{STB} = V_{DD2,3} = 3V, I_{idle} = 130mA, f = 1.9GHz$ at $T_a = 25^\circ C$

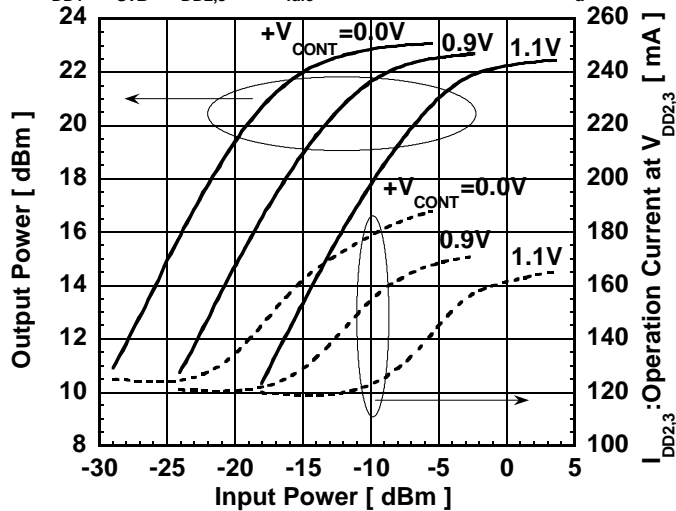

Output Power, I_{DD2,3} vs. Input Power

$V_{DD1} = V_{STB} = V_{DD2,3} = 3V, I_{idle} = 130mA, f = 1.765GHz$ at $T_a = 25^\circ C$

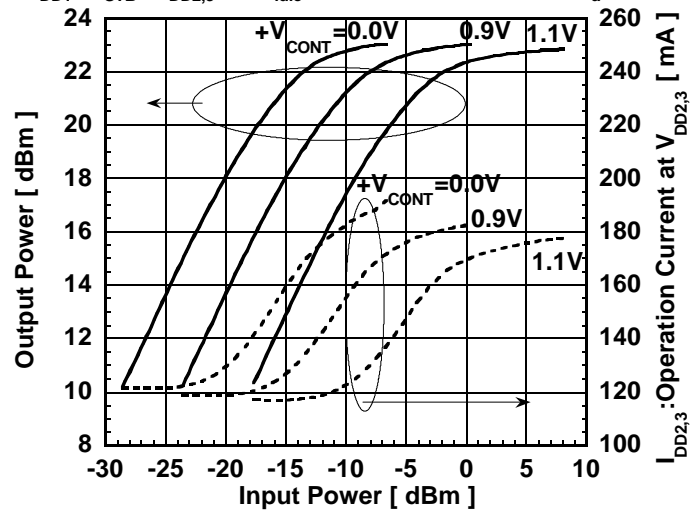

Output Power, PAE vs. Input Power

$V_{DD1} = V_{STB} = V_{DD2,3} = 3V, I_{idle} = 130mA, f = 1.9GHz$ at $T_a = 25^\circ C$

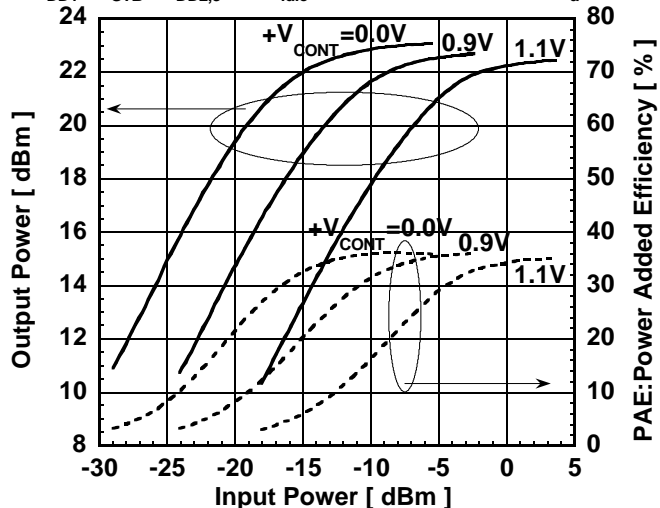

Output Power, PAE vs. Input Power

$V_{DD1} = V_{STB} = V_{DD2,3} = 3V, I_{idle} = 130mA, f = 1.765GHz$ at $T_a = 25^\circ C$

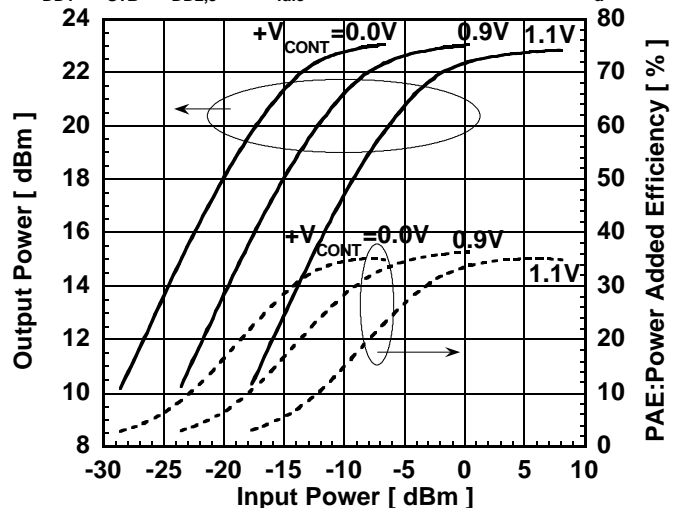

NJG1309VB2

TYPICAL CHARACTERISTICS

Gain, G_{CONT} vs. +V_{CONT}

$V_{DD1} = V_{STB} = V_{DD2,3} = 3V, I_{idle} = 130mA$
 $f = 1.9GHz, P_{out} = 21dBm$ at $T_a = 25^\circ C$

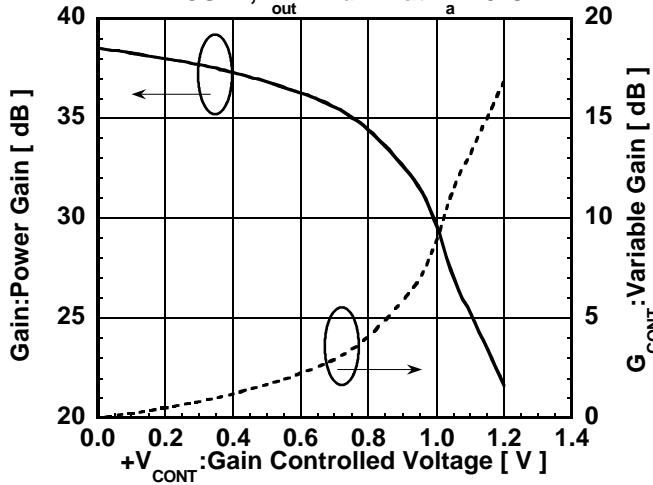

Gain, G_{CONT} vs. +V_{CONT}

$V_{DD1} = V_{STB} = V_{DD2,3} = 3V, I_{idle} = 130mA$
 $f = 1.765GHz, P_{out} = 21dBm$ at $T_a = 25^\circ C$

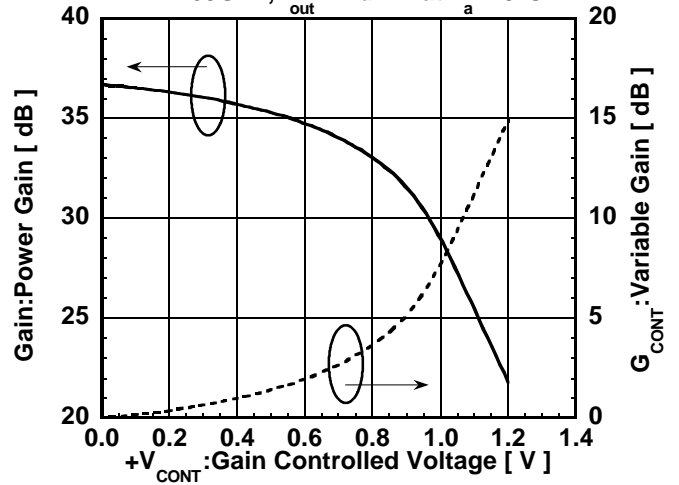

Gain vs. I_{idle}

$V_{DD1} = V_{STB} = V_{DD2,3} = 3.0V, +V_{CONT} = 0V$
 $f = 1.9GHz, P_{out} = 21dBm$ at $T_a = 25^\circ C$

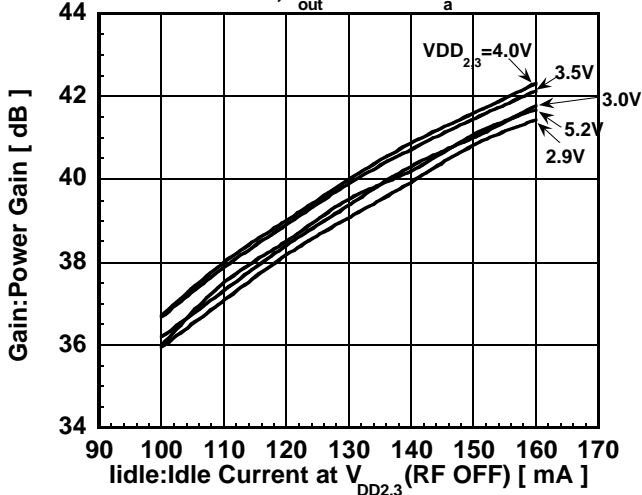

I_{DD2,3} vs. I_{idle}

$V_{DD1} = V_{STB} = V_{DD2,3} = 3.0V, +V_{CONT} = 0V$
 $f = 1.9GHz, P_{out} = 21dBm$ at $T_a = 25^\circ C$

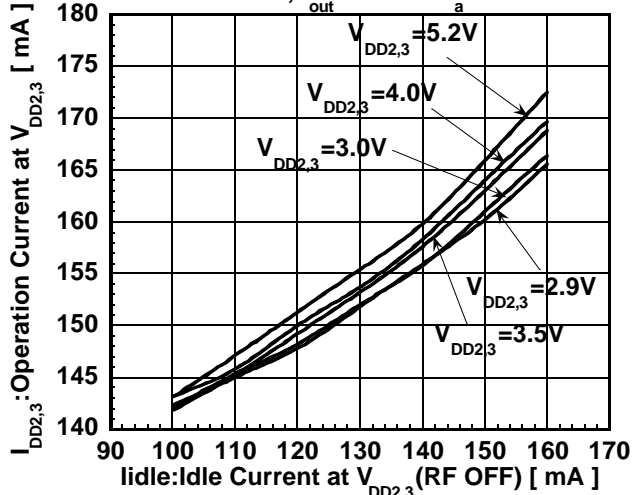

Gain, I_{DD2,3} vs. T_a

$V_{DD1} = V_{STB} = V_{DD2,3} = 3V, +V_{CONT} = 0V, I_{idle} = 130mA$
 $f = 1.9GHz, P_{out} = 21dBm$ at $T_a = 25^\circ C$

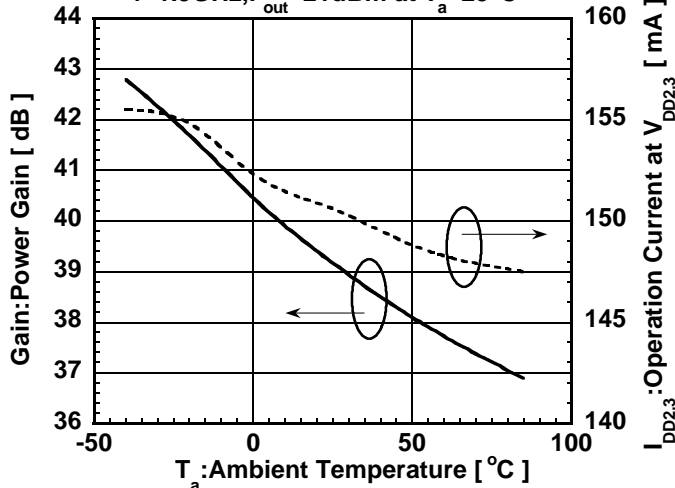

I_{DD1}, I_{GG} vs. T_a

$V_{DD1} = V_{STB} = V_{DD2,3} = 3V, +V_{CONT} = 0V, I_{idle} = 130mA$
 $f = 1.9GHz, P_{out} = 21dBm$ at $T_a = 25^\circ C$

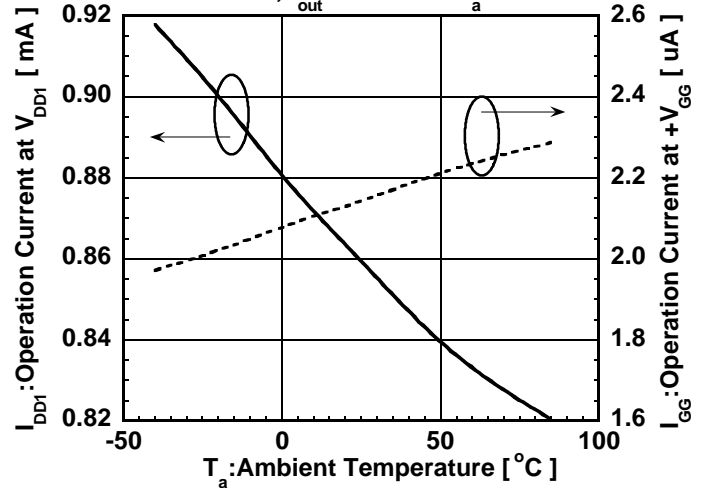

TYPICAL CHARACTERISTICS

Harmonics Spectrum

$V_{DD1}=V_{STB}=V_{DD2,3}=3V, I_{idle}=130mA$
 $+V_{CONT}=0V, freq=1.9GHz, P_{out}=21dB$

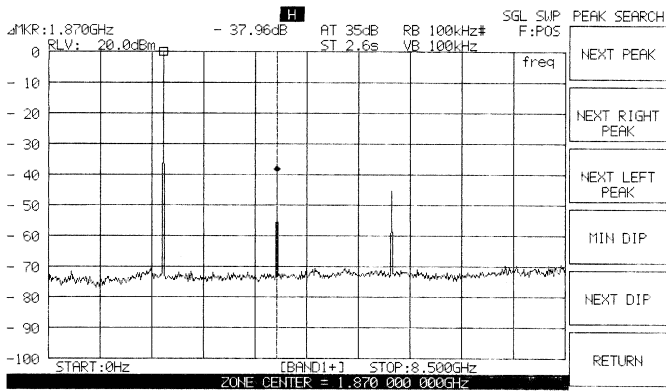

1.9GHz Band Spectrum

$V_{DD1}=V_{STB}=V_{DD2,3}=3V, I_{idle}=130mA$
 $+V_{CONT}=0V, freq=1.9GHz, P_{out}=21dB$

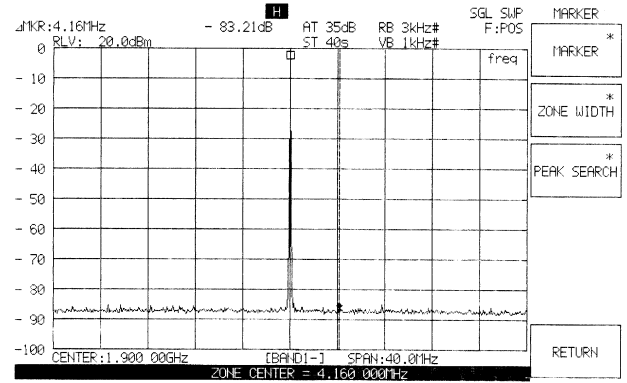

NJG1309VB2

■ TYPICAL CHARACTERISTICS

Scattering Parameters

$V_{DD1}=V_{STB}=V_{DD2,3}=3.0V$, $I_{DD2,3}=130mA$, $+V_{CONT}=0.0$

Freq [GHz]	S11		S21		S12		S22	
	MAG [units]	ANG [deg]	MAG [units]	ANG [deg]	MAG [units]	ANG [deg]	MAG [units]	ANG [deg]
1.00	0.735	-114.9	5.499	157.8	0.002	104.2	0.649	-136.0
1.10	0.618	-125.9	13.129	134.9	0.004	166.8	0.608	-138.6
1.20	0.610	-130.3	19.476	81.7	0.001	133.1	0.589	-151.2
1.30	0.586	-137.9	25.979	42.4	0.002	83.9	0.563	-161.6
1.40	0.572	-144.8	32.912	5.4	0.002	70.2	0.540	-171.2
1.50	0.575	-151.8	41.903	-29.3	0.002	38.5	0.530	178.1
1.60	0.594	-158.7	54.363	-64.9	0.002	107.3	0.535	165.0
1.70	0.636	-169.4	71.512	-103.8	0.003	38.4	0.526	143.8
1.71	0.638	-171.4	73.884	-108.3	0.003	49.1	0.526	141.1
1.72	0.645	-172.3	76.019	-112.4	0.003	24.6	0.512	138.5
1.73	0.645	-173.6	78.109	-116.9	0.003	11.5	0.506	136.1
1.74	0.648	-174.7	80.104	-121.7	0.003	2.1	0.508	133.2
1.75	0.657	-176.9	81.823	-126.1	0.002	52.9	0.502	129.7
1.76	0.656	-178.5	83.884	-130.9	0.002	45.6	0.495	125.9
1.77	0.662	-179.8	85.911	-135.8	0.003	42.1	0.488	122.5
1.78	0.664	178.0	88.234	-140.8	0.002	1.6	0.478	118.3
1.79	0.660	176.9	89.920	-145.9	0.002	51.2	0.463	114.0
1.80	0.667	175.1	91.778	-151.0	0.002	37.5	0.454	110.0
1.81	0.665	172.7	93.288	-155.9	0.003	-1.4	0.439	105.6
1.82	0.663	171.2	94.577	-161.4	0.002	11.6	0.427	101.1
1.83	0.664	168.5	96.237	-167.1	0.003	41.9	0.411	96.1
1.84	0.658	165.9	96.855	-172.6	0.004	52.9	0.389	90.9
1.85	0.658	165.0	97.531	-178.1	0.002	6.8	0.371	85.1
1.86	0.653	162.7	97.939	176.4	0.002	17.5	0.356	79.8
1.87	0.648	160.2	97.817	170.8	0.002	-42.0	0.328	73.5
1.88	0.626	159.8	97.308	165.2	0.004	40.7	0.319	68.7
1.89	0.617	157.2	96.672	159.7	0.002	-1.2	0.287	62.1
1.90	0.609	155.8	95.973	154.2	0.004	34.1	0.272	53.9
1.91	0.595	154.1	94.893	148.7	0.002	47.8	0.248	47.7
1.92	0.583	152.1	93.471	143.4	0.004	33.9	0.223	36.1
1.93	0.572	150.7	91.682	138.2	0.003	-30.6	0.198	31.2
1.94	0.550	149.8	90.112	133.0	0.004	40.4	0.181	16.7
1.95	0.545	148.5	88.018	128.1	0.004	-19.8	0.168	14.1
1.96	0.525	146.4	85.953	123.3	0.002	-68.3	0.161	-3.1
1.97	0.516	146.5	83.721	118.4	0.002	11.5	0.146	-14.2
1.98	0.503	145.3	81.424	113.7	0.002	0.2	0.139	-29.2
1.99	0.490	145.0	79.090	109.3	0.001	-8.6	0.145	-40.3
2.00	0.487	144.2	76.915	105.1	0.000	45.3	0.140	-53.7
2.10	0.401	142.4	57.086	67.2	0.001	-94.1	0.249	-116.5
2.20	0.375	139.2	43.451	37.2	0.002	-15.8	0.355	-143.7
2.30	0.364	135.5	34.273	10.6	0.002	-28.3	0.428	-162.0
2.40	0.364	131.2	27.648	-13.7	0.001	-1.2	0.500	-177.7
2.50	0.366	125.4	22.710	-36.2	0.002	6.3	0.551	169.4
2.60	0.361	118.5	19.114	-57.9	0.002	14.1	0.616	156.0
2.70	0.358	111.5	16.165	-79.1	0.001	-37.1	0.655	144.1
2.80	0.357	104.0	13.822	-99.5	0.004	-32.1	0.710	131.5
2.90	0.353	97.5	11.767	-119.5	0.003	-18.4	0.738	119.6
3.00	0.347	89.8	10.081	-139.0	0.004	3.4	0.778	107.4

RECOMMENDED CIRCUIT

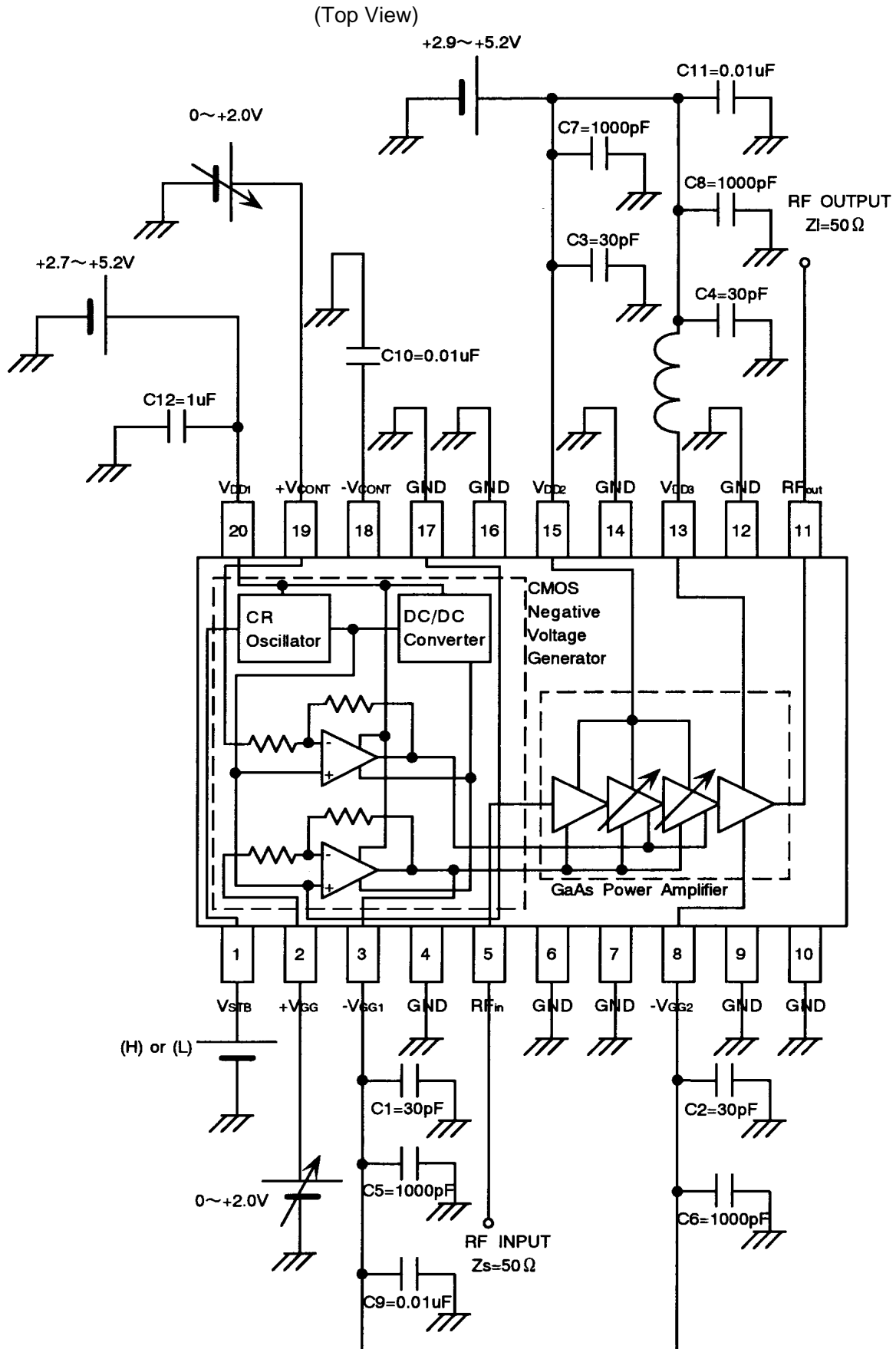

NJG1309VB2

RECOMMENDED PCB DESIGN

(Top View)

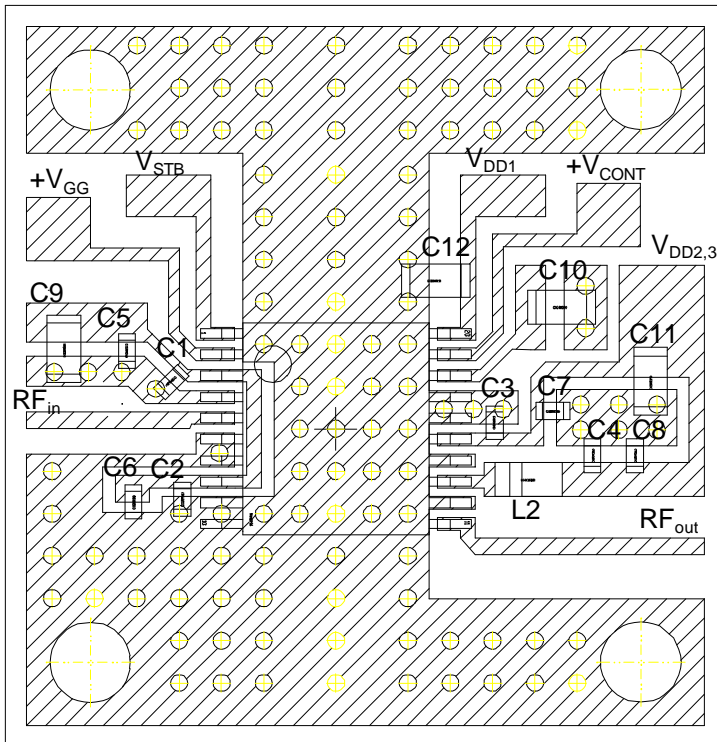

PCB

FR-4

t=0.2mm

PCB Size

17.5mmX17.0mm

Microstrip Line Width

w=0.4mm($Z_0=50\Omega$,

RFin and Rfout port)

Notes

[1] CMOS IC negative voltage generator has Internal CR oscillator, therefor to reduction of noise, decoupling capacitor(C12) should be connected between the 20pin and the GND.

[2] Chip parts as follows should be connected to the leads of IC as near as possible.

- (1) 3pin - C1
- (2) 8pin - C2
- (3) 13pin - L1
- (4) 15pin - C3

[3] Chip parts list

Parts ID	Constant	Note
C1~C4	30pF	MURATA GRM36 Series
C5~C8	1000pF	MURATA GRM36 Series
C9~C11	0.01uF	MURATA GRM39 Series
C12	1uF	MURATA GRM39 Series
L2	10nH	TAIYO-YUDEN HK1608

PACKAGE OUTLINE (SSOP20-B2)

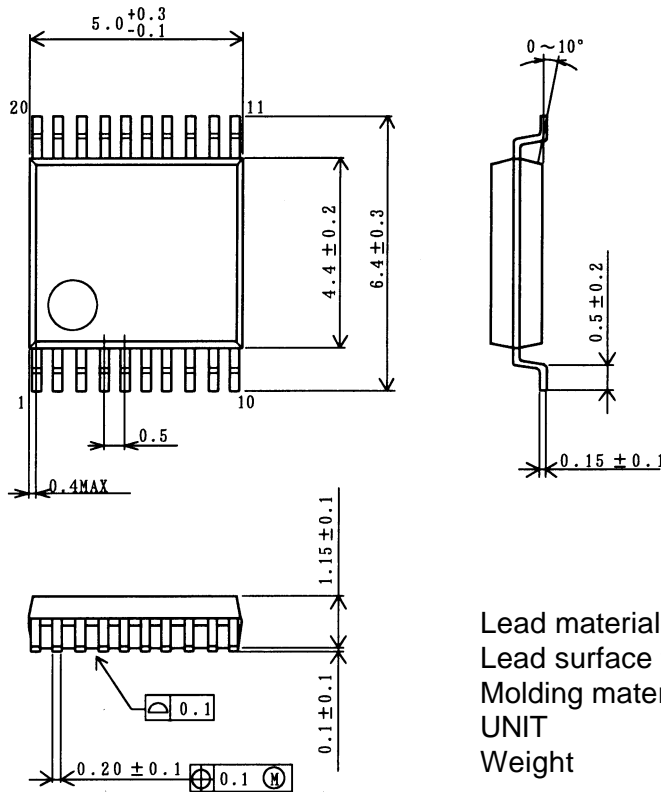

Lead material	: Copper
Lead surface finish	: Solder plating
Molding material	: Epoxy resin
UNIT	: mm
Weight	: 66mg

Cautions on using this product

This product contains Gallium-Arsenide (GaAs) which is a harmful material.

- Do NOT eat or put into mouth.
- Do NOT dispose in fire or break up this product.
- Do NOT chemically make gas or powder with this product.
- To waste this product, please obey the relating law of your country.

[CAUTION]

The specifications on this databook are only given for information, without any guarantee as regards either mistakes or omissions. The application circuits in this databook are described only to show representative usages of the product and not intended for the guarantee or permission of any right including the industrial rights.

This product may be damaged with electric static discharge (ESD) or spike voltage. Please handle with care to avoid these damages.