

DIGITAL OUTPUT PHOTO REFLECTOR

GENERAL DESCRIPTION

The NJL5801K is thin package digital output type photo reflector which consist of New JRC original designed one chip photo receiving IC and high output LED.

FEATURES

- Normally on type
- With schmitt trigger circuit
- TTL Compatible
- Built-in visible light cut-off filter.

APPLICATIONS

- Tape end sensor
- Reel rotation sensor
- Paper detector, Paper end sensor
- Bar code reader
- Sensor of FDD, Robot, manufacturing installation, etc.

OUTLINE (typ.) Unit: mm

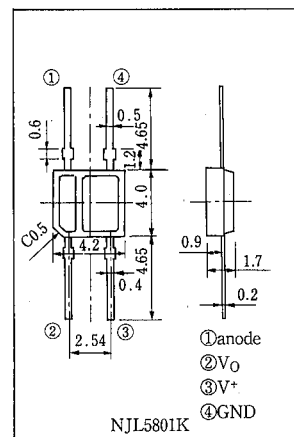

ABSOLUTE MAXIMUM RATINGS (T_a=25°C)

PARAMETER	SYMBOL	RATINGS	UNIT
Emitter			
Forward Current (Continuous)	I _F	50	mA
Reverse Voltage (Continuous)	V _R	6	V
Power Dissipation	P _D	75	mW
Detector			
Supply Voltage	V ⁺	16	V
High Level Output Voltage	V _{OH}	16	V
Low Level Output Current	I _{OL}	50	mA
Power Dissipation	P _O	110	mW
Coupler			
Total Power Dissipation	P _{tot}	130	mW
Operating Temperature	T _{opr}	-20~+85	°C
Storage Temperature	T _{stg}	-30~+100	°C
Soldering Temperature	T _{sol}	260	°C
		(5sec. 1.5mm from body)	

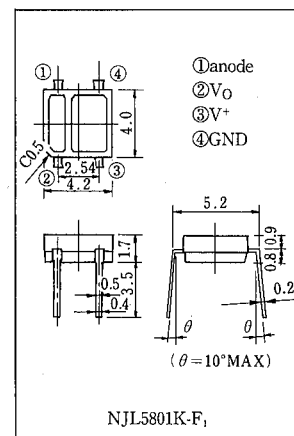

BLOCK DIAGRAM

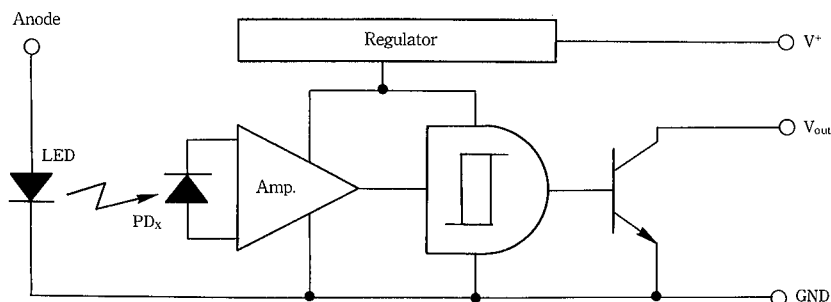

■ ELECTRO-OPTICAL CHARACTERISTICS (Ta=25°C)

PARAMETER	SYMBOL	TEST CONDITION	MIN.	TYP.	MAX.	UNIT
Emitter						
Forward Voltage	V_F	$I_F = 10\text{mA}$	—	1.1	1.3	V
Reverse Current	I_R	$V_R = 6\text{V}$	—	—	1.0	μA
Capacitance	C_t	$V_R = 0\text{V}, f = 1\text{MHz}$	—	25	—	pF
Detector						
Supply Voltage Range	V^+		3.5	—	15	V
Low Level Output Voltage	V_{OL}	$I_{OL} = 16\text{mA}, V^+ = 5\text{V}, I_F = 0\text{mA}$	—	0.2	0.5	V
High Level Output Current	I_{OH}	$V_O = V^+ = 15\text{V}, I_F = 10\text{mA}, d = 0.7\text{mm}$	—	—	100	μA
Low Level Supply Current	I_{CCL}	$V^+ = 5\text{V}, I_F = 0\text{mA}$	—	4.5	10	mA
High Level Supply Current	I_{CCH}	$V^+ = 5\text{V}, I_F = 10\text{mA}, d = 0.7\text{mm}$	—	3	10	mA
Coupled						
L→H Threshold Input Current	I_{FLH}	$V^+ = 5\text{V}, R_L = 280\Omega, d = 0.7\text{mm}$	—	—	10	mA
Hysteresis	I_{FHL}/I_{FLH}	$V^+ = 5\text{V}, R_L = 280\Omega, d = 0.7\text{mm}$	—	0.8	—	
L→H Delay Time	t_{PLH}	$V^+ = 5\text{V}, R_L = 280\Omega, I_F = 10\text{mA}, d = 0.7\text{mm}$	—	10	—	μs
H→L Delay Time	t_{PHL}	$V^+ = 5\text{V}, R_L = 280\Omega, I_F = 10\text{mA}, d = 0.7\text{mm}$	—	5	—	μs
Rise Time	t_r	$V^+ = 5\text{V}, R_L = 280\Omega, I_F = 10\text{mA}, d = 0.7\text{mm}$	—	0.1	—	μs
Fall Time	t_f	$V^+ = 5\text{V}, R_L = 280\Omega, I_F = 10\text{mA}, d = 0.7\text{mm}$	—	0.1	—	μs

■ MEASURING SPECIFICATION FOR THRESHOLD INPUT CURRENT

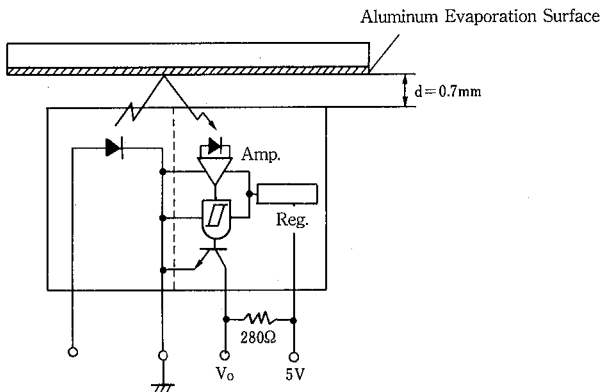

■ MAXIMUM RATING CURVES

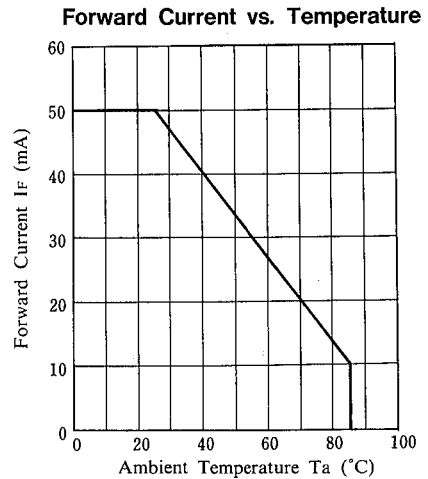
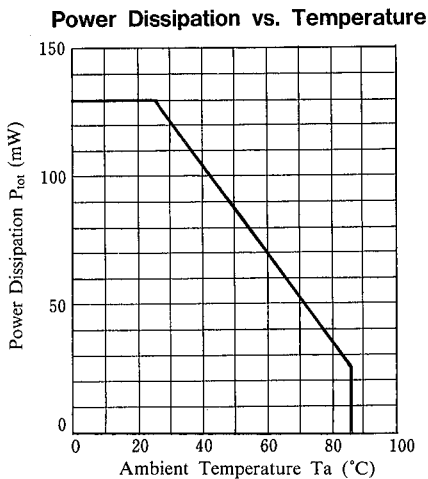

TYPICAL CHARACTERISTICS

Forward Current vs. Forward Voltage

($T_a = 85^\circ\text{C}, 50^\circ\text{C}, 25^\circ\text{C}, 0^\circ\text{C}, -20^\circ\text{C}$)

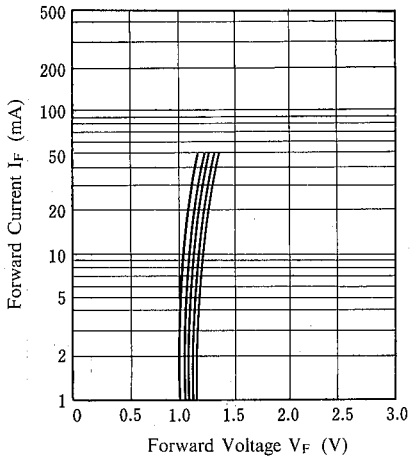

Input Threshold Current vs. Supply Voltage

($T_a = 25^\circ\text{C}$)

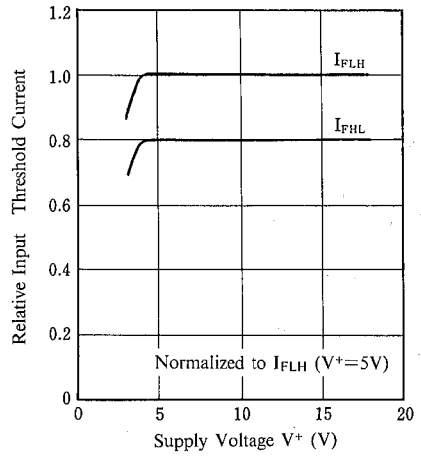

Input Threshold Current vs. Temperature

($V^+ = 5\text{V}$)

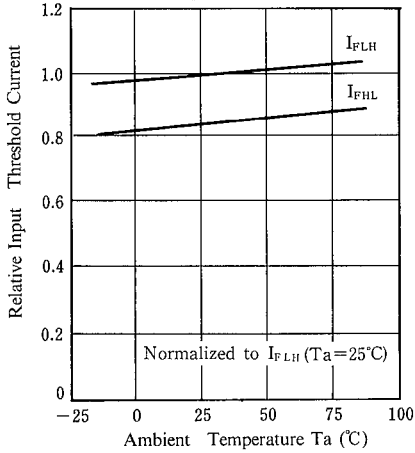

Low Level Output Voltage vs. Low Level Output Current

($V^+ = 5\text{V}, T_a = 25^\circ\text{C}$)

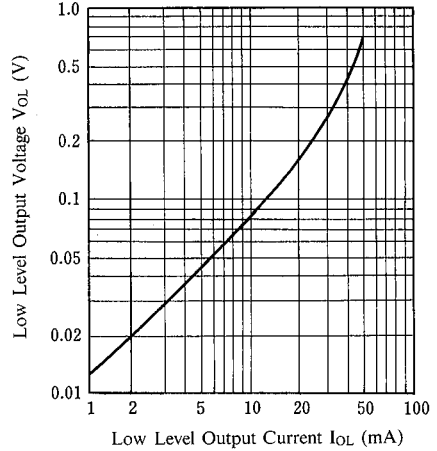

Low Level Output Voltage vs. Temperature

($V^+ = 5\text{V}$)

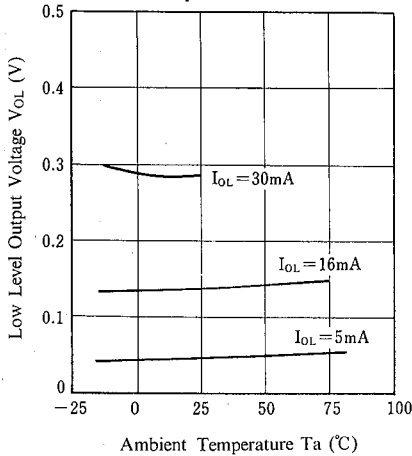

Supply Current vs. Supply Voltage

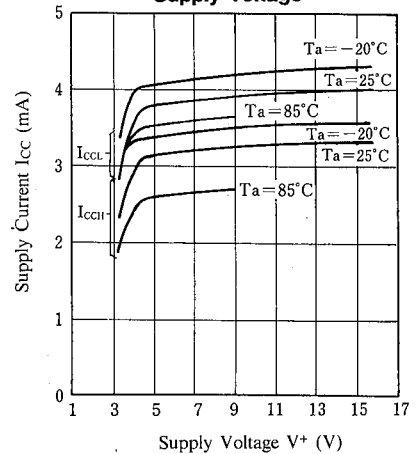

Delay Time vs. Forward Current

($V^+=5V$, $R_L=280\Omega$, $T_a=25^\circ C$)

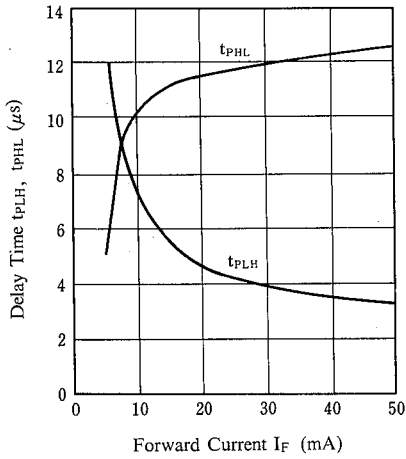

Switching Time vs. Resistance

($V^+=5V$, $I_F=10mA$, $T_a=25^\circ C$)

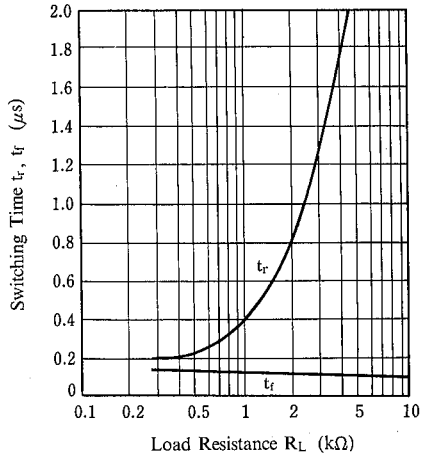

Input Threshold Current vs. Distance

($V^+=5V$, $R_L=280\Omega$, $T_a=25^\circ C$)

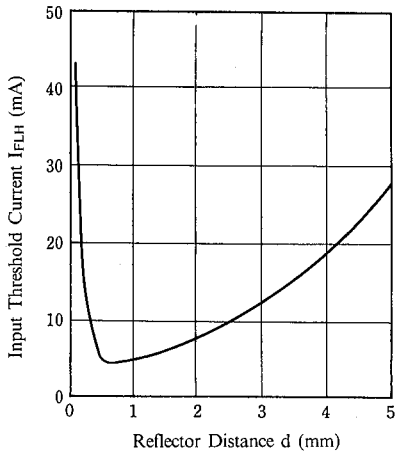

Measuring Circuit for Response Time

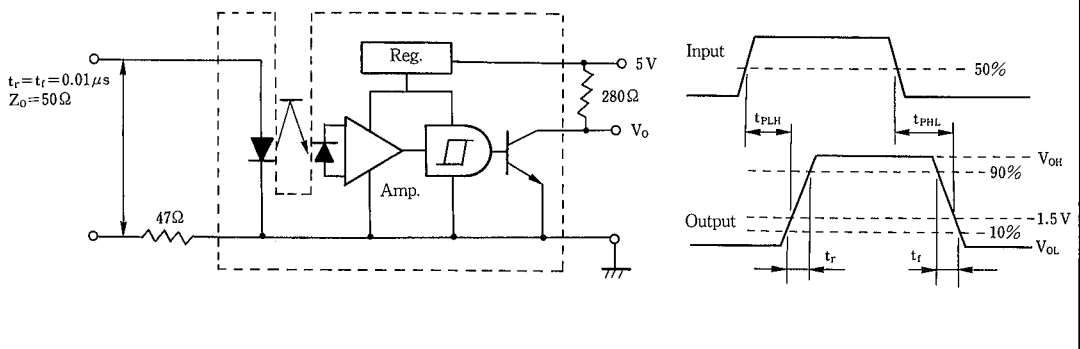

MEMO

[CAUTION]

The specifications on this databook are only given for information, without any guarantee as regards either mistakes or omissions. The application circuits in this databook are described only to show representative usages of the product and not intended for the guarantee or permission of any right including the industrial rights.