

## HIGH SPEED PIN PHOTO DIODE

### ■ GENERAL DESCRIPTION

The NJL6201R-1 is the high speed PIN photo-diode that attained the short tail performance and the fast response (tr/ta) required of the laser diode power monitor of optical storage devices.

### ■ FEATURES

- Short tail performance
- Fast rise-time/fall-time  
5ns at 1-99%, VR=2.5V, λ=780nm/650nm
- High speed  
300MHz at λ=780nm  
300MHz at λ=650nm
- Miniature, thin type  
1.8mmX3.6mmX1.16mm

### ■ OUTLINE (typ.) Unit : mm

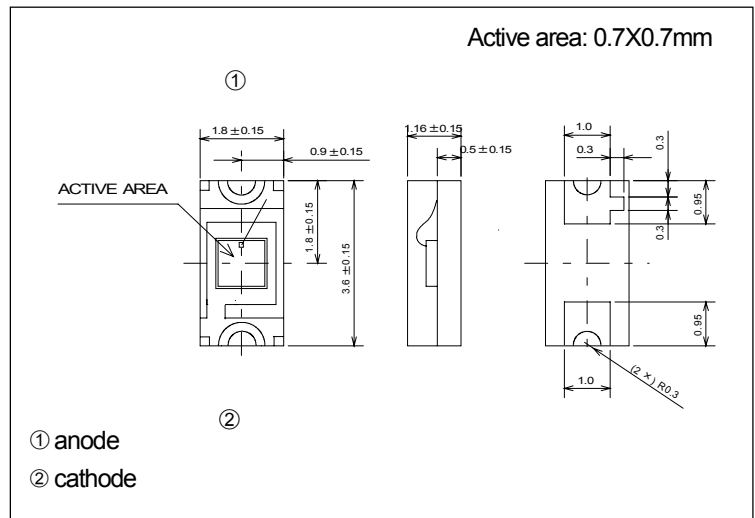

### ■ APPLICATIONS

- Front laser power monitor for CD-R/RW, DVD+/-R/RW/-RAM, recordable MD etc.

### ■ ABSOLUTE MAXIMUM RATINGS (Ta=25°C)

| PARAMETER                    | SYMBOL | RATINGS     | UNIT |
|------------------------------|--------|-------------|------|
| Reverse Voltage              | VR     | 35          | V    |
| Operating Temperature        | Topr   | -30 to +85  | °C   |
| Storage Temperature          | Tstg   | -40 to +100 | °C   |
| Reflow Soldering Temperature | Tsol   | 260         | °C   |

### ■ ELECTRO-OPTICAL CHARACTERISTICS (Ta=25°C)

| PARAMETER           | SYMBOL | TEST CONDITION                 | MIN  | TYP  | MAX | UNIT |
|---------------------|--------|--------------------------------|------|------|-----|------|
| Dark Current        | ID     | VR=10V                         | —    | 0.1  | 2.0 | nA   |
| Forward Voltage     | VF     | IF=1mA                         | —    | —    | 1.0 | V    |
| Capacitance         | Ct     | VR=2.5V, f=1MHz                | —    | 8    | —   | pF   |
| Peak Wavelength     | λP     | —                              | —    | 800  | —   | nm   |
| Sensitivity         | S      | VR=2.5V, λ=780nm               | 0.38 | 0.47 | —   | AW   |
|                     |        | VR=2.5V, λ=650nm               | 0.32 | 0.37 | —   | AW   |
| Rise time/Fall time | tr/ta  | VR=2.5V, λ=780nm, 1-99%        | —    | 5    | —   | ns   |
|                     |        | VR=2.5V, λ=650nm, 1-99%        | —    | 5    | —   | ns   |
| Cut off Frequency   | fc     | VR=2.5V, λ=780nm, RL=50Ω, -3dB | —    | 300  | —   | MHz  |
|                     |        | VR=2.5V, λ=650nm, RL=50Ω, -3dB | —    | 300  | —   | MHz  |

# NJL6201R-1

www.DataSheet4U.com

## TYPICAL CHARACTERISTICS

Light Current vs. Illuminance (Ta=25°C)

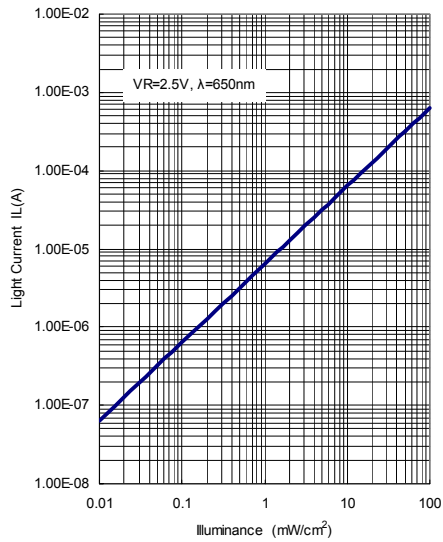

Spectral Response (Ta=25°C)

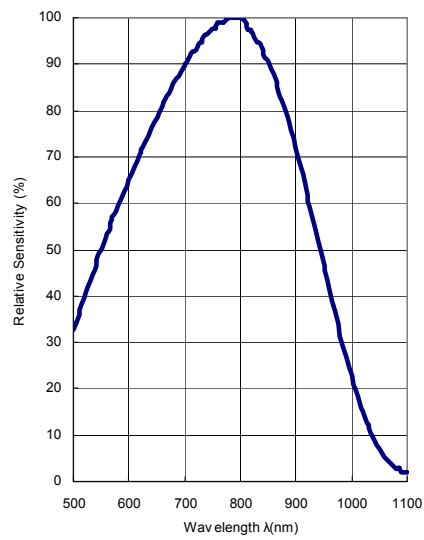

Dark Current vs. Temperature

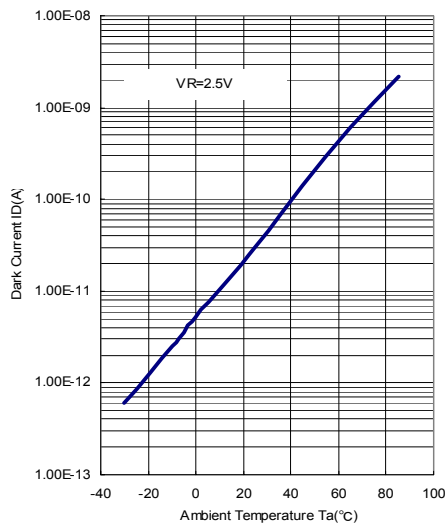

Relative Sensitivity vs. Temperature

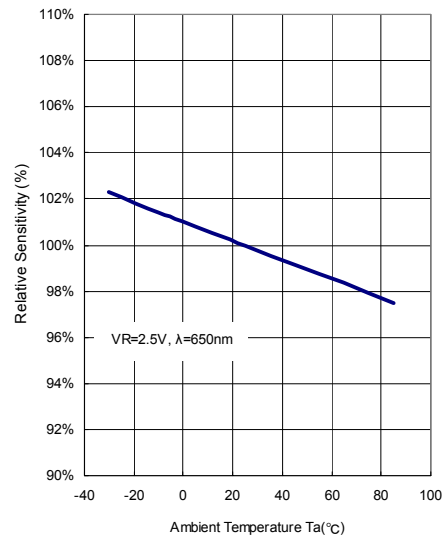

Rise Time vs. Reverse Voltage (Ta=25°C)

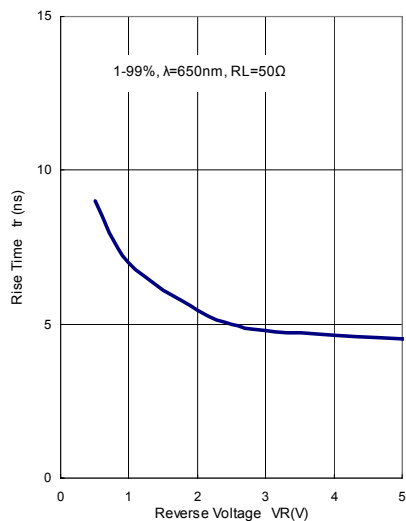

Fall Time vs. Reverse Voltage (Ta=25°C)

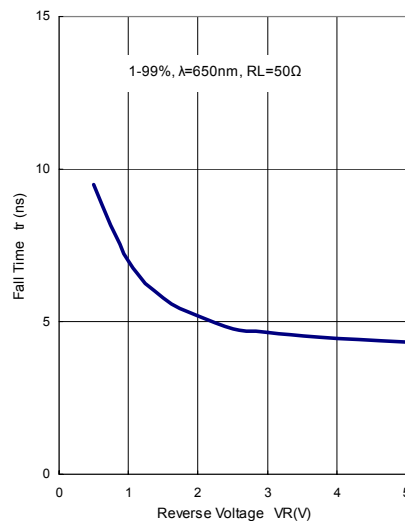

Relative Sensitivity vs. Frequency (Ta=25°C)

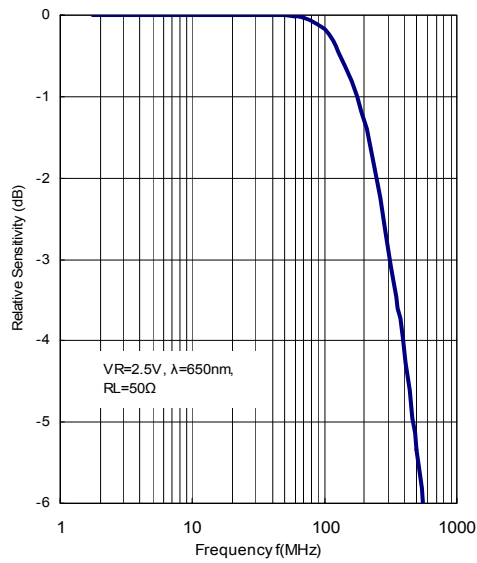

Capacitance vs. Reverse Voltage (Ta=25°C)

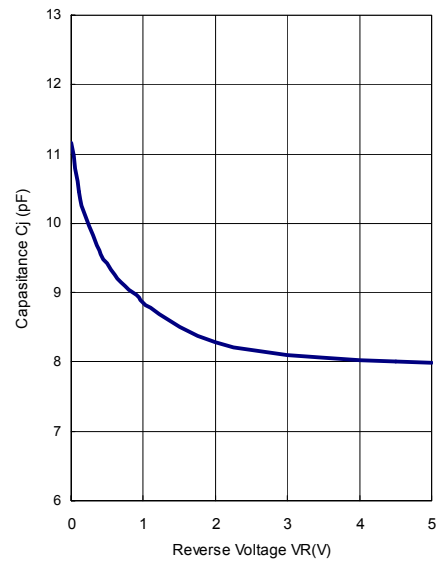

## MEASURING CIRCUIT FOR RESPONSE TIME

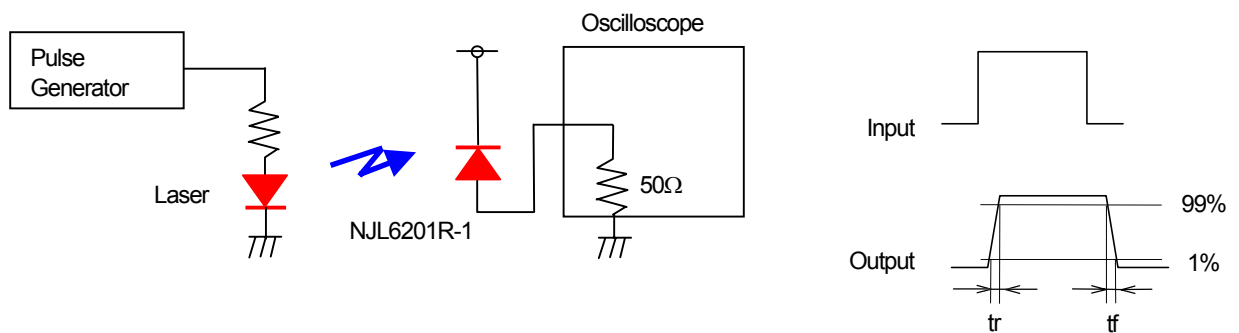

## PRECAUTION FOR HANDLING

### 1. Soldering to actual circuit board

#### Soldering condition

- Heated condition of plastic package.
- Lower than 260 °C of maximum surface temperature

#### Soldering Method

##### 1) Reflow Method

- Recommended temperature profile of its method.
- Soldering to be done within twice under this condition.

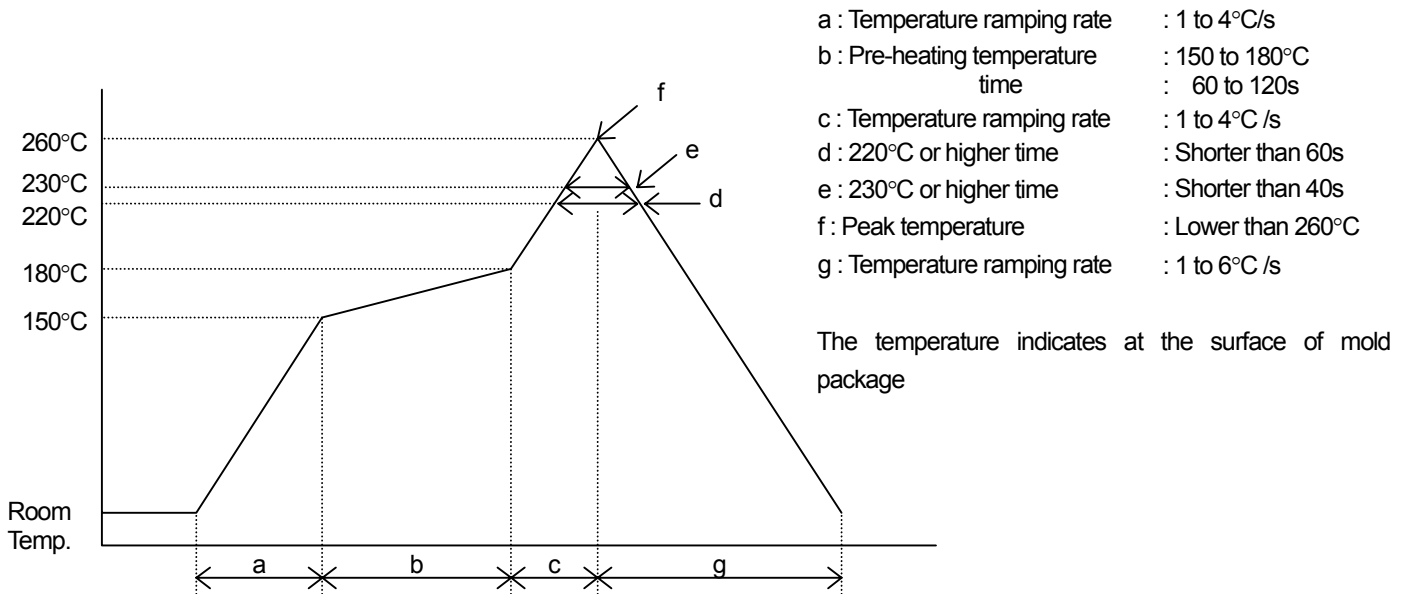

##### 2) Reflow Method (In case of infrared heating)

- Temperature profile : Same to the above
- Avoid direct irradiation to the plastic package because it is mold resin, absorbs the Infrared Radiation and its surface temperature will be higher than lead itself.

##### 3) The other method

- Avoid rapid heating up like dipping the devices directly into the melting solder or vapor phase method ( VPS).
- If the device is heated to high temperature and kept in its condition for longer time, it would affect to its reliability.
- It is necessary to solder in short time as soon as possible.

### 2. Cleaning

Avoid washing of the device after soldering by reflow method.

### 3. Attention in handling

- 1) Treat not to touch the lens surface.
- 2) Avoid dust and any other foreign materials (paint, bonding material, etc.) on the lens surface.

### 4. Storage

In order to prevent from degradation of this device in moisturing at reflow method, so that this device is contained in deaeration packaging. So that mount the device as short as possible after opening the envelope.

## NJL6201R-1 Taping Specification

### 1. Taping Size

- 1) Carrier tape is used with Styrene type Carbonated Plastic.
- 2) Cover tape is used with electro statistically prevention treated Polyester type tape.
- 3) Product taping direction is to place the index mark against the pull out direction of the tape as in the drawing.

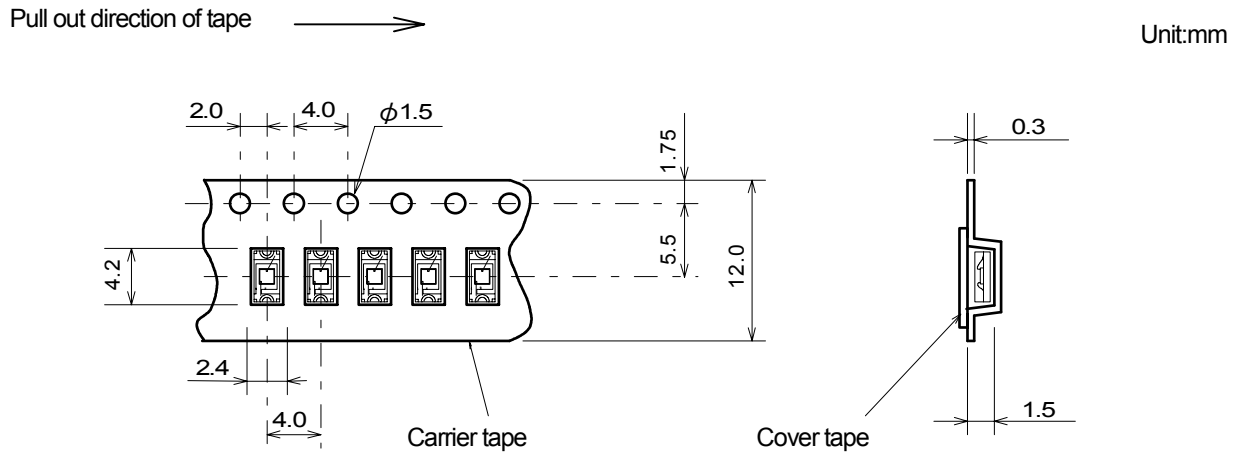

### 2. Taping Strength

Pull up the cover tape from the carrier tape, and when the opening angle comes around 10 to 15°, and the peeling-off strength is to be within the power of 20 to 70g.

### 3. Packaging

- 1) The taped products are to be rolled up on the taping reel as on the drawing.
- 2) Rolling up specification
  - 2-1) Start Rolling : Carrier tape open space more than 20 Pieces.
  - 2-2) End of Rolling : Carrier tape open space more than 20 Pieces, and 2 round of reel space at the cover tape only.
- 3) Taping quantity : 2,000 Pieces
- 4) Seal off after putting each reels in a dampproof bag with silica gel (3 bags).

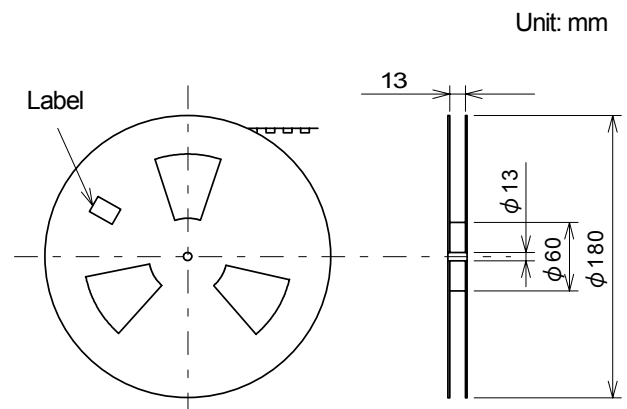

# NJL6201R-1

www.DataSheet4U.com

## MEMO

**[CAUTION]**

The specifications on this databook are only given for information, without any guarantee as regards either mistakes or omissions. The application circuits in this databook are described only to show representative usages of the product and not intended for the guarantee or permission of any right including the industrial rights.