

## LDO with Reverse Current Protection / Soft Start / Discharge Function

### ■ GENERAL DESCRIPTION

The NJM12856 is a low dropout regulator which achieves high ripple rejection, low noise and high speed response with the bipolar technology.

Adjustable soft-start function is useful for reducing inrush current and controlling power-on sequence. Moreover the discharge function makes effective sequence control with the soft-start function.

In addition, the reverse current protection makes external SBD unnecessary.

### ■ PACKAGE OUTLINE

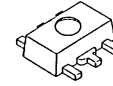

NJM12856U2

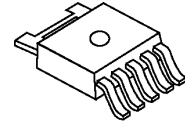

NJM12856DL3

### ■ FEATURE

- Operating Voltage Range    2.5V ~ 6.5V
- Output Voltage Accuracy     $V_O \pm 1.0\%$
- Output Current                 $I_O(\text{min.})=1000\text{mA}$
- Reverse Current Protection
- Adjustable soft-start Function
- Discharge Function
- ON/OFF Control
- Correspond to Low ESR capacitor (MLCC)
- Thermal Shutdown Circuit
- Over Current Protection Circuit
- Package Outline                SOT-89-5, TO-252-5

### ■ PIN CONFIGURATION

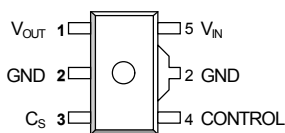

NJM12856U2

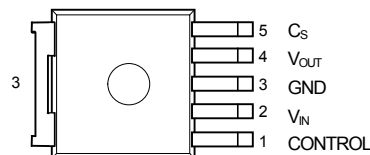

NJM12856DL3

### ■ BLOCK DIAGRAM

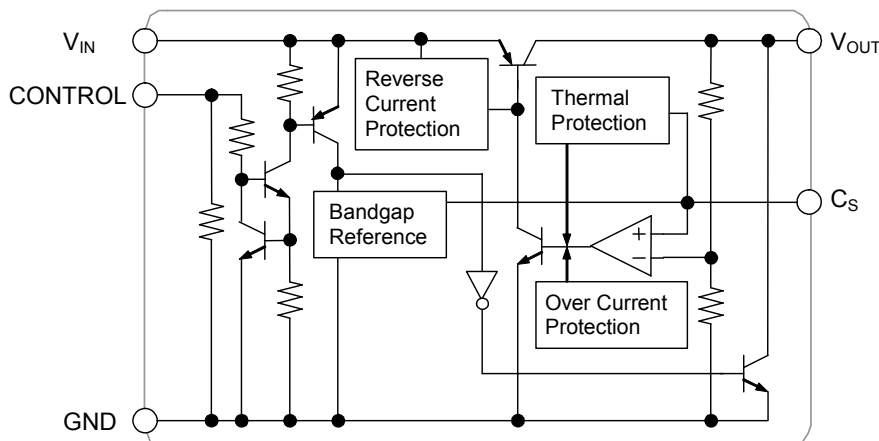

# NJM12856

## ■ OUTPUT VOLTAGE RANK LIST

SOT-89-5

TO-252-5

Device Name	Output Voltage	Device Name	Output Voltage
NJM12856U2-15	1.5V	NJM12856DL3-15	1.5V
NJM12856U2-18	1.8V	NJM12856DL3-18	1.8V
NJM12856U2-25	2.5V	NJM12856DL3-25	2.5V
NJM12856U2-33	3.3V	NJM12856DL3-33	3.3V
NJM12856U2-05	5.0V	NJM12856DL3-05	5.0V

## ■ ABSOLUTE MAXIMUM RATINGS

(Ta=25°C)

PARAMETER	SYMBOL	MAXIMUM RATING	UNIT
Input Voltage	V <sub>IN</sub>	-0.3 ~ +7	V
Control Pin Voltage	V <sub>CONT</sub>	-0.3 ~ +7	V
Output Voltage	V <sub>OUT</sub>	V <sub>o</sub> ≤1.8V	-0.3 ~ +5.5
		V <sub>o</sub> >1.8V	-0.3 ~ +7
Soft start Pin Voltage	V <sub>CS</sub>	-0.3 ~ +2.5	V
Power Dissipation	P <sub>D</sub>	SOT-89-5	625(*1)
			2400(*2)
		TO-252-5	1190(*1)
			3125(*2)
			mW
Junction Temperature Range	T <sub>j</sub>	-40 ~ +150	°C
Operating Temperature Range	T <sub>opr</sub>	-40 ~ +125	°C
Storage Temperature Range	T <sub>stg</sub>	-50 ~ +150	°C

(\*1): Mounted on glass epoxy board. (76.2 × 114.3 × 1.6mm:based on EIA/JDEC standard size, 2Layers, Cu area 100mm<sup>2</sup>)

(\*2): Mounted on glass epoxy board. (76.2 × 114.3 × 1.6mm:based on EIA/JDEC standard, 4Layers)

(For 4Layers: Applying 74.2 × 74.2mm inner Cu area and a thermal via hole to a board based on JEDEC standard JESD51-5)

■ Operating Voltage Range : V<sub>IN</sub>=2.5V ~ 6.5V

## ■ ELECTRICAL CHARACTERISTICS

(Unless other noted,

$V_{IN} = V_O + 1V$ ,  $C_{IN} = 0.33\mu F$ ,  $C_O = 0.47\mu F$  ( $C_O = 1.0\mu F : 2.4V < V_O \leq 2.9V$ ,  $C_O = 2.2\mu F : 1.7V < V_O \leq 2.4V$ ,  $C_O = 4.7\mu F : V_O \leq 1.7V$ ),  $C_S = 0.01\mu F$ ,  $T_a = 25^\circ C$ )

PARAMETER	SYMBOL	TEST CONDITION	MIN.	TYP.	MAX.	UNIT	
Output Voltage	$V_O$	$I_O = 200mA$	-1.0%	-	+1.0%	V	
Quiescent Current	$I_Q$	$I_O = 0mA$ , except $I_{CONT}$	-	400	600	$\mu A$	
Quiescent Current at OFF-state	$I_{Q(OFF)}$	$V_{CONT} = 0V$	-	-	10	$\mu A$	
Output Current	$I_O$	$V_O \times 0.9$	1000	-	-	mA	
Line Regulation	$\Delta V_O / \Delta V_{IN}$	$V_{IN} = V_O + 1V \sim 6.5V$ , $I_O = 200mA$	-	-	0.15	%/V	
Load Regulation	$\Delta V_O / \Delta I_O$	$I_O = 0 \sim 1000mA$	-	-	0.003	%/mA	
Dropout Voltage (*3)	$\Delta V_{IO}$	$I_O = 600mA$	-	0.20	0.28	V	
Average Temperature Coefficient of Output Voltage	$\Delta V_O / \Delta T_a$	$T_a = -40 \sim +125^\circ C$ , $I_O = 200mA$	-	$\pm 50$	-	ppm/ $^\circ C$	
Ripple Rejection	RR	$V_{IN} = 3.0V$ $e_{in} = 200mV_{rms}$ , $f = 1kHz$ , $I_O = 10mA$	$V_O = 1.5V$	-	78	-	dB
			$V_O = 1.8V$	-	76	-	
		$e_{in} = 200mV_{rms}$ , $f = 1kHz$ , $I_O = 10mA$	$V_O = 2.5V$	-	73	-	
			$V_O = 3.3V$	-	72	-	
			$V_O = 5.0V$	-	68	-	
Output Noise Voltage	$V_{NO}$	$f = 10Hz \sim 80kHz$ , $I_O = 10mA$	$V_O = 1.5V$	-	17	-	$\mu V_{rms}$
			$V_O = 1.8V$	-	19	-	
			$V_O = 2.5V$	-	24	-	
			$V_O = 3.3V$	-	30	-	
			$V_O = 5.0V$	-	42	-	
Control Current	$I_{CONT}$	$V_{CONT} = 1.6V$	-	3	12	$\mu A$	
Control Voltage at ON-state	$V_{CONT(ON)}$		1.6	-	-	V	
Control Voltage at OFF-state	$V_{CONT(OFF)}$		-	-	0.6	V	
Soft Start Time	$t_{S(ON)}$	$V_{CONT} = L \rightarrow H$ , $I_O = 200mA$ , $C_S = 0.022\mu F$	-	1.2	-	msec	
Discharge Current at OFF-state	$I_{DIS}$	$V_{IN} = 2.5V$ , $V_{CONT} = 0V$ , $V_O = 0.5V$	3	10		mA	
		$V_{IN} = 6.5V$ , $V_{CONT} = 0V$ , $V_O = 0.5V$	15	25			

(\*3): Except Output Voltage Rank less than 2.2V

The above specification is a common specification for all output voltages.

Therefore, it may be different from the individual specification for a specific output voltage.

# NJM12856

## POWER DISSIPATION vs. AMBIENT TEMPERATURE

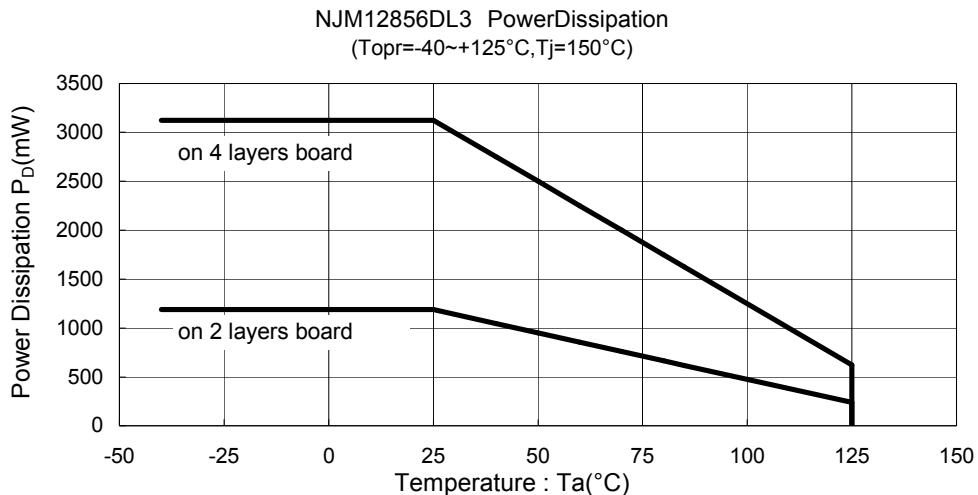
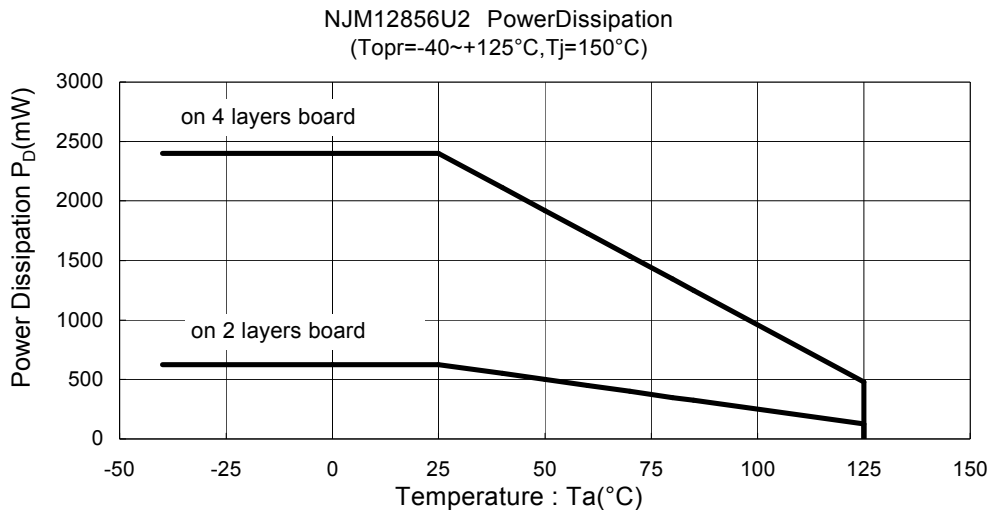

## TEST CIRCUIT

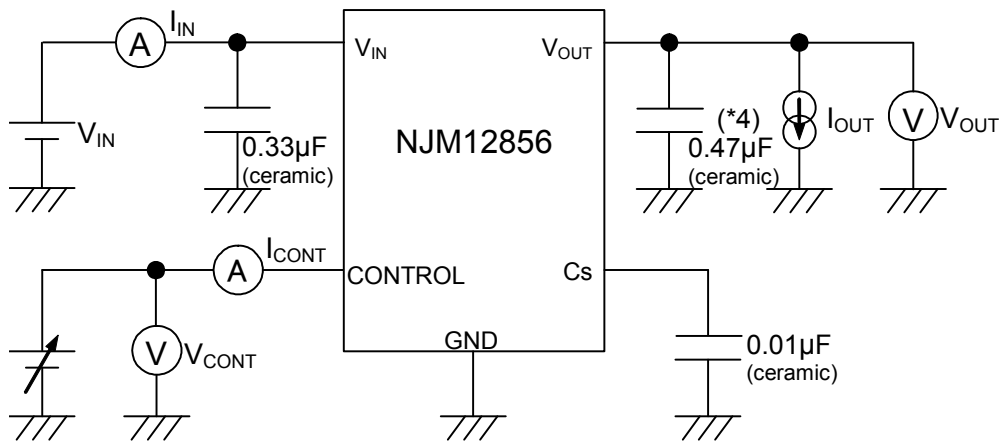

\*4: 2.4V <  $V_o$  ≤ 2.9V version:  $C_o=1.0\mu\text{F}$ (Ceramic)  
 1.7V <  $V_o$  ≤ 2.4V version:  $C_o=2.2\mu\text{F}$ (Ceramic)  
 $V_o \leq 1.7\text{V}$  version:  $C_o=4.7\mu\text{F}$ (Ceramic)

## ■ TYPICAL APPLICATION

1. In the case where ON/OFF Control is not required

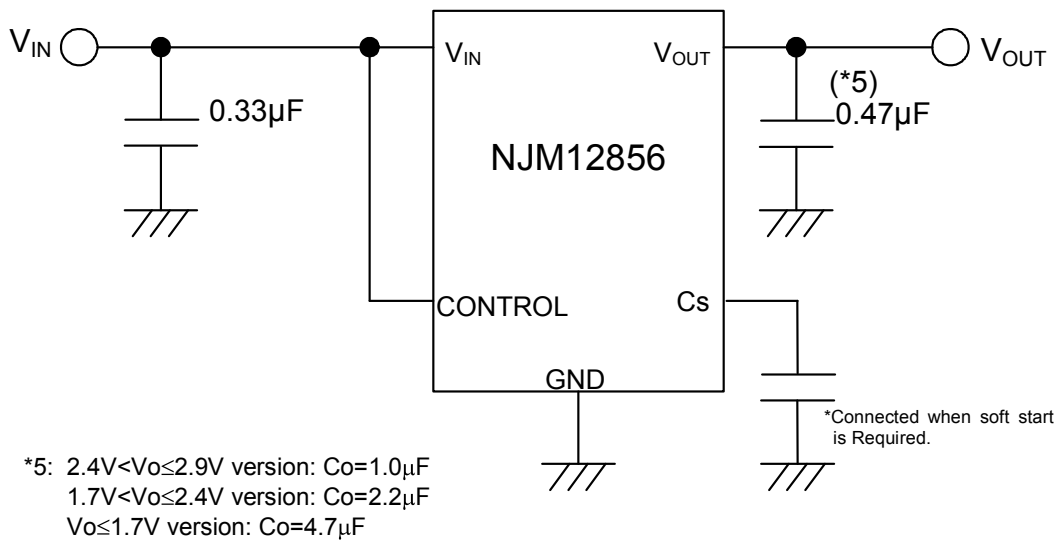

Connect CONTROL Pin to  $V_{IN}$  Pin

2. In use of ON/OFF CONTROL

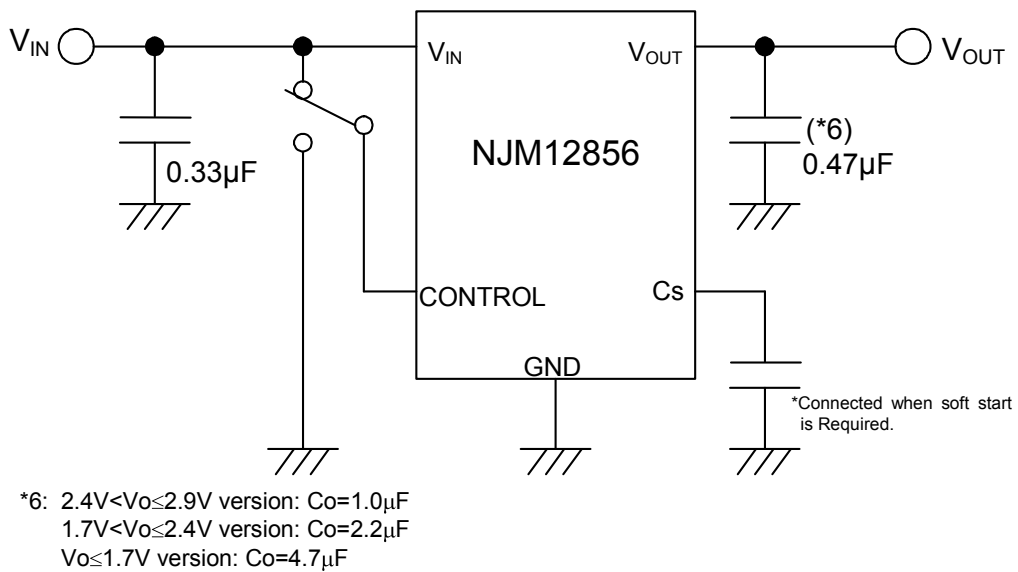

State of CONTROL Pin:

“H” → output is enabled.

“L” or “open” → output is disabled

# NJM12856

## \*Reverse Current Protection

The NJM12856 has built-in Reverse Current Protection circuit.

This circuit prevents the large reverse current when output voltage is higher than input voltage.

Therefore external schottky-barrier diode(SBD) is not required

## \*Soft Start capacitor Cs

The Soft Start function can control the rise time of Output Voltage and reduce the inrush current by connecting the Cs capacitor.

The Soft Start time is defined as 10% to 90% of the Output Voltage.

The Cs capacitor is not essential, but it used for noise bypass of bandgap reference either. Therefore Output Noise Voltage increases when the capacitor isn't connected.

If the Cs capacitor is not used, the Cs Pin should be OPEN.

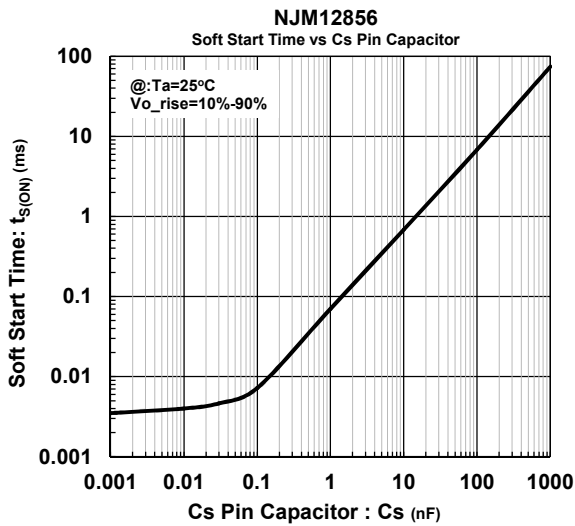

Soft-Start Time vs. Cs Pin Capacitor

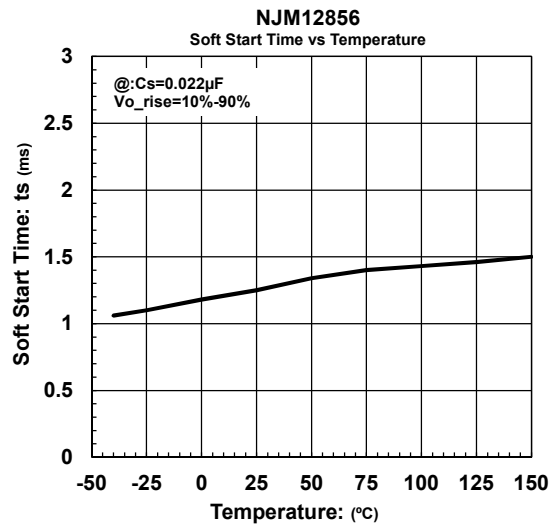

Soft-Start Time (0.022µF) vs. Temperature

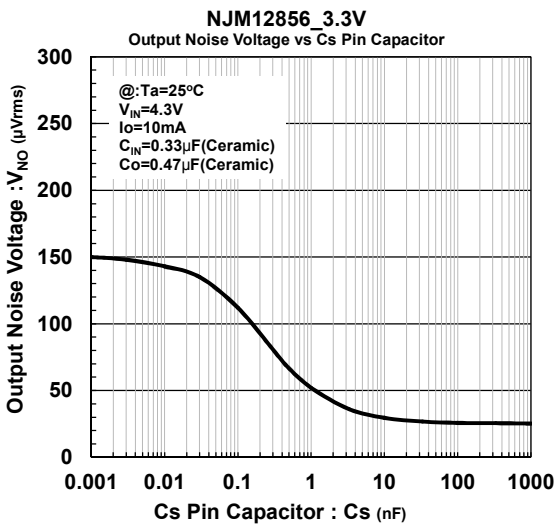

Output Noise Voltage vs. Cs Pin Capacitor

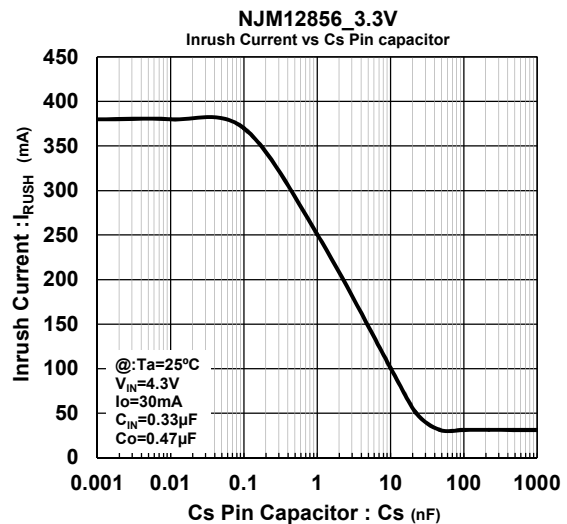

Inrush Current vs. Cs Pin Capacitor

## \*Discharge Function

The NJM12856 has a built-in discharge circuit to discharge the charged output capacitors.

Discharge circuit operates when the CONTROL Pin is set in LOW level. The circuit discharges the charged output capacitors rapidly.

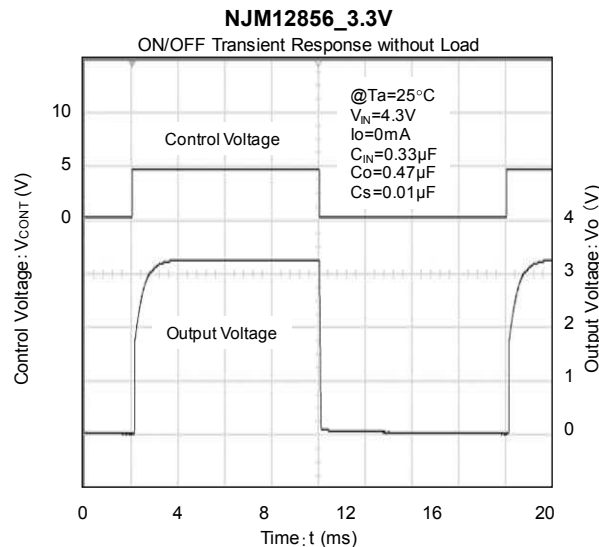

Output Voltage sweep down characteristics by Discharge function

## \*Input Capacitor $C_{IN}$

The input capacitor  $C_{IN}$  is required to prevent oscillation and reduce power supply ripple for applications when high power supply impedance or a long power supply line.

Therefore, use the recommended  $C_{IN}$  value (refer to conditions of ELECTRIC CHARACTERISTIC) or larger and should connect between GND and  $V_{IN}$  as shortest path as possible to avoid the problem.

## \*Output Capacitor $C_O$

The output capacitor  $C_O$  will be required for a phase compensation of the internal error amplifier.

The capacitance and the equivalent series resistance (ESR) influence to stable operation of the regulator.

Use of a smaller  $C_O$  may cause excess an output noise or an oscillation of the regulator due to lack of the phase compensation.

On the other hand, use of a larger  $C_O$  reduces an output noise and a ripple output, and also improves an output transient response when a load rapidly changes.

Therefore, use the recommended  $C_O$  value (refer to conditions of ELECTRIC CHARACTERISTIC) or larger and should connect between GND and  $V_{OUT}$  as shortest path as possible for stable operation

The recommended capacitance depends on the output voltage rank. Especially, a low voltage regulator requires larger  $C_O$  value.

In addition, you should consider varied characteristics of capacitor (a frequency characteristic, a temperature characteristic, a DC bias characteristic and so on) and unevenness peculiar to a capacitor supplier enough.

When selecting  $C_O$ , recommend that have withstand voltage margin against an output voltage and superior temperature characteristics though this product is designed stability works with wide range ESR of capacitor including low ESR products.

# NJM12856

## ■ TYPICAL CHARACTERISTICS

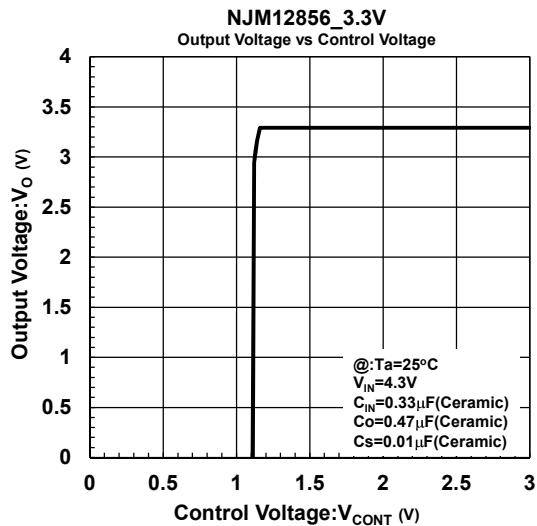
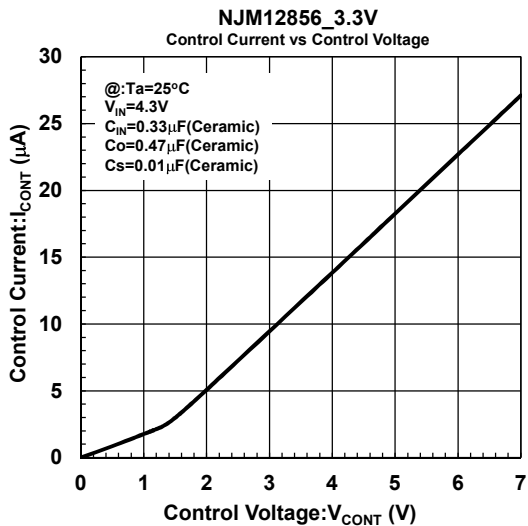
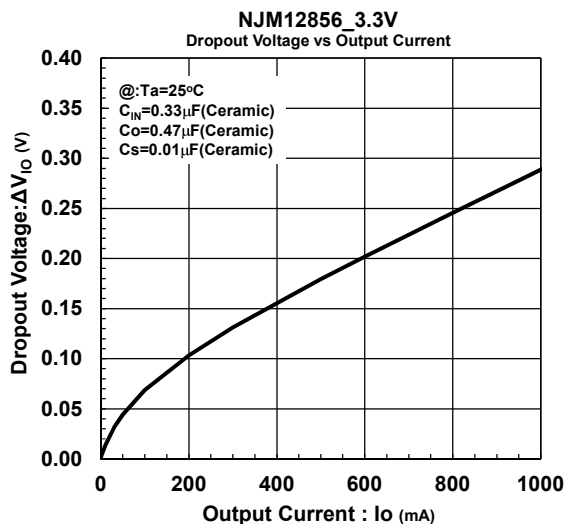
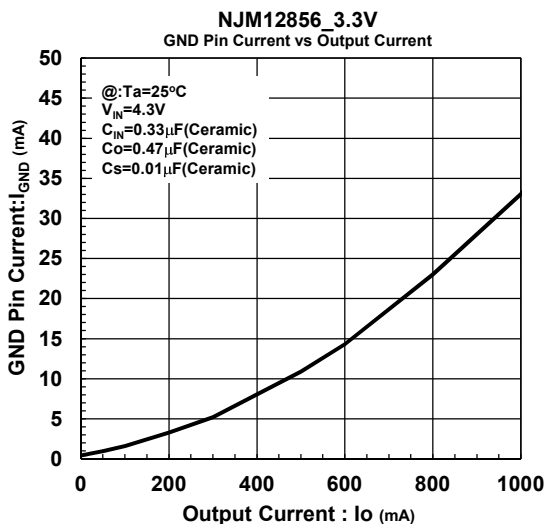
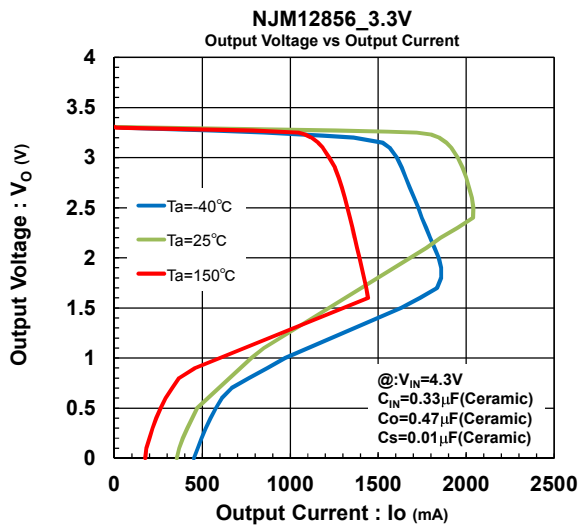
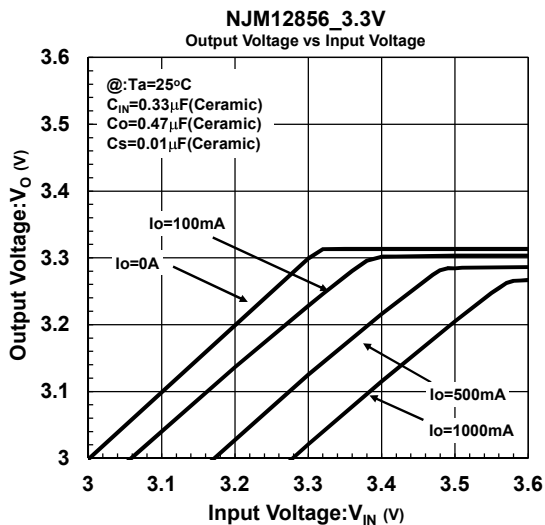



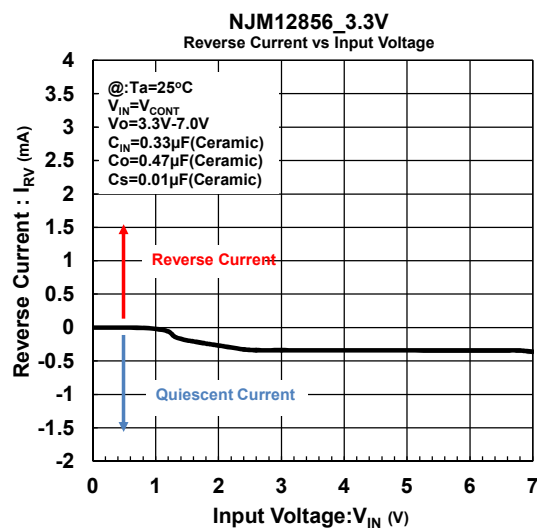
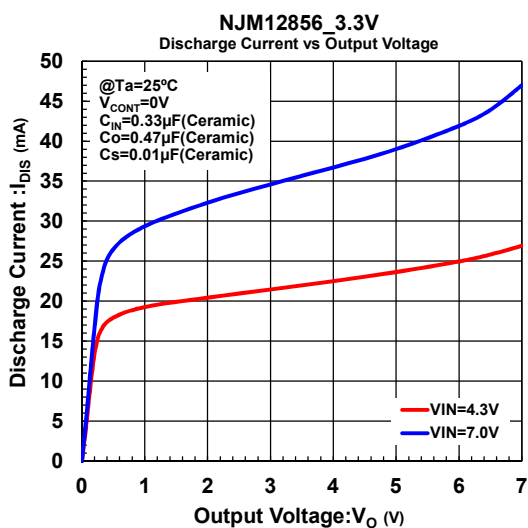
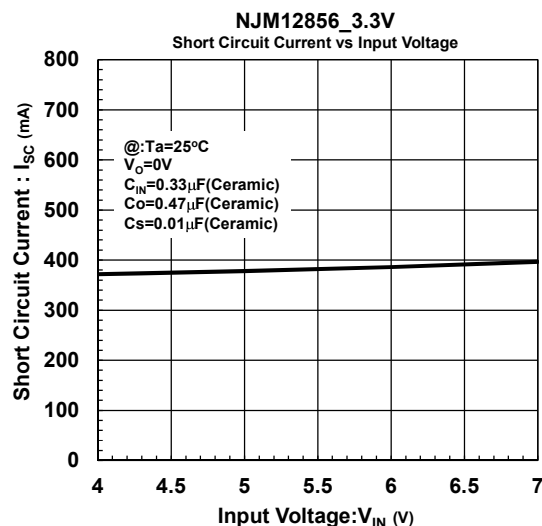
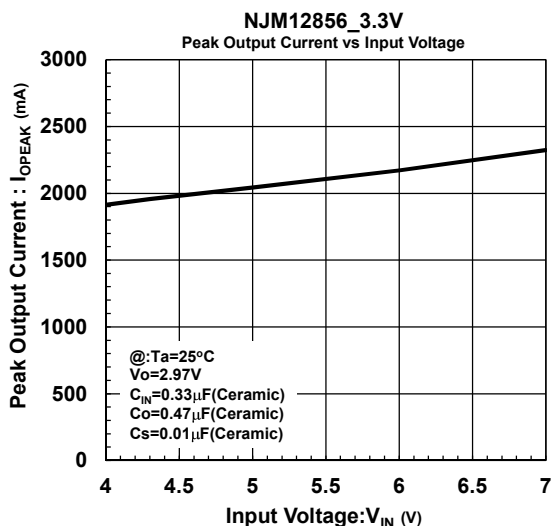
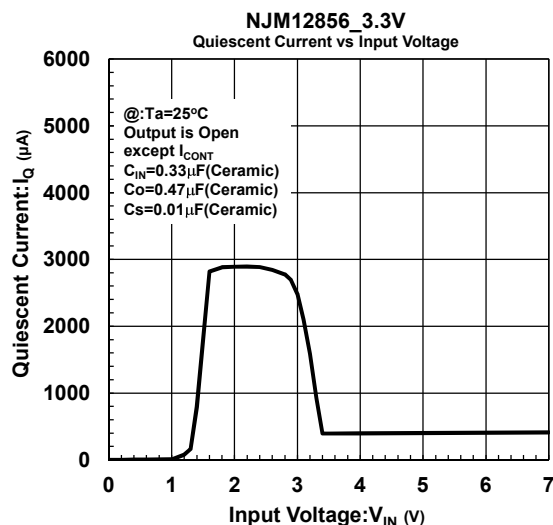
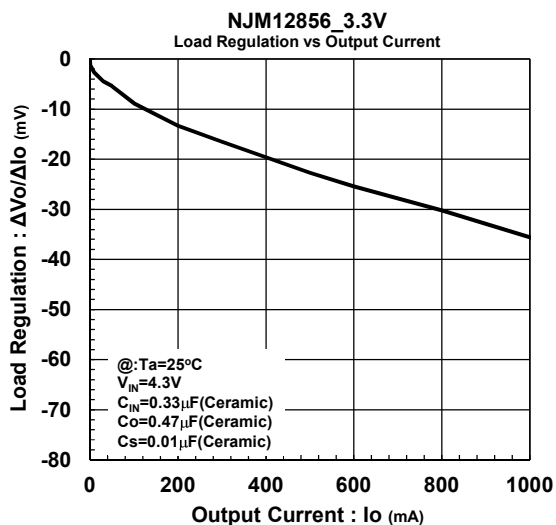

# NJM12856

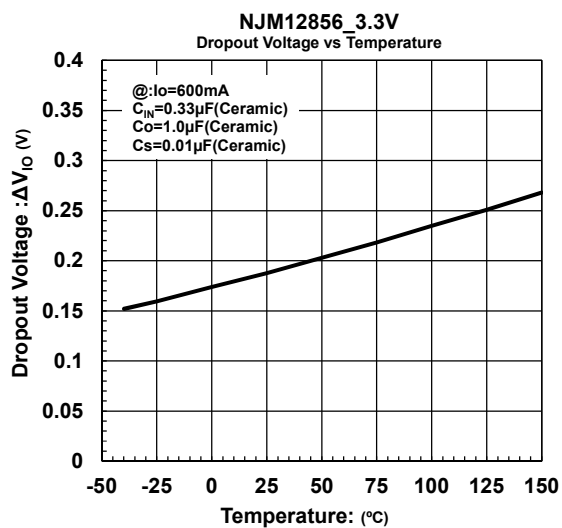
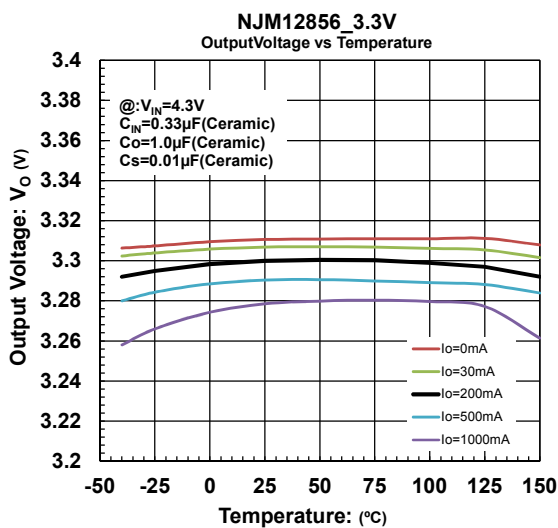
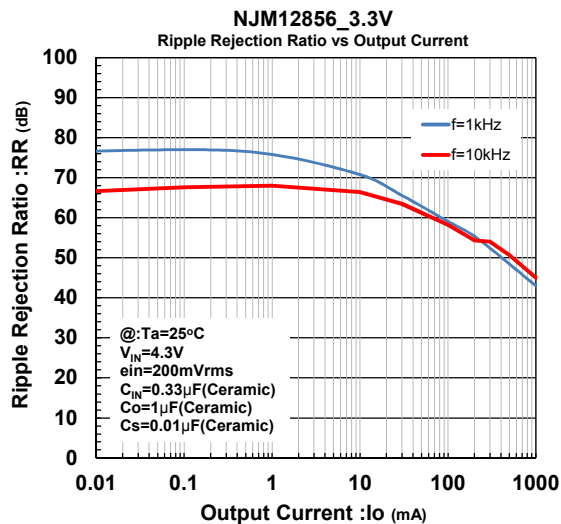
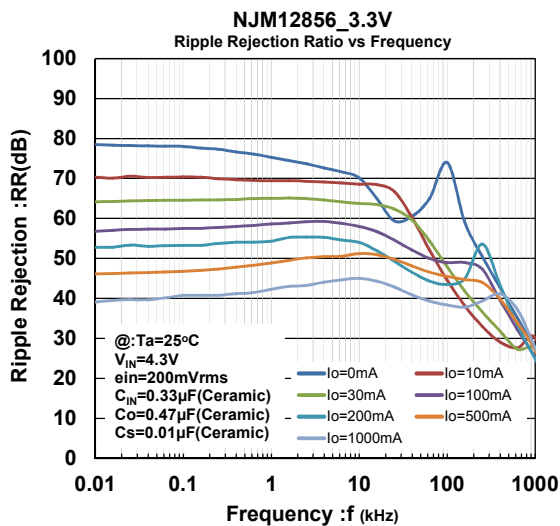
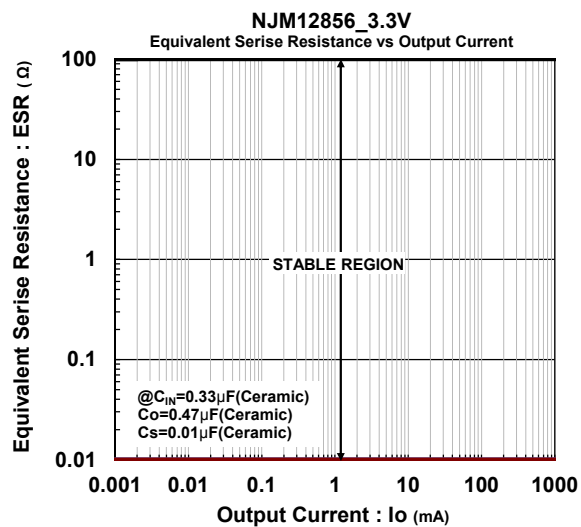
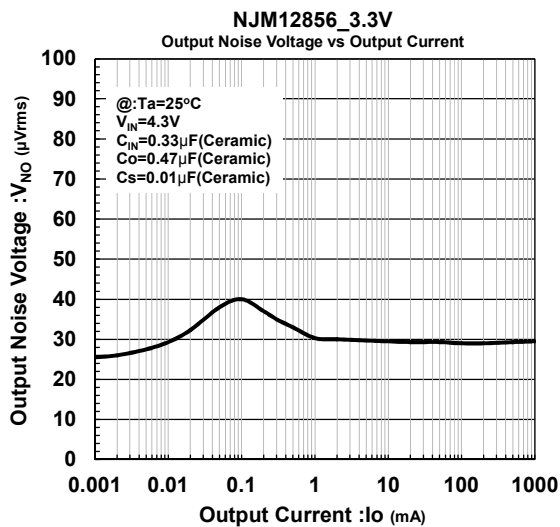

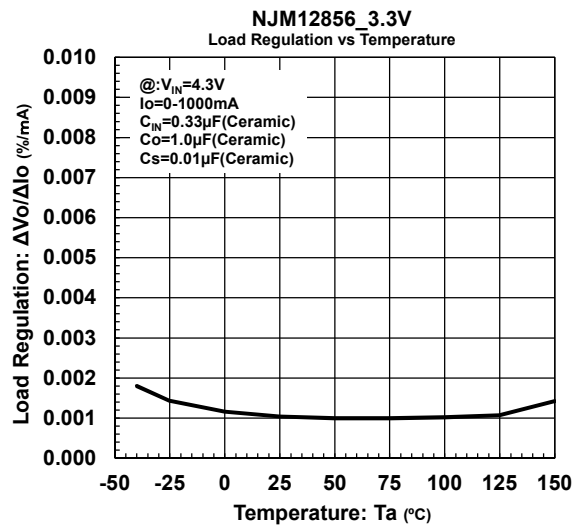
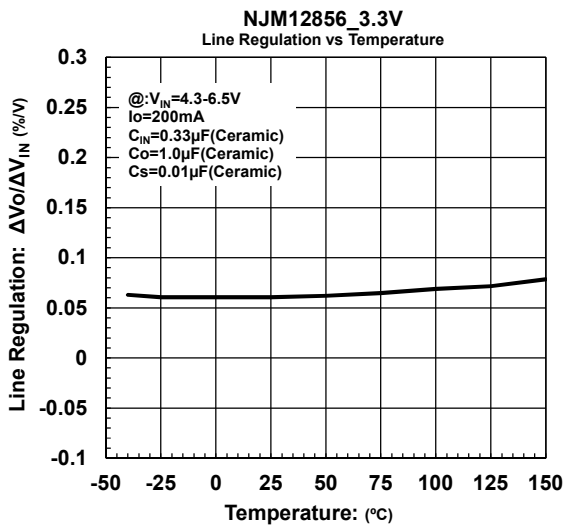
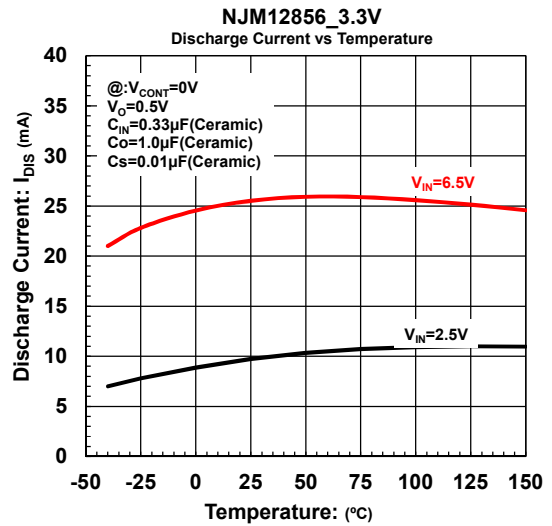
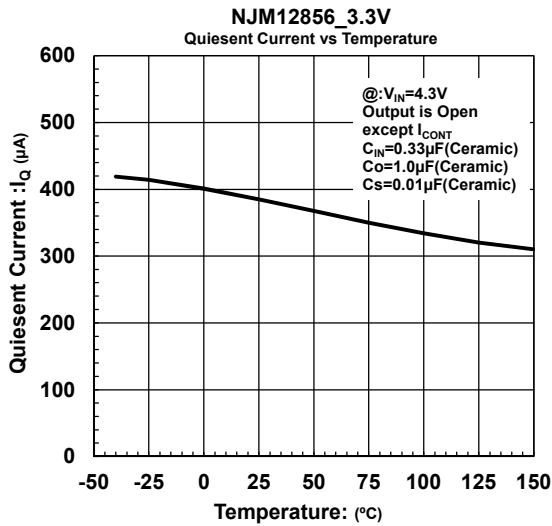
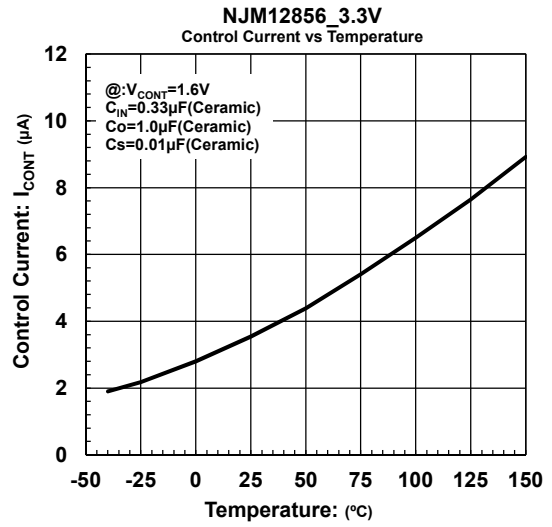
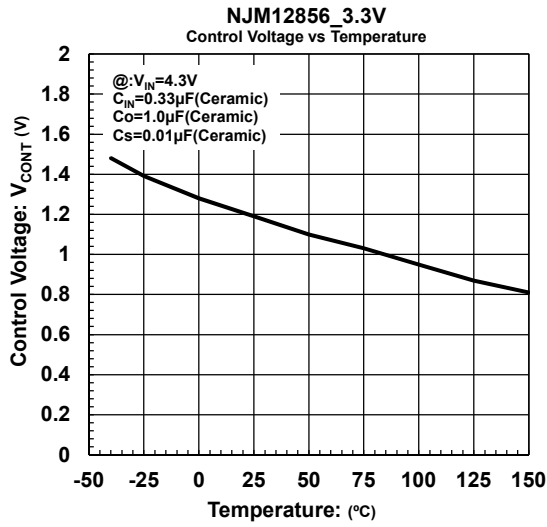

# NJM12856

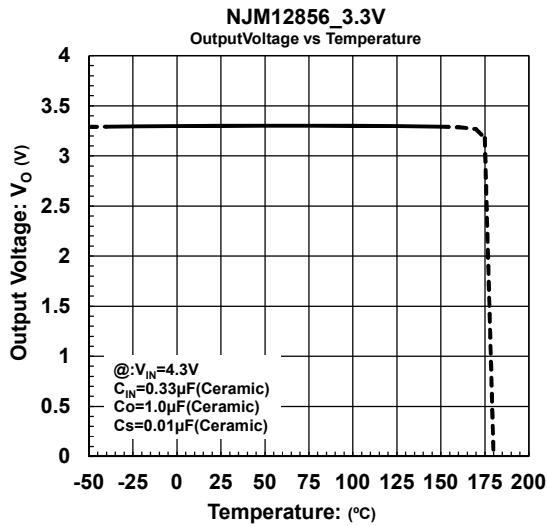
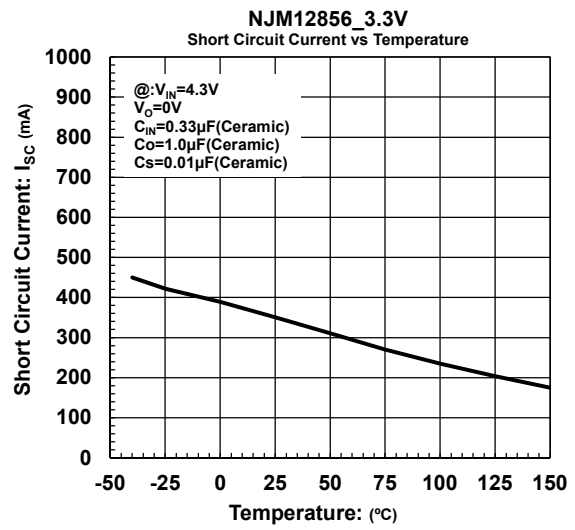
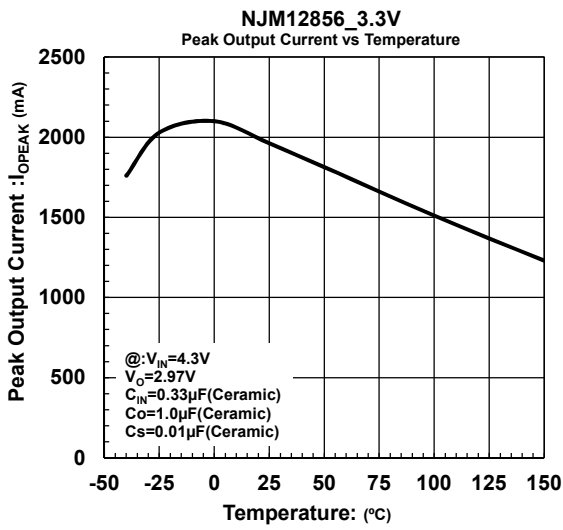

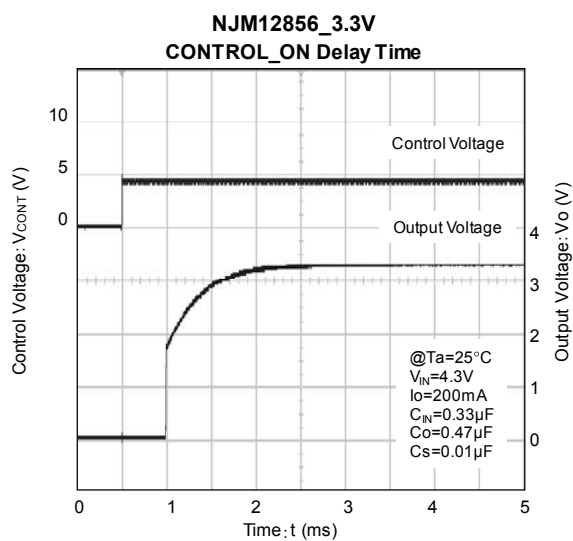
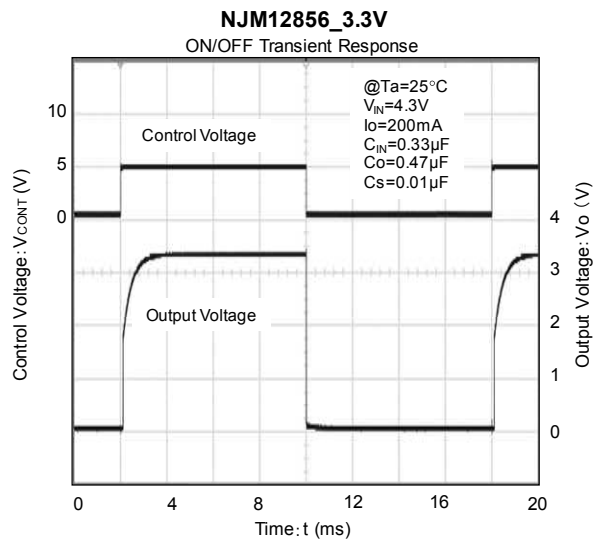
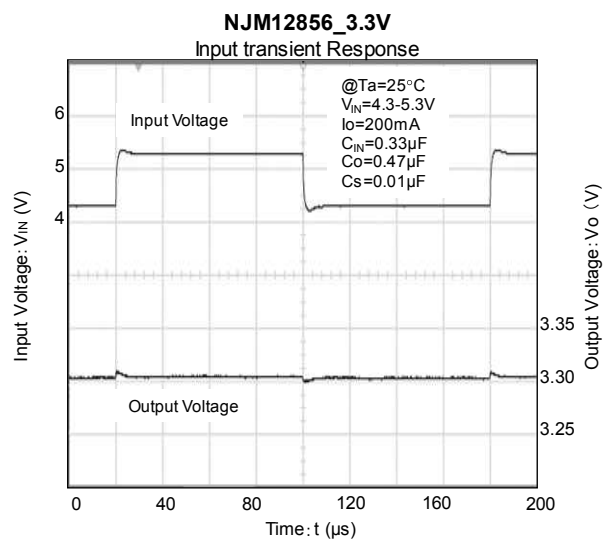
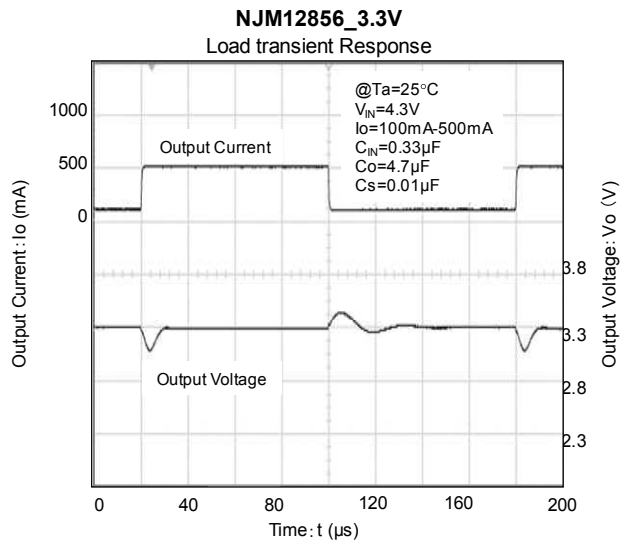
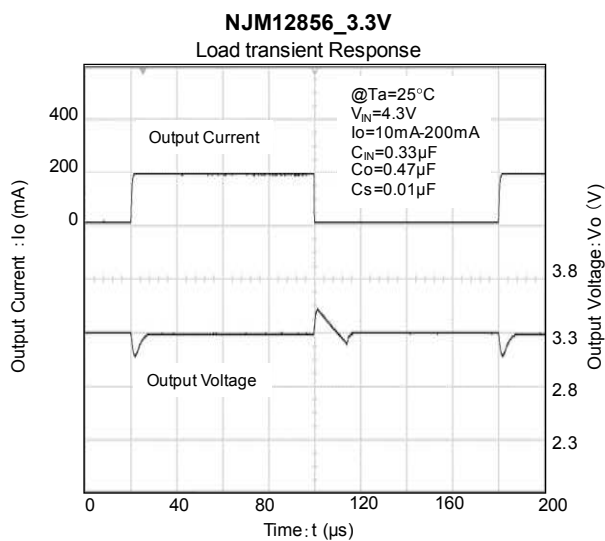

[CAUTION]

The specifications on this databook are only given for information, without any guarantee as regards either mistakes or omissions. The application circuits in this databook are described only to show representative usages of the product and not intended for the guarantee or permission of any right including the industrial rights.