

- **FEATURES:** ■ HIGH VOLTAGE CAPABILITY ■ HIGH SPEED SWITCHING ■ WIDE SOA
- **APPLICATION:** ■ FLUORESCENT LAMP ■ ADAPTER CHARGER

● **Absolute Maximum Ratings (TC=25°C)** **TO-92**

PARAMETER	SYMBOL	VALUE	UNIT
Collector-Base Voltage	V_{CBO}	700	V
Collector-Emitter Voltage	V_{CEO}	480	V
Emitter- Base Voltage	V_{EBO}	9	V
Collector Current	I_C	0.5	A
Total Power Dissipation	P_C	7	W
Junction Temperature	T_j	150	°C
Storage Temperature	T_{stg}	-65-150	°C

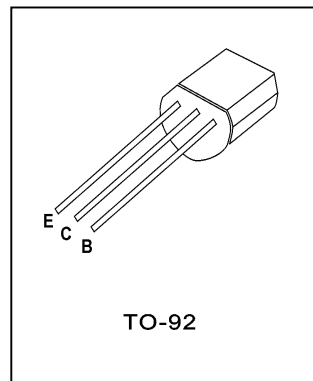

● **Electronic Characteristics (Tc=25°C)**

CHARACTERISTICS	SYMBOL	TEST CONDITION	MIN	MAX	UNIT
Collector-Base Cutoff Current	I_{CBO}	$V_{CB}=700V$		100	μA
Collector-Emitter Cutoff Current	I_{CEO}	$V_{CE}=480V, I_B=0$		250	μA
Collector-Emitter Voltage	V_{CEO}	$I_C=10mA, I_B=0$	480		V
Emitter- Base Voltage	V_{EBO}	$I_E=1mA, I_C=0$	9		V
Collector-Emitter Saturation Voltage	V_{ces}	$I_C=0.05A, I_B=0.01A$		0.5	V
		$I_C=0.1A, I_B=0.02A$		1.0	
		$I_C=0.3A, I_B=0.1A$		3.0	
Base-Emitter Saturation Voltage	V_{BES}	$I_C=0.1A, I_B=0.02A$		1.5	V
DC Current Gain	h_{FE}	$V_{CE}=5V, I_C=1mA$	8		
		$V_{CE}=5V, I_C=20mA$	10	40	
		$V_{CE}=5V, I_C=200mA$	8		
Storage Time	t_s	$V_{CC}=250V,$ $I_C=5I_B$ $I_{B1} = -I_{B2}=0.04A$		2.0	μS
Falling Time	t_f			0.8	

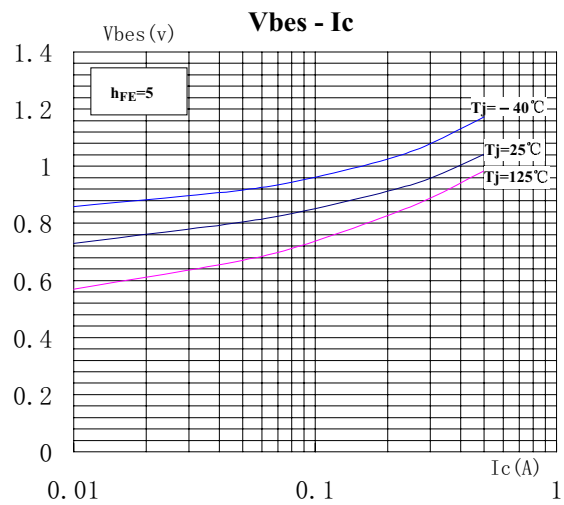
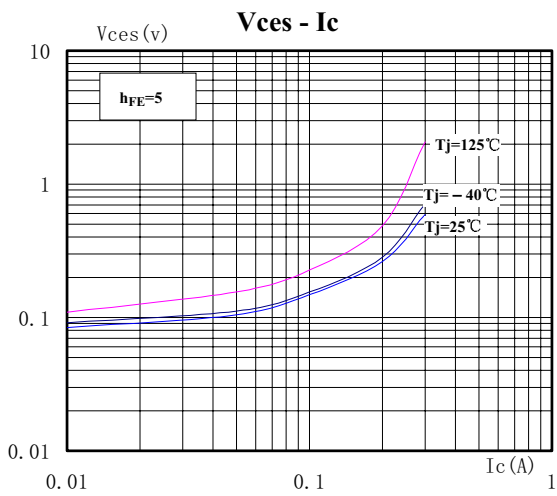
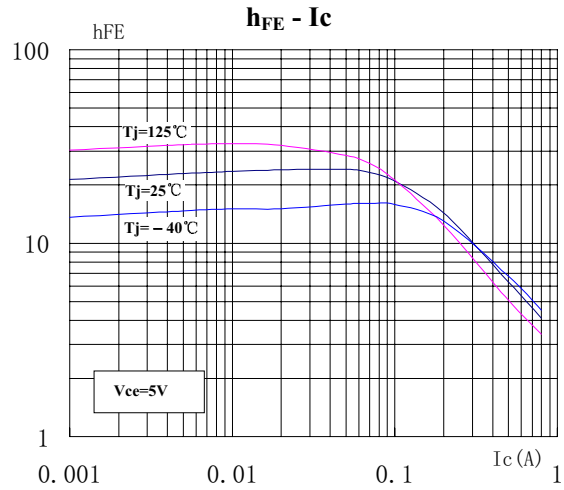
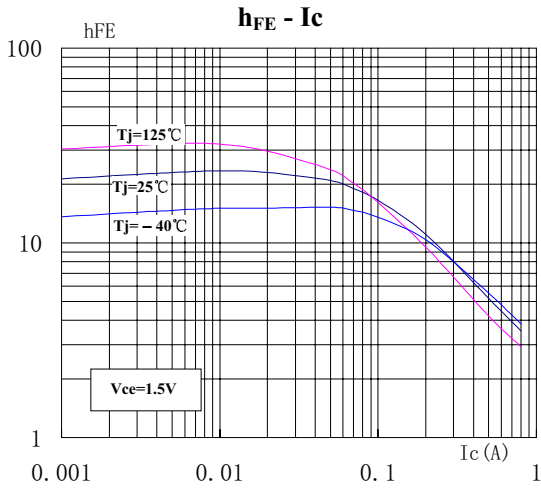
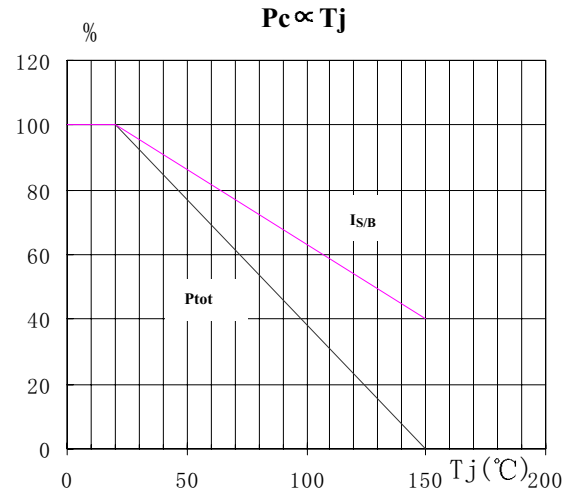
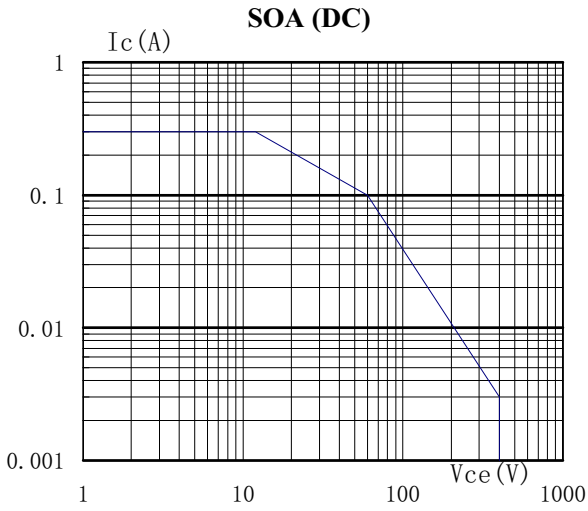

TO-92 MECHANICAL DATA

UNIT: mm

SYMBOL	min	nom	max
A	4.3		5.3
b	0.3		
c	0.3		
ϕD	4.3		5.2
D			
d	1.0		1.7
E	3.2		4.2
e		2.54	
e1		1.27	
L	12.7		
L1			2.0

