

VOLTAGE DETECTOR

■ GENERAL DESCRIPTION

The NJM2078 is a dual comparator including precise reference circuit. Output stages are open collector and can be used on wired OR. The NJM 2078 has hysteresis terminals.

As it is less operating current, the NJM2078 is suitable for voltage detection of decreased power supply in memory stack and abnormal voltage.

■ PACKAGE OUTLINE

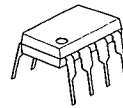

NJM2078D



NJM2078M

■ FEATURES

- Low Operating Current (250 μ A typ.)
- Stable Internal Reference Voltage (1.20V typ.)
- Hysteresis Function with Resistors
- Package Outline DIP8, DMP8
- Bipolar Technology

■ PIN CONFIGURATION

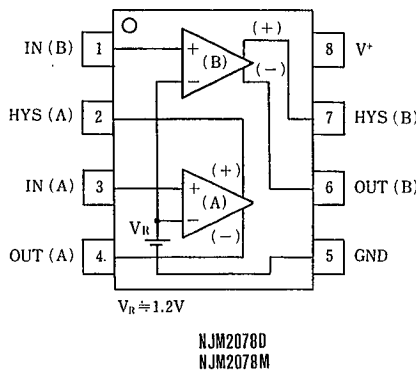

■ EQUIVALENT CIRCUIT

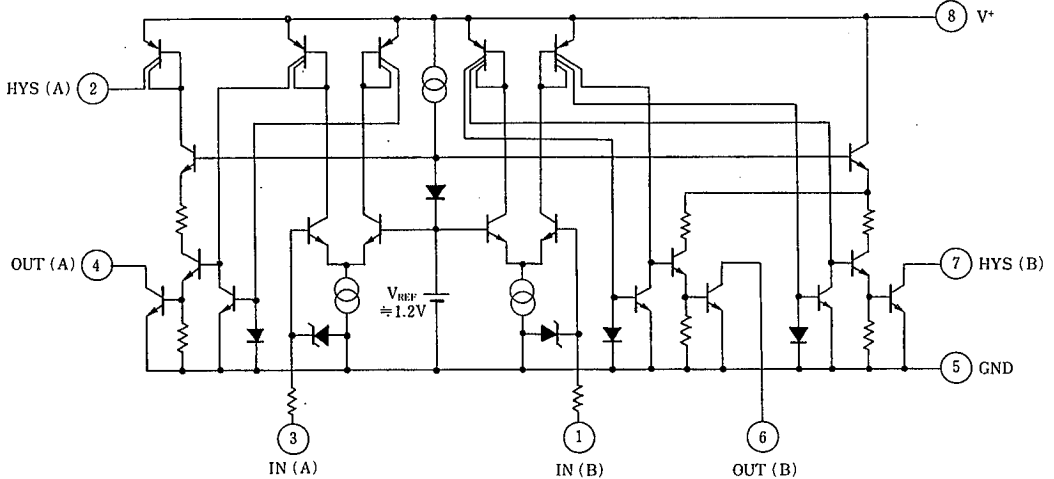

6

■ ABSOLUTE MAXIMUM RATINGS

(Ta=25°C)

PARAMETER	SYMBOL	RATINGS	UNIT
Supply Voltage	V ⁺	21	V
Output Voltage	V _O	21	V
Output Current	I _O	50	mA
Input Voltage	V _{IN}	-0.3~+6.5	V _{dc}
Power Dissipation	P _D	(DIP8) 500	mW
		(DMP8) 300	mW
Operating Temperature Range	T _{opr}	-40~+85	°C
Storage Temperature Range	T _{stg}	-40~+125	°C

6

■ ELECTRICAL CHARACTERISTICS

(V⁺=5V, T_a=25°C)

PARAMETER	SYMBOL	CONDITION	MIN.	TYP.	MAX.	UNIT
Operating Current	I _{CC1}	V ⁺ =20V, V _{IL} =1.0V	—	250	400	μA
	I _{CC11}	V ⁺ =20V, V _{1H} =1.5V	—	400	600	μA
Threshold Voltage	V _{TH}	I _O =2mA, V _O =1V	1.15	1.20	1.25	V
Threshold Voltage Deviation vs. Operating Voltage	ΔV _{TH1}	2.5V ≤ V ⁺ ≤ 5.5V	—	3	12	mV
	ΔV _{TH2}	4.5V ≤ V ⁺ ≤ 20V	—	10	40	mV
Offset Voltage Between Normal Output and Hysteresis Output		I _O (A)=4.5mA, V _O (A)=2V, I _H (A)=20μA, V _H (A)=3V	—	2.0	—	mV
		I _O (B)=3mA, V _O (B)=2V, I _H (B)=3mA, V _H (B)=2V	—	2.0	—	mV
Threshold Voltage Temperature Coefficient		-20°C ≤ T _a ≤ 70°C	—	±0.05	—	mV/°C
Threshold Voltage Difference Between Channels			-10	—	10	mV
Input Current	I _{IL}	I _{IL} =1.0V	—	5	—	nA
	I _{1H}	I _{1H} =1.5V	—	100	500	nA
Output Leak Current	I _{OH}	V _O =20V, V _{IL} =1.0V	—	—	1	μA
Hysteresis Output Leak Current	I _{1H} (A)	V ⁺ =20V, V _H (A)=0V, V _{IL} =1.0V	—	—	0.1	μA
	I _{1H} (B)	V _H (B)=20V, V _{1H} =1.5V	—	—	1	μA
Output Sink Current	I _{OL} (A)	V _O =1.0V, V _{1H} =1.5V	6	12	—	mA
	I _{OL} (B)	V _O =1.0V, V _{1H} =1.5V	4	10	—	mA
Hysteresis Current	I _{1H} (A)	V _H =0V, V _{1H} =1.5V	40	80	—	μA
	I _{1H} (B)	V _H =1.0V, V _{IL} =1.0V	4	10	—	mA
Output Saturation Voltage	V _{OL} (A)	I _O =4.5mA, V _{1H} =1.5V	—	120	400	mV
	V _{OL} (B)	I _O =3.0mA, V _{1H} =1.5V	—	120	400	mV
Hysteresis Output Saturation Voltage	V _{1H} (A)	I _H =20μA, V _{1H} =1.5V	—	50	200	mV
	V _{1H} (B)	I _H =3.0mA, V _{IL} =1.0V	—	120	400	mV
Delay Time	t _{PHL}	R _L =5kΩ	—	2	—	μs
	t _{PLH}	R _L =5kΩ	—	3	—	μs

6

■ OPERATION PRINCIPLE

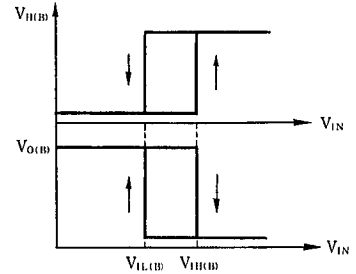
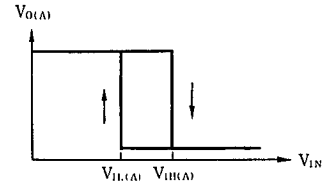
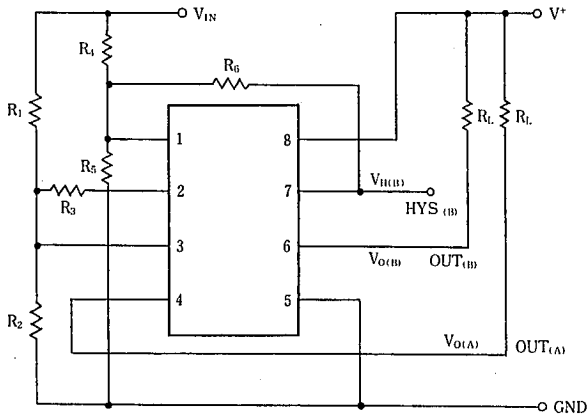

Equation 1

$$V_{IH(A)} = \left(1 + \frac{R_1}{R_2}\right) V_R$$

$$V_{IH(B)} = \left(1 + \frac{R_4}{R_5 \parallel R_6}\right) V_R$$

$$V_{IL(A)} = \left(1 + \frac{R_1}{R_2 \parallel R_3}\right) V_R - \frac{R_1}{R_3} V^+$$

$$V_{IL(B)} = \left(1 + \frac{R_4}{R_5}\right) V_R$$

(note) $V_R \approx V_{TH} (\approx 1.20V)$

$$R_2 \parallel R_3 = \frac{R_2 R_3}{R_2 + R_3}$$

$$R_5 \parallel R_6 = \frac{R_5 R_6}{R_5 + R_6}$$

■ TYPICAL APPLICATION

1. Hysterisis

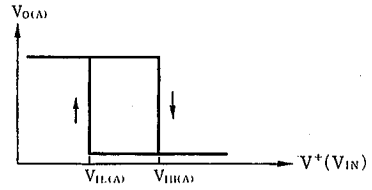
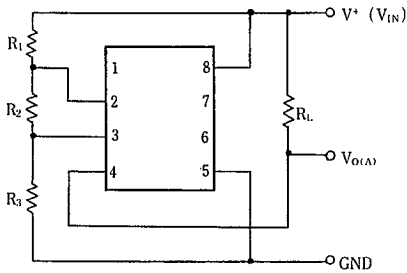

$$V_{IH(A)} \doteq \left(1 + \frac{R_1 + R_2}{R_3} \right) V_R$$

$$V_{IL(A)} \doteq \left(1 + \frac{R_2}{R_3} \right) V_R$$

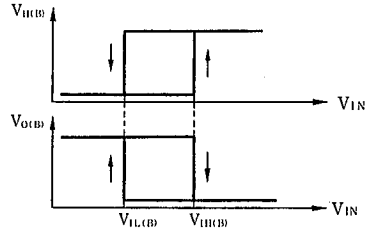
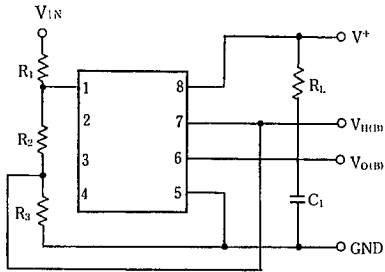

$$V_{IH(B)} \doteq \left(1 + \frac{R_1}{R_2} \right) V_R$$

$$V_{IL(B)} \doteq \left(1 + \frac{R_1}{R_2 + R_3} \right) V_R$$

Each equation is calculated without considering the saturation voltage. It is necessary to compensate by the saturation voltage fit to lead conditions, precisely.

2. Detection of Abnormal Supply Voltage

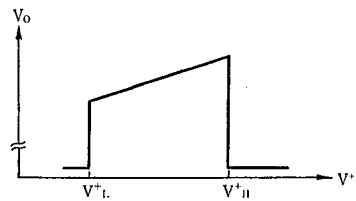
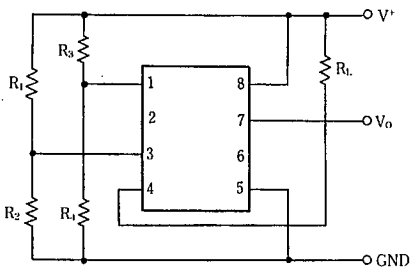

$$V^+_{H} = \left(1 + \frac{R_1}{R_2} \right) V_R$$

$$V^+_{L} = \left(1 + \frac{R_3}{R_4} \right) V_R$$

Note: $V^+ \geq 2.5V$

Hysteresis; Positive feedback from pin 2 or pin 7 (ref. 1).

6

3. Detection of Abnormal Operating Voltage

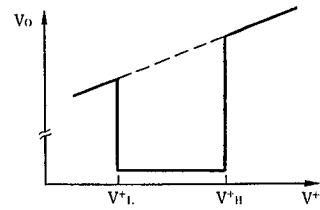
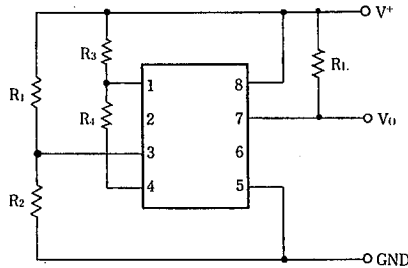

$$V^+_{H} = (1 + \frac{R_3}{R_4})V_R$$

$$V^+_{L} = (1 + \frac{R_1}{R_2})V_R$$

Note: $V^+_{L} \geq 2.5V$

4. Programmable Zener

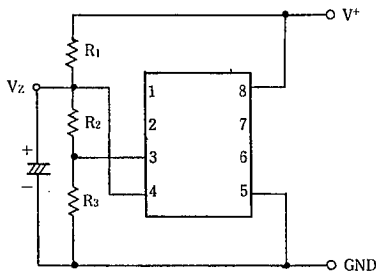

$$V_Z \approx (1 + \frac{R_2}{R_3})V_R$$

$$\frac{V_Z}{R_2 + R_3} \leq \frac{V^+ - V_Z}{R_1} \leq 6 \text{ mA}$$

Can use channel B independently.

5. Reset Circuit for Decreased Operating Voltage

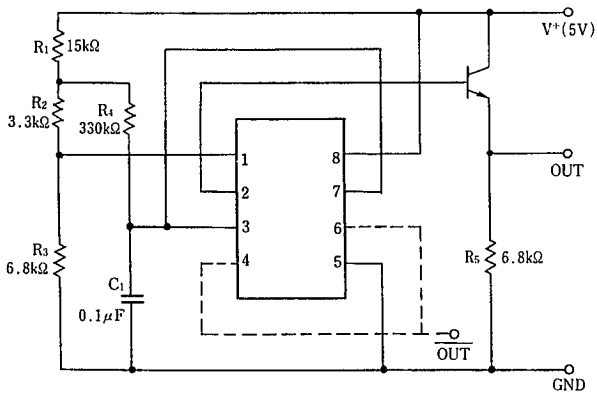

Compare Voltage and hysteresis width can be adjustable by $R_1 \sim R_4$. Roughly,

$$V^+_{(L)} = \frac{R_1 + R_2 + R_3}{R_3} V_{TH}$$

$$V^+_{(H)} = V^+_{(L)} \frac{R_1 (R_2 + R_3)}{R_3 R_4} V_{TH}$$

- Power-on reset time t_{RST} (roughly)

$$t_{RST} = -C_1 R_4 \ln \left\{ 1 - \frac{V_{TH}}{V^+} \left(1 + \frac{R_1}{R_2 + R_3} \right) \right\}$$
- Transistor; Recommended $h_{FE} = 50 \sim 200$
- Rapid Signal Off; Be care to remained charge of C_1 . It affects to t_{RST} .
- Reverse polarity output \overline{OUT} : Open collector.

■ TYPICAL CHARACTERISTICS

Operating Current

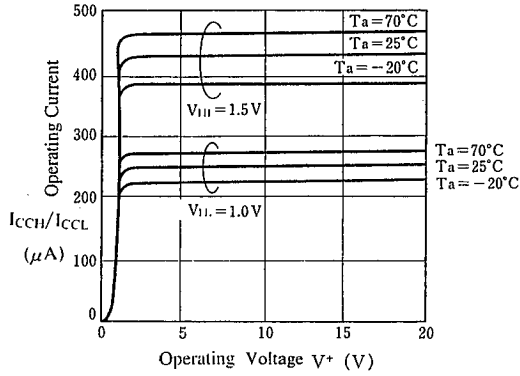

Hysteresis Current(A)

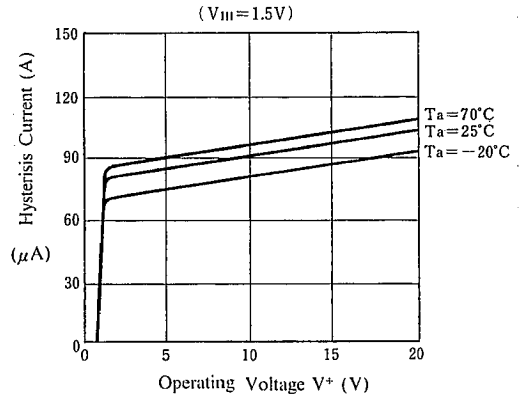

Output Saturation Voltage (A)

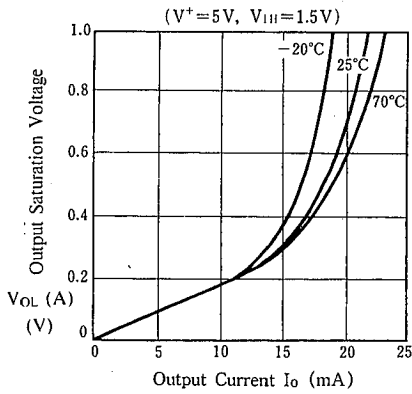

Output Saturation Voltage (B)

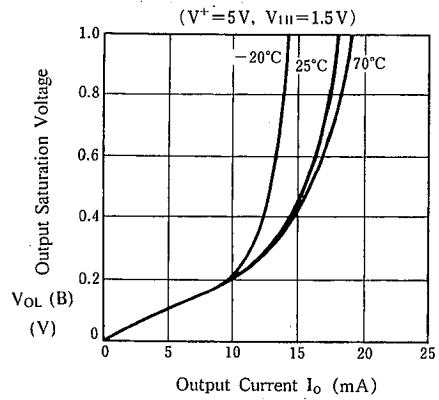

Threshold Voltage

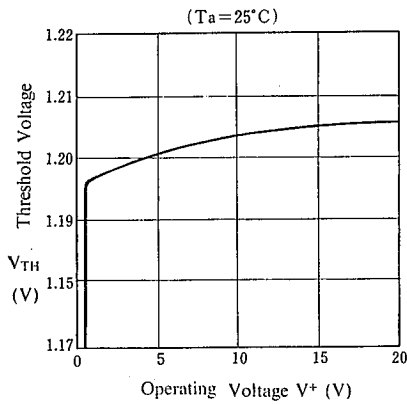

Threshold Voltage

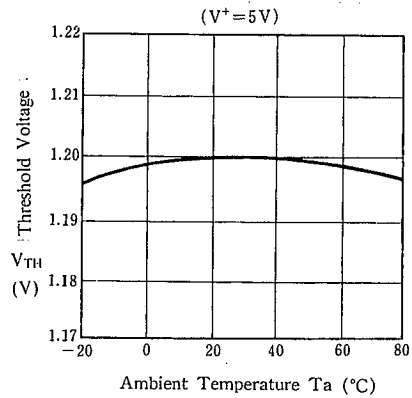

6

■ TYPICAL CHARACTERISTICS (Refer to Application 5 of Reset Circuit for Decreased Supply Voltage)

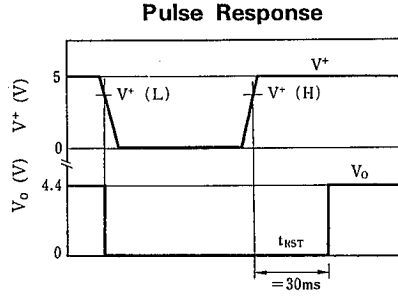
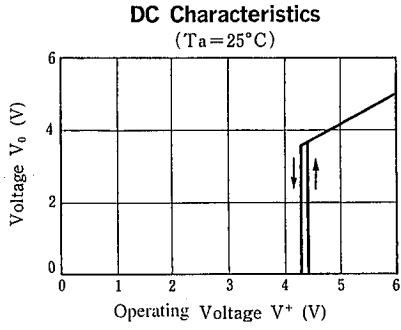

MEMO

[CAUTION]

The specifications on this databook are only given for information, without any guarantee as regards either mistakes or omissions. The application circuits in this databook are described only to show representative usages of the product and not intended for the guarantee or permission of any right including the industrial rights.