

DUAL OPERATIONAL AMPLIFIER

■ GENERAL DESCRIPTION

The NJM2140 is a low operating voltage ($\pm 1.0V$ min.) and low output saturation voltage operational amplifier of ultra miniature surface mount package.

Applications include Portable CD, Boom Box, Portable DAT and other digital audio systems which require single 5V operation and high output voltage swing.

■ PACKAGE OUTLINE



NJM2140R

■ FEATURES

- Low Operating Voltage ($\pm 1V \sim \pm 7V$)
- Slew Rate ($4V/\mu s$ typ.)
- Bandwidth ($12MHz$ typ.)
- Maximum Output Voltage Swings ($\pm 2.4V$ typ. at $V^+/V^- = \pm 2.5, R_L = 10k\Omega$)
- Bipolar Technology
- Package Outline VSP8

■ PIN CONFIGURATION

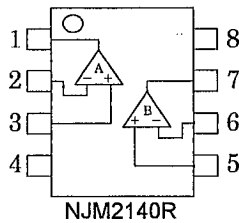

PIN FUNCTION

1. A OUTPUT
2. A- INPUT
3. A+ INPUT
4. V^-
5. B+ INPUT
6. B- INPUT
7. B OUTPUT
8. V^+

■ EQUIVALENT CIRCUIT (1/2 Shown)

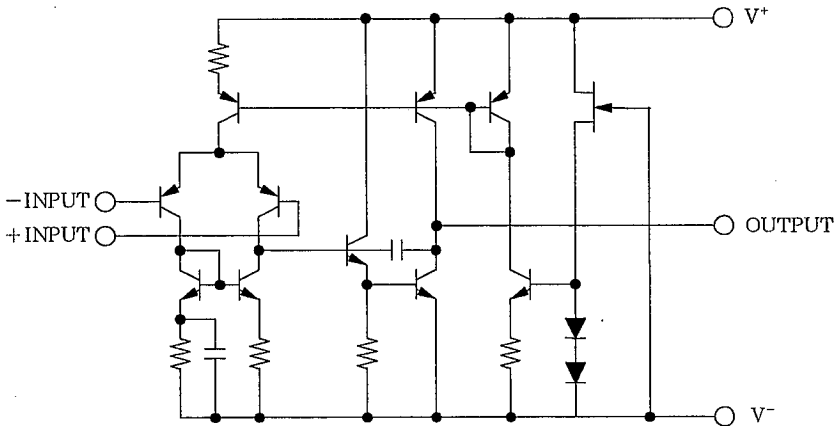

■ ABSOLUTE MAXIMUM RATINGS

(Ta=25°C)

PARAMETER	SYMBOL	RATINGS	UNIT
Supply Voltage	V ⁺ /V ⁻	±7.0	V
Differential Input Voltage	V _{ID}	±14	V
Power Dissipation	P _D	320	mW
Operating Temperature Range	T _{opr}	-40~85	°C
Storage Temperature Range	T _{stg}	-50~125	°C

■ ELECTRICAL CHARACTERISTICS

(V⁺/V⁻=2.5V, Ta=25°C)

PARAMETER	SYMBOL	TEST CONDITION	MIN.	TYP.	MAX.	UNIT
Input Offset Voltage	V _{IO}	R _s =0Ω	-	1	6	mV
Input Offset Current	I _{IO}		-	10	200	nA
Input Bias Current	I _B		-	100	300	nA
Large Signal Voltage Gain	A _v	R _L ≥10kΩ	60	80	-	dB
Maximum Output Voltage Swing1	V _{OM1}	R _L =2.5kΩ	±2.0	±2.2	-	V
Maximum Output Voltage Swing2	V _{OM2}	R _L ≥10kΩ	±2.3	±2.4	-	V
Input Common Mode Voltage Range	V _{ICM}		±1.5	-	-	V
Common Mode Rejection Ratio	CMR		60	74	-	dB
Supply Voltage Rejection Ratio	SVR		60	80	-	dB
Operating Current	I _{cc}		-	3.5	5	mA
Slew Rate	SR		-	4	-	V/μs
Gain Bandwidth Product	GB		-	12	-	MHz

■ TYPICAL CHARACTERISTICS

Maximum Peak-to-peak Output Voltage Swing vs. Frequency
($V^+ / V^- = \pm 2.5V, R_L = 2.5k\Omega, T_a = 25^\circ C$)

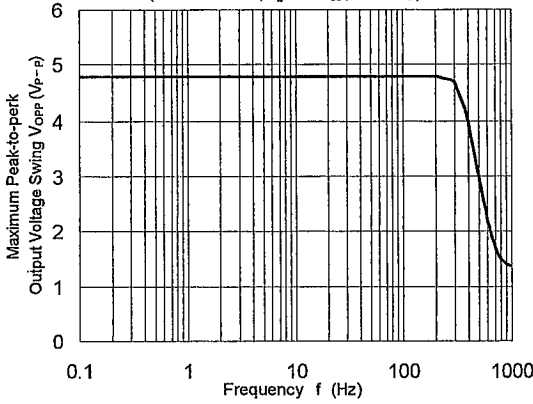

Equivalent Input Noise Voltage vs. Source Resistance
($V^+ / V^- = \pm 2.5V, T_a = 25^\circ C$)

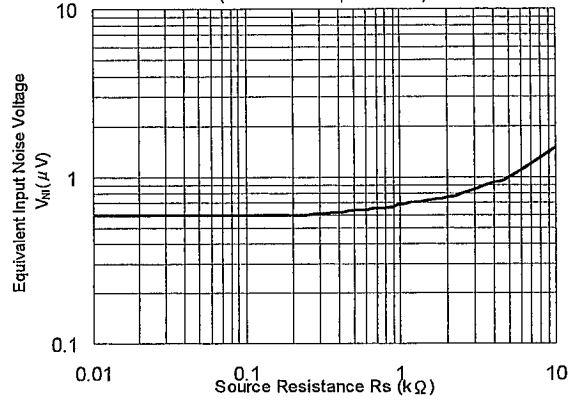

Operating Current vs. Temperature
($V^+ / V^- = \pm 2.5V$)

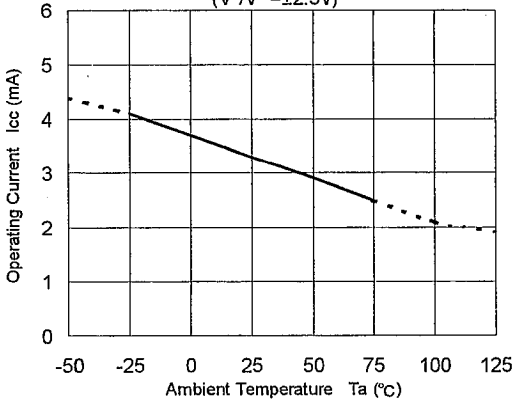

Input Offset Voltage vs. Temperature
($V^+ / V^- = \pm 2.5V, R_s = 10k\Omega$)

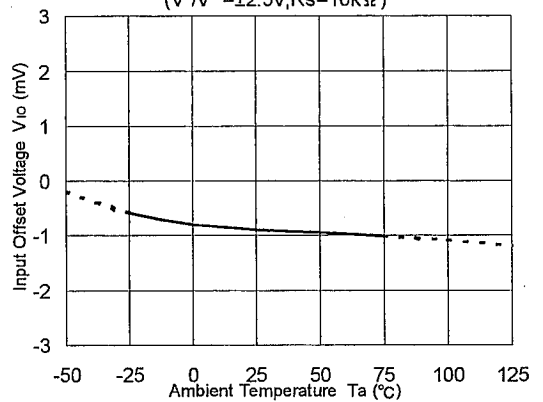

Input Bias Current vs. Temperature
($V^+ / V^- = \pm 2.5V, R_L = 2.5k\Omega$)

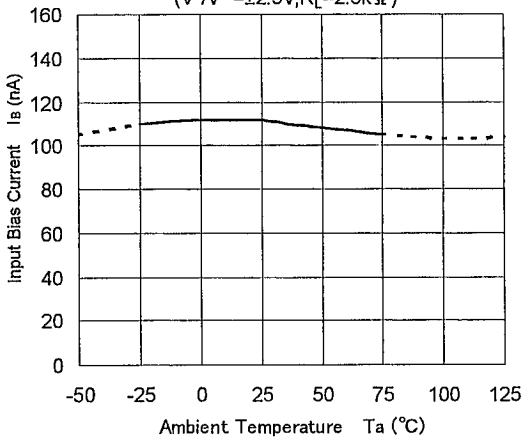

Output Voltage Swing vs. Temperature
($V^+ / V^- = 2.5V, R_L = 2.5k\Omega$)

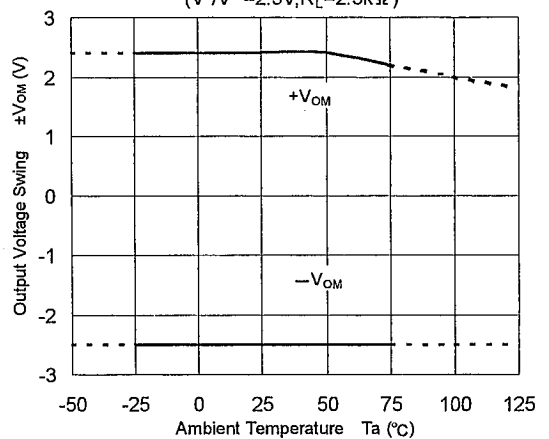

4

TYPICAL CHARACTERISTICS

Maximum Output Voltage Swing vs. Operating Voltage
($R_L=2.5k\Omega$, $T_a=25^\circ C$)

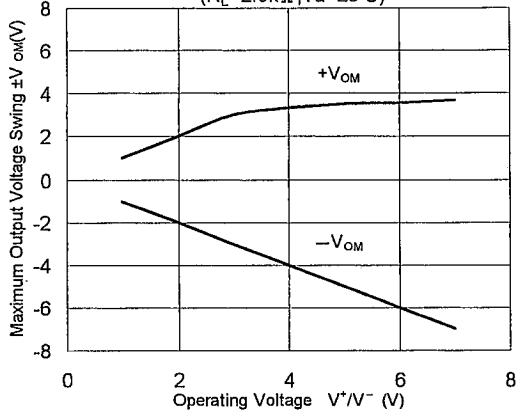

Operating Current vs. Operating Voltage
($T_a=25^\circ C$)

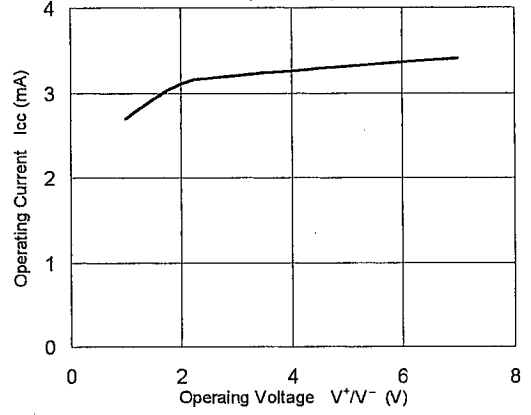

Maximum Output Voltage Swing vs. Load Resistance
($V^+ / V^- = \pm 2.5V$, $T_a=25^\circ C$)

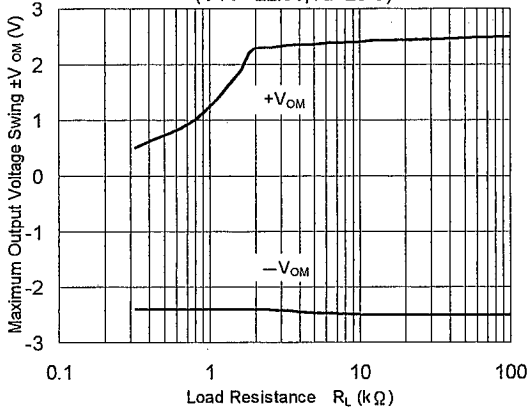

Input Bias Current vs. Operating Voltage
($T_a=25^\circ C$)

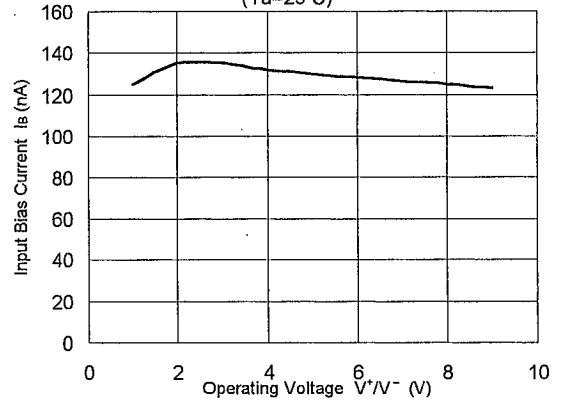

Input Offset Voltage vs. Operating Voltage
($T_a=25^\circ C$, $R_s=10k\Omega$)

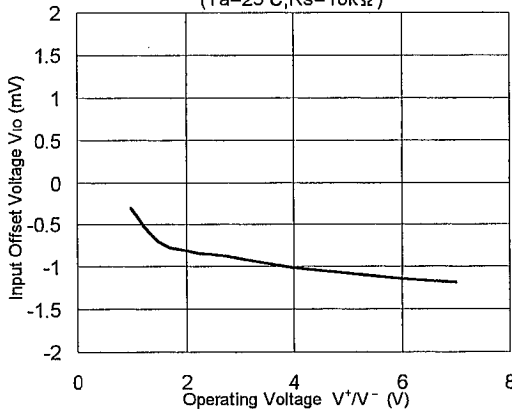

Total Harmonic Distortion vs. Output Voltage
($V^+ / V^- = \pm 2.5V$, $R_L=2.5k\Omega$, Gain=10dB)

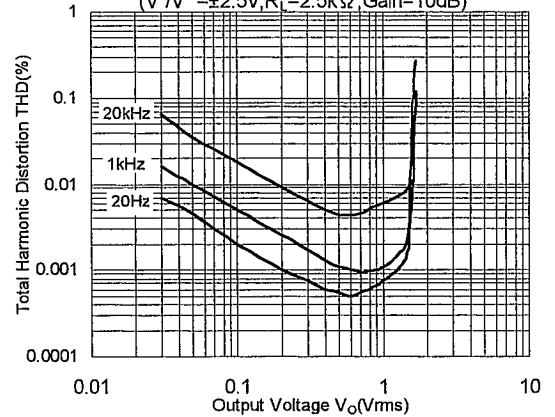

MEMO

[CAUTION]

The specifications on this databook are only given for information, without any guarantee as regards either mistakes or omissions. The application circuits in this databook are described only to show representative usages of the product and not intended for the guarantee or permission of any right including the industrial rights.