

## TWO OUTPUT HIGH VOLTAGE SWITCHING REGULATOR

### ■ GENERAL DESCRIPTION

New JRC's high voltage switching regulator, NJM2355, is a monolithic high voltage (50V max) operation integrated circuit consisting of two channel PWM controllers.

The NJM2355 contains an internal 5V reference, free running oscillator, low supply voltage detector, two comparators and three error amplifiers. The error amp 2 or amp 3 is for current limiting in channel B output circuit.

The NJM2355 is suited for DC to DC converter application; step up, step down, positive to negative.

### ■ PACKAGE OUTLINE

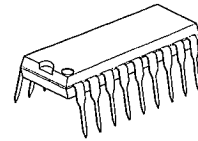

NJM2355D

### ■ FEATURES

- Operating Voltage (7.5V~50V)
- Complete PWM Power Control Circuit
- Uncommitted Outputs for 200-mA Sink or Source
- Output control Selects Single-Ended or Pull Operation
- Internal Circuitry Prohibits Double Pulse at Either Output
- Variable Dead-Time Provides Control Over Total Range
- Package Outline DIP18
- Bipolar Technology

### ■ BLOCK DIAGRAM & PIN CONFIGURATION

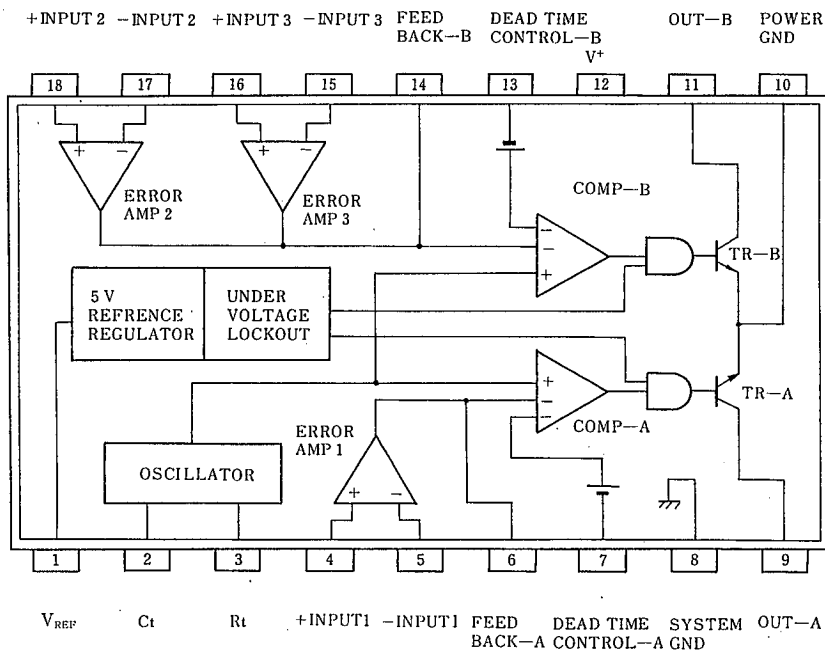

NJM2355D

## ■ ABSOLUTE MAXIMUM RATINGS

(Ta=25°C)

PARAMETER	SYMBOL	RATINGS	UNIT
Supply Voltage	V <sup>+</sup>	50	V
Output Current 1	I <sub>o1</sub>	200	mA
Output Current 2	I <sub>o2</sub>	200	mA
Power Dissipation	P <sub>D</sub>	700	mW
Operating Temperature Range	T <sub>opr</sub>	-20~+75	°C
Storage Temperature Range	T <sub>stg</sub>	-40~+125	°C

## ■ ELECTRICAL CHARACTERISTICS

(Ta=25°C, V<sup>+</sup>=15V)

PARAMETER	SYMBOL	TEST CONDITION	MIN.	TYP.	MAX.	UNIT
Operating Current (1)	I <sub>CC</sub> (1)	V <sup>+</sup> =15V	—	5.7	7.5	mA
Operating Current (2)	I <sub>CC</sub> (2)	V <sup>+</sup> =50V	—	5.9	8.0	mA

< Reference Section >

PARAMETER	SYMBOL	TEST CONDITION	MIN.	TYP.	MAX.	UNIT
Output Voltage	V <sub>REF</sub>	I <sub>REF</sub> =0mA	4.8	5.0	5.2	V
Line Regulation	REG <sub>in</sub>	V <sup>+</sup> =7.5V~50V, I <sub>REF</sub> =0mA	—	12	35	mV
Load Regulation	REG <sub>l</sub>	I <sub>REF</sub> =0mA~10mA	—	6	15	mV
Output Short Current			—	30	—	mA
Output disable Voltage	V <sub>nop</sub>	OUT=High Level	—	4.3	4.6	V
Output disable hysteresis Voltage	ΔV <sub>nop</sub>		—	0.3	—	V

< Oscillator Section >

PARAMETER	SYMBOL	TEST CONDITION	MIN.	TYP.	MAX.	UNIT
Frequency	F <sub>O</sub>	C <sub>i</sub> =0.01μF, R <sub>i</sub> =4.3kΩ	25	28	31	kHz

< Dead Interval Adjustment Section >

PARAMETER	SYMBOL	TEST CONDITION	MIN.	TYP.	MAX.	UNIT
Input Bias Current	I <sub>bdt</sub>	DT=0V	—	—	-10	μA
Maximum Duty (On-time)	ΔT <sub>on</sub> /T	C <sub>i</sub> =0.01μF, R <sub>i</sub> =4.3kΩ	90	—	—	%
Input Threshold Voltage	V <sub>th</sub>	Duty Cycle: 0%	2.0	2.5	3.0	V

< PWM Comparator Section >

PARAMETER	SYMBOL	TEST CONDITION	MIN.	TYP.	MAX.	UNIT
Input Threshold Voltage	V <sub>thc</sub>	Duty Cycle: 0%	—	—	4.5	V

## ■ ELECTRICAL CHARACTERISTICS

< Error Amplifier Section >

(V<sup>+</sup>=15V, T<sub>a</sub>=25°C)

PARAMETER	SYMBOL	TEST CONDITION	MIN.	TYP.	MAX.	UNIT
Input Offset Voltage	V <sub>IO</sub>	FB=2.5V	—	1	10	mV
Input Offset Current	I <sub>IO</sub>	FB=2.5V	—	5	250	nA
Input Bias Current	I <sub>B</sub>	FB=2.5V	—	0.05	1	μA
Common Mode Input Voltage Range	V <sub>ICM</sub>	V <sup>+</sup> =7.5V~50V	0	—	V <sub>CC</sub> -2	V
Voltage Gain	A <sub>V</sub>	FB=0.5V~3.5V	70	100	—	dB
Band Width	f <sub>i</sub>	AV=1	—	800	—	kHz
Common Mode Rejection Ratio	CMR	V <sub>CC</sub> =50V	65	80	—	dB
Output Sink Current	I <sub>SINK</sub>	V <sub>ID</sub> =5V, FB=0.7V	0.2	0.4	—	mA
Output Source Current	I <sub>SOURCE</sub>	V <sub>ID</sub> =5V, FB=3.5V	-1	-2.5	—	mA

< Output Section >

PARAMETER	SYMBOL	TEST CONDITION	MIN.	TYP.	MAX.	UNIT
Leak Current	I <sub>CER</sub>	V <sub>CE</sub> =50V	—	—	100	μA
Saturation Voltage	V <sub>SAT</sub>	I <sub>O</sub> =100mA	—	0.9	1.3	V

6

## ■ TERMINAL EXPLANATION

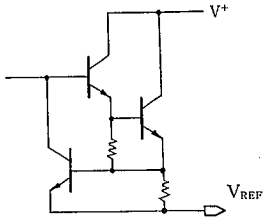
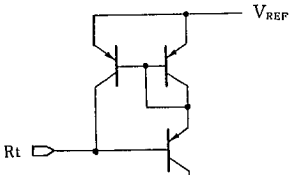
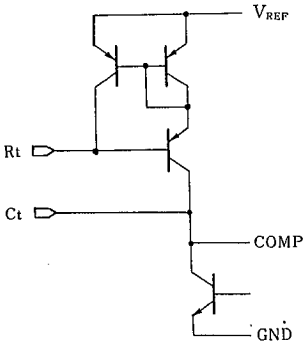
PIN NO.	PIN SYMBOL	FUNCTION	EQUIVALENT CIRCUIT
1.	$V_{REF}$	5V Reference Voltage Output	
2.	$C_t$	The oscillator frequency is decided by putting Capacitor, $C_t$ .	
3.	$R_t$	The oscillator frequency is decided by putting resistor, $R_t$ .	

6

■ TERMINAL EXPLANATION

PIN NO.	PIN SYMBOL	FUNCTION	EQUIVALENT CIRCUIT
4.	+INPUT1	+INPUT of Error Amp 1 (A Channel)	
5.	-INPUT1	-INPUT of Error Amp 1 (A Channel)	
16.	+INPUT3	+INPUT of Error Amp 3 (B Channel)	
15.	-INPUT3	-INPUT of Error Amp 3 (B Channel)	
18.	+INPUT2	+INPUT of Error Amp 2 (B Channel)	
17.	-INPUT2	-INPUT of Error Amp 2 (B Channel)	
6.	FEED BACK-A	OUTPUT of Error Amp 1 (A Channel)	
14.	FEED BACK-B	OUTPUT of Error Amp 2 and Error Amp 3 (B Channel)	

6

## ■ TERMINAL EXPLANATION

PIN NO.	PIN SYMBOL	FUNCTION	EQUIVALENT CIRCUIT
7. 13.	DEAD TIME CONTROL-A DEAD TIME CONTROL-B	The Dead Time Width is adjustable by terminal voltage adjust. (A Channel) (B-Channel)	
8.	SYSTEM GND	Ground	
9. 11.	OUT-A OUT-B	Internal Switching Transistor: Open Collector (A Channel) (B-Channel)	
10.	POWER GND	Ground Connect to PIN 8.	
12.	V+	Power Supply	

■ TYPICAL APPLICATION

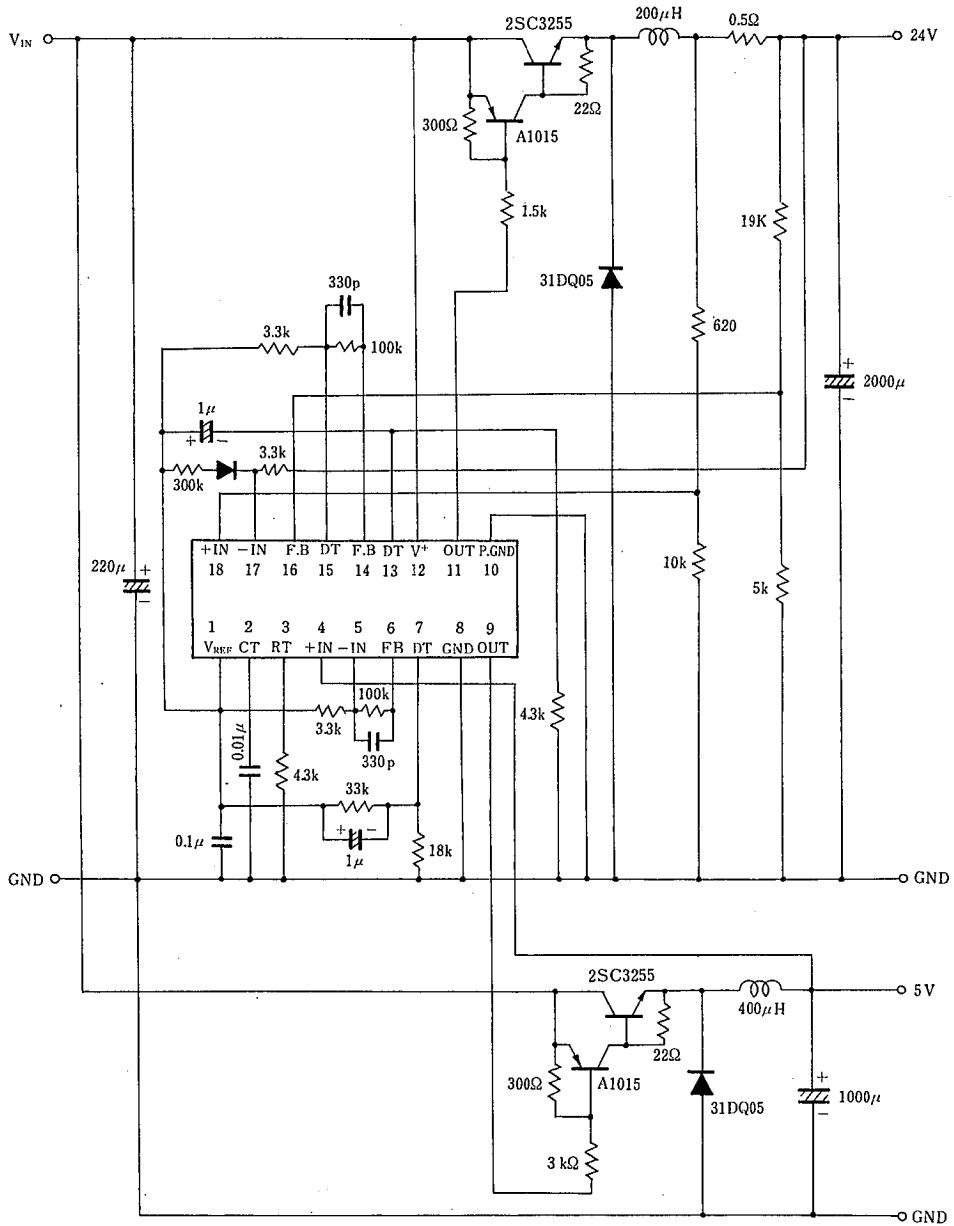

6

## TYPICAL CHARACTERISTICS

**Output Disable Voltage at Low Input Voltage**

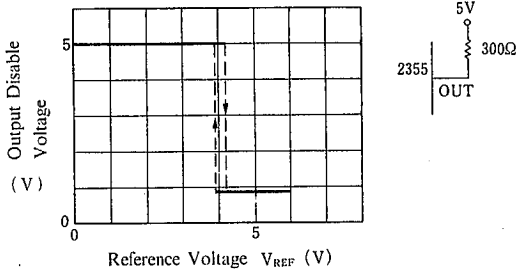

**Output Disable Voltage at Low Input Voltage vs. Temperature**

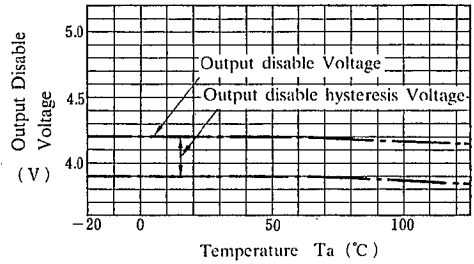

**Operating Current vs. Operating Voltage**

( $I_{REF} = 0 \text{ mA}$ )

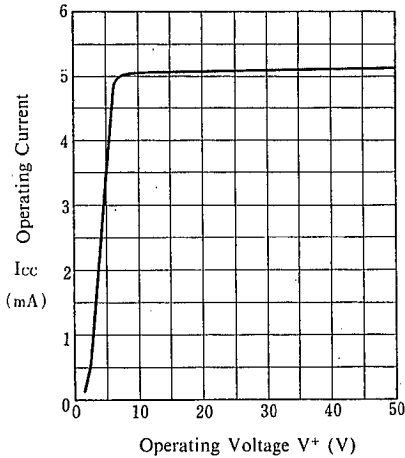

**Reference Voltage vs. Operating Voltage**

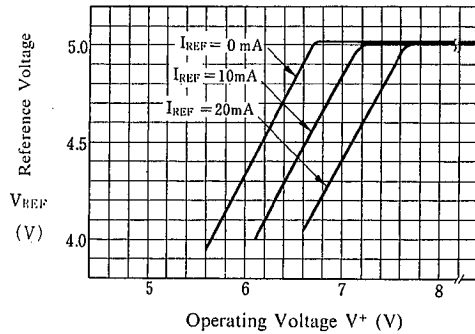

**Reference Voltage vs. Temperature**

( $V_{cl} = 15 \text{ V}$ ,  $I_{REF} = 0 \text{ mA}$ )

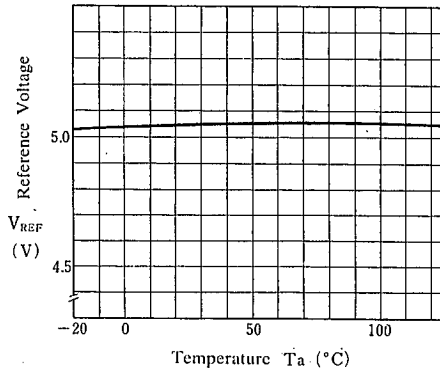

**Oscillation Frequency vs.  $R_t$ ,  $C_t$**

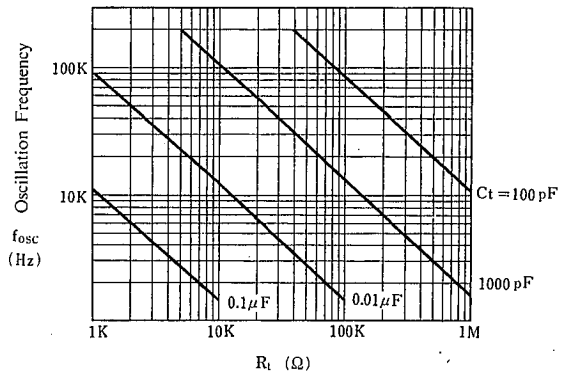

6



■ TYPICAL CHARACTERISTICS

Oscillation Frequency vs. Temperature

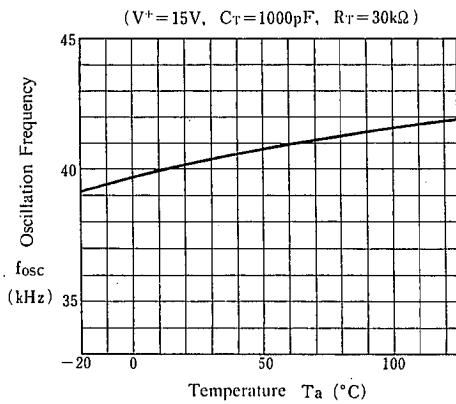

Open Loop Voltage Gain vs. Frequency

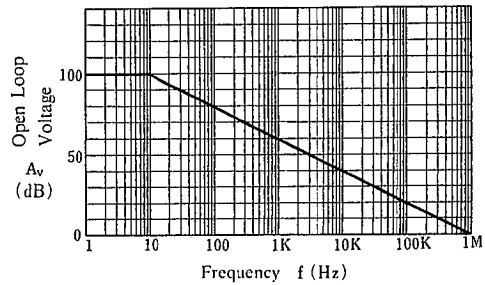

< Error Amplifier Section >

Output Sink Current vs. Feedback Terminal Voltage

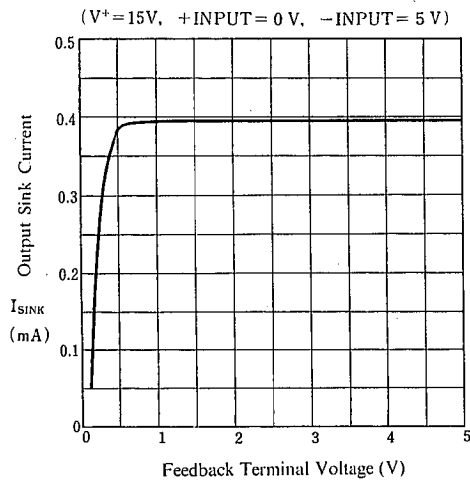

< Error Amplifier Section >

Output Source Current vs. Feedback Terminal Voltage

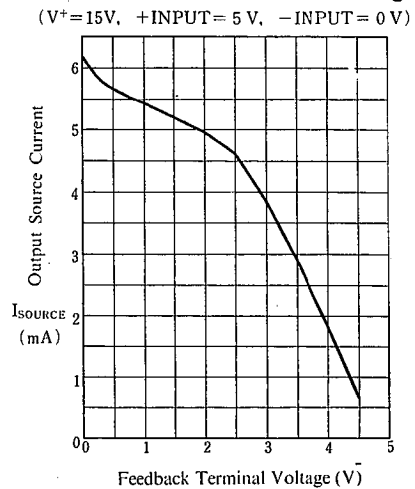

< Error Amplifier Section >

Output Sink Current vs. Temperature

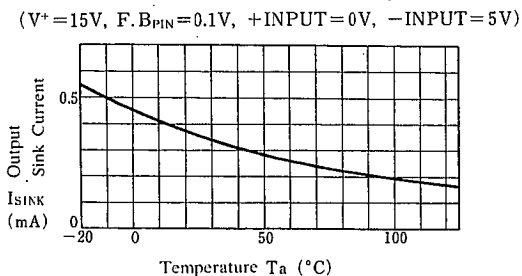

< Error Amplifier Section >

Output Source Current vs. Temperature

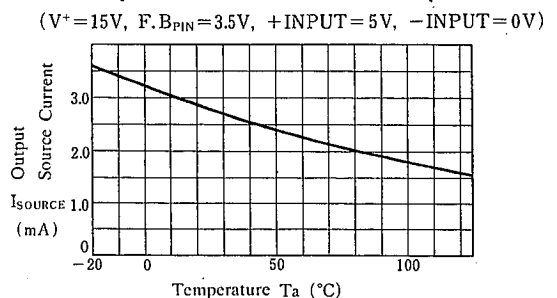

## ■ TYPICAL CHARACTERISTICS

< Output Section >  
Saturation Voltage vs. Output Current  
( $T_a=25^\circ\text{C}$ )

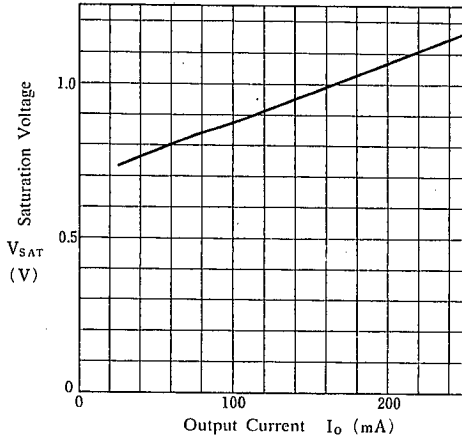

< Output Section >  
Saturation Voltage vs. Temperature  
( $I_o=100\text{mA}$ )

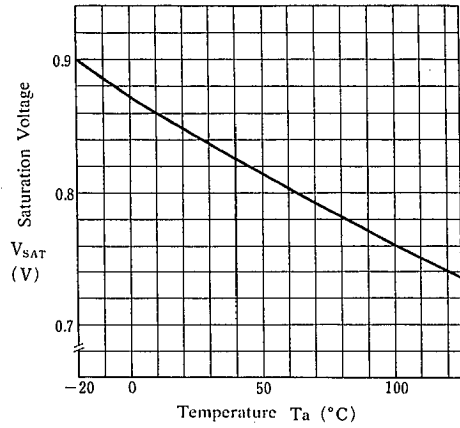

## MEMO

[CAUTION]

The specifications on this databook are only given for information, without any guarantee as regards either mistakes or omissions. The application circuits in this databook are described only to show representative usages of the product and not intended for the guarantee or permission of any right including the industrial rights.