

## SWITCHING REGULATOR CONTROL IC FOR FLYBACK WITH CURRENT SENSE AMPLIFIER

### ■GENERAL DESCRIPTION

The **NJM2382** is a low voltage operation switching regulator control IC.

It features totem pole output directly driving external bipolar transistor and operates at high switching frequency which improves transient response. In addition, low power standby function is incorporated.

It is suitable for LCD back light, and other portable applications.

### ■PACKAGE OUTLINE

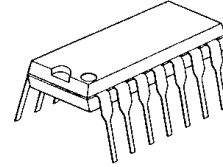

**NJM2382D**

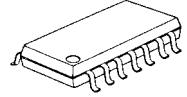

**NJM2382M**



**NJM2382V**

### ■FEATURES

- PWM switching control
- Operating Voltage (3.6 to 32V)
- Wide Oscillator Range (5 to 350 kHz)
- ON/OFF Circuit (High Active)
- Current Sensing Amplifier
- Soft-Start Function
- UVLO(Under Voltage Lockouts)
- Bipolar Technology
- Package Outline DIP14, DMP14, SSOP10

### ■PIN CONFIGURATION

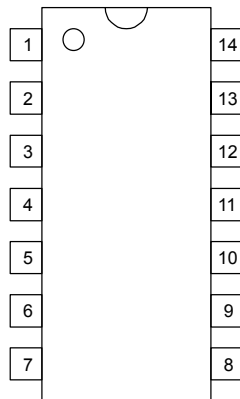

**NJM2382D**

**NJM2382M**

#### PIN FUNCTION

|                     |                   |
|---------------------|-------------------|
| 1.NC                | 8.NC              |
| 2.IN <sup>-</sup> 1 | 9. V <sup>+</sup> |
| 3.IN <sup>-</sup> 2 | 10.CS             |
| 4.F.B               | 11.CT             |
| 5.GND               | 12.REF            |
| 6.OUT               | 13.ON/OFF         |
| 7.NC                | 14.NC             |

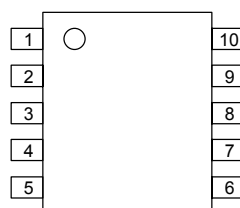

**NJM2382V**

#### PIN FUNCTION

|                     |                   |
|---------------------|-------------------|
| 1.IN <sup>-</sup> 1 | 6. V <sup>+</sup> |
| 2.IN <sup>-</sup> 2 | 7.CS              |
| 3.F.B               | 8.CT              |
| 4.GND               | 9.REF             |
| 5.OUT               | 10.ON/OFF         |

# NJM2382

www.DataSheet4U.com

## ■BLOCK DIAGRAM

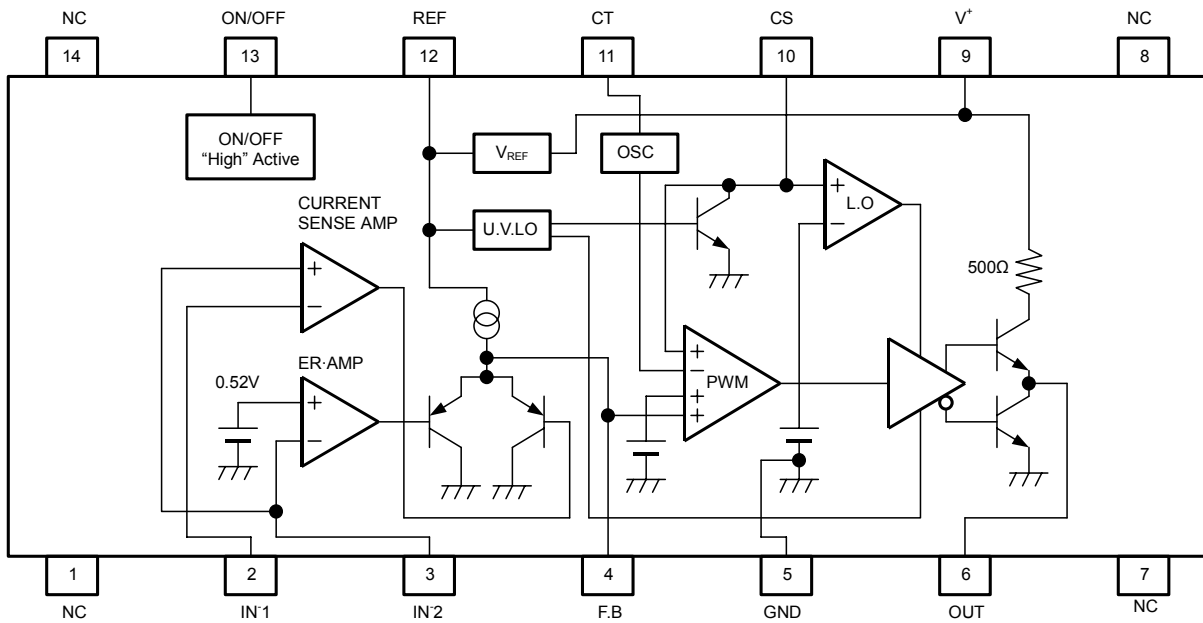

(Package: DIP14, DMP14)

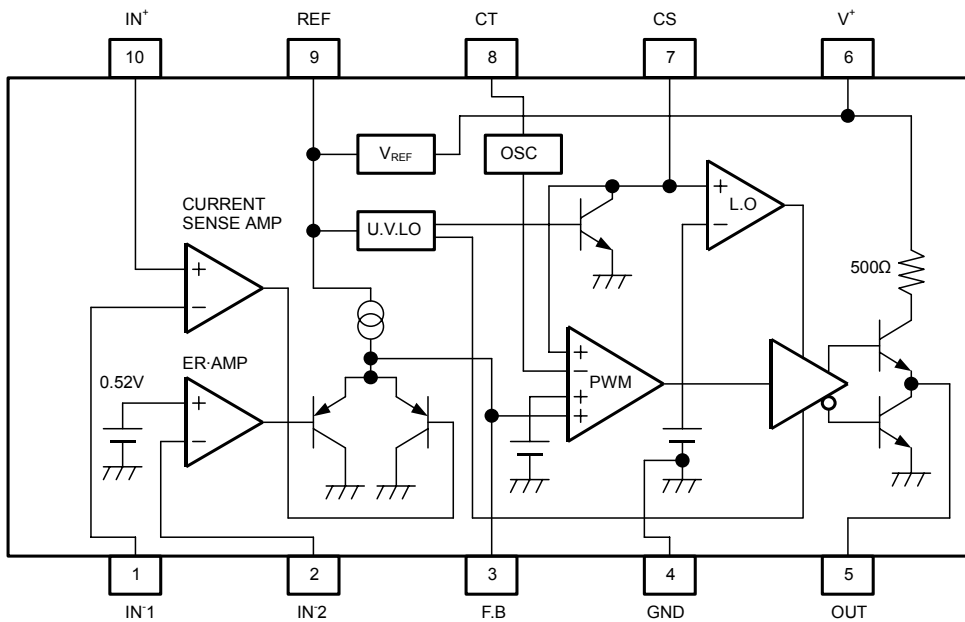

(Package: SSOP10)

## ■ABSOLUTE MAXIMUM RATINGS (Ta=25°C)

| PARAMETER                   | SYMBOL              | MAXIMUM RATINGS                               | UNIT |
|-----------------------------|---------------------|---|------|
| Input Voltage               | V <sup>+</sup>      | 36  | V    |
| Reference Output Current    | I <sub>OR</sub>     | 10  | mA   |
| Output Current              | I <sub>O</sub>      | ±50   | mA   |
| Differential Input Voltage  | V <sub>ID</sub>     | 2.5   | V    |
| Common Mode Input Voltage   | V <sub>IC</sub>     | -0.3 ~ 2.5                                    | V    |
| ON/OFF Control Voltage      | V <sub>ON/OFF</sub> | -0.3 ~ 36 (note)                              | V    |
| Power Dissipation           | P <sub>D</sub>      | (DIP 14) 700<br>(DMP 14) 300<br>(SSOP 10) 250 | mW   |
| Operating Temperature Range | T <sub>OPR</sub>    | -40 ~ +85                                     | °C   |
| Storage Temperature Range   | T <sub>STG</sub>    | -50 ~ +150                                    | °C   |

(note) When the supply voltage is less than 36V, the absolute maximum input voltage is equal to the supply voltage.

## ■ELECTRICAL CHARACTERISTICS (V<sup>+</sup>=6V, R<sub>T</sub>=33kΩ, C<sub>T</sub>=1000pF, V<sub>ON/OFF</sub>=3V, Ta=25°C)

### REFERENCE VOLTAGE BLOCK

| PARAMETER       | SYMBOL           | TEST CONDITION                                  | MIN. | TYP. | MAX. | UNIT |
|-----------------|------------------|---|------|------|------|------|
| Output Voltage  | V <sub>REF</sub> | I <sub>OR</sub> =1mA                            | 2.45 | 2.50 | 2.55 | V    |
| Line Regulation | L <sub>INE</sub> | V <sup>+</sup> =3.6 ~ 32V, I <sub>OR</sub> =1mA | -    | 6.8  | 20.7 | mV   |
| Load Regulation | L <sub>OAD</sub> | I <sub>OR</sub> =0.1 ~ 5.0mA                    | -    | 5    | 30   | mV   |

### OSCILLATOR BLOCK

| PARAMETER                                      | SYMBOL           | TEST CONDITION                               | MIN. | TYP. | MAX. | UNIT |
|--|------------------|--|------|------|------|------|
| Oscillation Frequency                          | f <sub>OSC</sub> | R <sub>T</sub> =33kΩ, C <sub>T</sub> =1000pF | 85   | 105  | 125  | kHz  |
| Oscillate Fluctuations1<br>(Line Fluctuations) | f <sub>dV</sub>  | V <sup>+</sup> =3.6 ~ 32V                    | -    | 1    | -    | %    |
| Oscillate Fluctuations2<br>(Temp Fluctuations) | f <sub>dT</sub>  | Ta=-40 ~ 85°C                                | -    | 5    | -    | %    |

### CURRENT SENSE AMPLIFIER BLOCK

| PARAMETER                            | SYMBOL            | TEST CONDITION         | MIN. | TYP.                         | MAX. | UNIT |
|--------------------------------------|-------------------|------------------------|------|------------------------------|------|------|
| Input Offset Voltage1                | V <sub>IO1</sub>  |                        | -    | 2                            | 7    | mV   |
| Input Offset Current1                | I <sub>IO1</sub>  |                        | -    | 5                            | -    | nA   |
| Input Bias Current1                  | I <sub>B1</sub>   |                        | -    | 20                           | 100  | nA   |
| Open Loop Gain1                      | A <sub>V1</sub>   |                        | -    | 90                           | -    | dB   |
| Gain Bandwidth Product1              | G <sub>B1</sub>   |                        | -    | 0.6                          | -    | MHz  |
| Input Common Mode<br>Voltage Ratio1  | V <sub>ICM1</sub> |                        | -    | 0 ~<br>V <sub>REF</sub> -0.8 | -    | V    |
| Maximum Output Voltage1<br>(F.B Pin) | V <sub>OM-1</sub> | R <sub>NF</sub> =100kΩ | -    | -                            | 1    | V    |
| Maximum Source Current1<br>(F.B Pin) | I <sub>OM+1</sub> | V <sub>OM</sub> =0.5V  | 40   | 85                           | 200  | μA   |

# NJM2382

www.DataSheet4U.com

■ELECTRICAL CHARACTERISTICS ( $V^+=6V, R_T=33k\Omega, C_T=1000pF, V_{ON/OFF}=3V, T_a=25^\circ C$ )

## ERROR AMPLIFIER BLOCK

| PARAMETER  | SYMBOL     | TEST CONDITION      | MIN. | TYP. | MAX. | UNIT    |
|--|------------|---------------------|------|------|------|---------|
| Reference Voltage <sub>2</sub>                   | $V_{B2}$   |                     | 0.51 | 0.52 | 0.53 | V       |
| Input Bias Current <sub>2</sub>                  | $I_{B2}$   |                     | –    | 5    | 100  | nA      |
| Open Loop Gain <sub>2</sub>                      | $A_{v2}$   |                     | –    | 90   | –    | dB      |
| Gain Bandwidth Product <sub>2</sub>              | $G_{B2}$   |                     | –    | 0.6  | –    | MHz     |
| Maximum Output Voltage <sub>2</sub><br>(F.B Pin) | $V_{OM-2}$ | $R_{NF}=100k\Omega$ | –    | –    | 1    | V       |
| Maximum Source Current <sub>2</sub><br>(F.B Pin) | $I_{OM+2}$ | $V_{OM}=0.5V$       | 40   | 85   | 200  | $\mu A$ |

## PWM COMPARATE BLOCK

| PARAMETER                            | SYMBOL     | TEST CONDITION  | MIN. | TYP. | MAX. | UNIT |
|--------------------------------------|------------|---|------|------|------|------|
| Input Threshold Voltage<br>(F.B Pin) | $V_{TH0}$  | duty·cycle=0%   | –    | 1.65 | 1.75 | V    |
| Input Threshold Voltage<br>(F.B Pin) | $V_{TH50}$ | duty·cycle=50%  | –    | 1.88 | –    | V    |
| Maximum Duty Cycle                   | $\alpha M$ | Current Sense Amp.=HIGH<br>Error Amp.=HIGH, CS Pin=1.2V | 55   | 64   | 85   | %    |

## SOFT START CIRCUIT BLOCK

| PARAMETER                           | SYMBOL       | TEST CONDITION | MIN. | TYP. | MAX. | UNIT |
|-------------------------------------|--------------|----------------|------|------|------|------|
| Input Bias Current<br>(CS Pin)      | $I_{BCS}$    | CS Pin=1.8V    | –    | 250  | 650  | nA   |
| Input Threshold Voltage<br>(CS Pin) | $V_{THCS0}$  | duty·cycle=0%  | –    | 0.25 | 0.35 | V    |
| Input Threshold Voltage<br>(CS Pin) | $V_{THCS50}$ | duty·cycle=50% | –    | 0.52 | –    | V    |

## UNDER VOLTAGE LOCKOUT BLOCK

| PARAMETER             | SYMBOL      | TEST CONDITION | MIN. | TYP. | MAX. | UNIT |
|-----------------------|-------------|----------------|------|------|------|------|
| ON Threshold Voltage  | $V_{THON}$  |                | –    | 2.70 | –    | V    |
| OFF Threshold Voltage | $V_{THOFF}$ |                | –    | 2.52 | –    | V    |
| Hysteresis Voltage    | $V_{HYS}$   |                | 60   | 180  | –    | mV   |

## OUTPUT BLOCK

| PARAMETER                          | SYMBOL       | TEST CONDITION           | MIN. | TYP. | MAX. | UNIT |
|------------------------------------|--------------|--------------------------|------|------|------|------|
| H-Output Voltage (OUT Pin)         | $V_{OH}$     | $R_L=10k\Omega$          | 3.50 | 4.00 | –    | V    |
| L-Output Voltage (OUT Pin)         | $V_{OL}$     | Output Sink Current=20mA | –    | 0.25 | 0.65 | V    |
| Output Source Current<br>(OUT Pin) | $I_{SOURCE}$ | OUT Pin=0V               | 8    | 11   | –    | mA   |

■ ELECTRICAL CHARACTERISTICS ( $V^+=6V, R_T=33k\Omega, C_T=1000pF, V_{ON/OFF}=3V, T_a=25^\circ C$ )

ON/OFF BLOCK

| PARAMETER                          | SYMBOL       | TEST CONDITION  | MIN. | TYP. | MAX. | UNIT    |
|------------------------------------|--------------|-----------------|------|------|------|---------|
| OFF Threshold Voltage (ON/OFF Pin) | $V_{OFF}$    |                 | -    | -    | 0.3  | V       |
| ON Threshold Voltage (ON/OFF Pin)  | $V_{ON}$     |                 | 1.1  | -    | -    | V       |
| Input Bias Current (ON/OFF Pin)    | $I_{ON/OFF}$ | $V_{ON/OFF}=3V$ | -    | 100  | 120  | $\mu A$ |

GENERAL CHARACTERISTICS

| PARAMETER                             | SYMBOL       | TEST CONDITION                 | MIN. | TYP. | MAX. | UNIT    |
|---------------------------------------|--------------|--------------------------------|------|------|------|---------|
| Standby Current                       | $I_{CCSTBY}$ | Standby Mode, $V_{ON/OFF}=0V$  | -    | 12   | 20   | $\mu A$ |
| Latch Mode Threshold Voltage (CS Pin) | $V_{THLA}$   |                                | 1.2  | 1.5  | 1.8  | V       |
| Quiescent Current                     | $I_{CCLA}$   | Latch Mode                     | -    | 1.6  | 2.2  | mA      |
| Average Quiescent Current             | $I_{CCAV}$   | $RL = \infty$ , duty-cycle=50% | -    | 3.5  | 4.8  | mA      |

■ TYPICAL APPLICATIONS

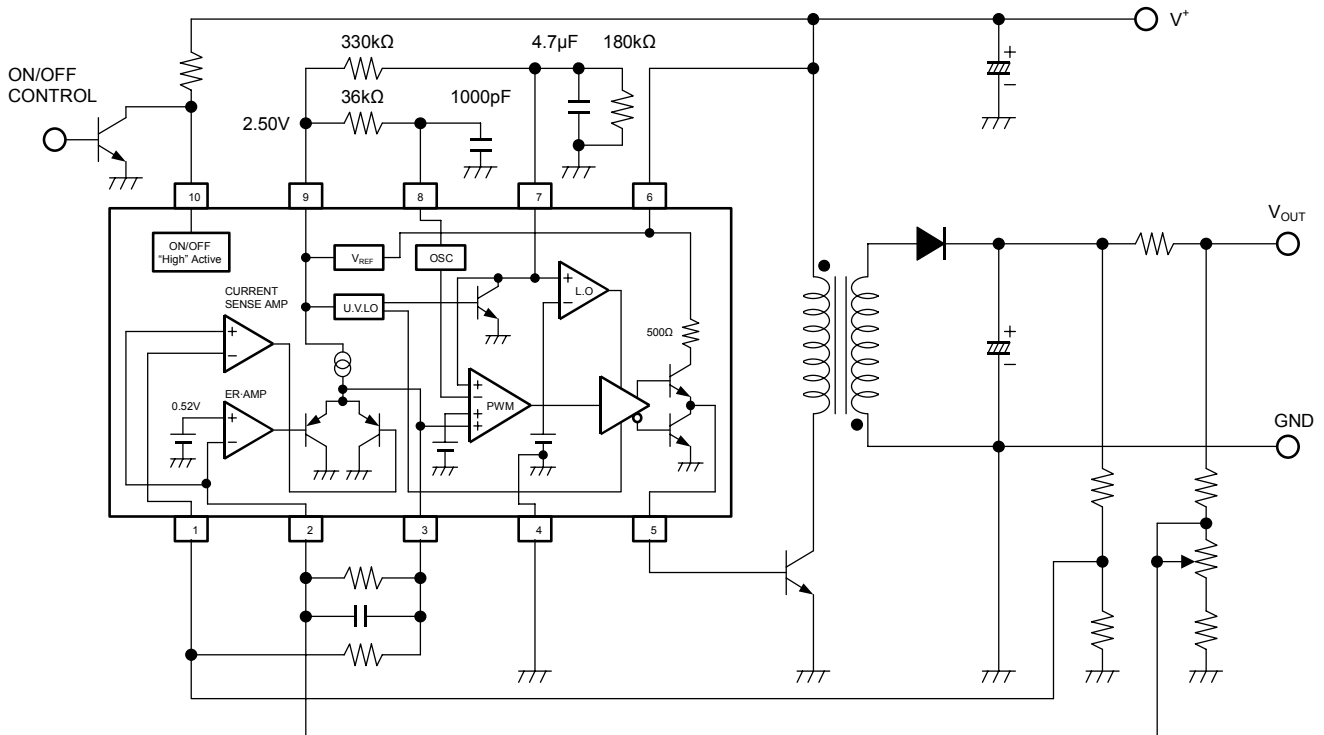

(Package:SSOP10)

## TYPICAL CHARACTERISTICS

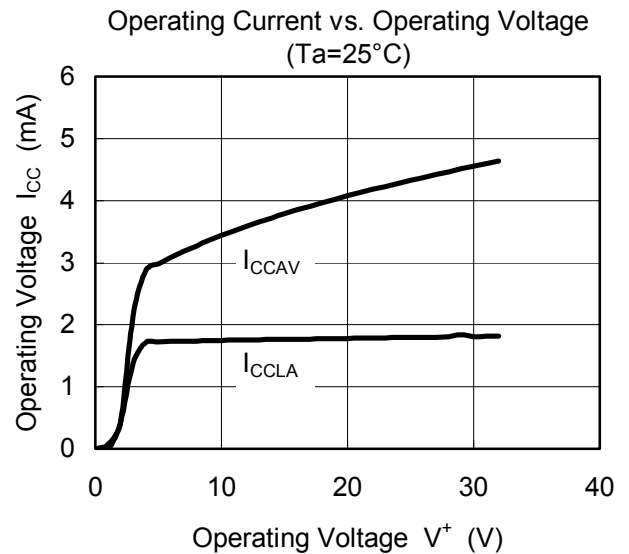
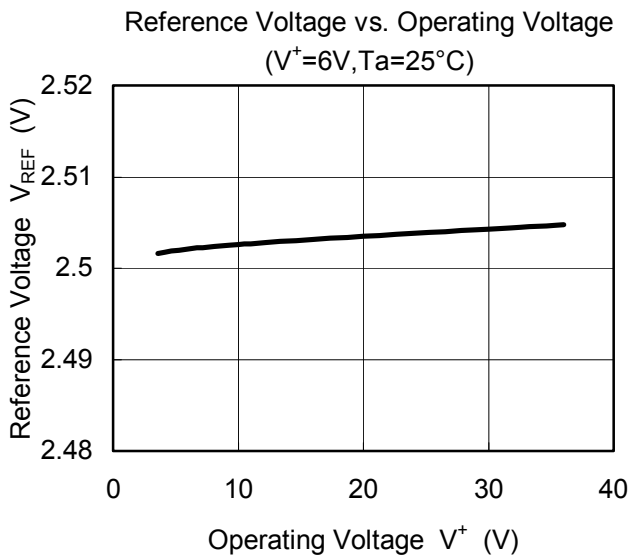
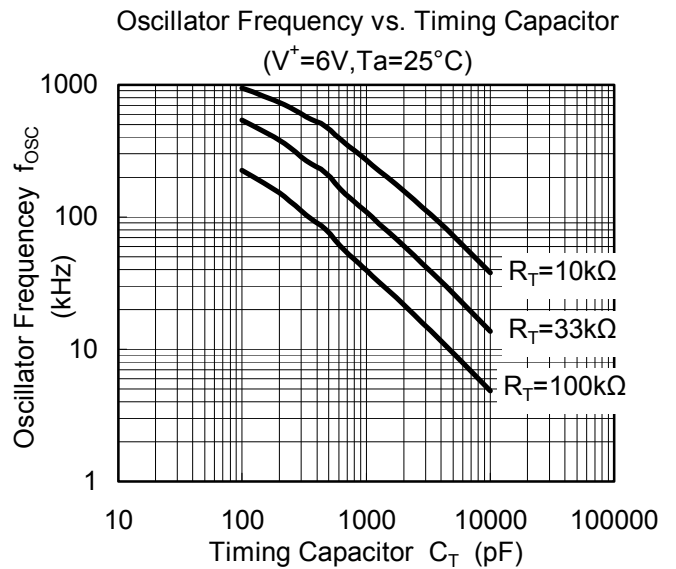
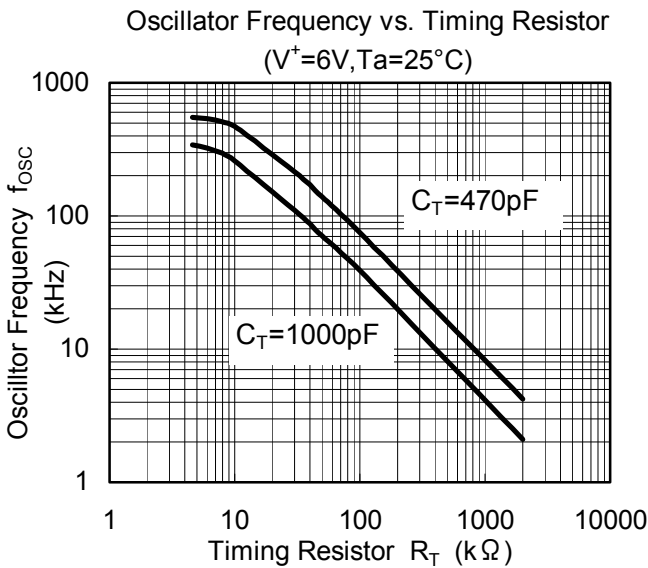
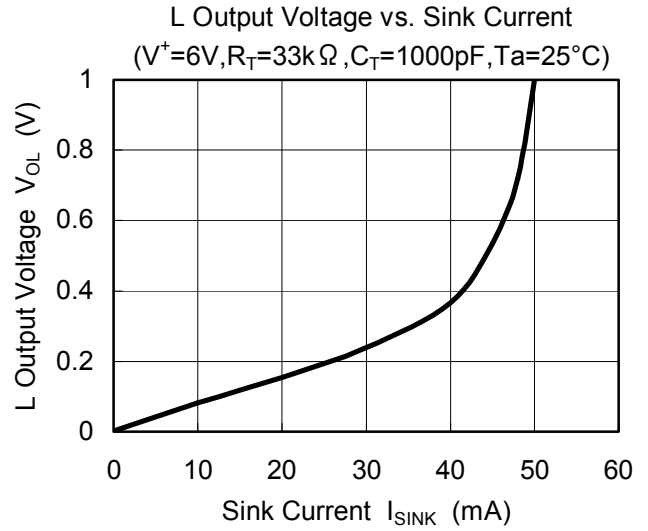
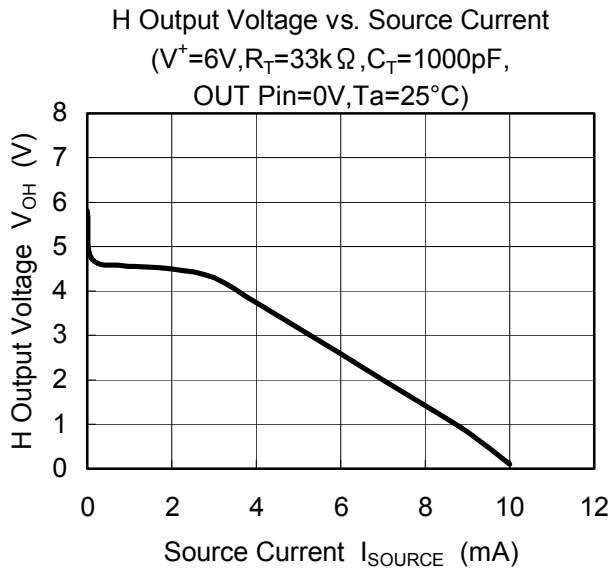

## ■ TYPICAL CHARACTERISTICS

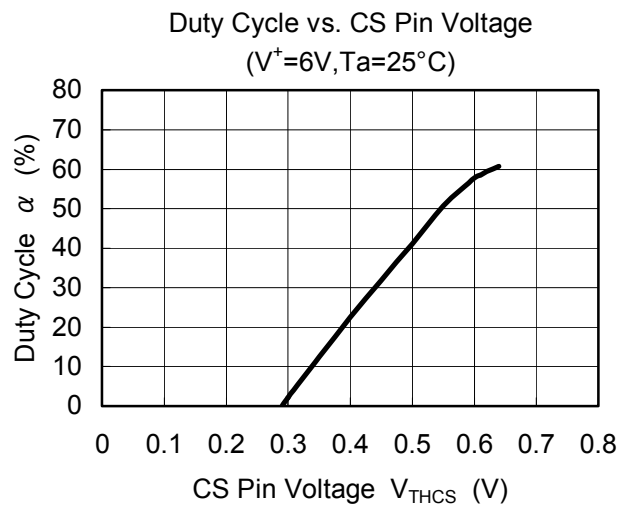
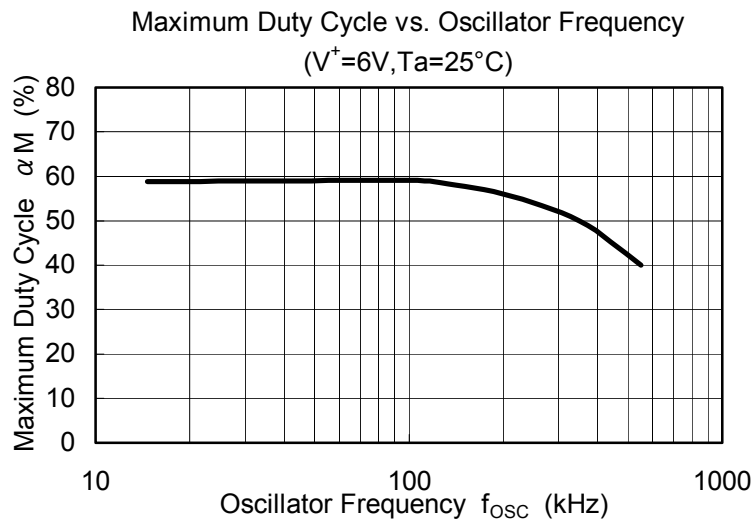

## TYPICAL CHARACTERISTICS

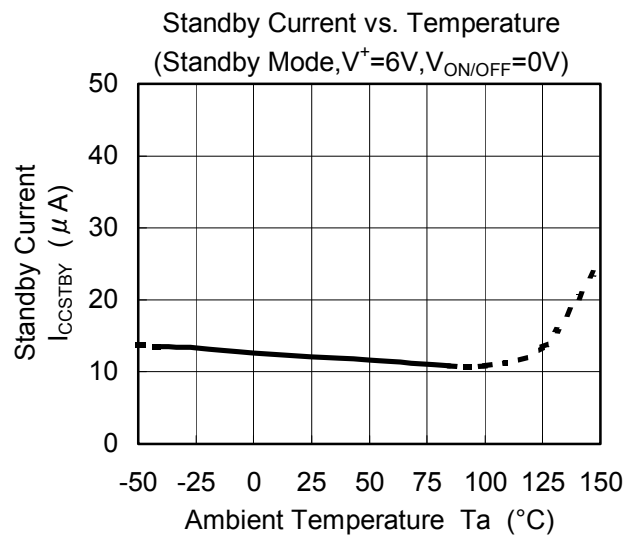
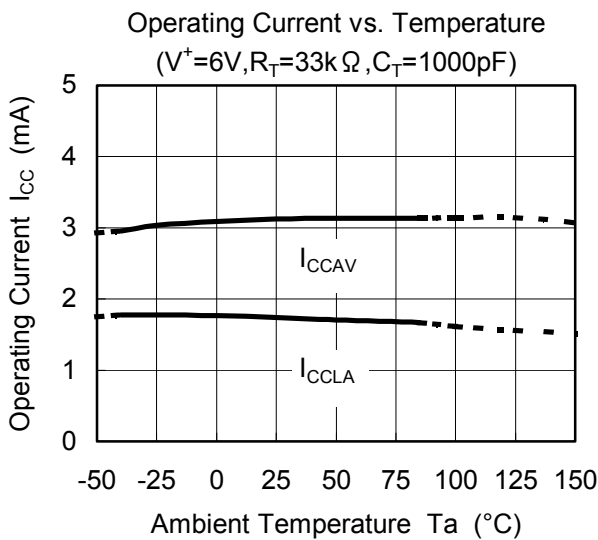
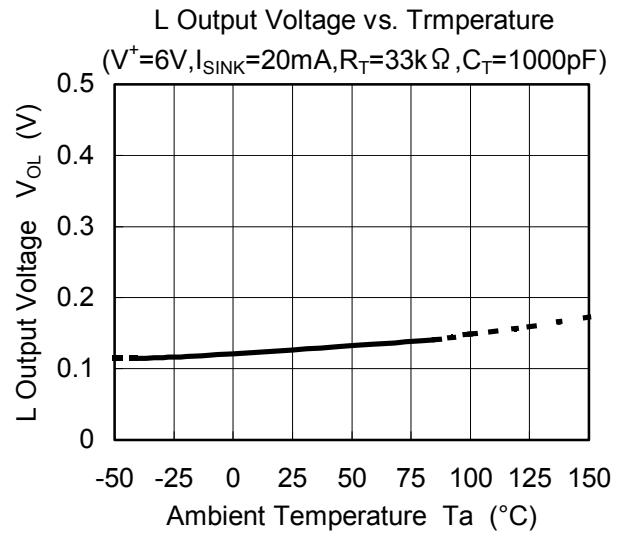
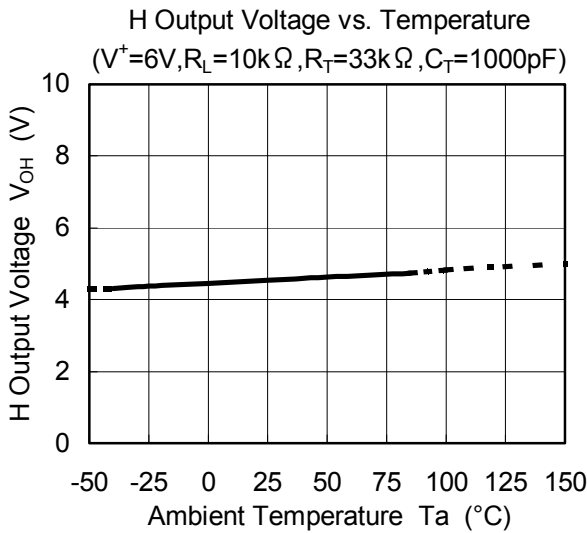
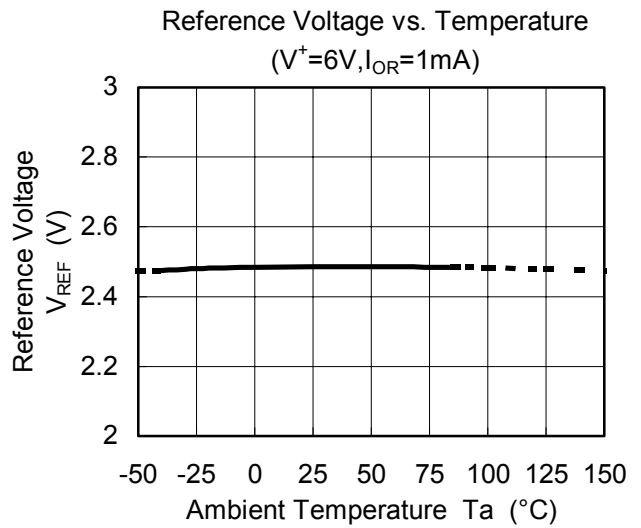
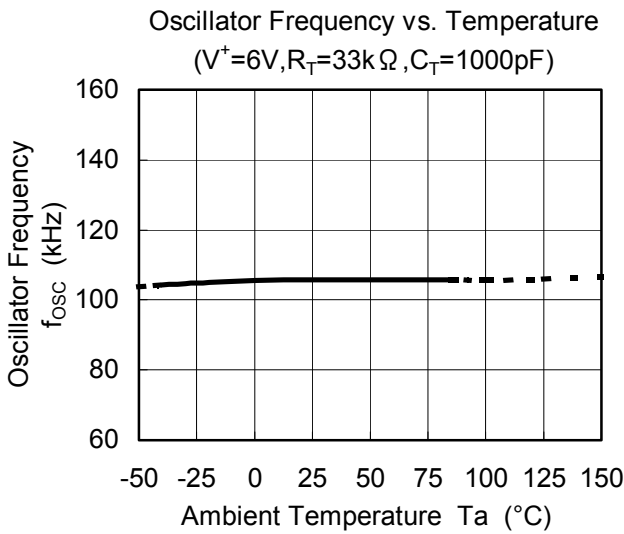



## MEMO

[CAUTION]  
The specifications on this databook are only given for information, without any guarantee as regards either mistakes or omissions. The application circuits in this databook are described only to show representative usages of the product and not intended for the guarantee or permission of any right including the industrial rights.