

## VIF/SIF Demodulator

### DESCRIPTION

The NJM2542 is a VIF/SIF demodulator especially designed for TV and VCR based on the NTSC system.

FM-PLL(Phase Locked Loop) detector reduces the number of pins and external parts, for efficient use of set space.

### PACKAGE OUTLINE

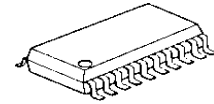

NJM2542V

### FEATURES

- Operating Voltage 5V
- Alignment-free Automatic Frequency Tuning
- Alignment-free FM-PLL Demodulator
- Intercarrier type
- Bipolar Technology
- Package Outline: SSOP20

### BLOCK DIAGRAM

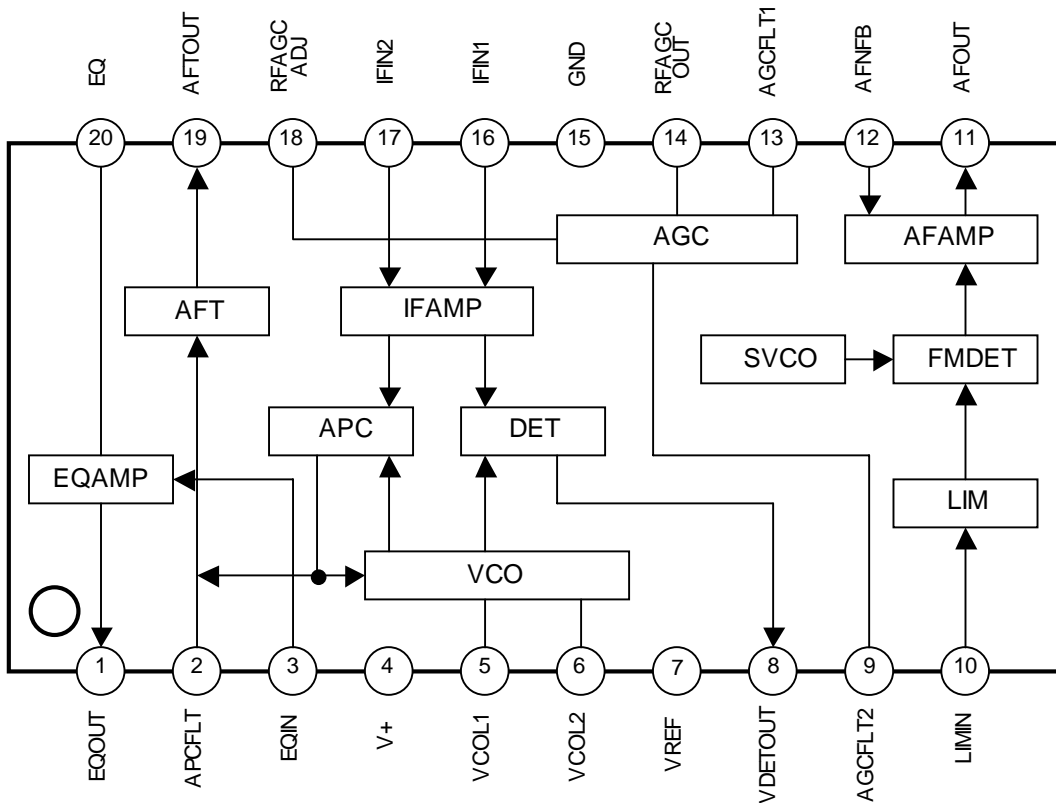

## ■ ABSOLUTE MAXIMUM RATINGS

(T<sub>A</sub>=25°C)

Parameter	Symbol	Ratings	Unit
Supply Voltage	V <sub>cc</sub>	6	V
Power Dissipation	P <sub>D</sub>	*600	mW
Operating Temperature Range	T <sub>opr</sub>	-20 to +80	°C
Storage Temperature Range	T <sub>stg</sub>	-40 to +150	°C

\* Test IC soldered on PC board

## ■ RECOMMENDED OPERATING VOLTAGE RANGE

(T<sub>A</sub>=25°C)

Parameter	Condition	Symbol	Min.	Typ.	Max.	Unit
Operating Voltage		V <sub>cc</sub>	4.75	5.0	5.25	V

## ■ ELECTRICAL CHARACTERISTICS

Standard Test Conditions:

(T<sub>A</sub> =25°C, V<sub>cc</sub>=5V, IF=45.75MHz/90dBuV, IF IN has 1:1Transformer instead of SAW filter.)

Parameter	Condition	Symbol	Min.	Typ.	Max.	Unit
Supply Current	AFT-Defeat IFGR-MAX(AGCFLT=GND)	I <sub>cc</sub>	-	51	-	mA
VIF Section (45.75MHz/90dBuV)						
Video Output Level (DC)	No IF Signal FGR-MAX(AGCFLT=GND)	V <sub>DC</sub>	-	3.6	-	V
Video Output Level	Video : 100% White, 87.5% Mod	V <sub>o</sub>	1.5	1.9	2.3	V <sub>p-p</sub>
Video Bandwidth	-3dB Point	f <sub>vc</sub>	-	7	-	MHz
Video S/N	VIDEO:100% White, 87.5% Mod	Video S/N	50	56	-	dB
Intermodulation	P/C/S=1/-10/-10dB	IM	34	40	50	dB
Differential Gain		DG	-	±2	±7	%
Differential Phase		DP	-	±2	±7	deg
Input Signal Voltage Sensitivity	-3dB Point	V <sub>INMIN</sub>	-	44	52	dBuV
Maximum Input signal Voltage	VS Ratio (>24%, <34%)	V <sub>INMAX</sub>	101	105	-	dBuV
IF Gain Control Range	V <sub>INMAX</sub> -V <sub>INMIN</sub>	GR	49	61	-	dB
RF AGC Maximum Voltage	IFGR-MAX(AGCFLT=GND)	V <sub>RAH</sub>	4.3	4.9	5.0	V
RF AGC Minimum Voltage	IFGR-MIN(AGCFLT=V <sup>+</sup> )	V <sub>RAL</sub>	0	0.03	0.5	V
Picture Carrier Capture Range 1		CL-U	-	1.3	-	MHz
Picture Carrier Capture Range 2		CL-L	-	3.5	-	MHz
AFT Sensivity		S <sub>f</sub>	20	30	-	mV/kHz
AFT Maximum Voltage		V <sub>AFH</sub>	4.2	4.9	5.0	V
AFT minimum Voltage		V <sub>AFH</sub>	0	0.05	0.5	V
Sync Level		V <sub>OSYNC</sub>	-	1.35	-	V
VCO Frequency Range	AFTOUT=2.5V Center=45.65MHz	F <sub>VCOWB</sub>	-	±250	-	kHz
SIF Section(SIF=4.5MHz/90dBuV)						
Audio Output DC Voltage	LIMIN=4.5MHz CW	V <sub>DCA</sub>	1.8	2.2	2.6	V
Audio Output	LIMIN=4.5MHz FM±25kHz dev	V <sub>AFO</sub>	390	540	770	mVrms
Total Harmonic Distortion	LIMIN=4.5MHz FM±25kHz dev	THDAF	-	0.2	1.0	%
Input Limiting Voltage Sensivity		LIM	-	38	-	dBuV
AM Rejection Ratio	FM±25kHzDEV :AM30%	AMR	50	56	-	dB
Audio S/N	De-Emphasis: ON	AF S/N	-	56	-	dB

## ■ PINNING

Pin	Symbol	Description
1	EQOUT	Equalizer AMP Output
2	APCFLT	APC Filter (PLL loop Filter)
3	EQIN	Equalizer AMP Input
4	V+	Power Supply
5	VCOL1	VCO Coil 1
6	VCOL2	VCO Coil 2
7	VREF	Reference Voltage for Audio
8	VDETOUT	Video Demodulator Output
9	AGCFLT2	AGC Filter 2
10	LIMIN	Limiter (sound intercarrier) Input
11	AFOUT	Audio Output
12	AFNFB	Audio High Pass Filter
13	AGCFLT1	AGC Filter 1
14	RFAGCOUT	RF AGC Output
15	GND	GND
16	IFIN1	IF Differential Input 1
17	IFIN2	IF Differential Input 2
18	RFAGCADJ	RF AGC Adjustment
19	AFTOUT	AFT Output
20	EQ	Equalizer



## TYPICAL CHARACTERISTICS

Standard Test Conditions:

( $T_A=25^\circ\text{C}$ ,  $V_{CC}=5\text{V}$ ,  $I_F=45.75\text{MHz}/90\text{dBuV}$ , IF IN has 1:1 Transformer instead of SAW filter.)

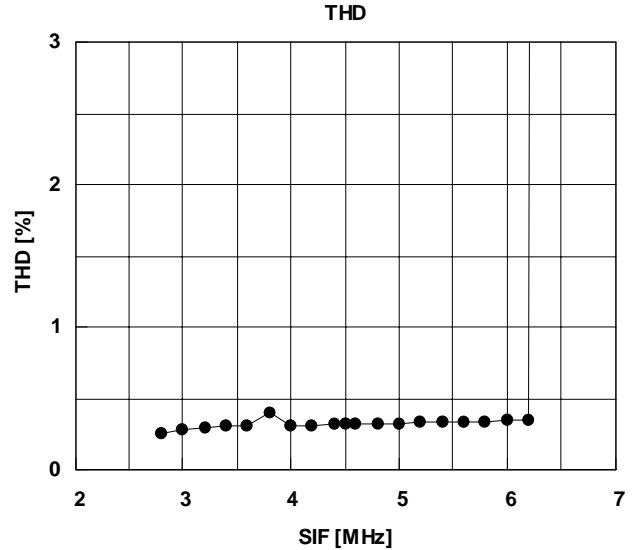
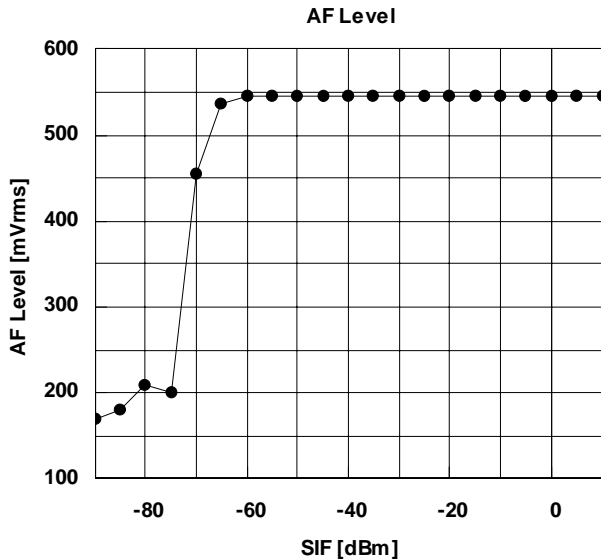
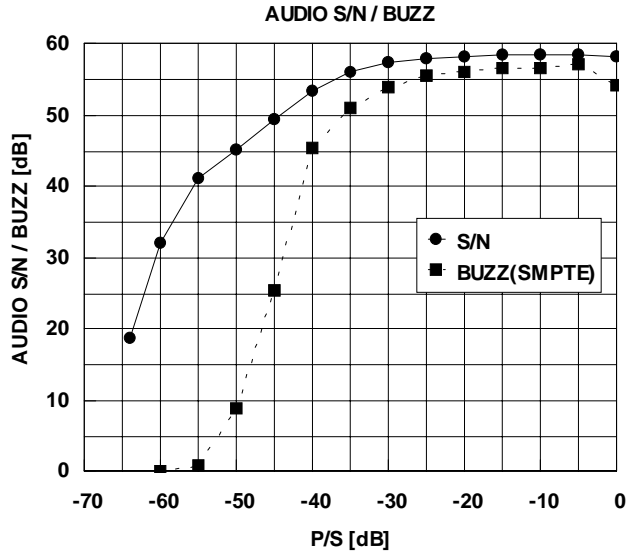
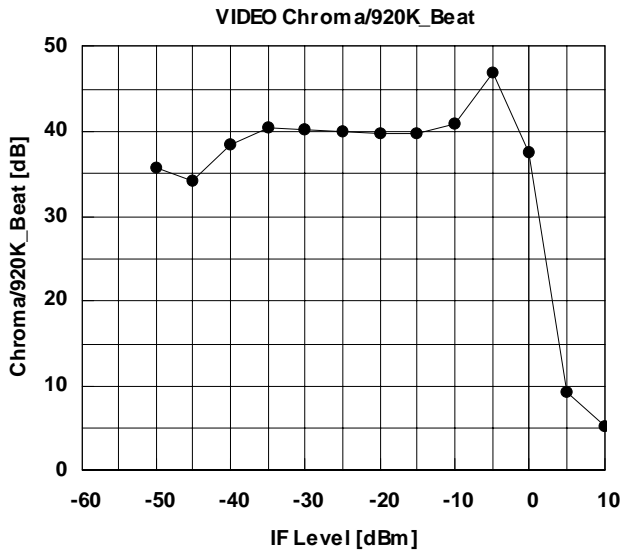
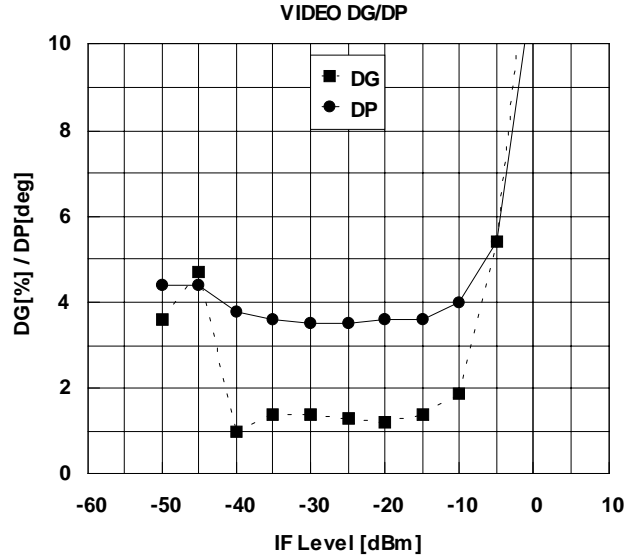
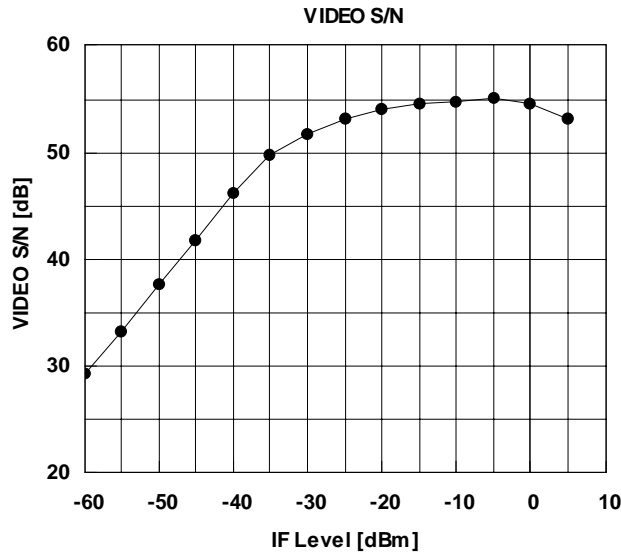

# MEMO

[CAUTION]

The specifications on this databook are only given for information , without any guarantee as regards either mistakes or omissions. The application circuits in this databook are described only to show representative usages of the product and not intended for the guarantee or permission of any right including the industrial rights.