

## LOW VOLTAGE VIDEO AMPLIFIER WITH LPF

### ■GENERAL DESCRIPTION

The NJM2576 is a Low Voltage Video Amplifier contained LPF circuit.  
 The NJM2576 is corresponding to composite video signal input with LPF circuit. 75Ω drivers for direct connecting TV monitor.  
 The NJM2576 features low power and small package, and is suitable for low power design on downsizing of DSC and DVC.

### ■PACKAGE OUTLINE

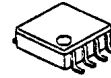

NJM2576RB1

### ■FEATURES

- Operating Voltage 2.8 to 5.5V
- Input Composite Video Signal 0.3Vpp
- Operating Current 8.0mA typ. at Vcc=3.0V
- Operating Current (Power Save Mode) 70uA typ.at Vcc=3.0V
- Internal 75Ω Driver Circuit (2-system drive)
- Internal Low Pass Filter
- Bipolar Technology
- Package Outline TVSP8

### ■BLOCK DIAGRAM

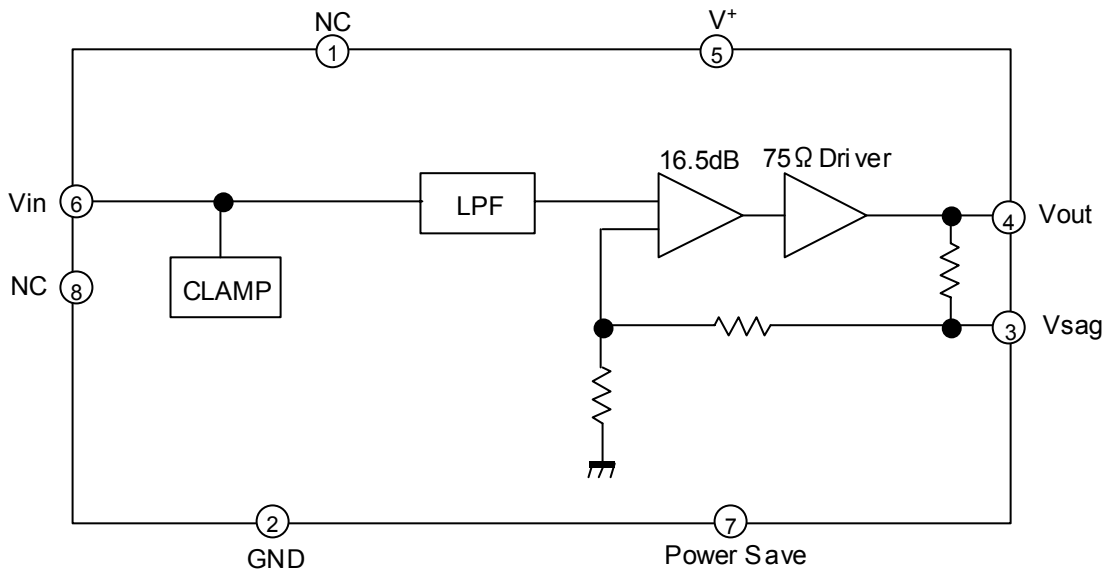

# NJM2576

www.DataSheet4U.com

## ■ ABSOLUTE MAXIMUM RATINGS

(Ta=25°C)

PARAMETER	SYMBOL	RATINGS	UNIT
Supply Voltage	V <sup>+</sup>	7.0	V
Power Dissipation	P <sub>D</sub>	320	mW
Operating Temperature Range	Topr	-40 to +85	°C
Storage Temperature Range	Tstg	-40 to +125	°C

## ■ ELECTRICAL CHARACTERISTICS ( V<sup>+</sup>=3.0V, R<sub>L</sub>=150Ω, Ta=25°C)

PARAMETER	SYMBOL	TEST CONDITION	MIN.	TYP.	MAX.	UNIT
Operating Voltage	Vopr		2.8	3.0	5.5	V
Operating Current	I <sub>CC</sub>	No Signal	-	8.0	11.0	mA
Operating Current at Power Save	I <sub>save</sub>	Power Save Mode	-	70	90	uA
Maximum Output Voltage Swing	Vom	f=1kHz, THD=1%	2.2	2.5	-	Vp-p
Voltage Gain	Gv	Vin=100kHz, 0.3Vp-p, Input Sine Signal	16.1	16.5	16.9	dB
Low Pass Filter Characteristic	Gfy4.5M	Vin=4.5MHz/100kHz, 0.3Vp-p	-0.95	-0.45	0.05	dB
	Gfy8M	Vin=8MHz/100kHz, 0.3Vp-p	-	-2.7	-	
	Gfy23.5M	Vin=23.5MHz/100kHz, 0.3Vp-p	-	-27	-17	
Differential Gain	DG	Vin=0.3Vp-p, Input 10step Video Signal	-	0.5	-	%
Differential Phase	DP	Vin=0.3Vp-p, Input 10step Video Signal	-	0.5	-	deg
S/N Ratio	SNv	Vin=0.3Vp-p, 100k to 6MHz 100% White Video Signal, R <sub>L</sub> =75Ω	-	+60	-	dB
2nd. Distortion	Hv	Vin=0.3Vp-p, 3.58MHz, Sine Video Signal, R <sub>L</sub> =75Ω	-	-60	-	dB
SW Change Voltage High Level	VthPH	Active	1.8	-	V <sup>+</sup>	V
SW Change Voltage Low Level	VthPL	Non-active	0	-	0.3	

## ■ CONTROL TERMINAL

PARAMETER	STATUS	NOTE
Power Save	H	Power Save : OFF
	L	Power Save : ON
	OPEN	Power Save : ON

Ver.1

■ EQUIVALENT CIRCUIT (V+=3V)

PIN No.	PIN NAME	EQUIVALENT CIRCUIT	DC VOLTAGE
1 8	NC		-
2	GND		0V
3	Vsag		0.37
4	Vout		0.33V
5	V+		3V
6	Vin		1.42V
7	PowerSave		0V

# NJM2576

www.DataSheet4U.com

## TEST CIRCUIT

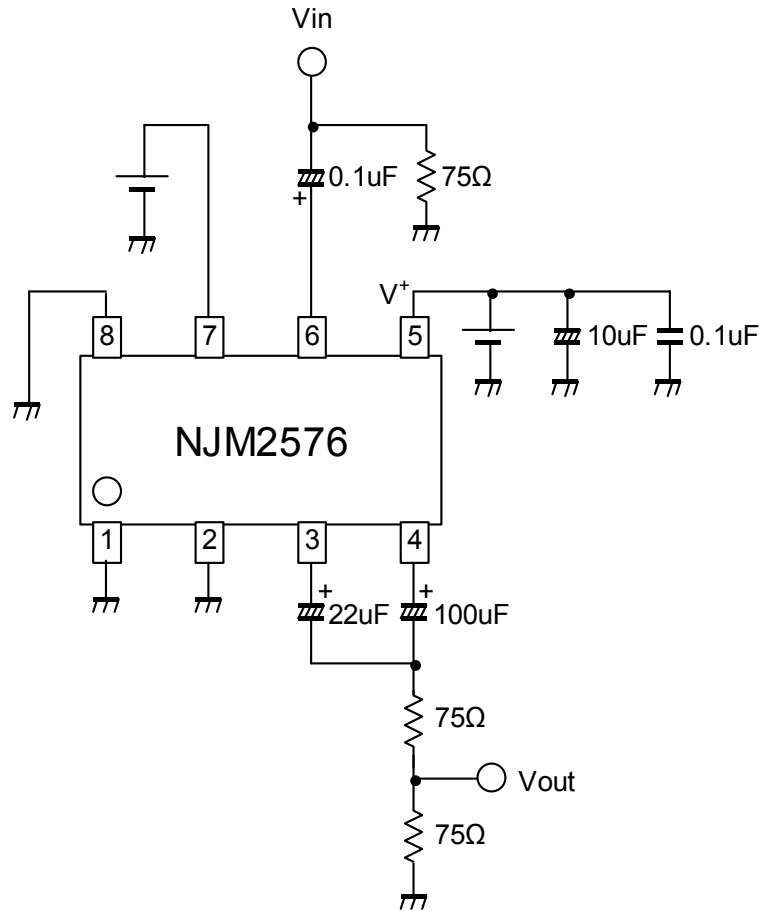

## APPLICATION CIRCUIT

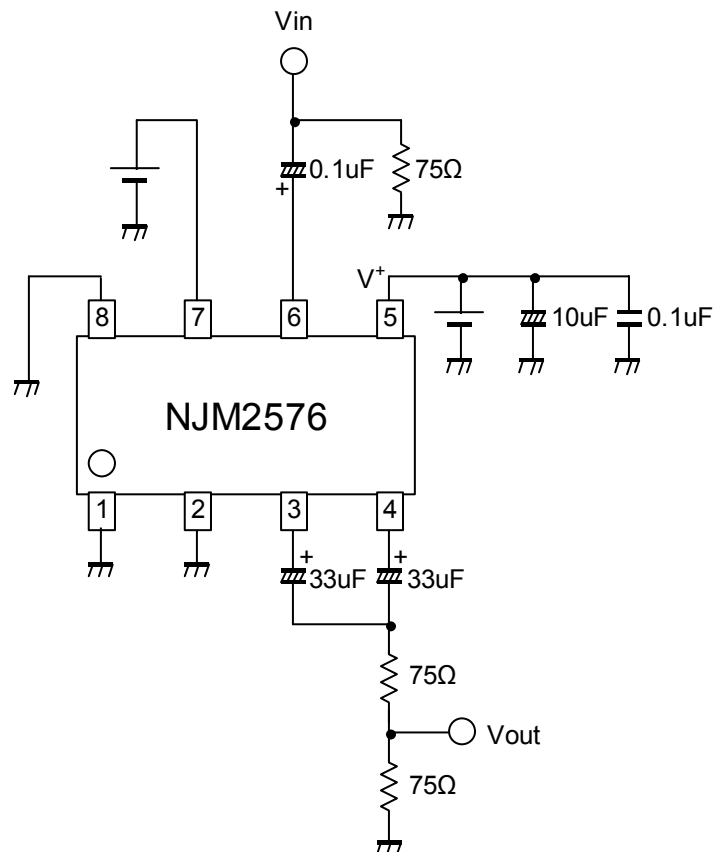

Ver.1

## TYPICAL CHARACTERISTICS

Voltage Gain vs. Frequency  
0.3Vpp sinewave signal input

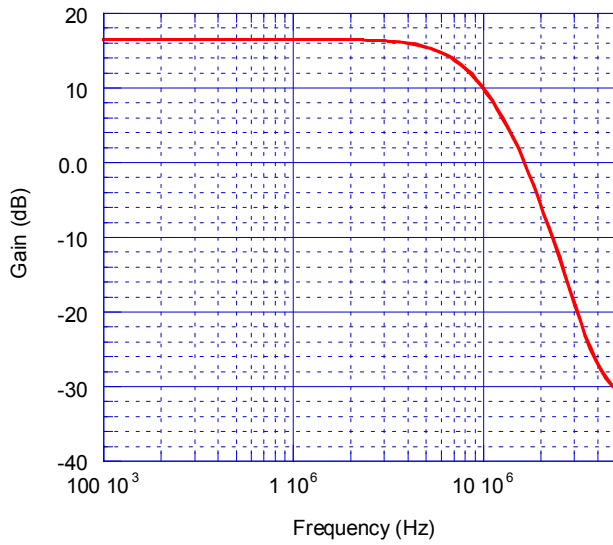

Operating Current vs. Supply Voltage

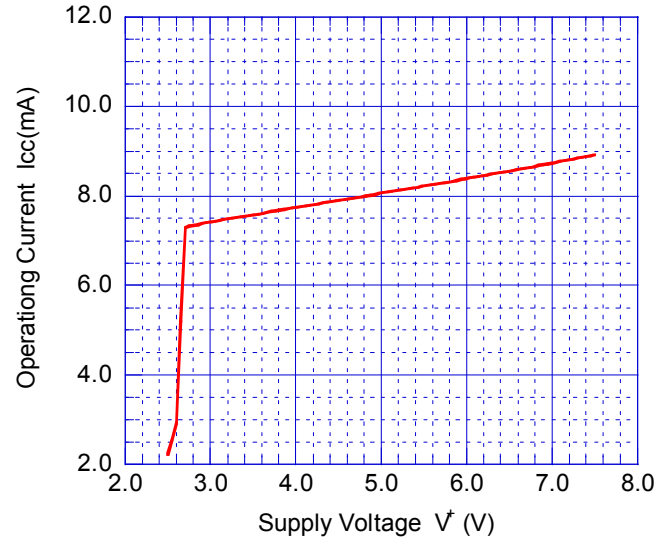

Operating Current at Standby State vs. Supply Voltage

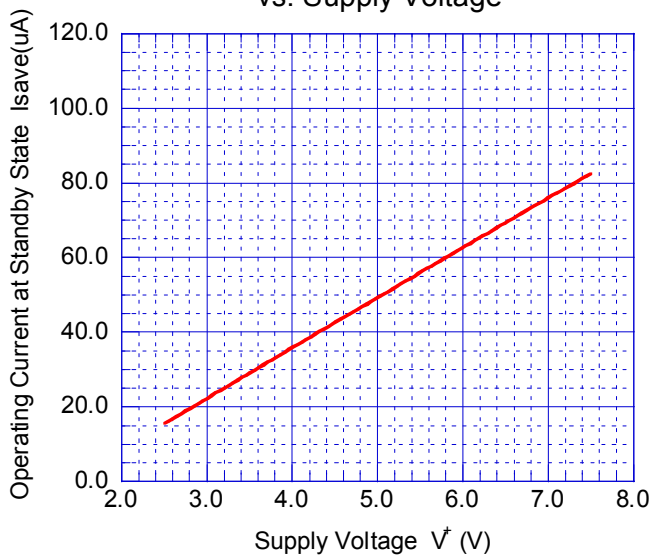

V+ vs Vomv

f=1kHz, THD=1%

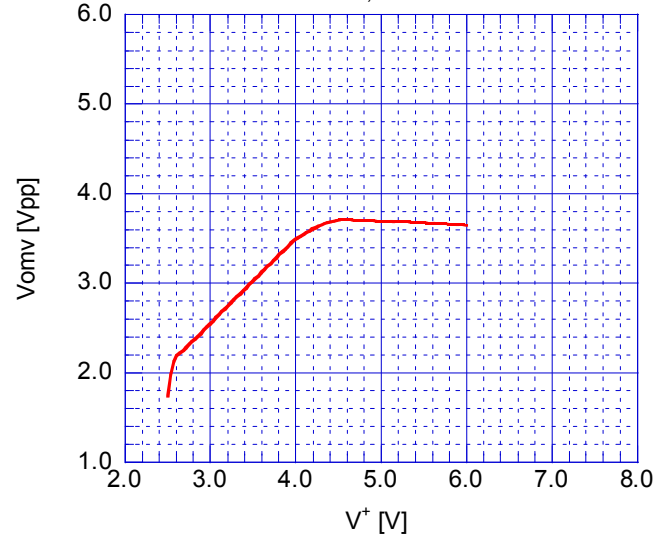

V+ vs Gv

f=100kHz, Vin=0.3Vpp

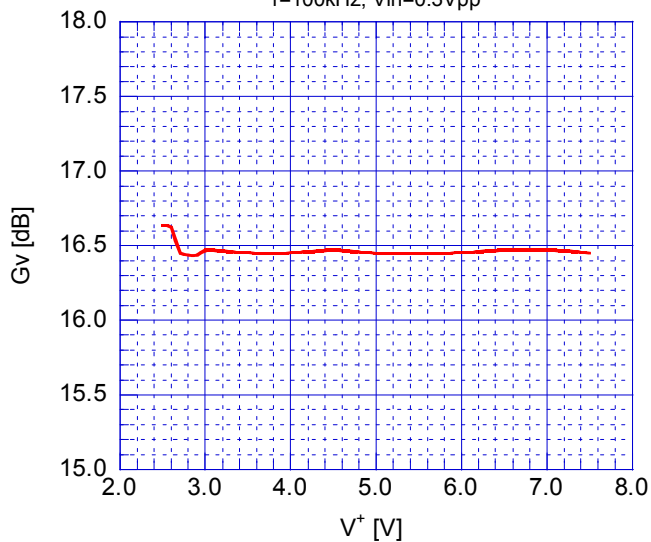

V+ vs Gfy4.5M

f=4.5MHz/100kHz, Vin=0.3Vpp

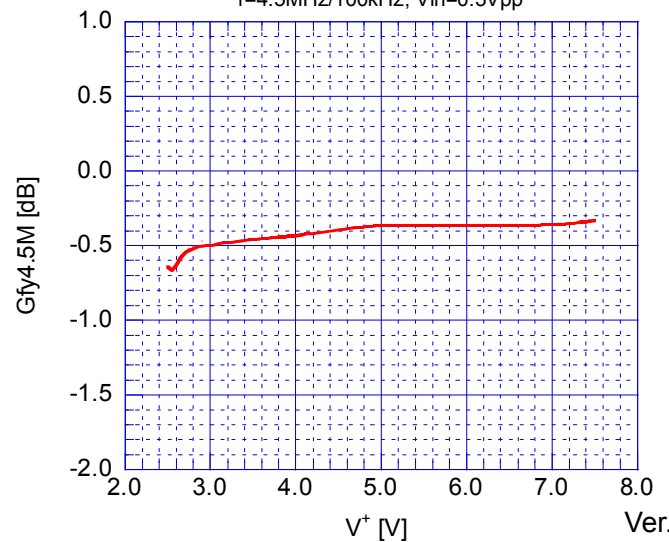

### V<sup>+</sup> vs G<sub>fy8M</sub>

f=8MHz/100kHz, Vin=0.3Vpp

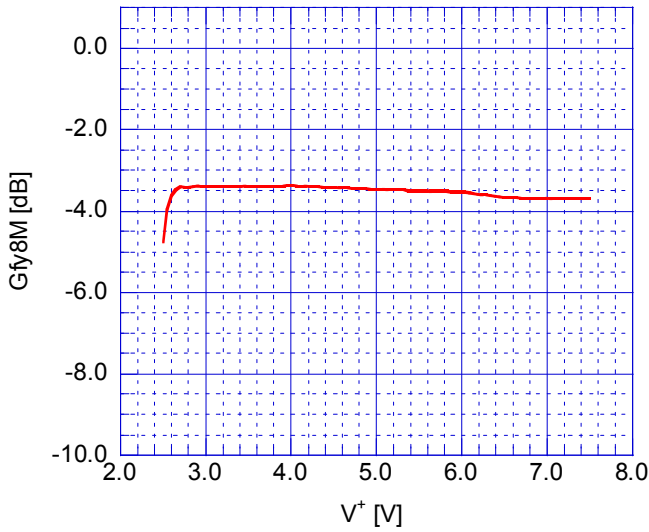

### V<sup>+</sup> vs G<sub>fy23.5M</sub>

f=23.5MHz/100kHz, Vin=0.3Vpp

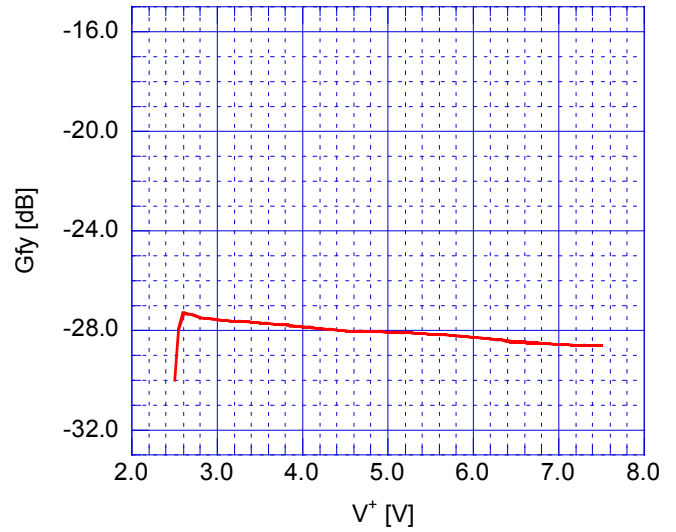

### V<sup>+</sup> vs DG

0.3Vpp, 10step video signal input

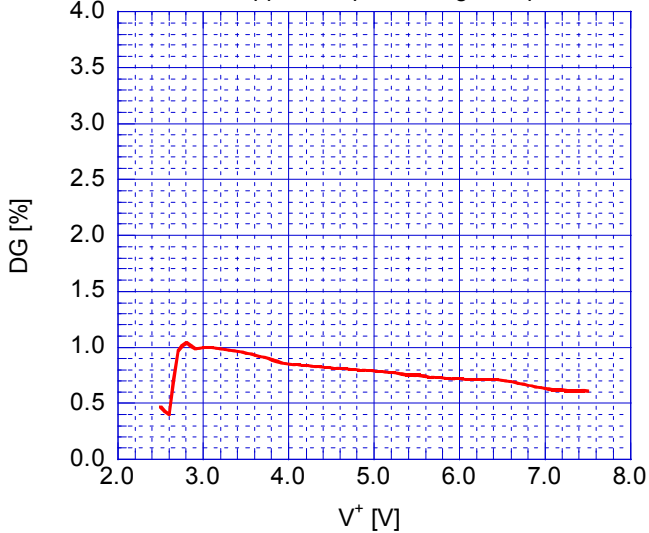

### V<sup>+</sup> vs DP

0.3Vpp, 10step video signal input

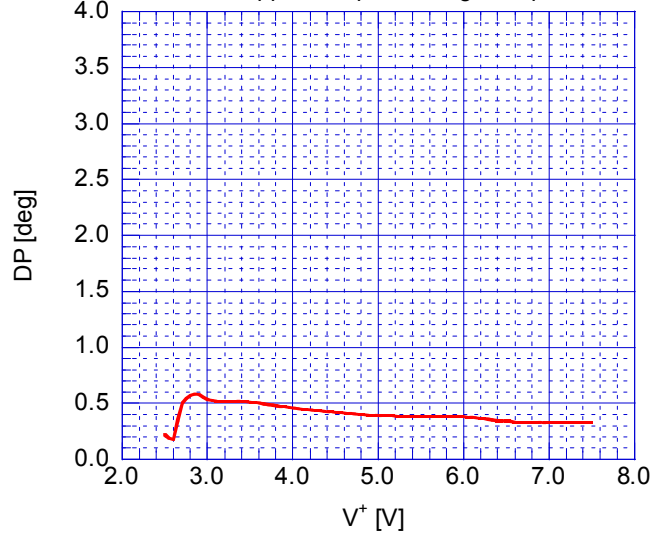

### Signal to Noise Ratio vs. Supply Voltage

0.3Vpp, 100% white video signal input, 100kHz-6MHz

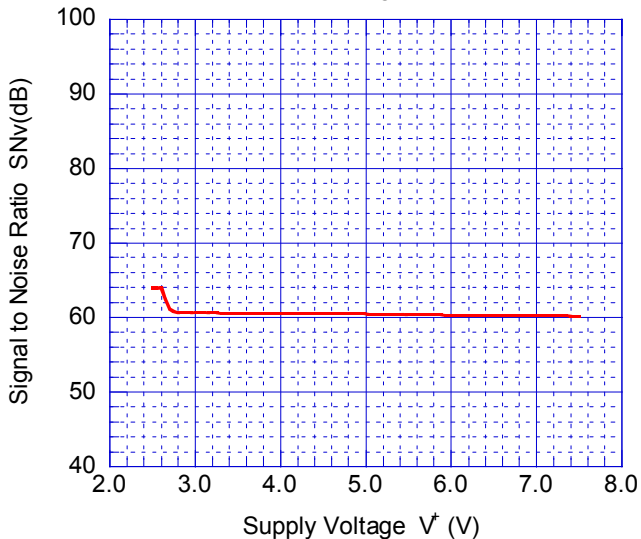

### Second Harmonic Distortion vs. Supply Voltage

0.3Vpp, 3.58MHz sinewave signal input

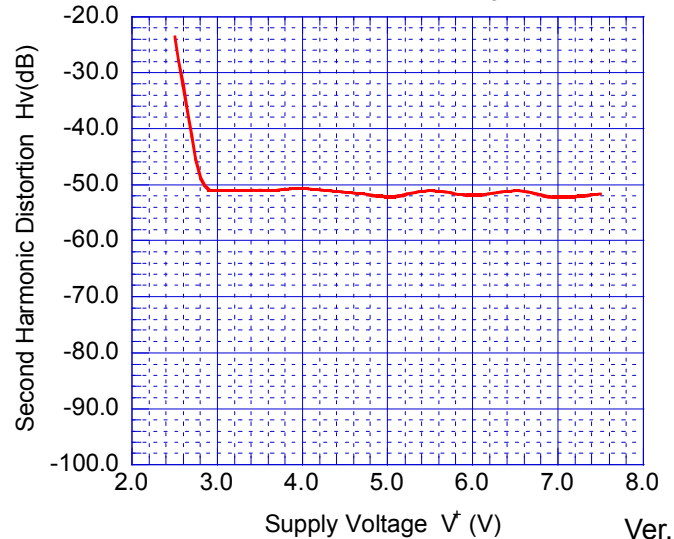

Ver.1

Temperature vs Vomv

f=1kHz, THD=1%

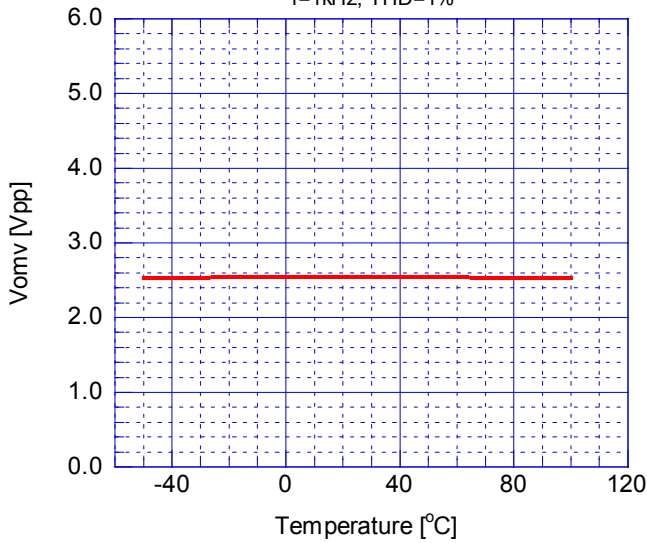

Operating Current vs. Temperature

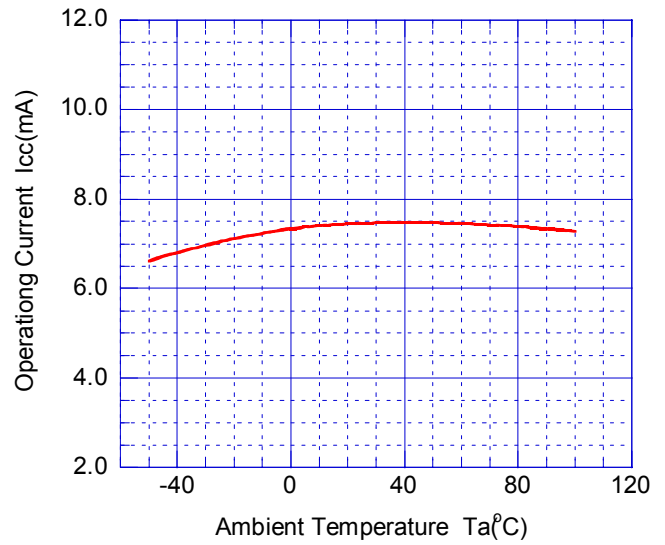

Operating Current at Standby State vs. Temperature

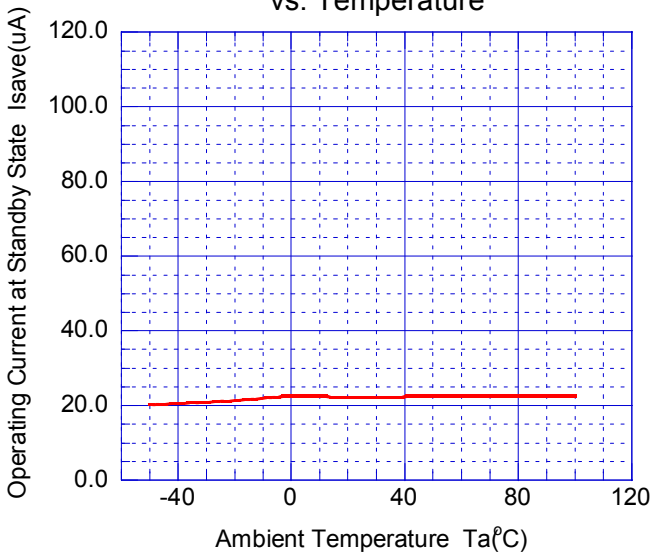

Temperature vs Gv

f=100kHz, Vin=0.3Vpp

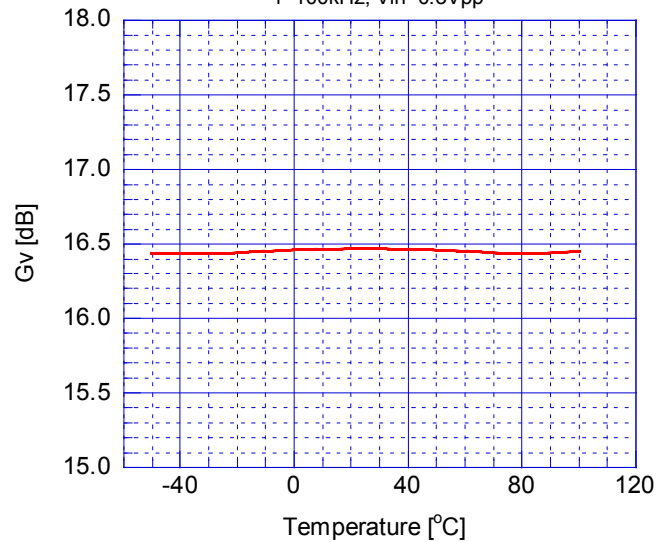

Temperature vs Gfy4.5M

f=4.5MHz/100kHz, Vin=0.3Vpp

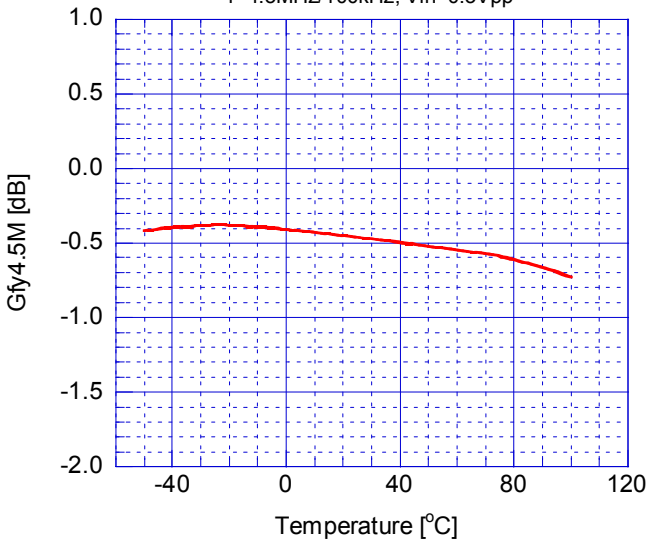

Temperature vs Gfy8M

f=8MHz/100kHz, Vin=0.3Vpp

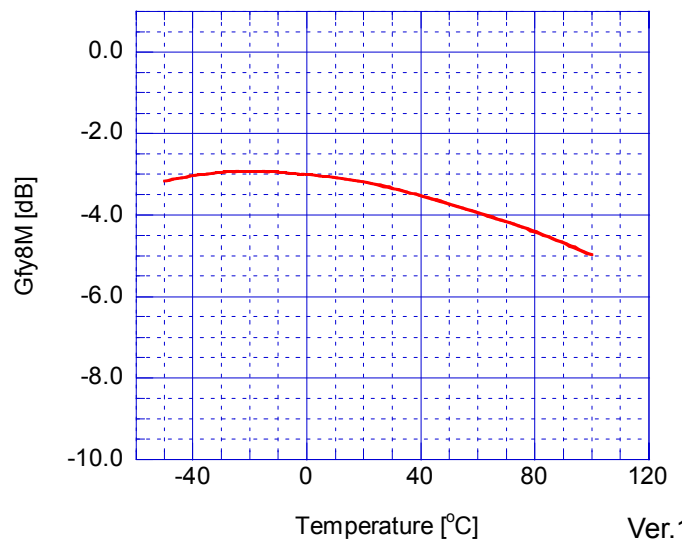

## Temperature vs Gfy<sub>23.5M</sub>

f=23.5MHz/100kHz, Vin=0.3Vpp

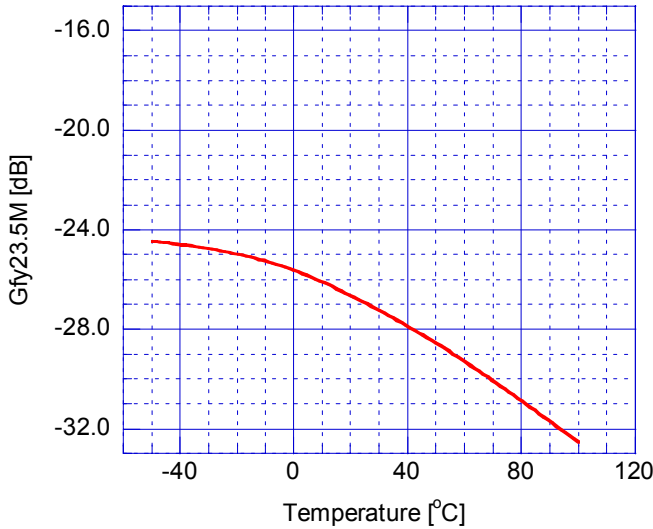

## Temperature vs DG

0.3Vpp, 10step video signal input

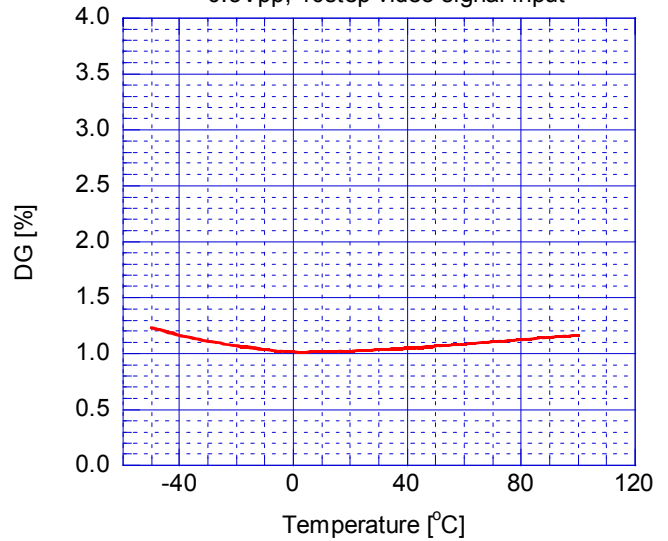

## Temperature vs DP

0.3Vpp, 10step video signal input

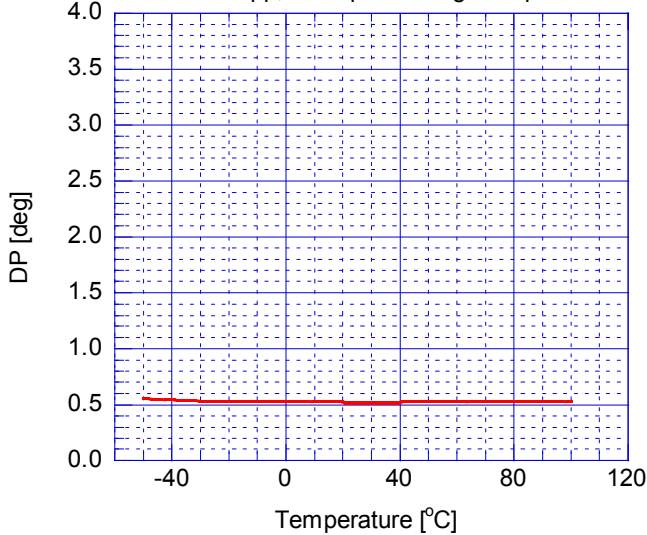

## Signal to Noise Ratio vs. Temperature

0.3Vpp, 100% white video signal input, 100kHz-6MHz

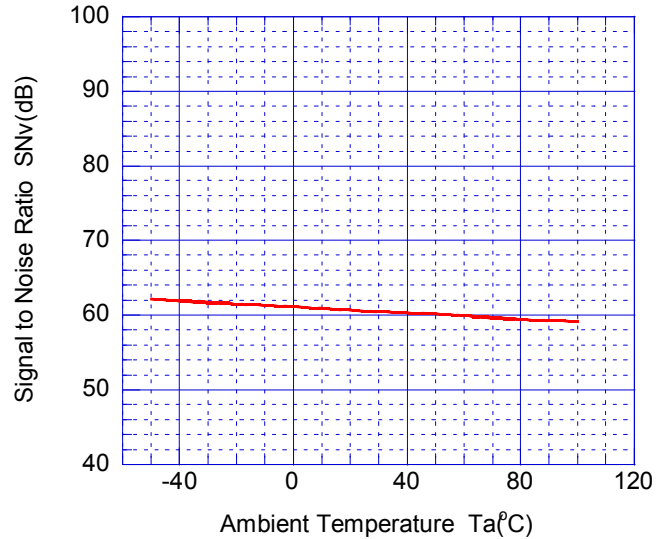

## Second Harmonic Distortion vs. Temperature

0.3Vpp, 3.58MHz sinewave signal input

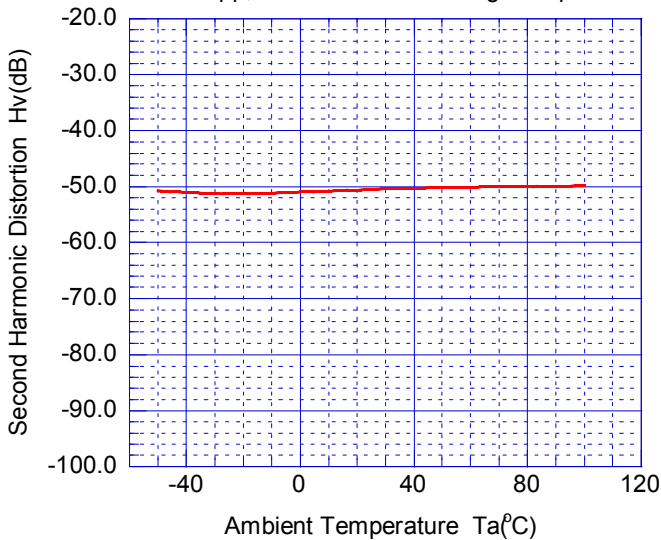

**[CAUTION]**  
The specifications on this databook are only given for information, without any guarantee as regards either mistakes or omissions. The application circuits in this databook are described only to show representative usages of the product and not intended for the guarantee or permission of any right including the industrial rights.