

SINGLE SUPPLY HI-SLEW RATE DUAL OPERATIONAL AMPLIFIER

■ GENERAL DESCRIPTION

The NJM2717 is single supply dual high slew rate operational amplifier. It is applicable to A/D converters, FAX, scanner which require the single supply operation and high slew rate.

■ PACKAGE OUTLINE



NJM2717D

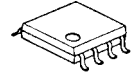

NJM2717M



NJM2717V



NJM2717RB1

■ FEATURES

- Single Supply
- Operating Voltage 2.7V to 12V
- High Slew Rate 40V/μs Typ. at V+=5V
- Operating Current 8mA typ. at V+=5V
- Output Voltage Range $V_{OH} \geq 4.5V$ Typ. at $V^+ = 5V, R_L = 4k\Omega$
 $V_{OL} \leq 0.05V$ Typ. at $V^+ = 5V, R_L = 4k\Omega$
- Bipolar Technology
- Package Outline DIP8, DMP8, SSOP8, TVSP8

■ PIN CONFIGURATION

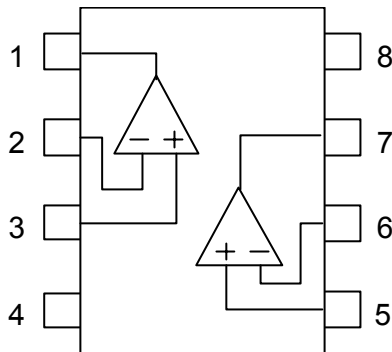

PIN FUNCTION

1. A OUTPUT
2. A -INPUT
3. A +INPUT
4. GND
5. B +INPUT
6. B -INPUT
7. B OUTPUT
8. V⁺

NJM2717D
 NJM2717M
 NJM2717V
 NJM2717RB1

NJM2717

■ ABSOLUTE MAXIMUM RATINGS

(Ta=25°C)

PARAMETER	SYMBOL	RATINGS	UNIT
Supply Voltage	V ⁺	15.0	V
Differential Input Voltage	V _{ID}	± 3	V
Input Common Mode Voltage Range	V _{ICM}	-0.3 to +15.0(Note 1)	V
Power Dissipation	P _D	(DIP8) 500 (DMP8) 300 (SSOP8) 250 (TVSP8) 320	mW
Output Sink Current	I _{SINK}	10	mA
Operating Temperature Range	T _{opr}	-40 to +85	°C
Storage Temperature Range	T _{stg}	-40 to +125	°C

(Note 1) For supply voltage less than 15V, the absolute maximum input voltage is equal to the supply voltage.

■ RECOMMENDED OPERATING CONDITION

(Ta=25°C)

PARAMETER	SYMBOL	TEST CONDITION	UNIT
Supply Voltage	V ⁺	2.7 to 12.0	V

■ ELECTRICAL CHARACTERISTICS

●DC CHARACTERISTICS

(V⁺=5V, Ta=25°C)

PARAMETER	SYMBOL	TEST CONDITION	MIN	TYP	MAX	UNIT
Operating Current	I _{CC}	R _L =∞, no signal	-	8.0	11.0	mA
Input Offset Voltage	V _{IO}	R _S =0Ω	-	1	11	mV
Input Bias Current	I _B		-	2	4.4	μA
Input Offset Current	I _{IO}		-	0.2	0.5	μA
Voltage Gain	A _V	R _L ≥ 10kΩ, V _O =1.5V to 3.5V	60	75	-	dB
Common Mode Rejection Ratio	CMR	0V ≤ V _{CM} ≤ 3.8V	45	80	-	dB
Supply Voltage Rejection Ratio	SVR	V ⁺ =4V to 8V	50	85	-	dB
Output Voltage 1	V _{OH1}	R _L =4kΩ to GND	4.3	4.5	-	V
	V _{OL1}		-	0.05	0.1	V
Output Voltage 2	V _{OH2}	R _L =4kΩ to 2.5V	4.5	4.7	-	V
	V _{OL2}		-	0.1	0.5	V
Output Source Current	I _{SOURCE}		1	2.5	-	mA
Output Sink Current	I _{SINK}		2.5	6	-	mA
Input Common Mode Voltage Range	V _{ICM}		0 to 3.8	-	5	V

●AC CHARACTERISTICS

(V⁺=5V, Ta=25°C)

PARAMETER	SYMBOL	TEST CONDITION	MIN	TYP	MAX	UNIT
Unity Gain Bandwidth	f _T		-	20	-	MHz

●TRANSIENT CHARACTERISTICS

(V⁺=5V, Ta=25°C)

PARAMETER	SYMBOL	TEST CONDITION	MIN	TYP	MAX	UNIT
Slew Rate	SR		-	40	-	V/μs

■ ELECTRICAL CHARACTERISTICS

●DC CHARACTERISTICS

($V^+=12V, T_a=25^\circ C$)

PARAMETER	SYMBOL	TEST CONDITION	MIN	TYP	MAX	UNIT
Operating Current	I_{CC}	$R_L = \infty$, no signal	-	10.0	14.5	mA
Input Offset Voltage	V_{IO}	$R_S = 0\Omega$	-	1	12	mV
Input Bias Current	I_B		-	2.1	4.4	μA
Input Offset Current	I_{IO}		-	0.2	1	μA
Voltage Gain	A_V	$R_L \geq 10k\Omega$, $V_O = 2V$ to $10V$	60	80	-	dB
Common Mode Rejection Ratio	CMR	$0V \leq V_{CM} \leq 10.8V$	45	80	-	dB
Supply Voltage Rejection Ratio	SVR	$V^+ = 8V$ to $12V$	50	85	-	dB
Output Voltage 1	V_{OH1} V_{OL1}	$R_L = 10k\Omega$ to GND	11.3 -	11.5 0.1	- 0.3	V V
Output Voltage 2	V_{OH2} V_{OL2}	$R_L = 10k\Omega$ to $6V$	11.5 -	11.7 0.1	- 0.5	V V
Output Source Current	I_{SOURCE}		1	3	-	mA
Output Sink Current	I_{SINK}		2.5	8	-	mA
Input Common Mode Voltage Range	V_{ICM}		0 to 10.8	-	-	V

●AC CHARACTERISTICS

($V^+=12V, T_a=25^\circ C$)

PARAMETER	SYMBOL	TEST CONDITION	MIN	TYP	MAX	UNIT
Unity Gain Bandwidth	f_T		-	21	-	MHz

●TRANSIENT CHARACTERISTICS

($V^+=12V, T_a=25^\circ C$)

PARAMETER	SYMBOL	TEST CONDITION	MIN	TYP	MAX	UNIT
Slew Rate	SR		-	45	-	V/ μs

NJM2717

■ ELECTRICAL CHARACTERISTICS

●DC CHARACTERISTICS

($V^+=2.7V, T_a=25^\circ C$)

PARAMETER	SYMBOL	TEST CONDITION	MIN	TYP	MAX	UNIT
Operating Current	I_{CC}	$R_L = \infty$, no signal	-	6	8.5	mA
Input Offset Voltage	V_{IO}	$R_S = 0\Omega$	-	1	10	mV
Input Bias Current	I_B		-	1.7	4.4	μA
Input Offset Current	I_{IO}		-	0.2	0.5	μA
Voltage Gain	A_V	$R_L \geq 10k\Omega$, $V_O = 0.85V$ to $1.85V$	60	73	-	dB
Common Mode Rejection Ratio	CMR	$0V \leq V_{CM} \leq 1.5V$	45	80	-	dB
Supply Voltage Rejection Ratio	SVR	$V^+ = 2.7V$ to $4V$	50	75	-	dB
Output Voltage 1	V_{OH1} V_{OL1}	$R_L = 4k\Omega$ to GND	2.5 -	2.6 0.05	- 0.1	V V
Output Voltage 2	V_{OH2} V_{OL2}	$R_L = 4k\Omega$ to $1.35V$	2.6 -	2.65 0.1	- 0.2	V V
Output Source Current	I_{SOURCE}		1	2.5	-	mA
Output Sink Current	I_{SINK}		2.5	5	-	mA
Input Common Mode Voltage Range	V_{ICM}		0 to 1.5	-	-	V

●AC CHARACTERISTICS

($V^+=2.7V, T_a=25^\circ C$)

PARAMETER	SYMBOL	TEST CONDITION	MIN	TYP	MAX	UNIT
Unity Gain Bandwidth	f_T		-	19	-	MHz

●TRANSIENT CHARACTERISTICS

($V^+=2.7V, T_a=25^\circ C$)

PARAMETER	SYMBOL	TEST CONDITION	MIN	TYP	MAX	UNIT
Slew Rate	SR		-	30	-	V/ μs

■ Typical Characteristics

Operating Current vs. Supply Voltage
(Ambient Temperature)

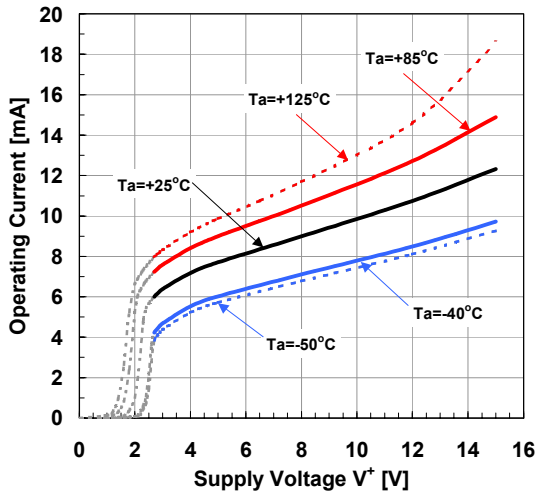

Operating Current vs. Ambient temperature

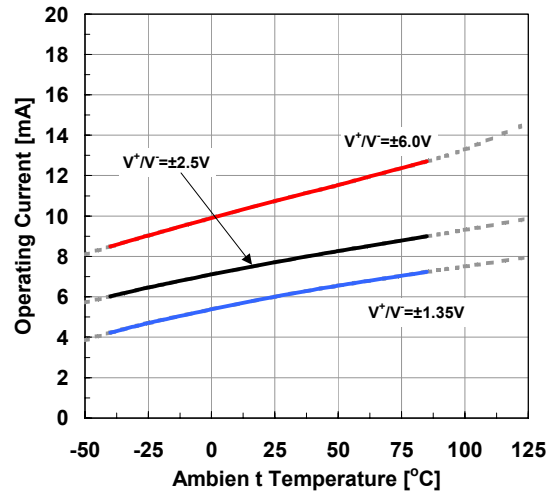

Input Offset Voltage vs. Supply Voltage
(Ambient Temperature)

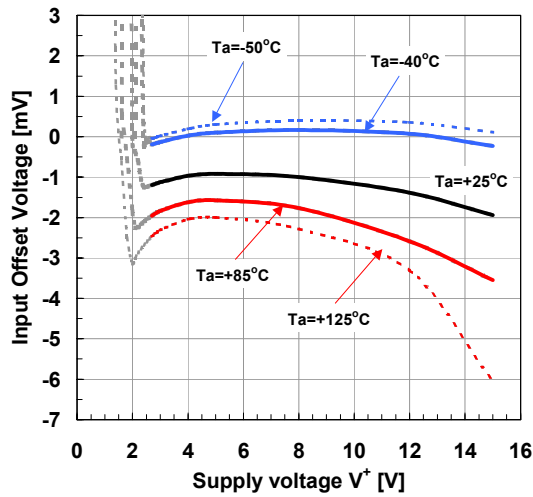

Input Offset Voltage vs. Ambient Temperature

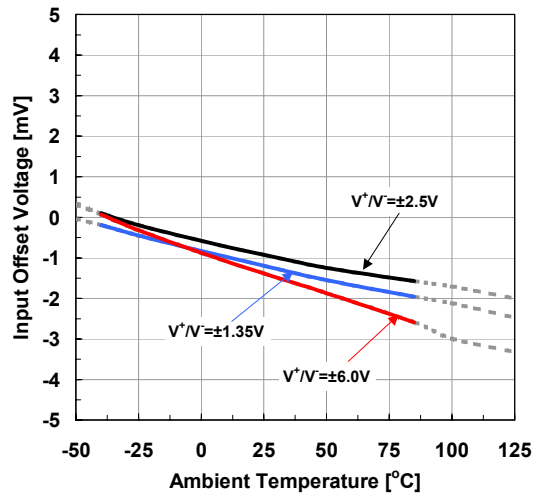

Typical Characteristics

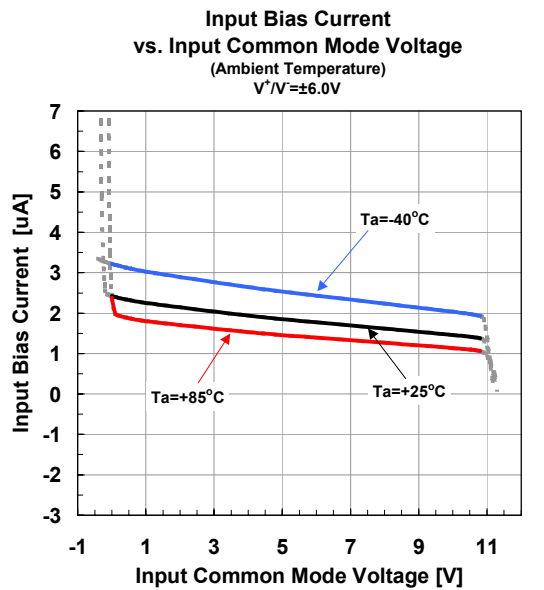
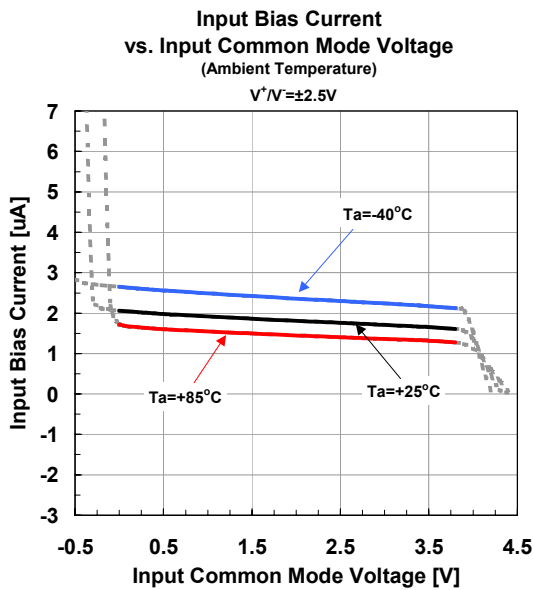
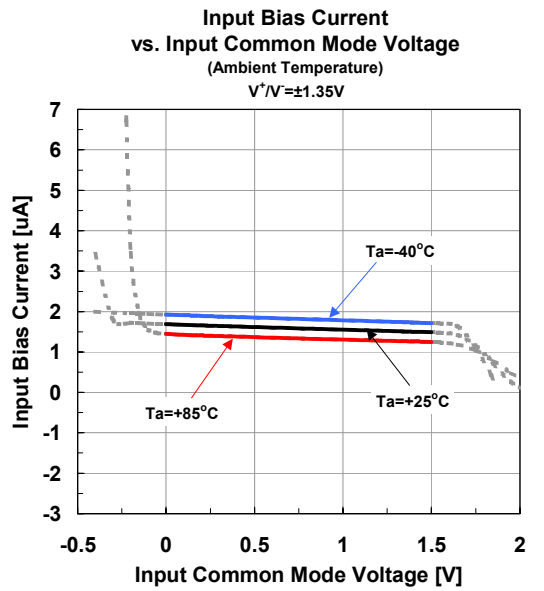
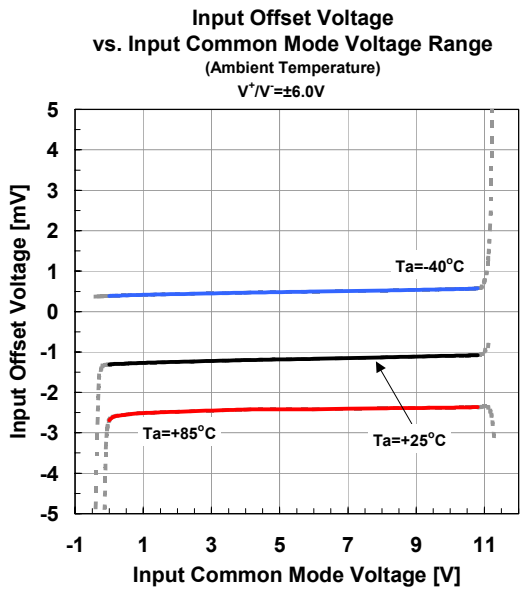
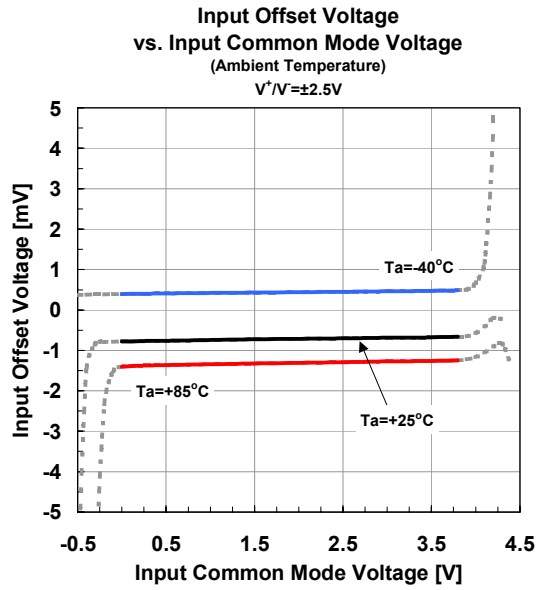
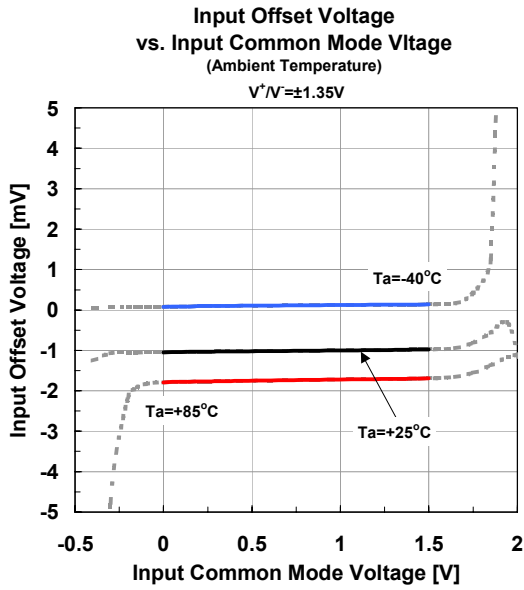

■ Typical Characteristics

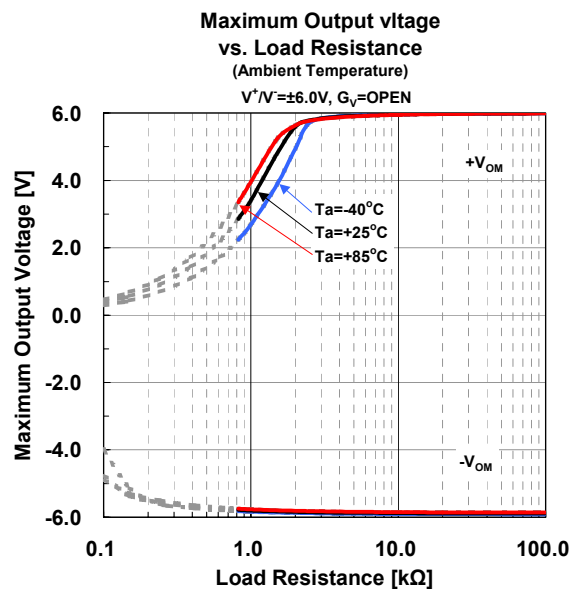
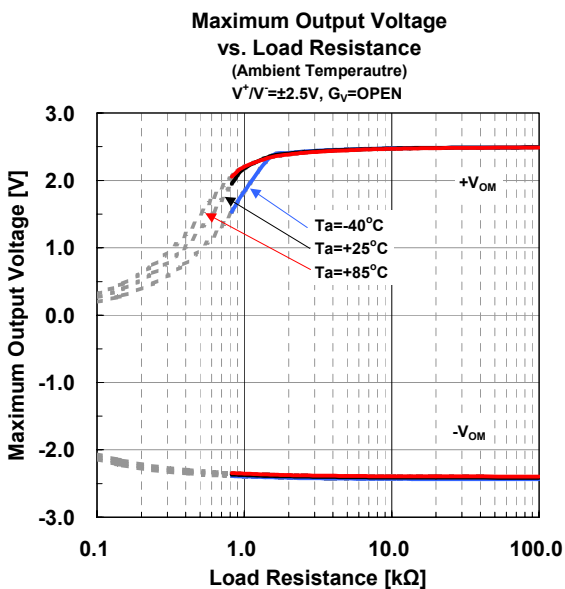
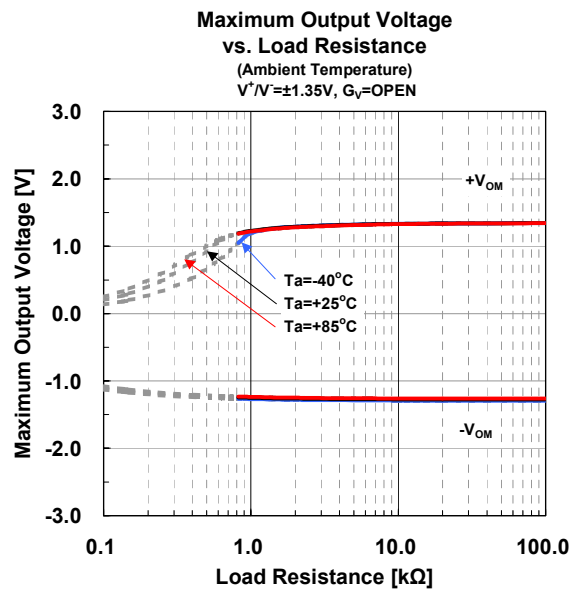
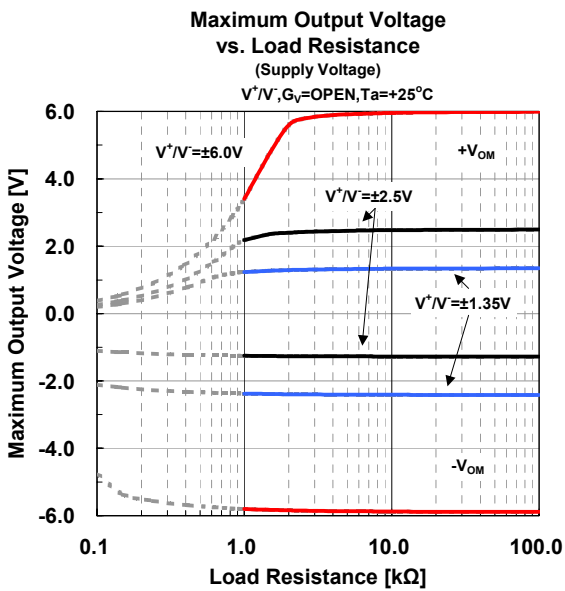
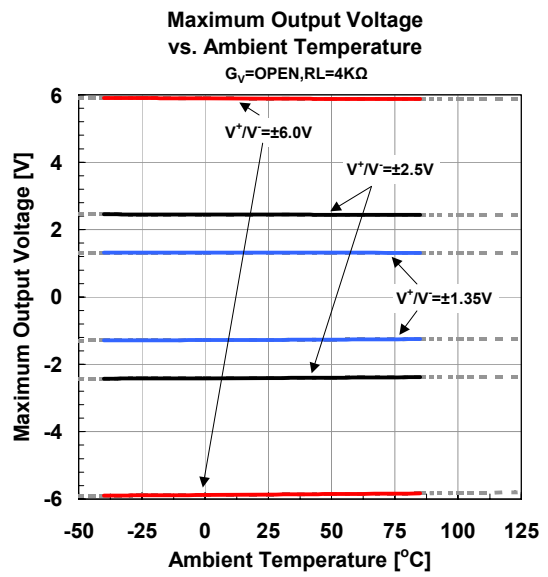
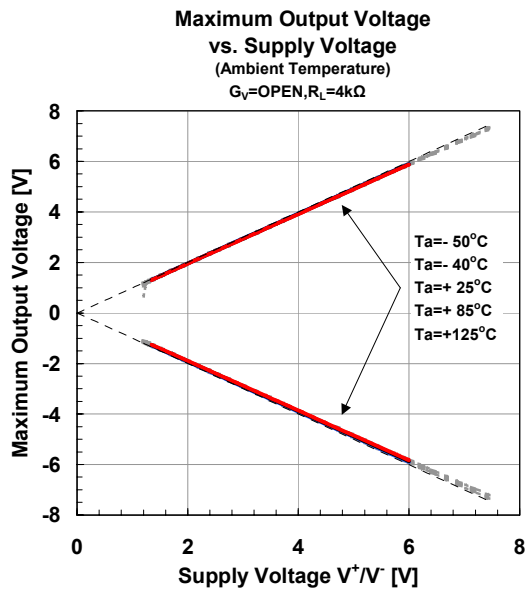

■ Typical Characteristics

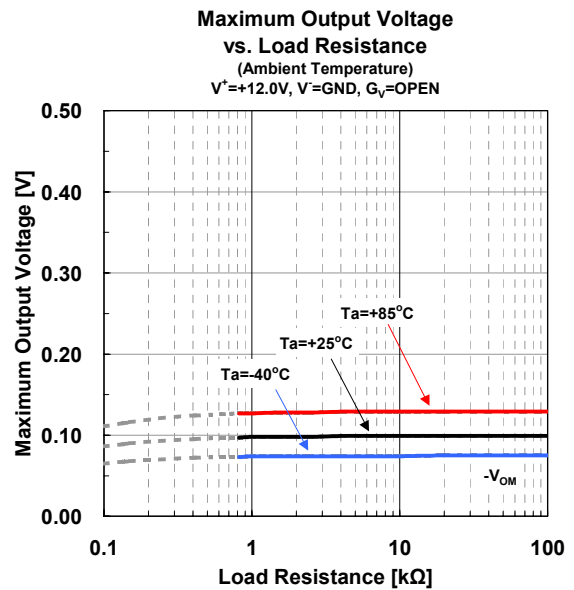
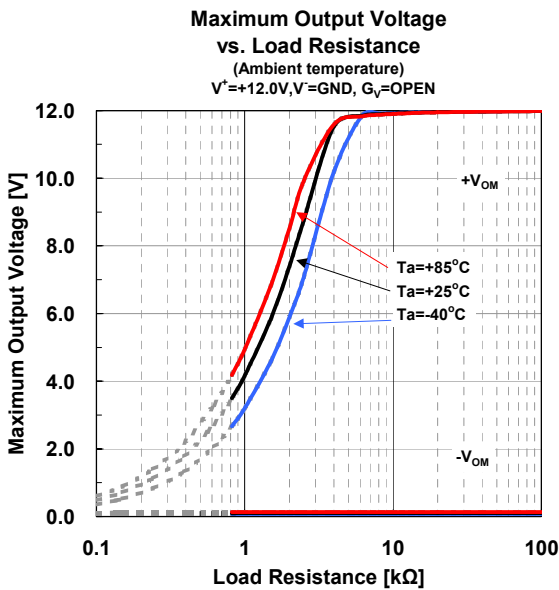
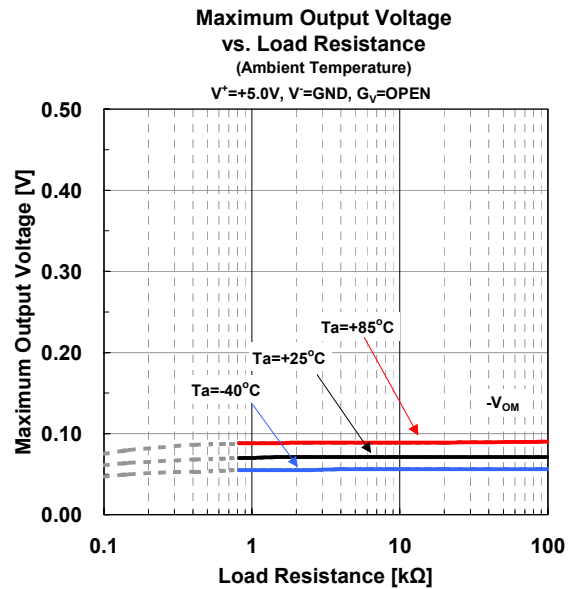
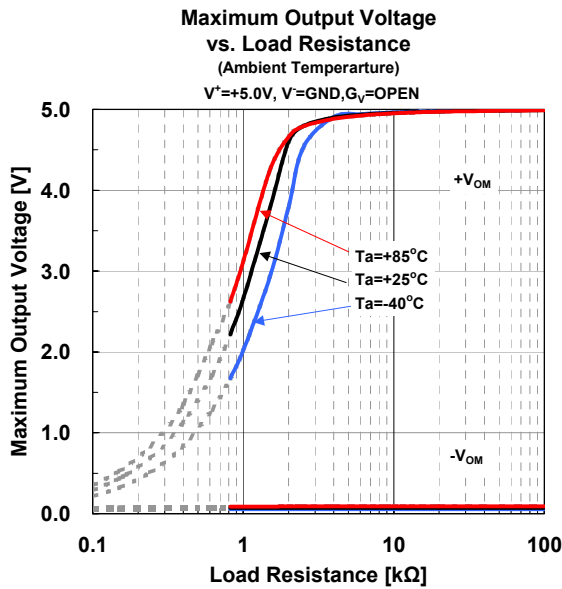
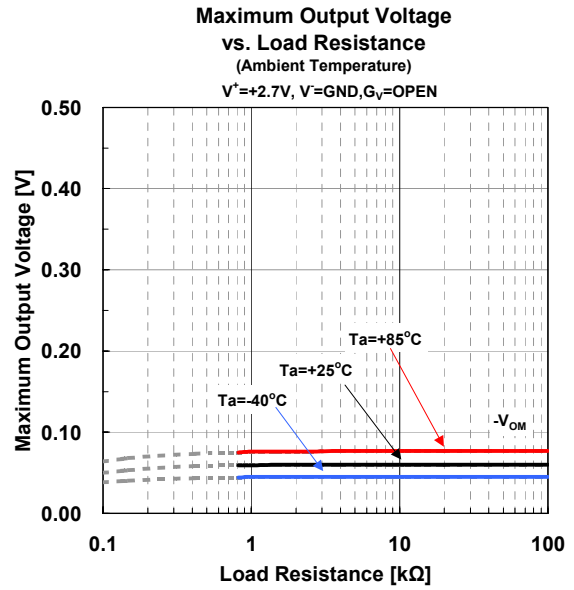
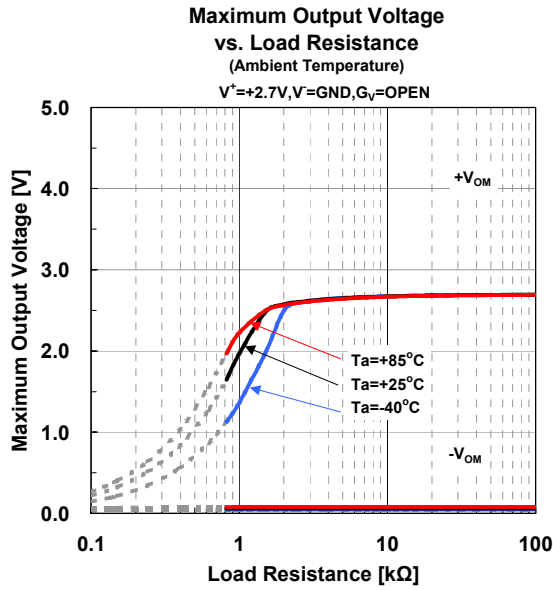

■ Typical Characteristics

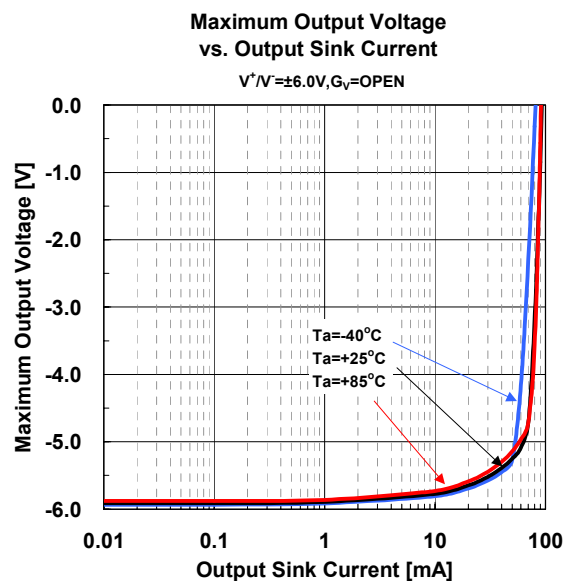
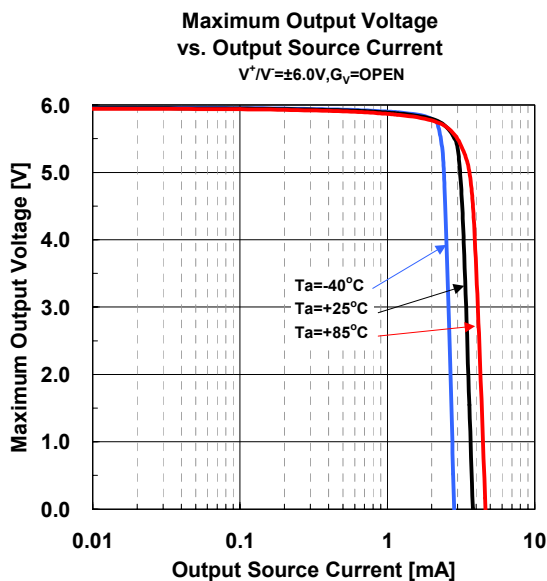
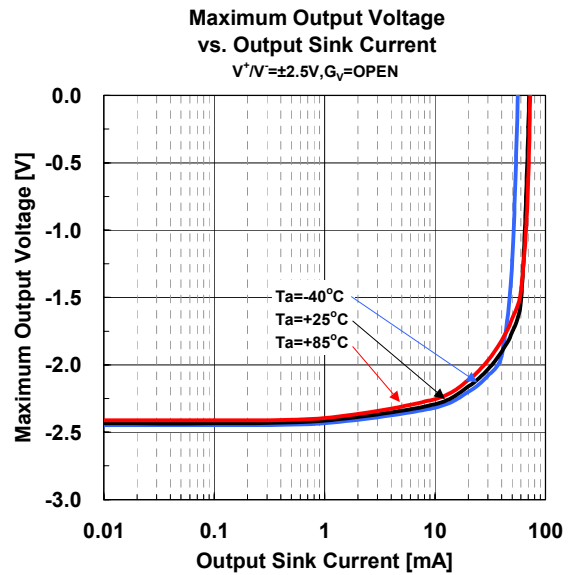
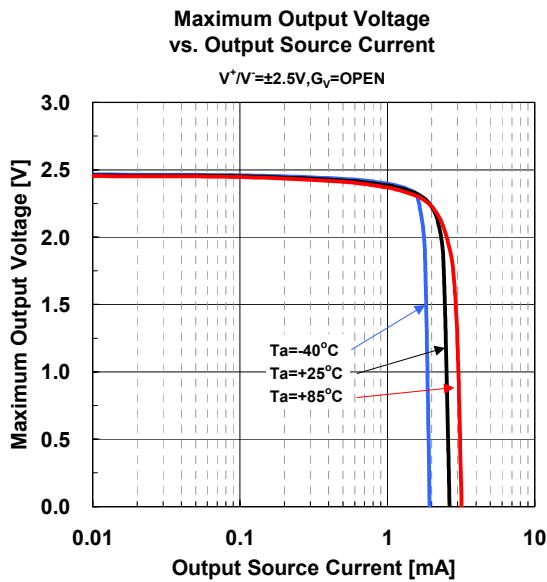
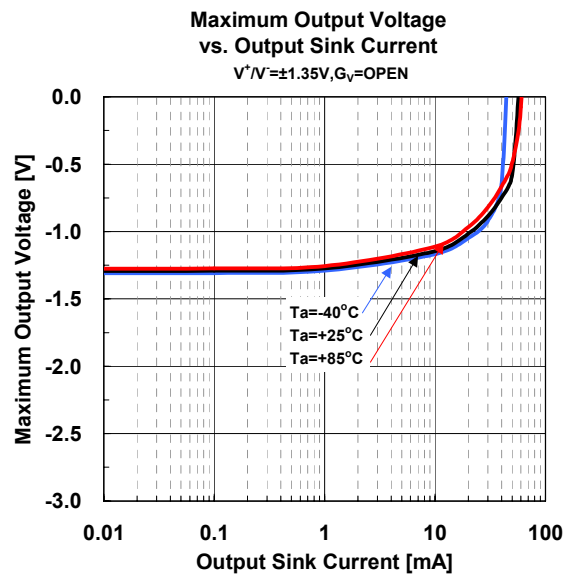
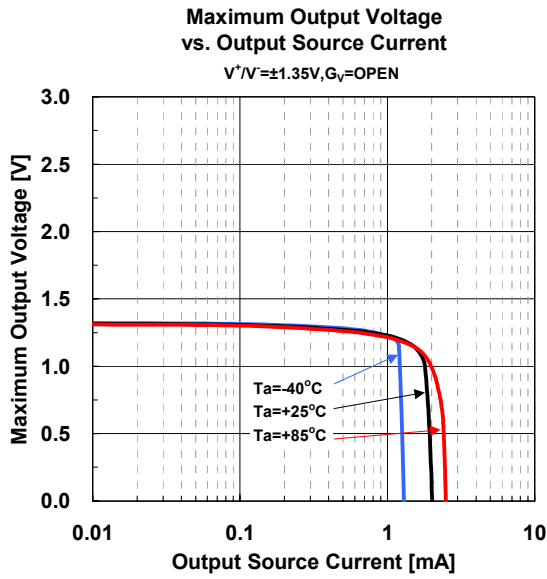

■ Typical Characteristics

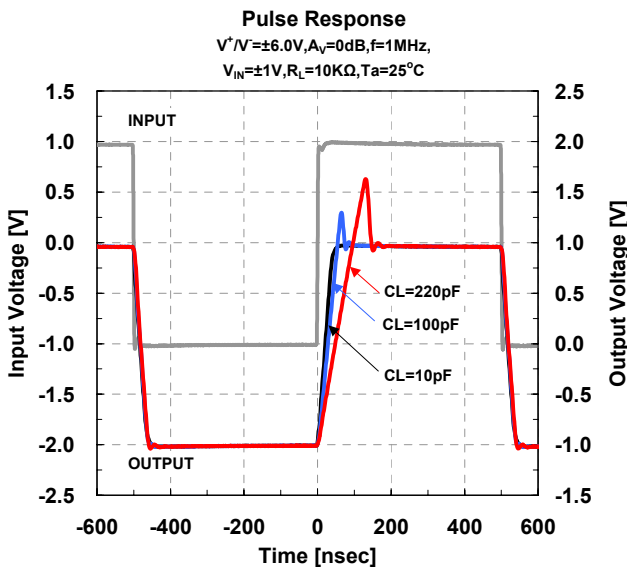
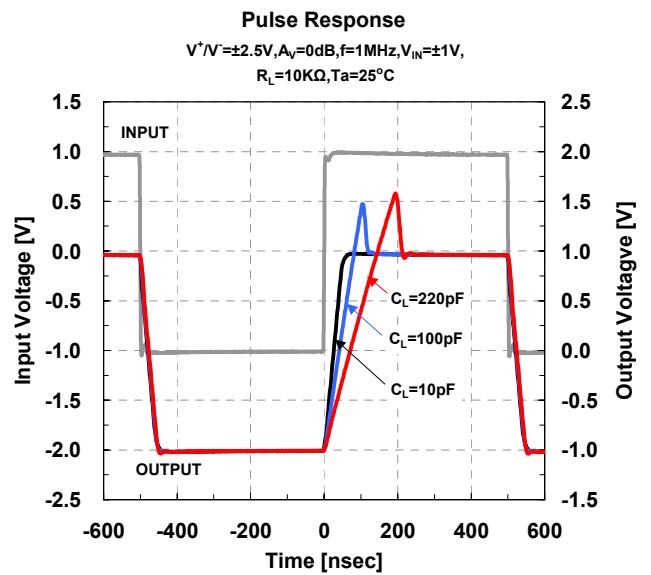
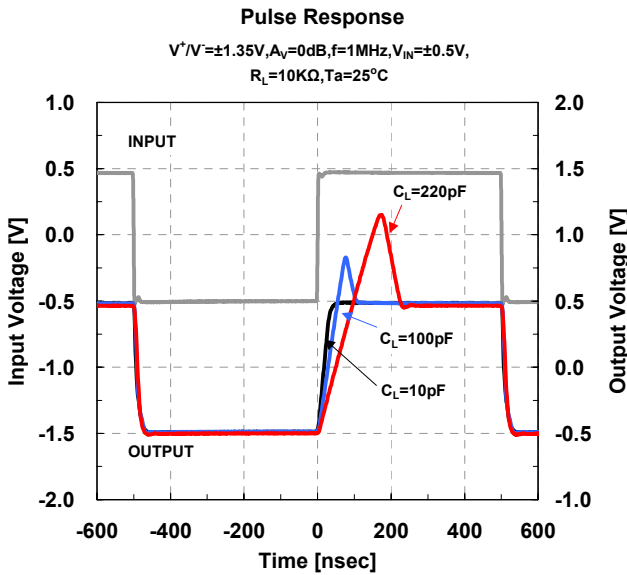
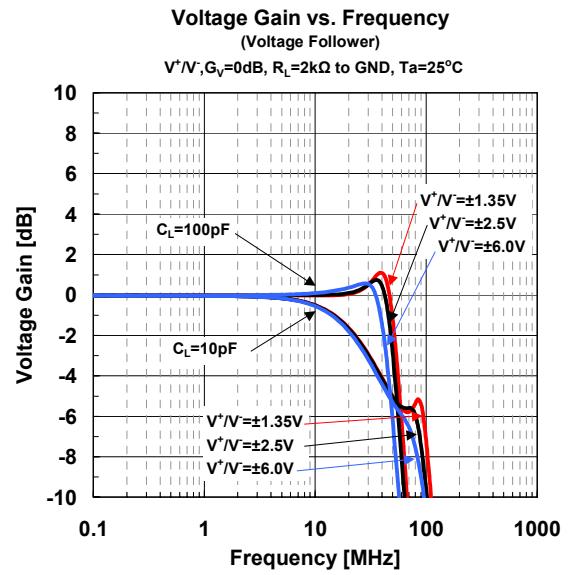
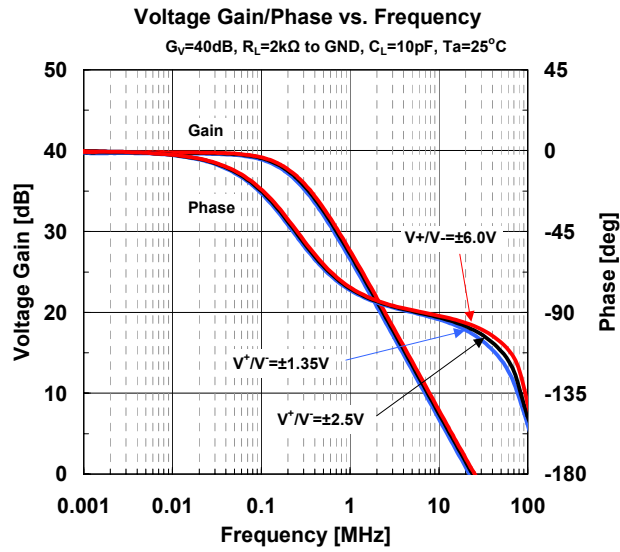

[CAUTION]
 The specifications on this data book are only given for information, without any guarantee as regards either mistakes or omissions. The application circuits in this data book are described only to show representative usages of the product and not intended for the guarantee or permission of any right including the industrial rights.