

Single Ultra-High speed and Wide Band Operational Amplifier

■ GENERAL DESCRIPTION

The **NJM2720** is single and ultra-high speed and wide band operational amplifier.

The NJM2720 is 250V/ μ s slew rate and 150ohm load drive is possible, at supply voltage of ± 2.5 V.

The NJM2720 is suitable for video signal processing, video line driver, video buffer, pulse amplifiers, ADC input buffer, measuring instrument, and digital communication.

■ PACKAGE OUTLINE



NJM2720E

■ FEATURES

- Operating Voltage : ± 2.5 V to ± 5.0 V
- Slew Rate : 250V/ μ s Typ. (at $V^+V^- = \pm 2.5$ V, $R_L = 150\Omega$)
- Unity-Gain : 120MHz Typ.
- Output Voltage : $V_{OH} = +1.4$ V Typ. (at $V^+V^- = \pm 2.5$ V, $R_L = 150\Omega$)
: $V_{OL} = -1.4$ V Typ. (at $V^+V^- = \pm 2.5$ V, $R_L = 150\Omega$)
- Offset Voltage : 1.5mV Typ.
- Operating Current : 9.0 mA Typ.
- Adequate phase margin : $\Phi_M = 60$ deg. Typ. (at $R_L = 2k\Omega$, voltage follower)
- Bipolar Technology
- Package Outline : EMP8

■ PIN CONFIGURATION

(Top View)

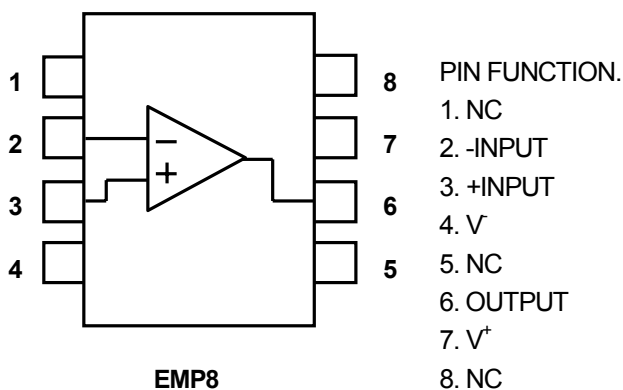

NJM2720

■ ABSOLUTE MAXIMUM RATINGS

(Ta=25°C)

PARAMETER	SYMBOL	RATINGS	UNIT
Supply Voltage	V ⁺	11.0	V
Power Dissipation	P _D	EMP8 : 730 (Note1)	mW
Differential Input Voltage Range	V _{ID}	±3.0	V
Common Mode Input Voltage Range	V _{ICM}	11.0	V
Operating Temperature Range	T _{opr}	-40 to +85	°C
Storage Temperature Range	T _{stg}	-40 to +125	°C

(Note 1) On the PCB " EIA/JEDEC (76.2x11.43x1.6mm, four layers, FR-4) "

■ RECOMMENDED OPERATING CONDITION

(Ta=25°C)

PARAMETER	SYMBOL	RATING	UNIT
Supply Voltage	V ⁺ /V ⁻	±2.5 to ±5.0	V

■ ELECTRICAL CHARACTERISTICS

●DC CHARACTERISTICS

(V⁺/V⁻=±2.5V, Ta=25°C)

PARAMETER	SYMBOL	TEST CONDITION	MIN.	TYP.	MAX.	UNIT
Operating Current	I _{CC}	No Signal	-	9.0	15.0	mA
Input Offset Voltage	V _{IO}		-	1.5	16.0	mV
Input Bias Current	I _B		-	7.5	30.0	μA
Input Offset Current	I _{IO}		-	100	900	nA
Large Signal Voltage Gain	A _V	R _L =2kΩ	50	60	-	dB
Input Common Mode Voltage Range	V _{ICM}		+1.7 -1.2	+2.0 -1.5	- -	V V
Common Mode Rejection Ratio	CMR	-1.2V≤V _{ICM} ≤+1.7V	60	80	-	dB
Supply Voltage Rejection Ratio	SVR	±2.5V≤V ⁺ /V ⁻ ≤±5.0V	55	65	-	dB
Maximum Output Voltage Swing	V _{OM}	R _L =150Ω	±1.2	±1.4	-	V

●AC CHARACTERISTICS

(V⁺/V⁻=±2.5V, Ta=25°C)

PARAMETER	SYMBOL	TEST CONDITION	MIN.	TYP.	MAX.	UNIT
Unity Gain Frequency	f _T	A _V =40dB, R _F =1.98kΩ R _G =20Ω, R _L =∞, C _L =5pF	-	120	-	MHz
Phase Margin	Φ _M	A _V =40dB, R _F =1.98kΩ R _G =20Ω, R _L =∞, C _L =5pF	-	60.0	-	Deg

●AC CHARACTERISTICS

(V⁺/V⁻=±2.5V, Ta=25°C)

PARAMETER	SYMBOL	TEST CONDITION	MIN.	TYP.	MAX.	UNIT
Slew Rate	SR	A _V =0dB, R _F =0Ω, R _G =∞ R _L =150Ω, C _L =5pF V _{IN} =2V _{PP}	-	250	-	V/μs

■ TYPICAL CHARACTERISTICS

Operating Current vs. Operating Voltage

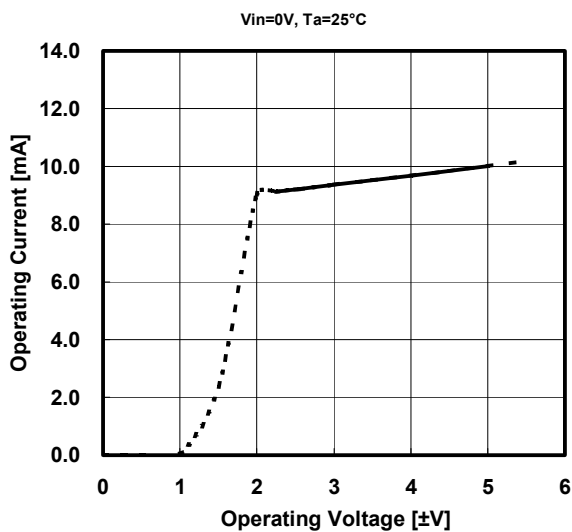

Operating Current vs. Ambient Temperature

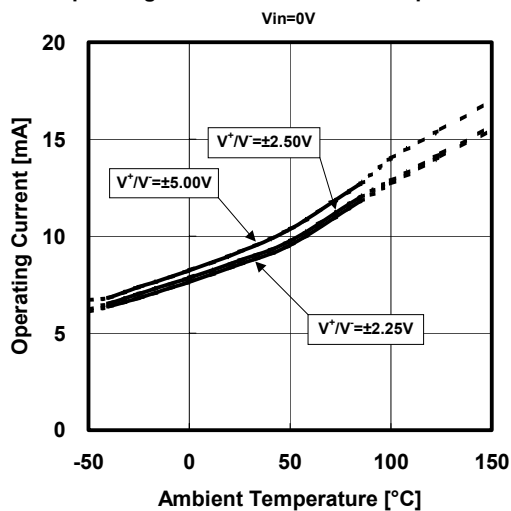

Input Offset Voltage vs. Ambient Temperature

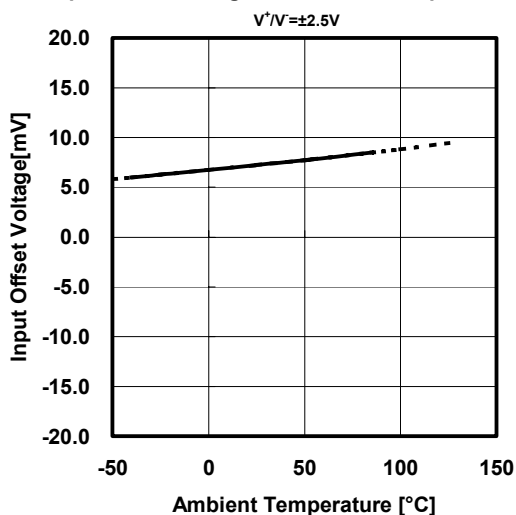

Input Offset Current vs. Ambient Temperature

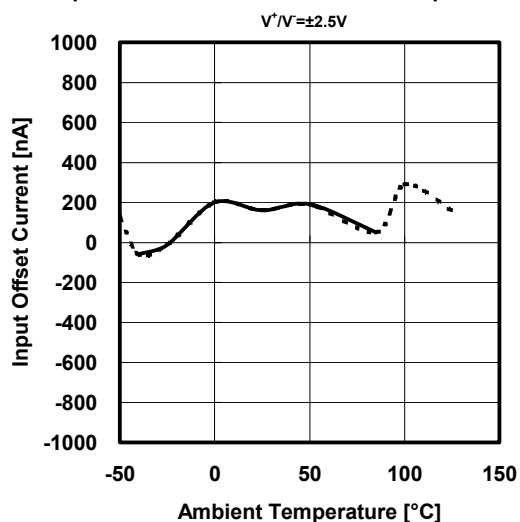

Input Bias Current vs. Ambient Temperature

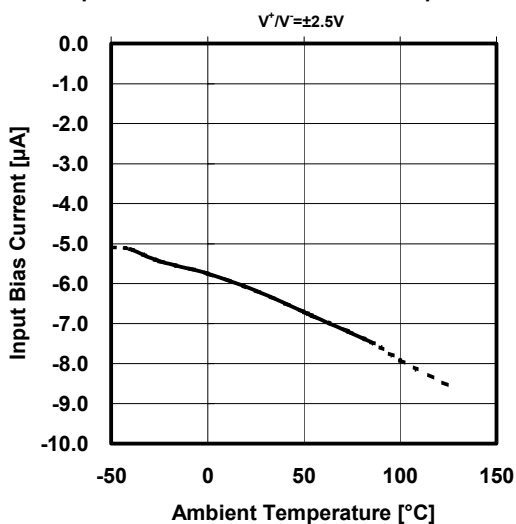

■ TYPICAL CHARACTERISTICS

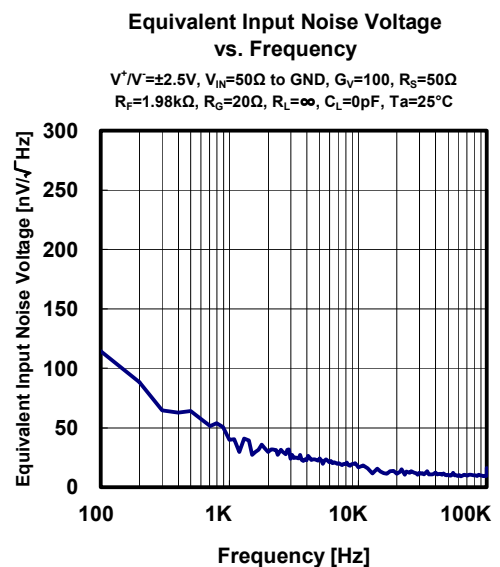
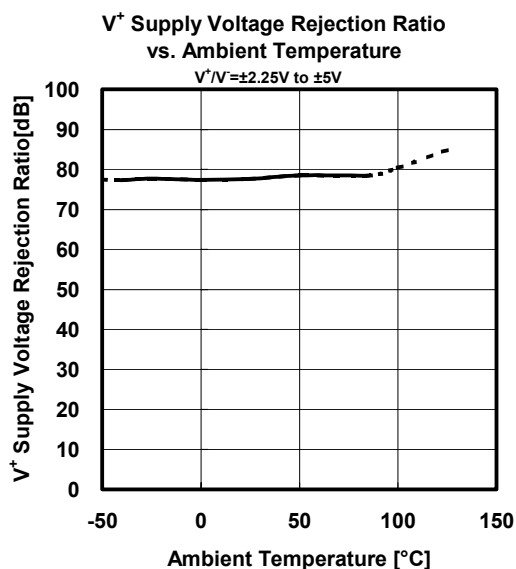
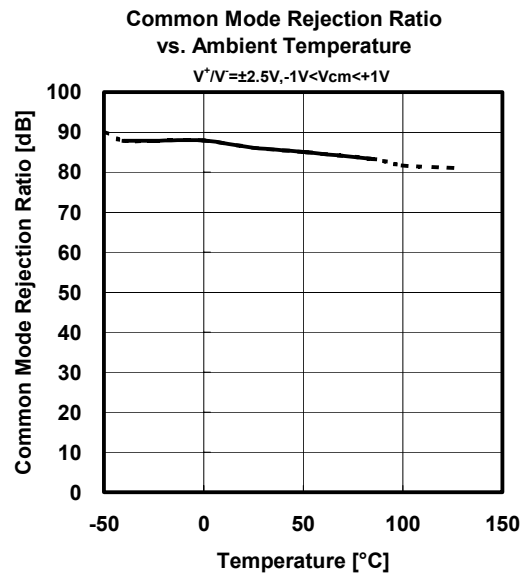
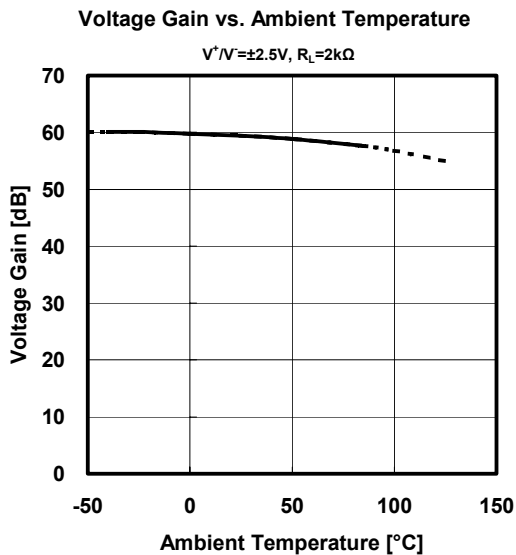
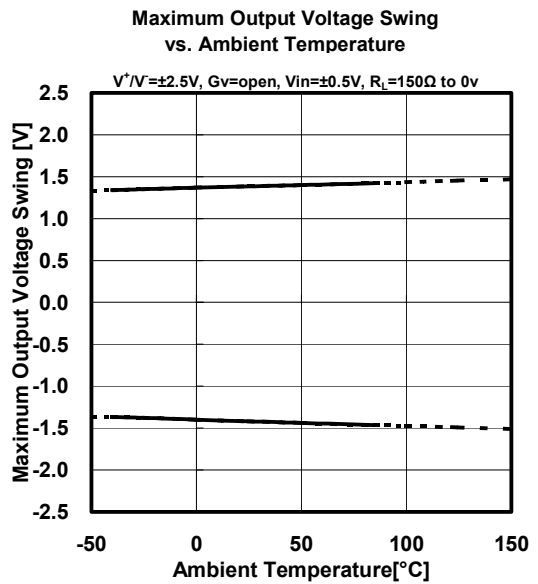
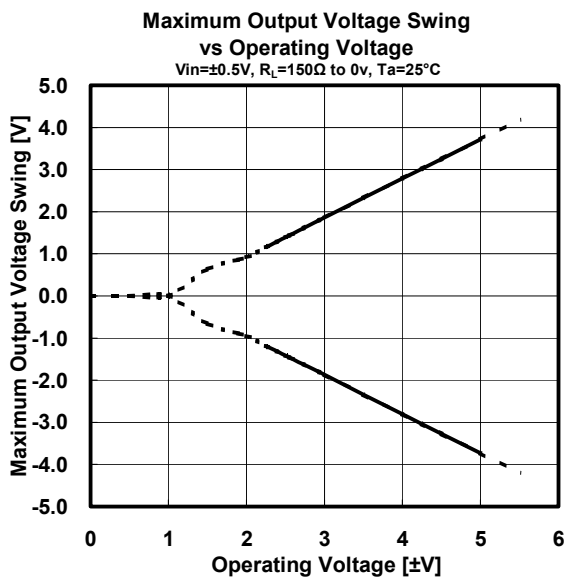

■ TYPICAL CHARACTERISTICS

Pulse Response (with Capacitive load)

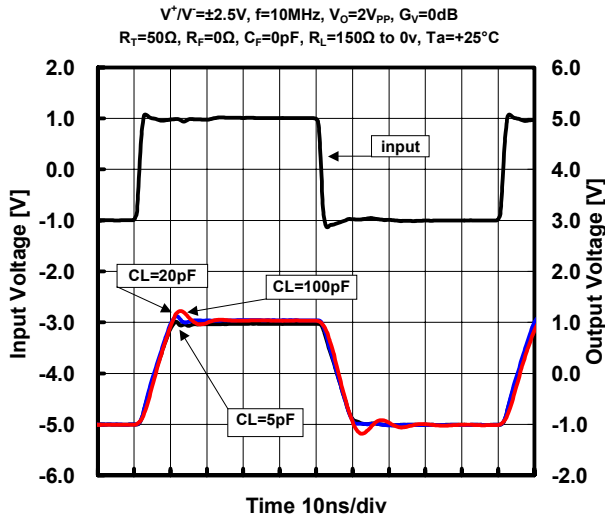

Pulse Response (correlation with T_a)

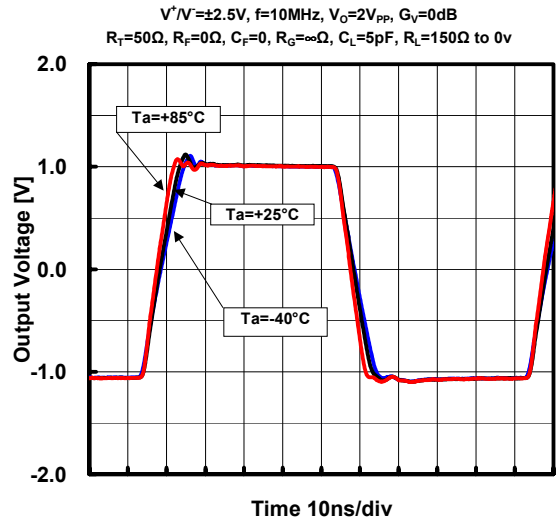

Voltage Gain vs. Frequency (with Capacitive Load)

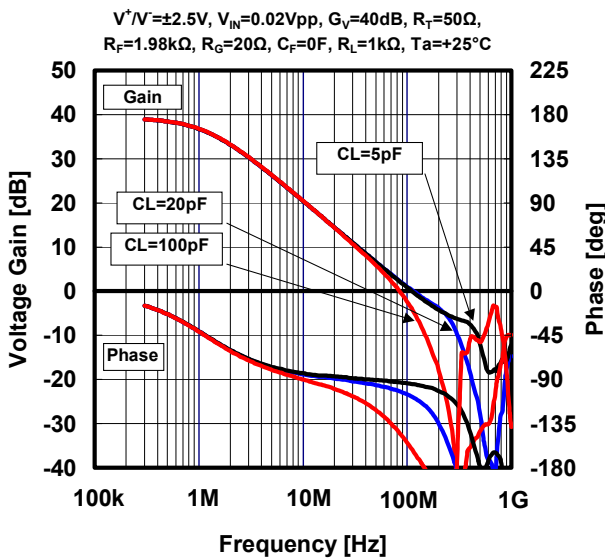

Voltage Gain vs. Frequency (correlation with T_a)

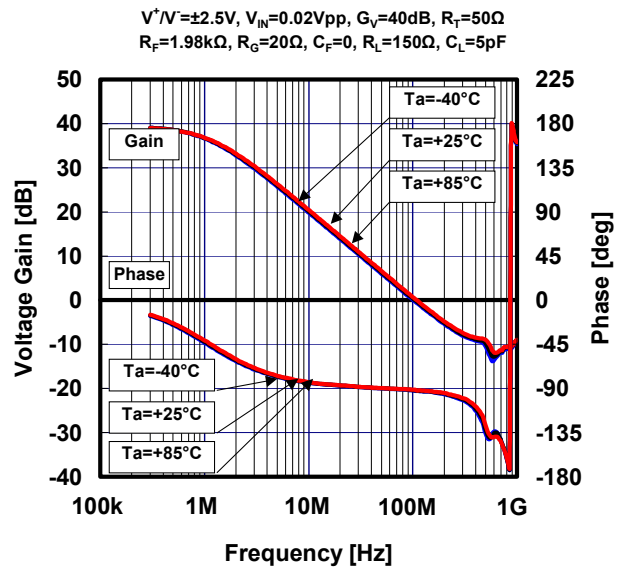

Voltage Gain vs. Frequency (with Capacitive Load)

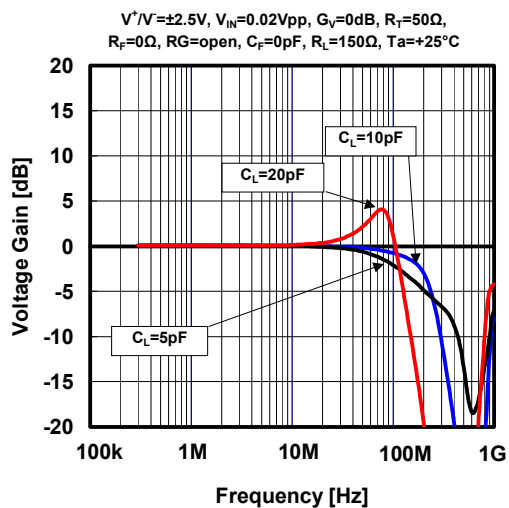

Voltage Gain vs. Frequency (correlation with T_a)

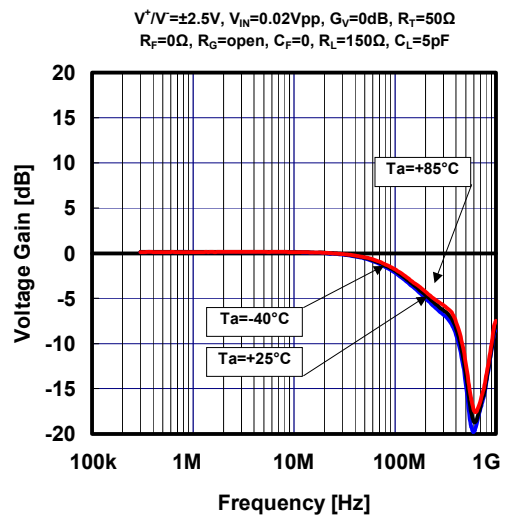

[CAUTION]
The specifications on this data book are only given for information, without any guarantee as regards either mistakes or omissions. The application circuits in this data book are described only to show representative usages of the product and not intended for the guarantee or permission of any right including the industrial rights.