

## Low Offset, Low Drift Dual JFET Input Operational Amplifier

### ■ GENERAL DESCRIPTION

The **NJM2749/2749A** is a Precision dual JFET input operational amplifier which includes low input offset voltage: 0.8mV (typ) / 2.5mV (max) and 6 $\mu$ V/°C typical offset drift.

The **NJM2749A** is guaranteed 20 $\mu$ V/°C maximum offset drift to perform a 100% tested.

The NJM2749/2749A have the following features: low bias current of 50pA (typ), high slew rate of 13V/ $\mu$ s (typ).

These features are suitable for signal processing amplifiers of instrumentation, measurement and industrial applications such as sensor amplifier, current sensing and sample-and-hold circuit.

### ■ FEATURES

● Input Offset Voltage Drift

NJM2749:  $\Delta V_{IO}/\Delta T = 6\mu\text{V}/^\circ\text{C}$  typ.

NJM2749A:  $\Delta V_{IO}/\Delta T = 20\mu\text{V}/^\circ\text{C}$  max.

● Input Offset Voltage

2.5mV max. @Ta=25°C ~ 85°C

3.5mV max. @Ta= -40°C

● Input Bias Current

$I_B = 50\text{pA}$  typ. 200pA max. @Ta=25°C

● Slew Rate

SR=13V/ $\mu$ s typ. @Ta=25°C

● Operating Voltage

Vopr=  $\pm 6.0\text{V} \sim \pm 16\text{V}$

● Voltage Gain

Av=100dB typ.

● Bipolar Technology

● Dual channel

● Package Outline

NJM2749D, NJM2749AD : DIP8

NJM2749M, NJM2749AM : DMP8

NJM2749E, NJM2749AE : SOP8 JEDEC 150mil

### ■ PACKAGE OUTLINE

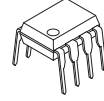

**NJM2749D / 2749AD**  
(DIP8)



**NJM2749M / 2749AM**  
(DMP8)



**NJM2749E / 2749AE**  
(SOP8)

### ■ PIN CONFIGURATION

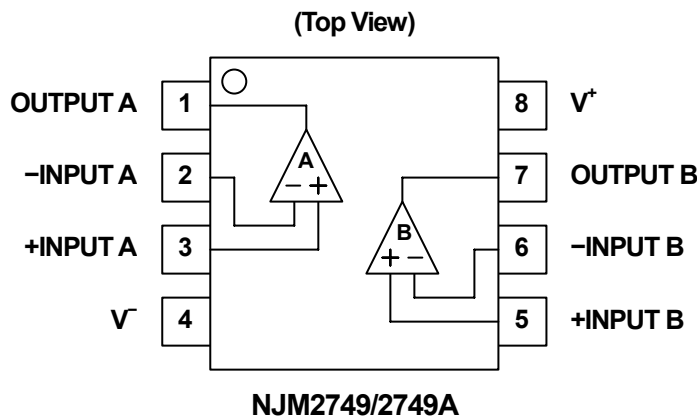

# NJM2749/2749A

## ■ABSOLUTE MAXIMUM RATING (Ta=25°C unless otherwise specified)

PARAMETER	SYMBOL	RATING	UNIT
Supply Voltage	$V^+V^-$	±18	V
Common Mode Input Voltage	$V_{ICM}$	±15 (Note1)	V
Differential Input Voltage	$V_{ID}$	±30	V
Power Dissipation	$P_D$	500 [DIP8], 300 [DMP8,SOP8]	mW
		430 [DMP8], 640 [SOP8] (Note2)	mW
		580 [DMP8], 1000 [SOP8] (Note3)	mW
Operating Temperature Range	$T_{opr}$	-40 ~ +85	°C
Storage Temperature Range	$T_{stg}$	-50 ~ +125	°C

(Note1) For supply voltage less than ±18V, the maximum input voltage is equal to the supply voltage.

(Note2) Mounted on the EIA/JEDEC standard board (76.2×114.3×1.6mm, two layer, FR-4).

(Note3) Mounted on the EIA/JEDEC standard board (76.2×114.3×1.6mm, four layer, FR-4).

## ■RECOMMENDED OPERATING VOLTAGE (Ta=25°C)

PARAMETER	SYMBOL	RATING	MIN.	TYP.	MAX.	UNIT
Supply Voltage	$V^+V^-$		±6	-	±16	V

## ■ELECTRONIC CHARACTERISTICS

### ●DC CHARACTERISTICS ( $V^+V^-$ =±15V, Ta=-40 to +85°C (Note4) unless otherwise specified)

PARAMETER	SYMBOL	CONDITION	MIN.	TYP.	MAX.	UNIT
Input Offset Voltage Drift	$\Delta V_{IO}/\Delta T$	NJM2749A (Note5, 6)	-	6	20	$\mu V/^\circ C$
		NJM2749	-	6	-	
Input Offset Voltage1	$V_{IO1}$	$R_S=50\Omega$ , Ta=+85°C (Note6, 7)	-	0.7	2.5	mV
Input Offset Voltage2	$V_{IO2}$	$R_S=50\Omega$ , Ta=+25°C (Note6, 7)	-	0.8	2.5	mV
Input Offset Voltage3	$V_{IO3}$	$R_S=50\Omega$ , Ta=-40°C (Note6, 7)	-	1.0	3.5	mV
Common Mode Rejection Ratio	CMR	$V_{ICM}=\pm 10V$ (Note8)	76	92	-	dB
Supply Voltage Rejection Ratio	SVR	$V^+V^-$ =±6V ~ ±16V (Note7, 9)	80	100	-	dB
Input Common Mode Voltage Range 1	$V_{ICM1}$	CMR≥76dB (Note10)	+10	+14.5	-	V
Input Common Mode Voltage Range 2	$V_{ICM2}$	CMR≥76dB (Note10)	-	-11	-10	V
Input Bias Current 1	$I_{B1}$	Ta=+25°C (Note7)	-	50	200	pA
Input Bias Current 2	$I_{B2}$	Ta=+85°C (Note7)	-	-	4	nA
Input Offset Current 1	$I_{IO1}$	Ta=+25°C (Note7)	-	25	100	pA
Input Offset Current 2	$I_{IO2}$	Ta=+85°C (Note7)	-	-	2	nA
Voltage Gain 1	$A_{V1}$	$R_L=2k\Omega$ , $V_o=\pm 10V$ , Ta=+25°C	88	100	-	dB
Voltage Gain 2	$A_{V2}$	$R_L=2k\Omega$ , $V_o=\pm 10V$	82	100	-	dB
Maximum Output Voltage 1	$V_{OM1}$	$R_L=10k\Omega$	±12	±13.5	-	V
Maximum Output Voltage 2	$V_{OM2}$	$R_L=2k\Omega$	±10	±11.5	-	V
Supply Current	$I_{CC}$	Voltage Follower, $R_L=\infty$ (Note7)	-	3.8	5.6	mA

(Note4) These devices are measured under three temperature conditions of  $T_a = -40^\circ\text{C}$ ,  $+25^\circ\text{C}$ ,  $+85^\circ\text{C}$ .

(Note5) Temperature coefficient is calculated by specified change in offset voltage. (Changes  $T_a = +25^\circ\text{C}$  to  $-40^\circ\text{C}$  and  $T_a = +25^\circ\text{C}$  to  $+85^\circ\text{C}$ )

NJM2749A is guaranteed maximum specification because these are 100% tested to operating temperature range.

NJM2749 is guaranteed only typical specification.

(Note6) Written by the absolute rate.

(Note7) Measured at  $V_{ICM} = 0\text{V}$

(Note8) CMR is calculated by specified change in offset voltage. ( $V_{ICM} = 0\text{V}$  to  $+10\text{V}$  and  $V_{ICM} = 0\text{V}$  to  $-10\text{V}$ )

(Note9) SVR is calculated by specified change in offset voltage. ( $V^+V^- = \pm 6\text{V}$  to  $\pm 16\text{V}$ )

(Note10)  $V_{ICM}$  is input common mode voltage when tested meets specified change in offset voltage is  $\text{CMR} \geq 76\text{dB}$ .

(A point of reference is offset voltage of  $V_{ICM} = 0\text{V}$ )

## •AC CHARACTERISTICS

( $V^+V^- = \pm 15\text{V}$ ,  $T_a = +25^\circ\text{C}$  unless otherwise specified)

PARAMETER	SYMBOL	CONDITION	MIN.	TYP.	MAX.	UNIT
Gain Bandwidth Product	GB	$f = 10\text{kHz}$	-	2.2	-	MHz
Unity Gain Frequency	$f_T$	$A_V = +100$ , $R_S = 100\Omega$ , $R_L = \infty$ , $C_L = 10\text{pF}$	-	2	-	MHz
Phase Margin	$\Phi_M$	$A_V = +100$ , $R_S = 100\Omega$ , $R_L = \infty$ , $C_L = 10\text{pF}$	-	55	-	deg
Input Noise Voltage1	$V_{NI1}$	$f = 1\text{kHz}$ , $A_V = +100$ , $R_S = 100\Omega$ , $R_L = \infty$	-	20	-	nV/ $\sqrt{\text{Hz}}$
Input Noise Voltage2	$V_{NI2}$	RIAA, $R_S = 2.2\text{k}\Omega$ , 30kHz, LPF	-	2.5	-	$\mu\text{Vrms}$
Total Harmonic Distortion	THD	$f = 1\text{kHz}$ , $A_V = +10$ , $R_S = 1\text{k}\Omega$ , $R_L = \infty$ , $V_O = 5\text{Vrms}$	-	0.005	-	%
Channel Separation	CS	$F = 1\text{kHz}$ , $A_V = -100$ , $R_S = 1\text{k}\Omega$ , $R_L = 10\text{k}\Omega$	-	120	-	dB

## •TRANSIENT CHARACTERISTICS

( $V^+V^- = \pm 15\text{V}$ ,  $T_a = +25^\circ\text{C}$  unless otherwise specified)

PARAMETER	SYMBOL	CONDITION	MIN.	TYP.	MAX.	UNIT
Positive Slew Rate	+SR	$A_V = +1$ , $V_{IN} = 2\text{Vpp}$ , $R_L = 10\text{k}\Omega$ , $C_L = 10\text{pF}$	-	14	-	$\text{V}/\mu\text{s}$
Negative Slew Rate	-SR	$A_V = +1$ , $V_{IN} = 2\text{Vpp}$ , $R_L = 10\text{k}\Omega$ , $C_L = 10\text{pF}$	-	12	-	$\text{V}/\mu\text{s}$

# NJM2749/2749A

## ■IMPORTANT CONSIDERATIONS FOR USE OF NJM2749/2749A

### ●Supply Current

When  $T_a \geq 25^\circ\text{C}$ , Power Dissipation  $P_D$  is limited by junction temperature ( $T_J=125^\circ\text{C}$ )

So maximum supply current is influenced by package, mounting board (board size, area of copper foil), Mounting condition and etc.

Following DMP8 Power Dissipation characteristic is a characteristic when mounted the following conditions supply.

- Two layer board: EIA/JEDEC 76.2×114.3×1.6mm, FR-4
- Four layer board: EIA/JEDEC 76.2×114.3×1.6mm, FR-4

Please refer to "Method of measuring the package thermal characteristic" published in our company web site for detailed information on the thermal characteristic.

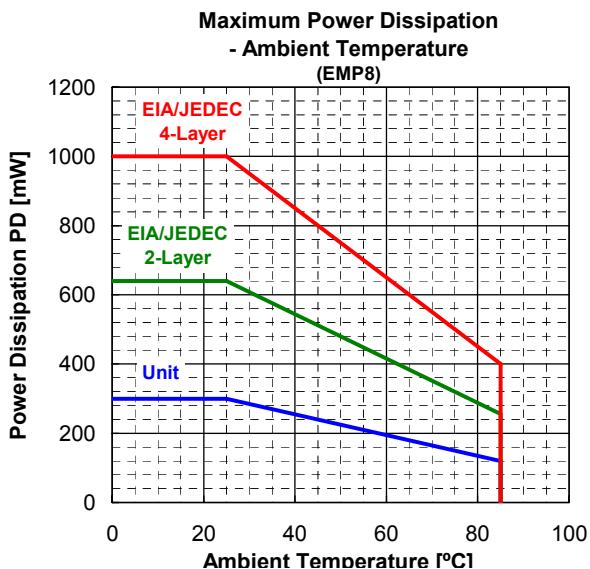
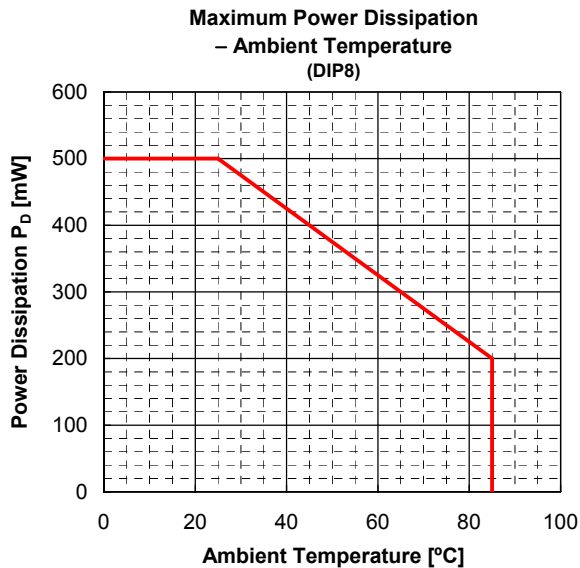
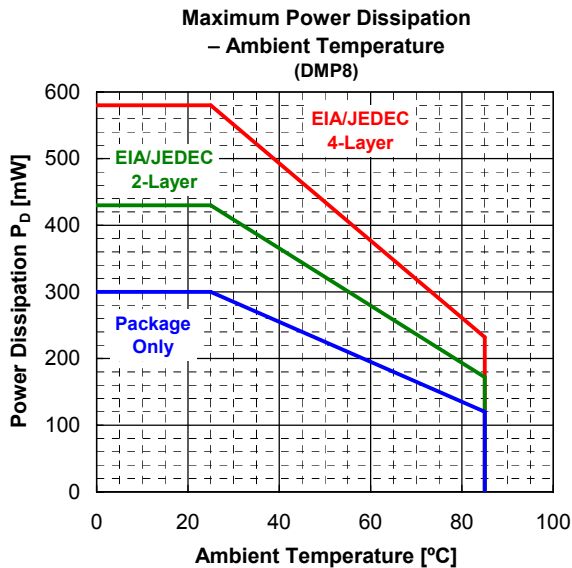

## ■IMPORTANT CONSIDERATIONS FOR USE OF NJM2749/2749A

### ●THE OSCILLATION WITH A CAPACITIVE LOAD

NJM2749/2749A tends to oscillate easily when it uses voltage-follower, and driving capacitive load.

The figure below is a "Voltage Gain - Frequency characteristic" in the Voltage-Follower. (It is not the one to guarantee the characteristic of the product.)

Especially, it becomes easy to oscillate in the condition that the input voltage (output voltage) is near the minus supply voltage side and the condition with large output sink current. We will recommend use by some circuit gains.

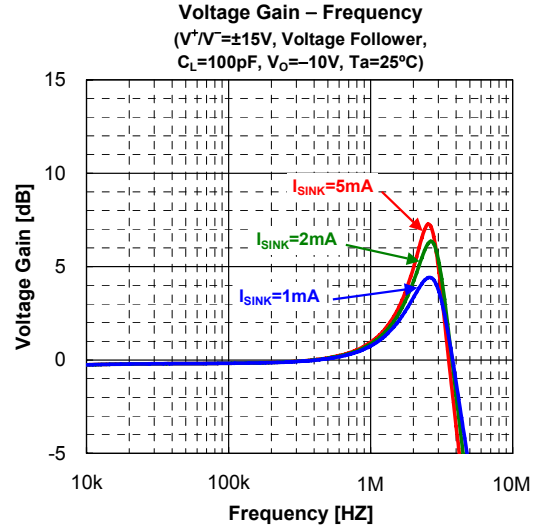
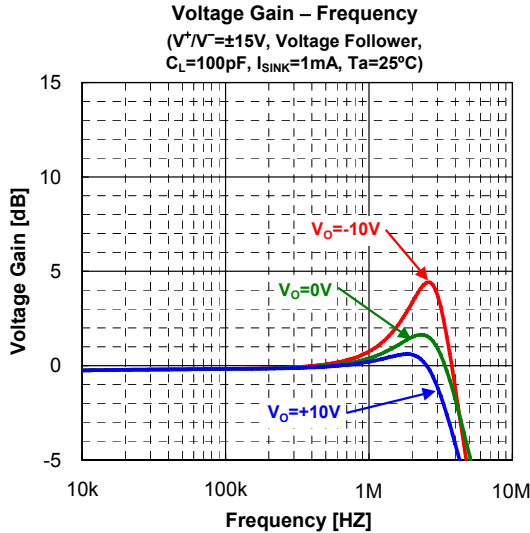

### ●INPUT COMMON MODE VOLTAGE RANGE

In this product, the input offset voltage drift is measured based on the input offset voltage at  $V_{ICM} = 0V$ , and the input voltage range that satisfies the common mode rejection ratio 76dB is defined as the input common mode voltage range.

As an electric characteristic,  $V_{ICM} = -10V \sim +10V$  at Supply Voltage  $V^+V^- = \pm 15V$  is guaranteed.

It becomes below formula about the input common mode voltage range when the supply voltage changes.

$$+V_{ICM}: (V^+ \text{ supply}) - 5 [V] \cdots \text{reference}$$

$$-V_{ICM}: (V^- \text{ supply}) + 5 [V] \cdots \text{reference}$$

This figure below is "Input common mode voltage range - Supply voltage characteristics". (It is not the one to guarantee the characteristic of the product.)

+  $V_{ICM}$  is limited by the absolute maximum rating ( $V^+$  supply) within the input common mode voltage range.

Moreover,  $-V_{ICM}$  tends to rise by lowering of the supply voltage.

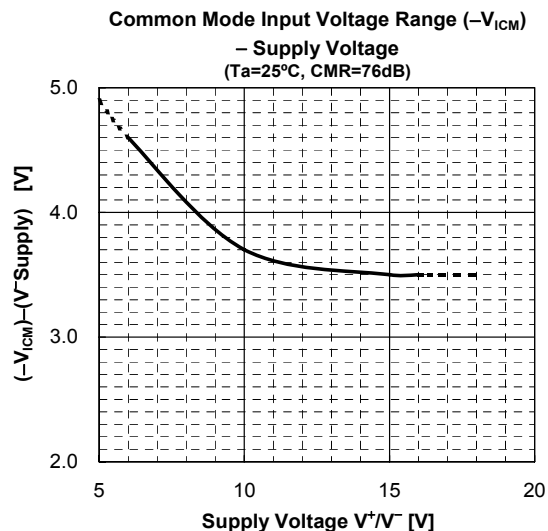
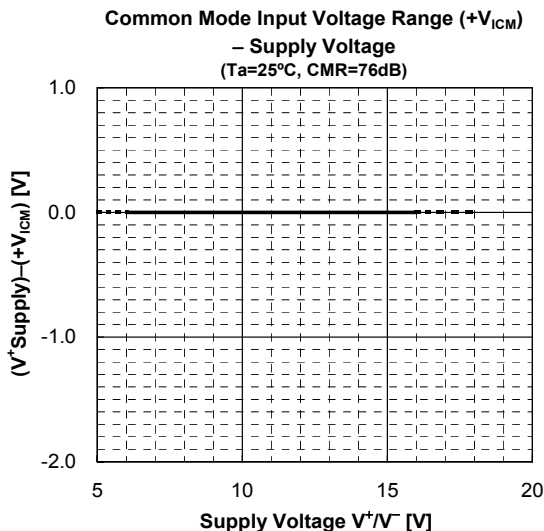

### ●OTHERS

For the NJM2749/2749A are high-precision products, a surface leak by dirt and/or condensation on package can have a detrimental effect on precise characteristics of these products.

You should pay close attention to environment of storage and usage.

# NJM2749/2749A

## TYPICAL CHARACTERISTICS

Input Offset Voltage Temperature Coefficient Distribution  
( $V^+/V^- = \pm 15V$ ,  $T_a = -40^\circ C \rightarrow +25^\circ C$ )

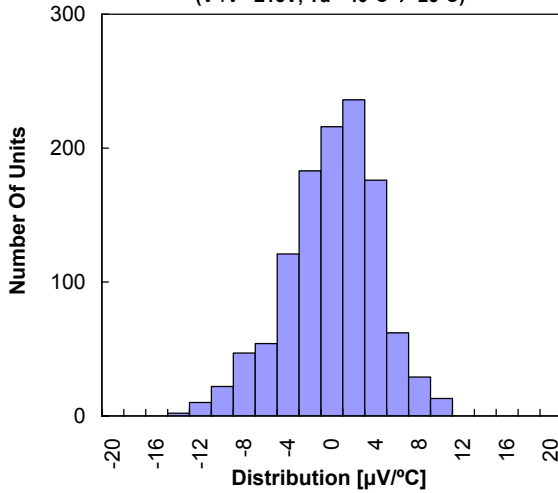

Input Offset Voltage Temperature Coefficient Distribution  
( $V^+/V^- = \pm 15V$ ,  $T_a = +25^\circ C \rightarrow +85^\circ C$ )

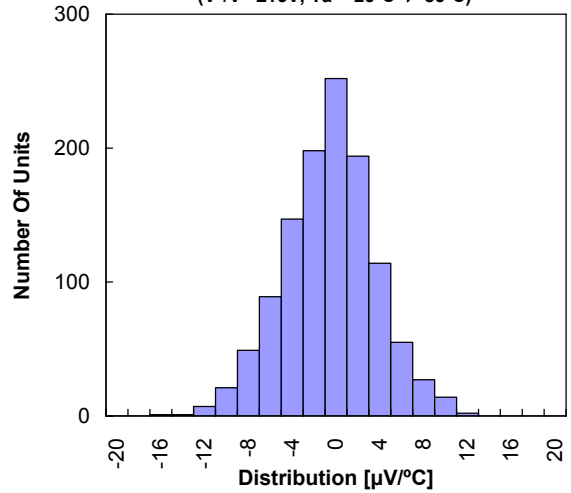

Input Offset Voltage – Ambient Temperature  
( $V^+/V^- = \pm 15V$ )

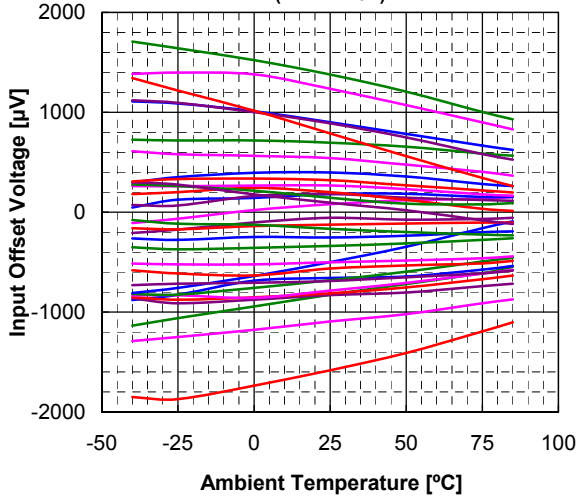

Input Offset Voltage Drift – Supply Voltage  
( $V^+/V^- = \pm 15V$  of Reference)

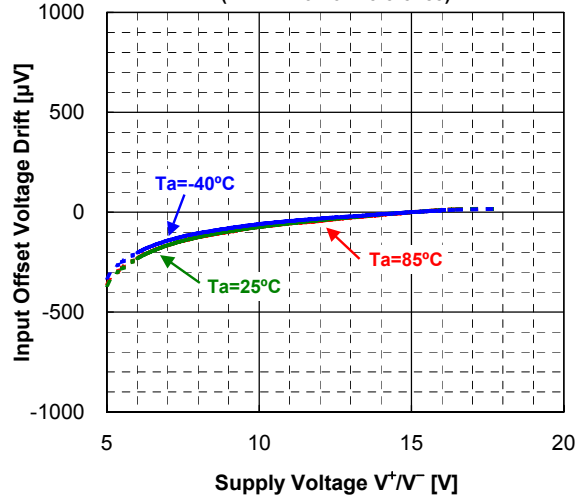

Input Offset Voltage Drift – Common Mode Input Voltage  
( $V^+/V^- = \pm 15V$ ,  $T_a = 25^\circ C$ ,  $V_{ICM} = 0V$  of Reference)

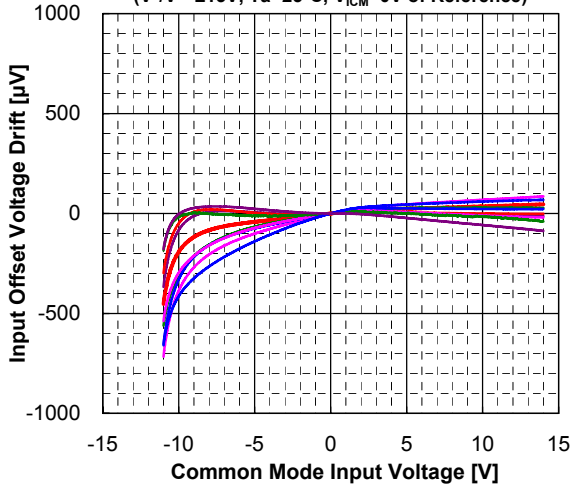

Input Offset Voltage Drift – Common Mode Input Voltage  
( $V^+/V^- = \pm 15V$ )

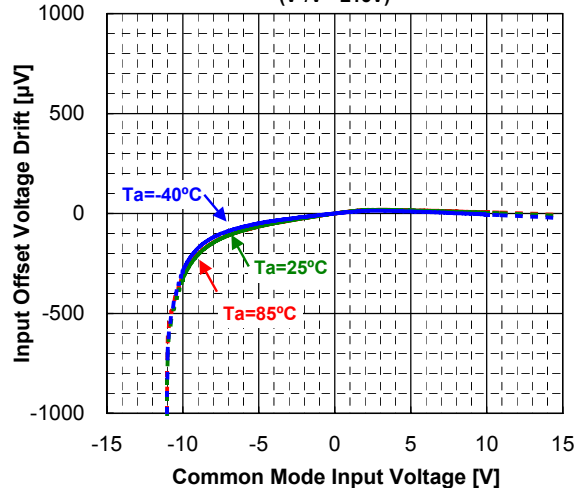

## ■ TYPICAL CHARACTERISTICS

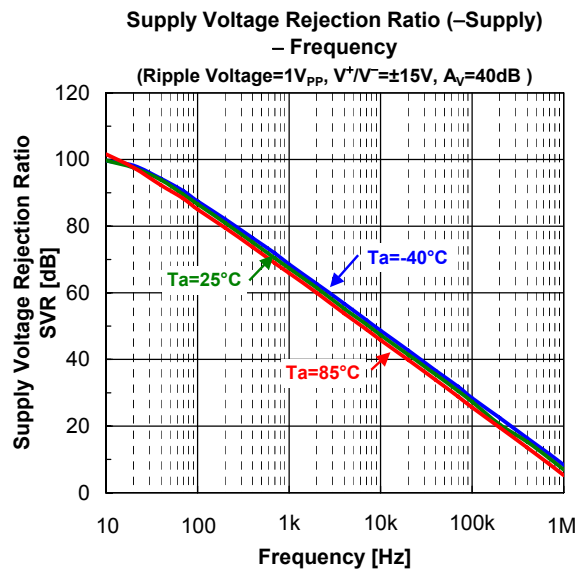
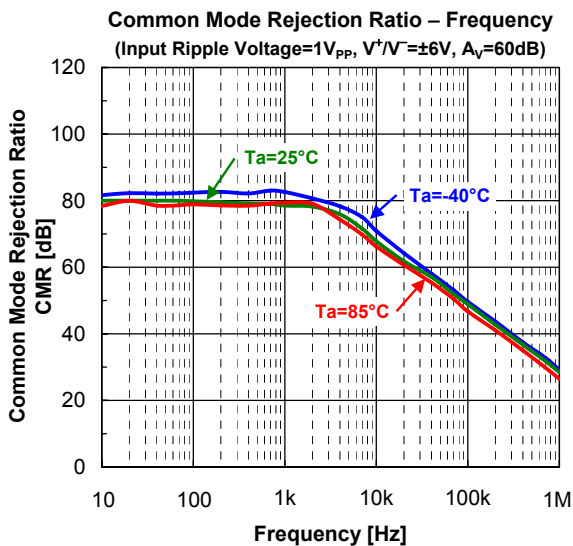
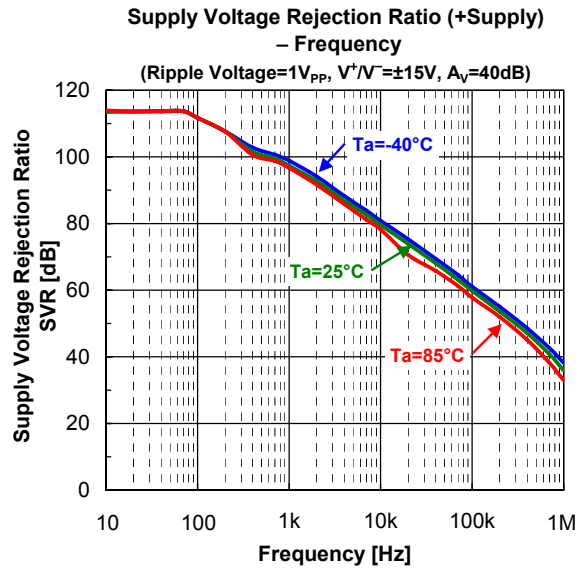
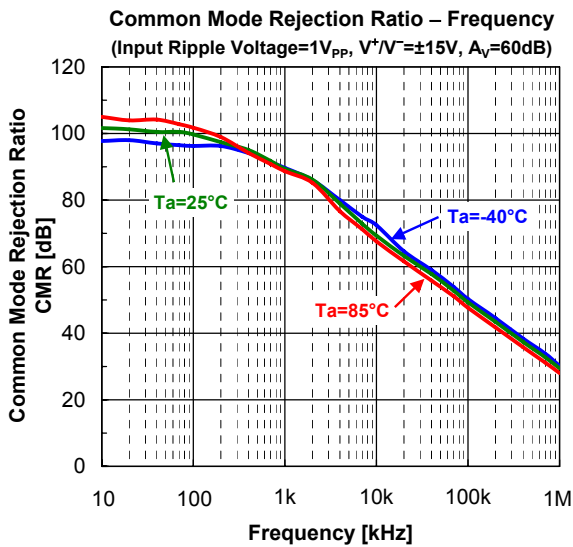
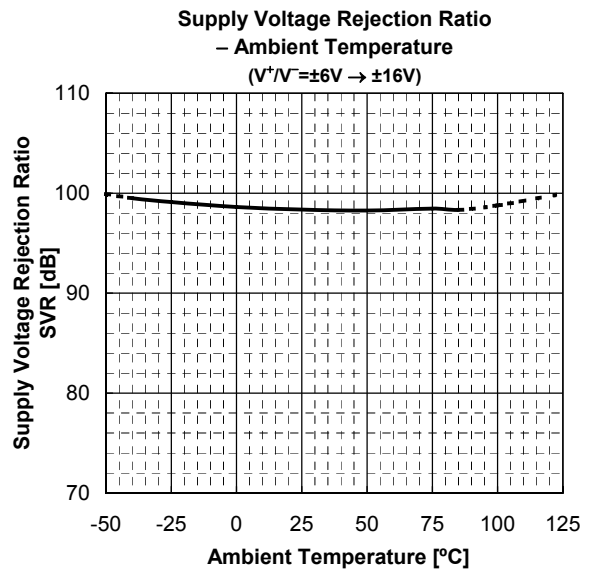
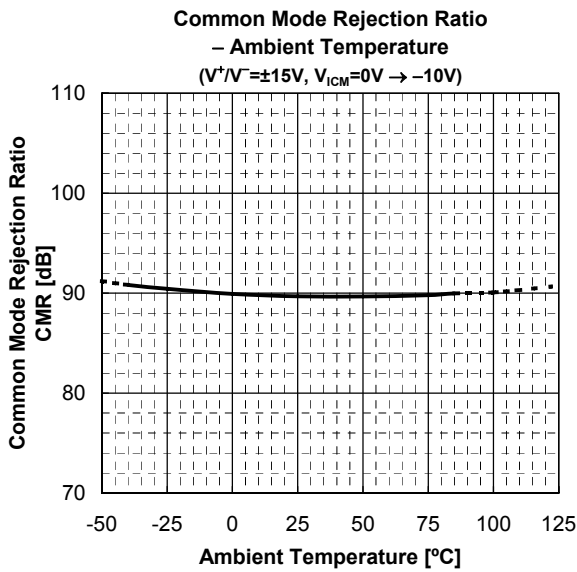

# NJM2749/2749A

## TYPICAL CHARACTERISTICS

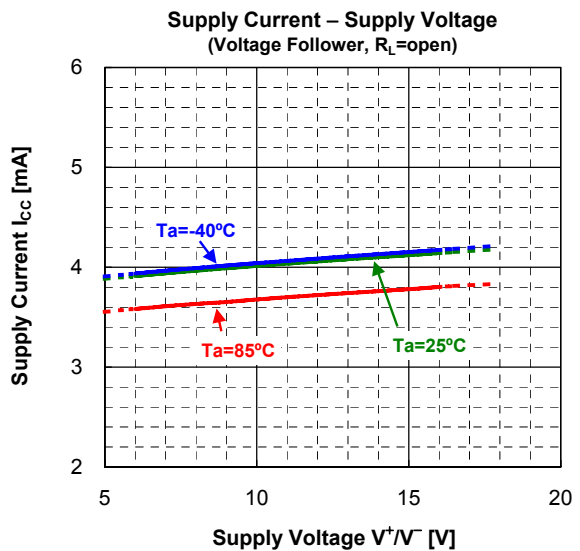
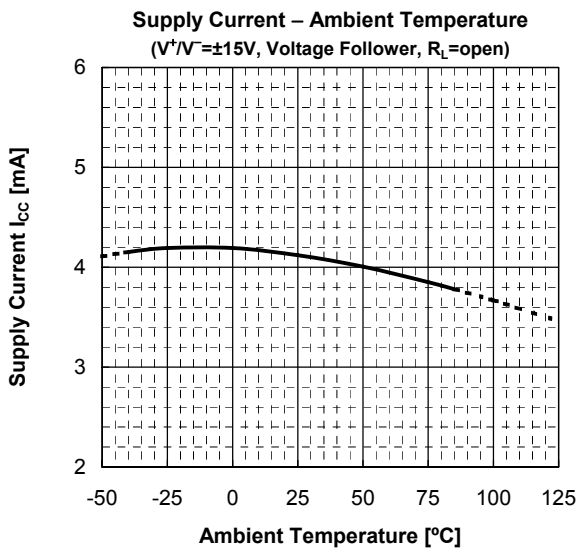
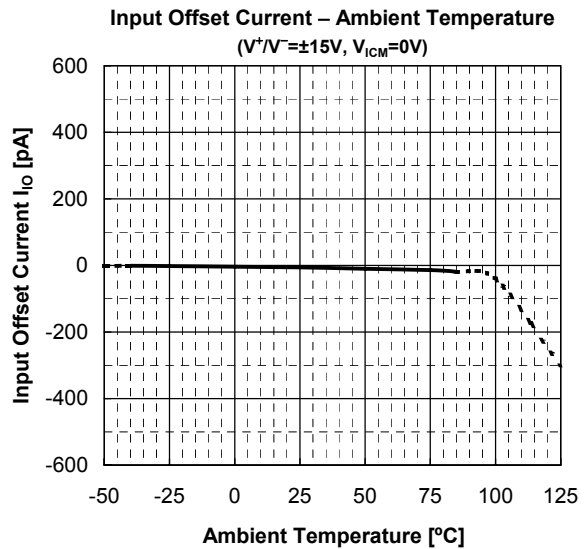
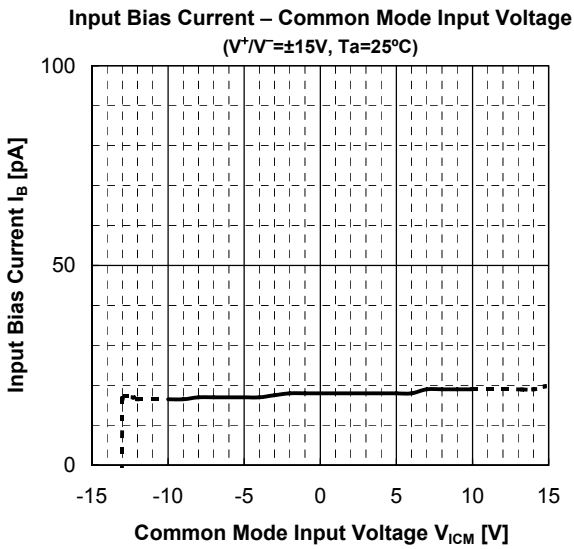
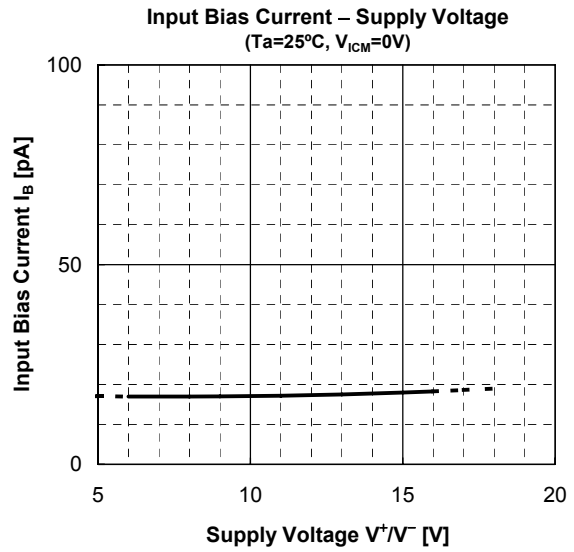
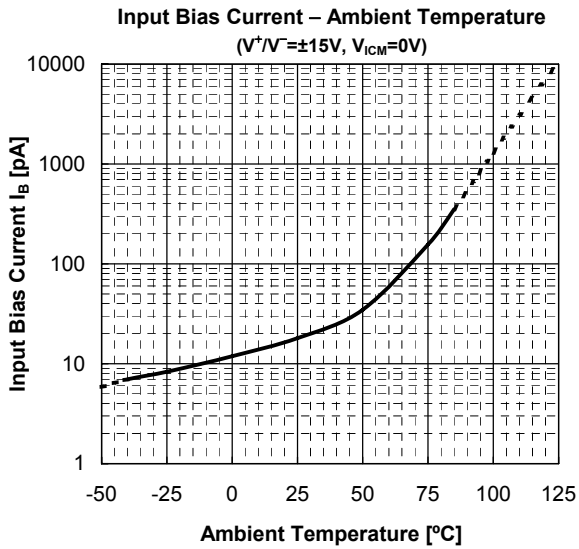



## TYPICAL CHARACTERISTICS

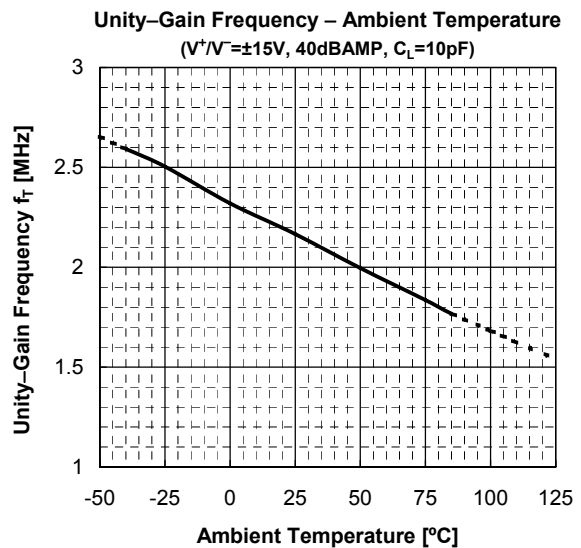
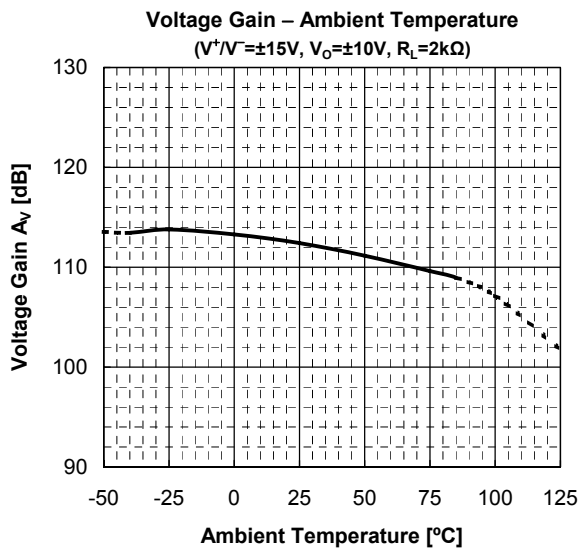
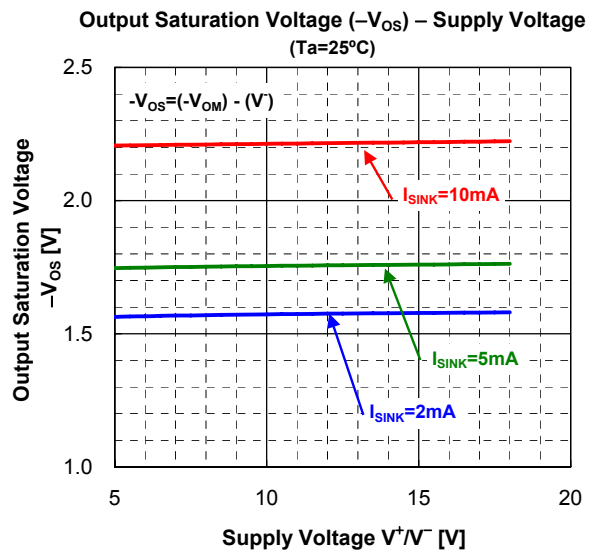
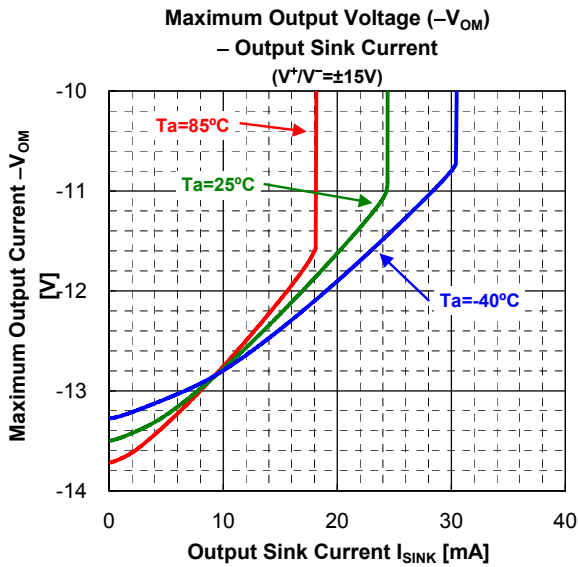
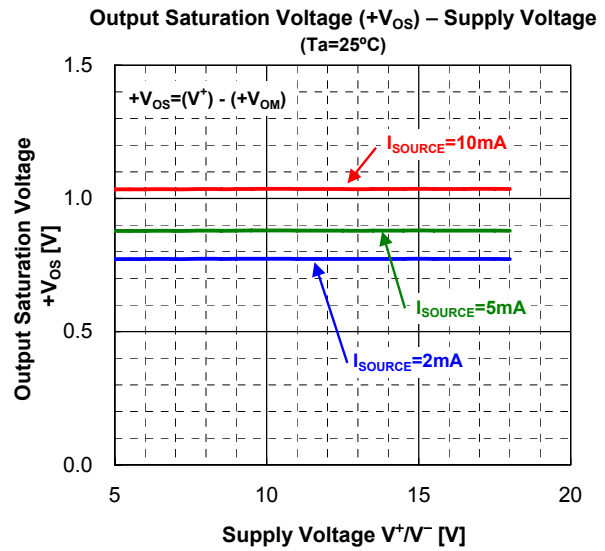
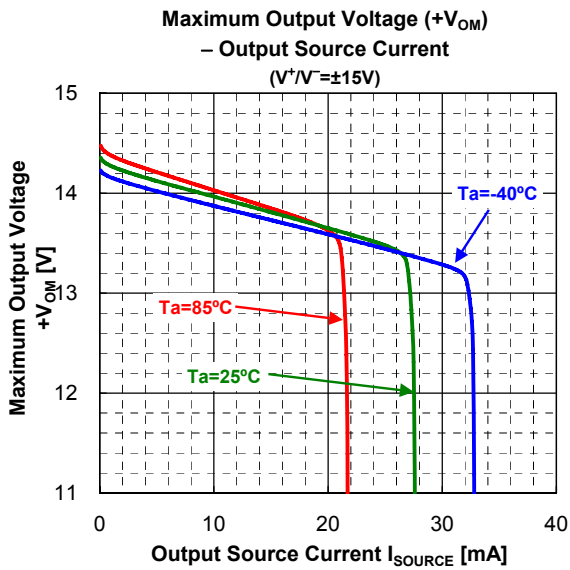

# NJM2749/2749A

## TYPICAL CHARACTERISTICS

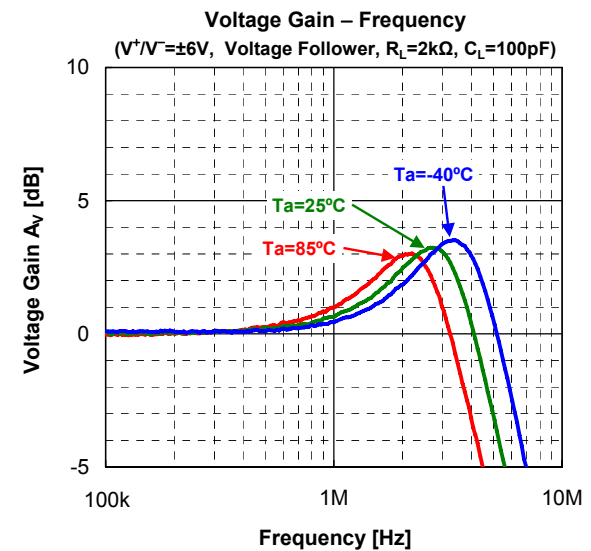
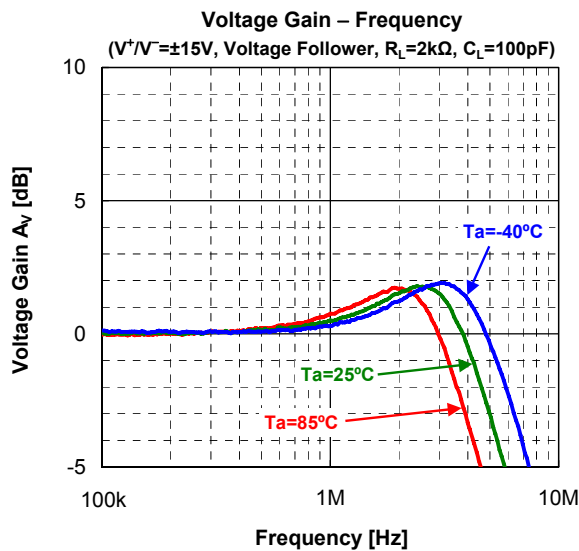
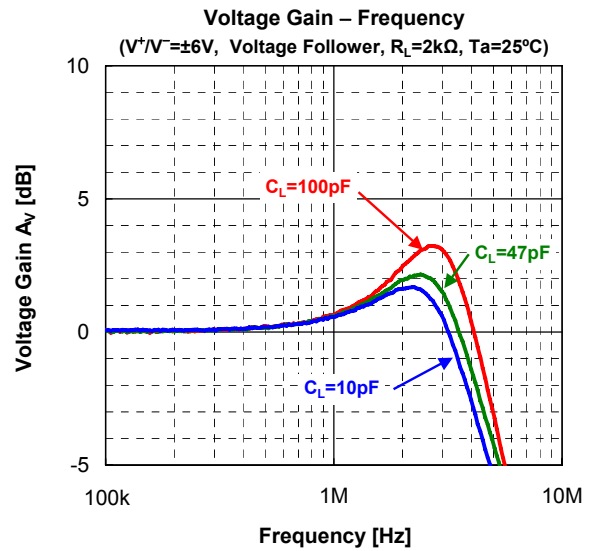
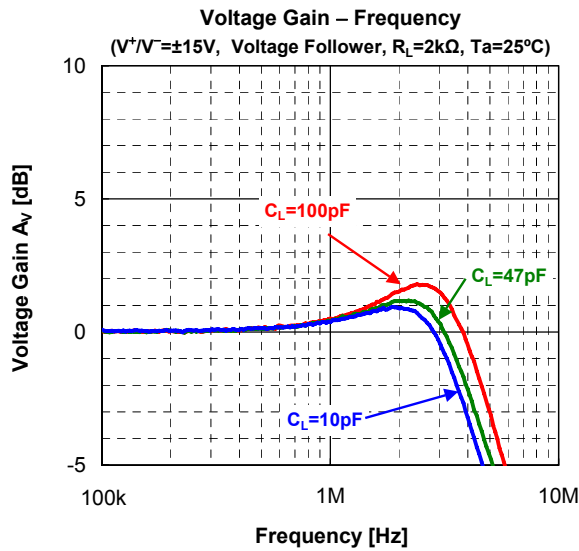
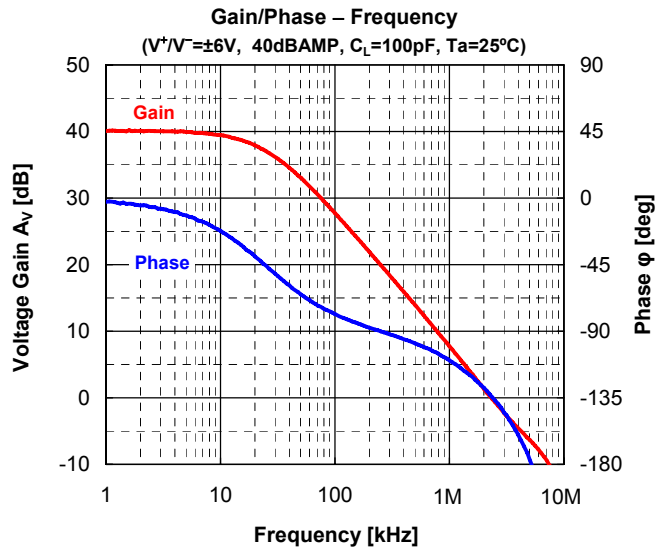
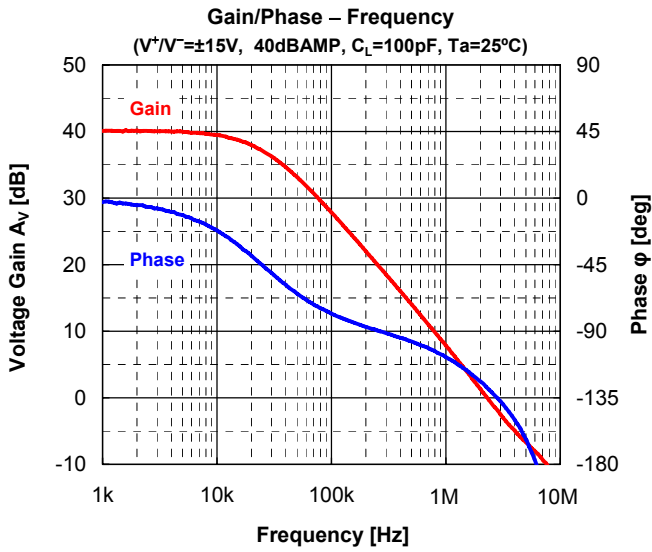

## ■ TYPICAL CHARACTERISTICS

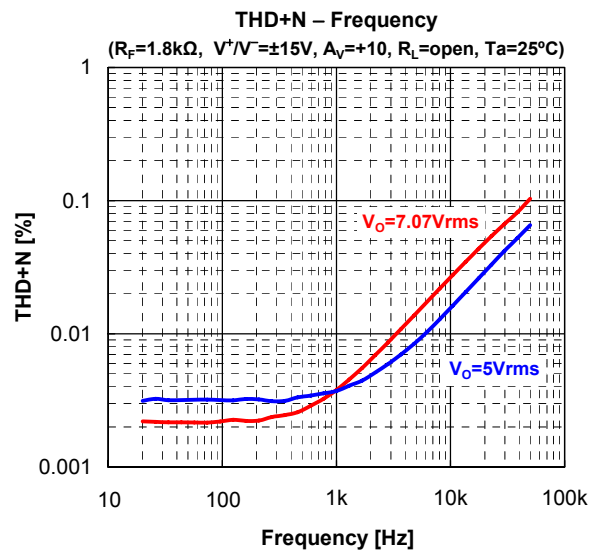
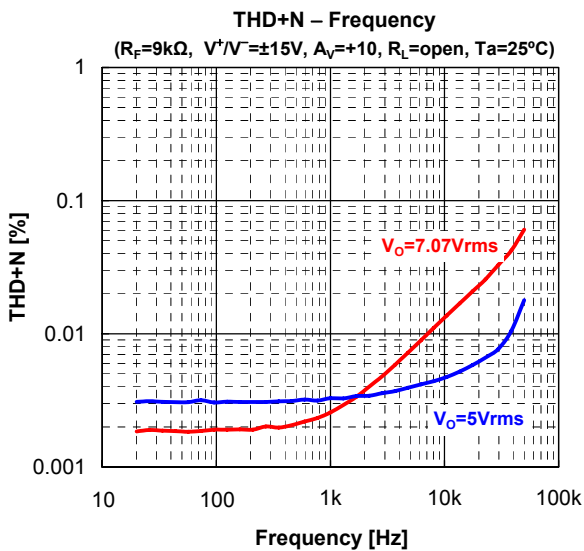
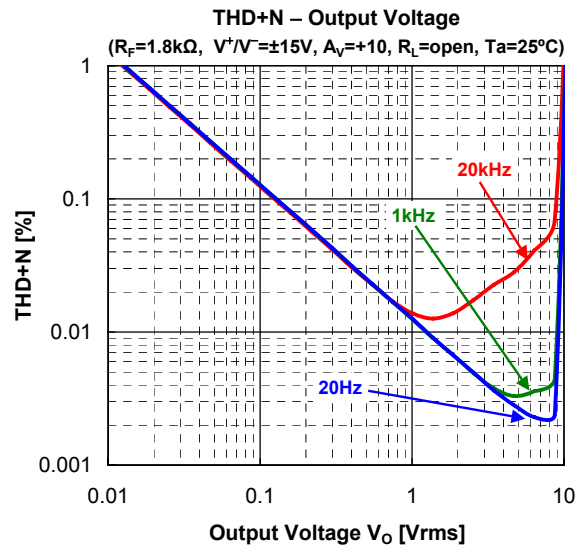
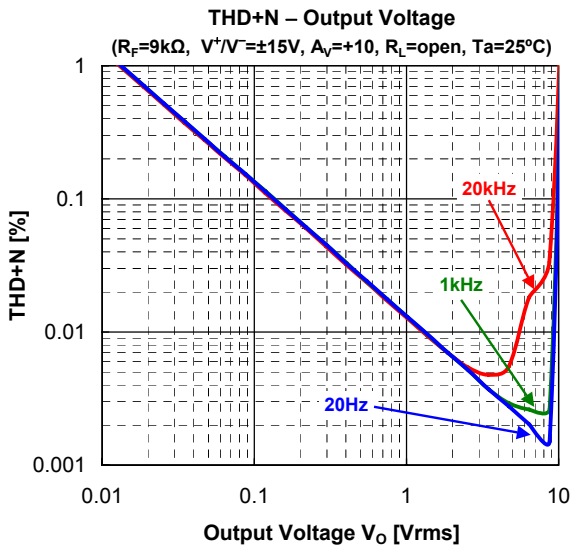
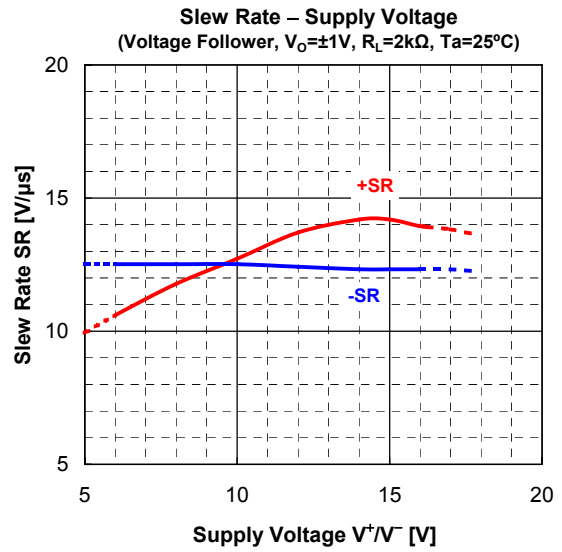
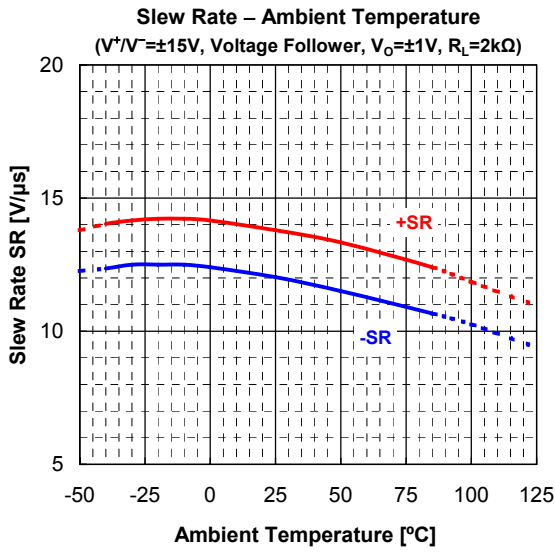

# NJM2749/2749A

## TYPICAL CHARACTERISTICS

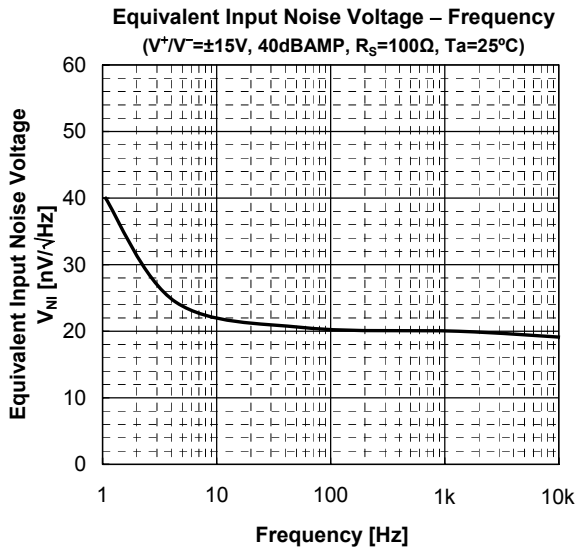

[CAUTION]  
The specifications on this data book are only given for information, without any guarantee as regards either mistakes or omissions. The application circuits in this data book are described only to show representative usages of the product and not intended for the guarantee or permission of any right including the industrial rights.