

## LOW DROPOUT VOLTAGE REGULATOR

### ■ GENERAL DESCRIPTION

The NJM2819A is a low dropout voltage regulator with ON/OFF control.

Advanced Bipolar technology achieves low noise, high ripple rejection and low quiescent current.

It delivers up to 7V/2A output power with the maximum input voltage of 10V.

The NJM2819A is suitable for audio/video and digital applications.

### ■ PACKAGE OUTLINE

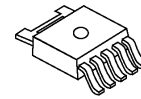

NJM2819ADL3

### ■ FEATURES

- High Ripple Rejection      65dB typ. (f=1kHz,3V Version)
- Output Noise Voltage       $V_{no}=42\mu V_{rms}$  typ. ( $V_o=3V$  Version)
- Output capacitor with 4.7 $\mu F$  ceramic capacitor ( $V_o\geq 2.1V$ )
- Output Current               $I_o(max.)=2.0A$
- High Precision Output       $V_o \pm 1.0\%$
- Low Dropout Voltage      0.1V typ. ( $I_o=1.0A$ , 3.0V Version)
- ON/OFF Control
- Internal Short Circuit Current Limit
- Internal Thermal Overload Protection
- Package Outline              TO-252-5

### ■ PIN CONFIGURATION

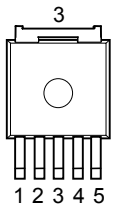

1.  $V_{IN}$
2. CONTROL
3.  $V_o$
4. N.C.
5. GND

NJM2819ADL3

### ■ EQUIVALENT CIRCUIT

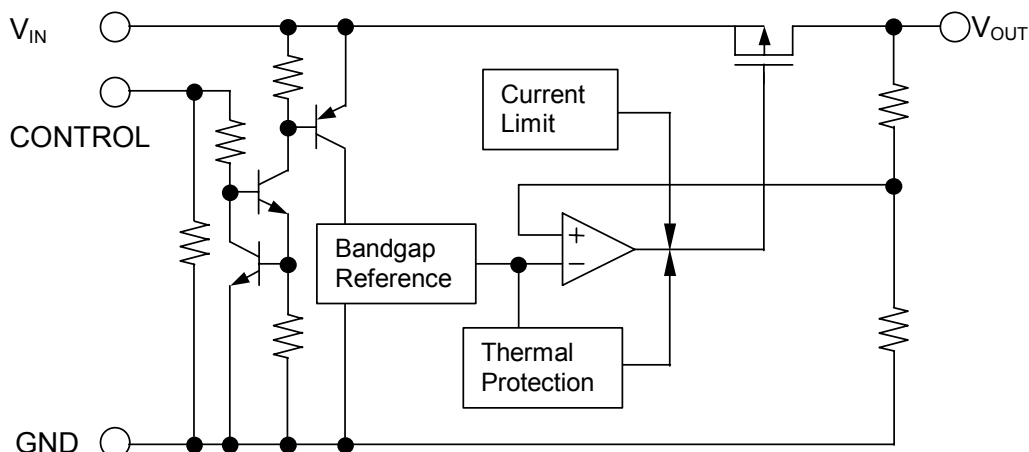

# NJM2819A

## ■ OUTPUT VOLTAGE RANK LIST

Device Name	V <sub>OUT</sub>
NJM2819ADL3-18	1.8V
NJM2819ADL3-21	2.1V
NJM2819ADL3-03	3.0V
NJM2819ADL3-33	3.3V
NJM2819ADL3-05	5.0V
NJM2819ADL3-52	5.2V
NJM2819ADL3-07	7.0V

Output voltage options available : 1.8 ~ 7.0V

## ■ ABSOLUTE MAXIMUM RATINGS

(Ta=25°C)

PARAMETER	SYMBOL	RATINGS	UNIT
Input Voltage	V <sub>IN</sub>	V <sub>O</sub> > 6.0V: +10 5.0V < V <sub>O</sub> ≤ 6.0V: +9V V <sub>O</sub> ≤ 5.0V: +8	V
Control Voltage	V <sub>CONT</sub>	V <sub>O</sub> > 6.0V: +10 5.0V < V <sub>O</sub> ≤ 6.0V: +9V V <sub>O</sub> ≤ 5.0V: +8	V
Power Dissipation	P <sub>D</sub>	1190(*1) 3125(*2)	mW
Operating Temperature	Topr	-40 ~ +85	°C
Storage Temperature	Tstg	-40 ~ +150	°C

(\*1) : Mounted on glass epoxy board. (76.2×114.3×1.6mm:EIA/JDEC standard size, 2Layers, copper area 100mm<sup>2</sup>)

(\*2) : Mounted on glass epoxy board. (76.2×114.3×1.6mm:EIA/JDEC standard size, 4Layers, copper area 100mm<sup>2</sup>)

(4Layers inner foil : 74.2 x 74.2mm Applying a thermal beer hall to a board based on JEDEC standard JESD51-5)

## ■ OPERATING VOLTAGE

V<sub>IN</sub>=V<sub>O</sub> + ΔV<sub>I-O</sub> ~ 9V (In case of V<sub>O</sub> > 6.0V version)

V<sub>IN</sub>=V<sub>O</sub> + ΔV<sub>I-O</sub> ~ 8V (In case of 5.0V < V<sub>O</sub> ≤ 6.0V version)

V<sub>IN</sub>=V<sub>O</sub> + ΔV<sub>I-O</sub> ~ 7V (In case of 2.1V ≤ V<sub>O</sub> ≤ 5.0V version)

V<sub>IN</sub>=2.3V ~ 7V (In case of V<sub>O</sub> < 2.1V version)

■ ELECTRICAL CHARACTERISTICS ( $V_{IN}=V_O+1V$ ,  $C_{IN}=4.7\mu F$ ,  $C_O=4.7\mu F$ ( $C_O=10\mu F$  :  $1.8V \leq V_O < 2.1V$ ),  $T_a=25^\circ C$ )

PARAMETER	SYMBOL	TEST CONDITION	MIN.	TYP.	MAX.	UNIT	
Output Voltage	$V_O$	$I_O=100mA$	-1.0%	-	+1.0%	V	
Quiescent Current	$I_Q$	$I_O=0mA$ , exclude $I_{CONT}$	-	500	800	$\mu A$	
Quiescent Current at Control OFF	$I_{Q(OFF)}$	$V_{CONT}=0V$	-	-	1	$\mu A$	
Output Current	$I_O$	$V_O - 0.3V$	2	3	-	A	
Line Regulation	$\Delta V_O / \Delta V_{IN}$	$V_O > 5.0V$ : $V_{IN}=V_O+1V \sim 9V$ , $5.0V < V_O \leq 6.0V$ : $V_{IN}=V_O+1V \sim 8V$ , $V_O \leq 5.0V$ : $V_{IN}=V_O+1V \sim 7V$ , $I_O=100mA$	-	-	0.1	%/V	
Load Regulation	$\Delta V_O / \Delta I_O$	$I_O=0 \sim 2.0A$	-	0.05	0.4	%/A	
Dropout Voltage(*2)	$\Delta V_{I-O}$	$I_O=1.0A$	$2.1V \leq V_O < 2.5V$	-	0.14	0.25	V
			$2.5V \leq V_O < 2.8V$	-	0.11	0.20	
			$2.8V \leq V_O < 3.4V$	-	0.10	0.18	
			$3.4V \leq V_O \leq 7.0V$	-	0.09	0.16	
Ripple Rejection	RR	$e_{in}=200mV_{rms}$ , $f=1kHz$ , $I_O=100mA$ , $V_O=3V$ Version	-	65	-	dB	
Average Temperature Coefficient of Output Voltage	$\Delta V_O / \Delta T_a$	$T_a=0 \sim 85^\circ C$ , $I_O=100mA$	-	$\pm 50$	-	ppm/ $^\circ C$	
Output Noise Voltage	$V_{NO}$	$f=10Hz \sim 80kHz$ , $I_O=100mA$ , $V_O=3V$ Version	-	42	-	$\mu V_{rms}$	
Control Current	$I_{CONT}$	$V_{CONT}=1.6V$	-	3	12	$\mu A$	
Control Voltage for ON-state	$V_{CONT(ON)}$		1.6	-	-	V	
Control Voltage for OFF-state	$V_{CONT(OFF)}$		-	-	0.6	V	
Minimum Input Voltage	$V_{IN(MIN)}$	$V_O < 2.1V$	$I_O \leq 1.5A$ , $V_O \times 0.96$	2.3	-	-	V
			$1.5A < I_O \leq 2.0A$ , $V_O \times 0.96$	2.4	-	-	V

(\*2): The output voltage excludes under 2.1V.

The above specification is a common specification for all output voltages.

Therefore, it may be different from the individual specification for a specific output voltage.

# NJM2819A

## POWER DISSIPATION vs. AMBIENT TEMPERATURE

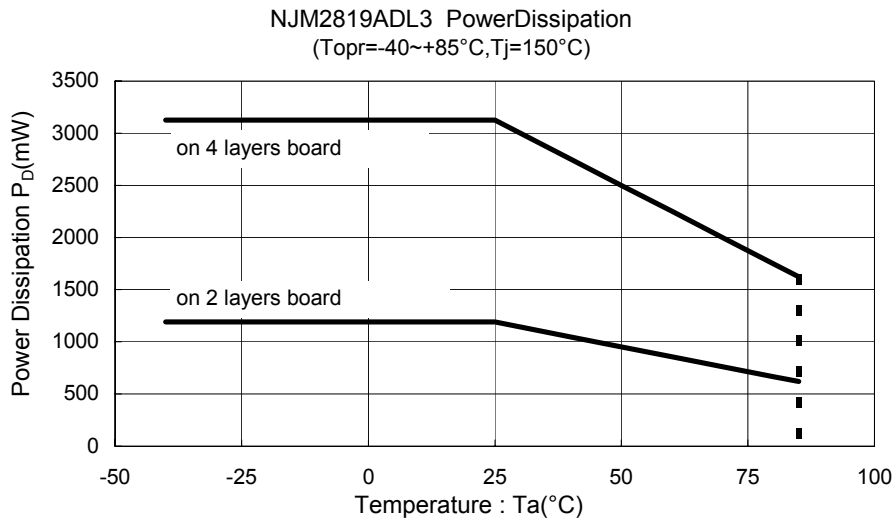

## TEST CIRCUIT

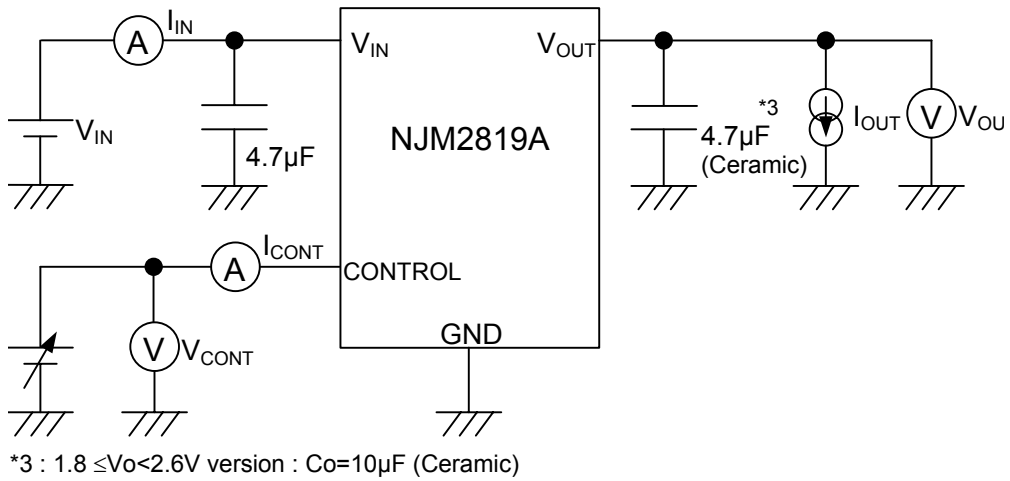

## ■ TYPICAL APPLICATION

① In the case where ON/OFF Control is not required:

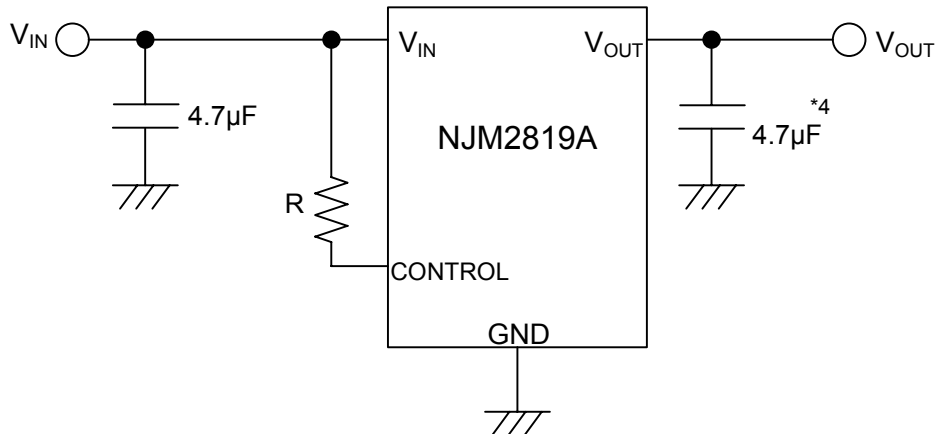

\*4 :  $1.8 \leq V_o < 2.6V$  version :  $C_o = 10\mu F$

Connect control terminal to  $V_{IN}$  terminal

② In use of ON/OFF CONTROL:

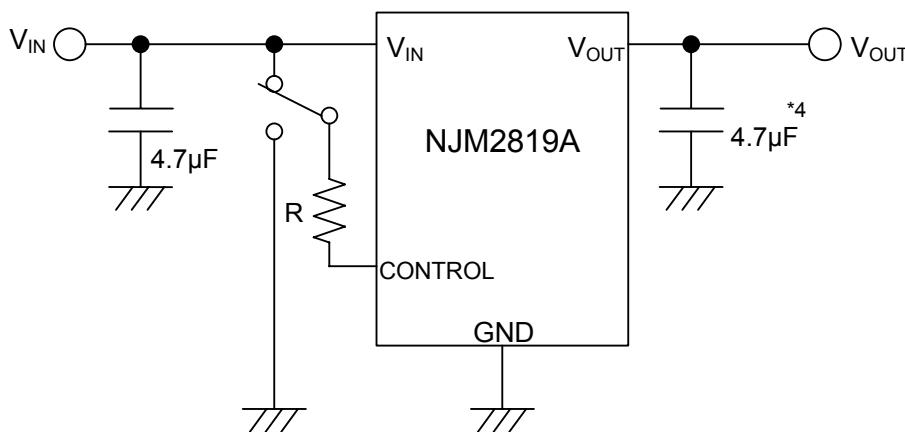

\*4 :  $1.8 \leq V_o < 2.6V$  version :  $C_o = 10\mu F$

State of control terminal:

- "H" → output is enabled.
- "L" or "open" → output is disabled.

\*In the case of using a resistance "R" between  $V_{IN}$  and control.

The current flow into the control terminal while the IC is ON state ( $I_{CONT}$ ) can be reduced when a pull up resistance "R" is inserted between  $V_{IN}$  and the control terminal.

The minimum control voltage for ON state ( $V_{CONT(ON)}$ ) is increased due to the voltage drop caused by  $I_{CONT}$  and the resistance "R". The  $I_{CONT}$  is temperature dependence as shown in the "Control Current vs. Temperature" characteristics. Therefore, the resistance "R" should be carefully selected to ensure the control voltage exceeds the  $V_{CONT(ON)}$  over the required temperature range.

# NJM2819A

---

## \*Input Capacitance $C_{IN}$

Input Capacitance  $C_{IN}$  is required to prevent oscillation and reduce power supply ripple for applications with high power supply impedance or a long power supply line.

Use the  $C_{IN}$  value of 4.7 $\mu$ F greater to avoid the problem.

$C_{IN}$  should connect between GND and  $V_{IN}$  as short as possible.

## \*Output Capacitance $C_O$

Output capacitor ( $C_O$ ) is required for a phase compensation of the internal error amplifier. The capacitance and the equivalent series resistance (ESR) influence stability of the regulator.

If use a smaller  $C_O$ , it may cause excess output noise or oscillation of the regulator due to lack of the phase compensation. Therefore, use  $C_O$  with the recommended capacitance or greater value and connect between  $V_O$  terminal and GND terminal with minimal wiring.

The recommended capacitance depends on the output voltage. Low voltage regulator requires greater value of the  $C_O$ . Thus, check the recommended capacitance for each output voltage.

Use of a greater  $C_O$  reduces output noise and ripple output, and also improves transient response of the output voltage against rapid load change.

This product is designed to work with any capacitor including a low ESR capacitor for the  $C_O$ ; however, refer "Equivalent Series Resistance vs. Output Current" and choose suitable capacitor.

- \* When distance from an IC to load is long, an IC may cause malfunction by wiring capacity and an L ingredient  
Please use it after having evaluated it enough.

## TYPICAL CHARACTERISTICS

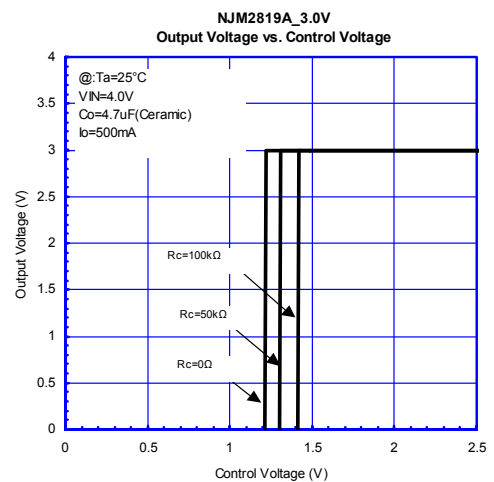
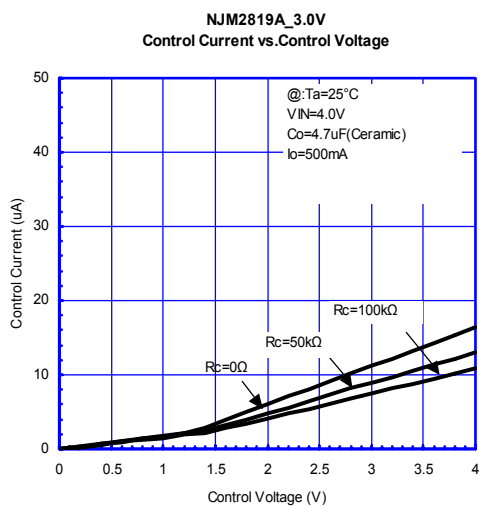
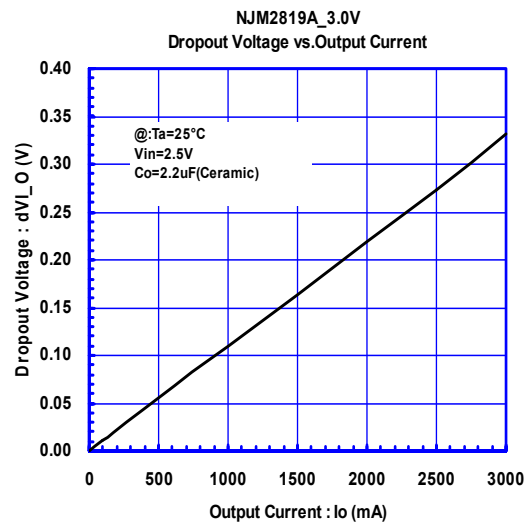
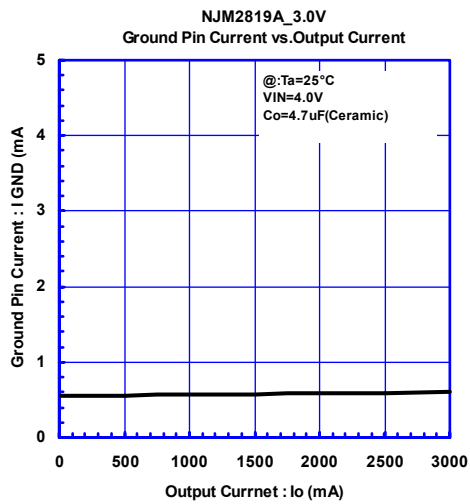
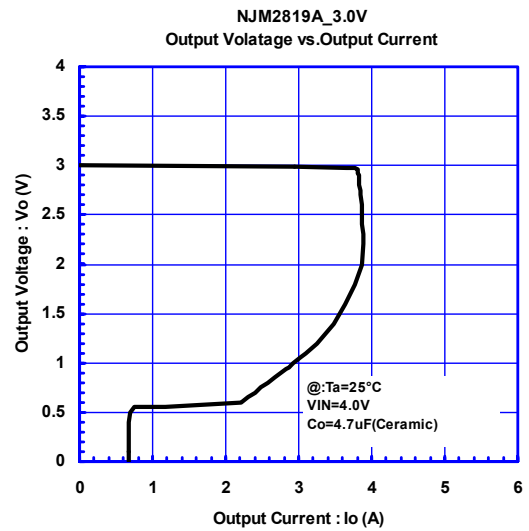
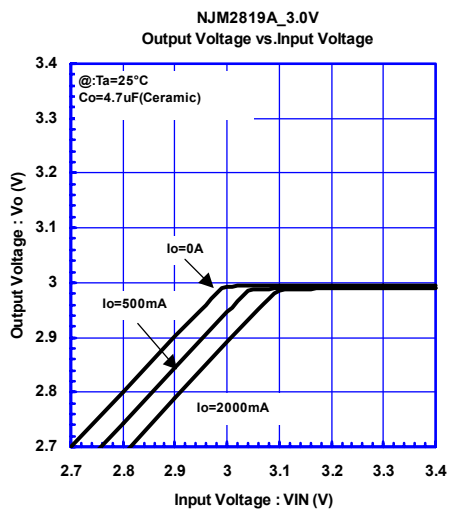

# NJM2819A

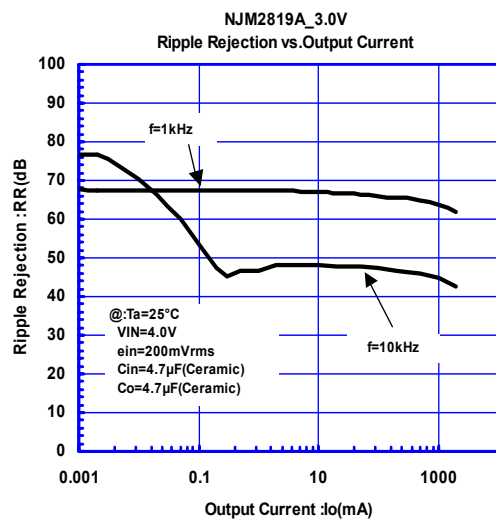
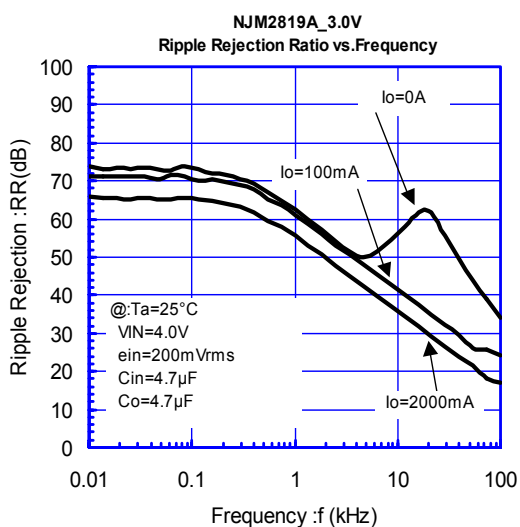
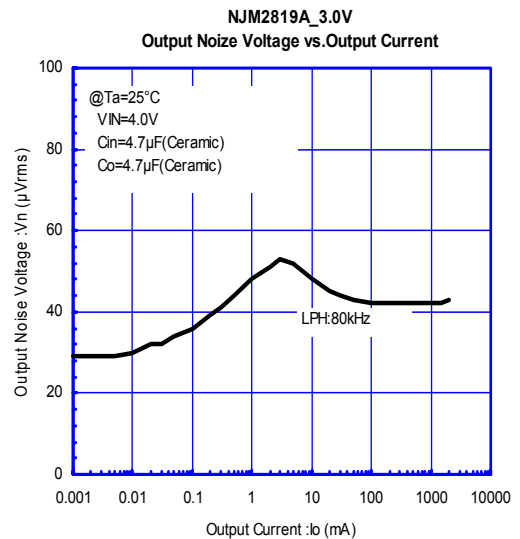
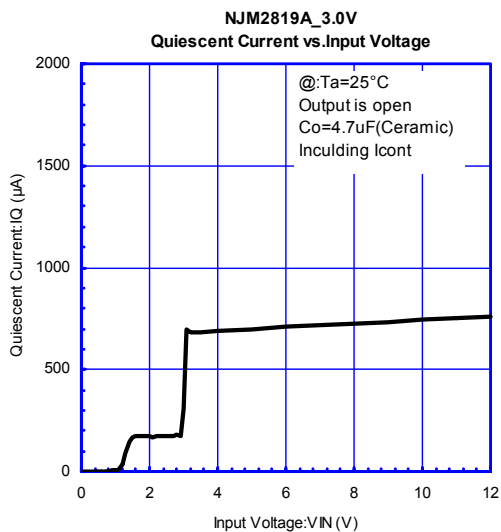
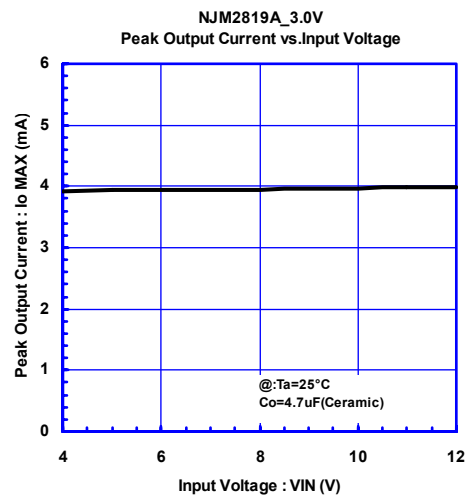
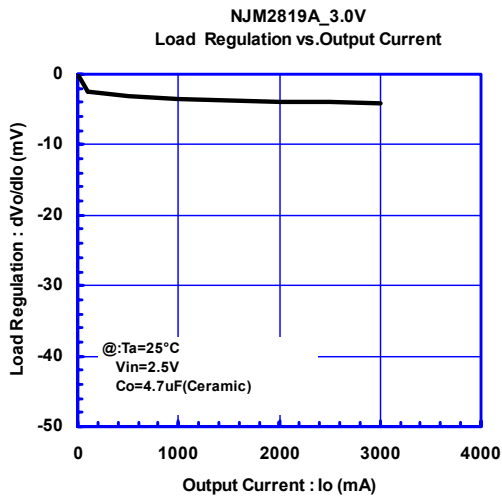



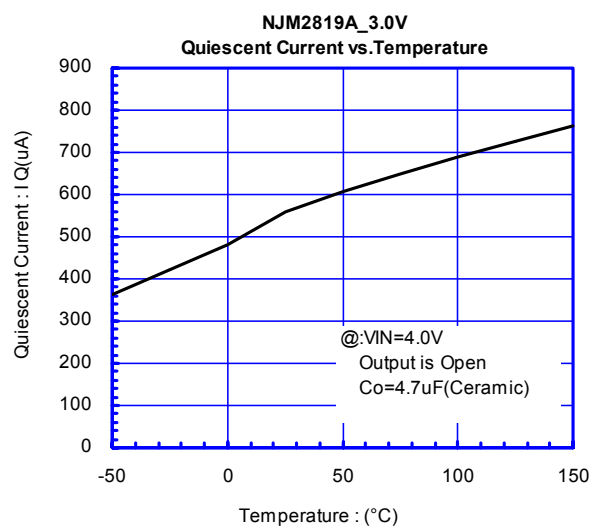
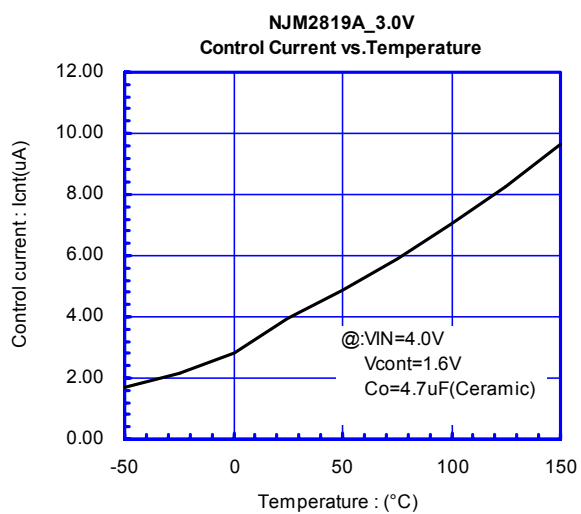
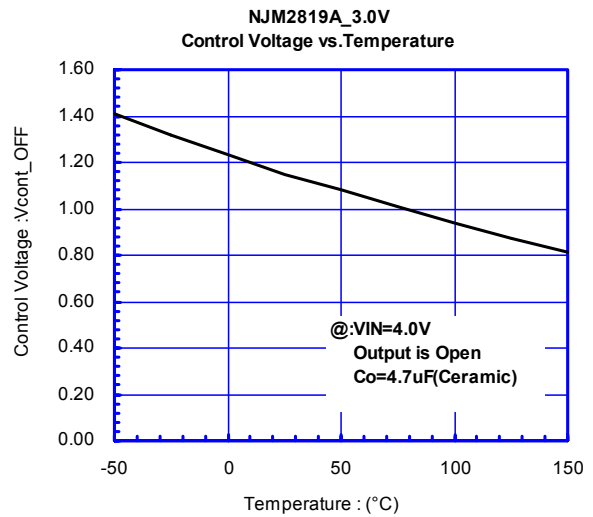
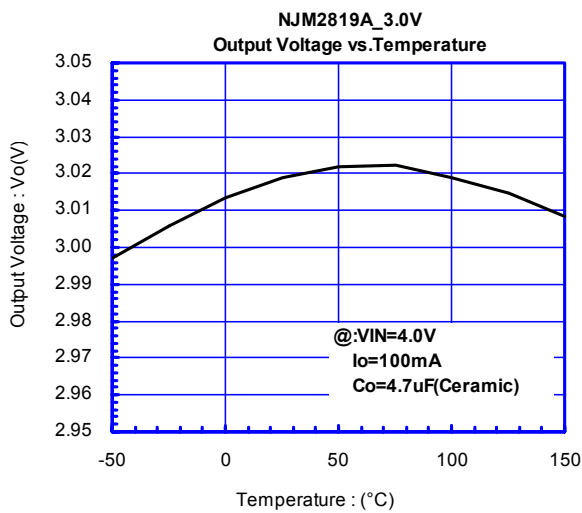
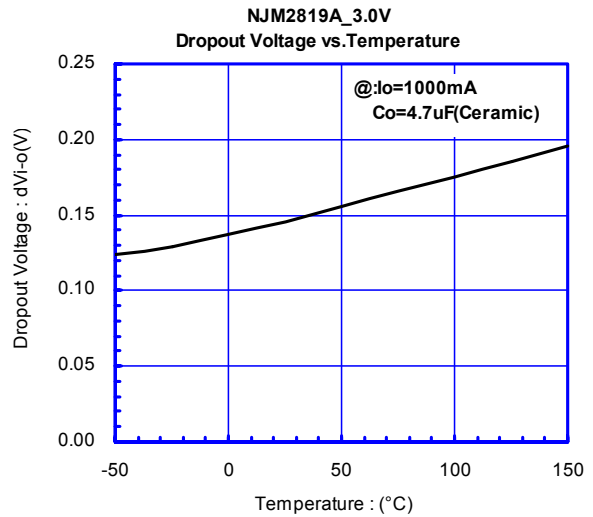
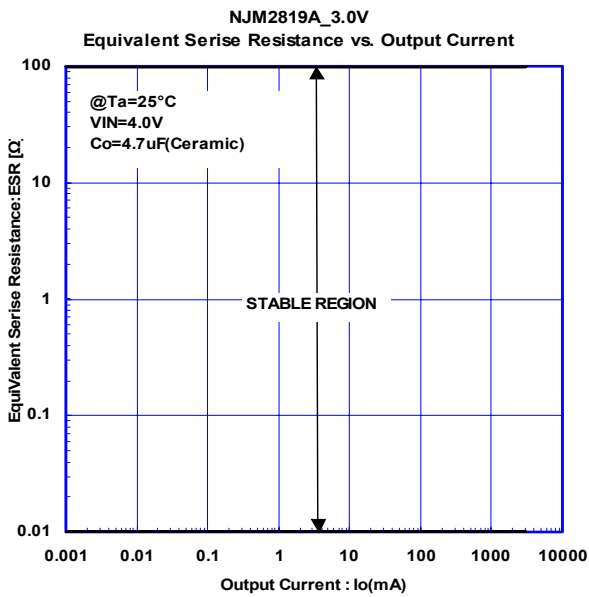

# NJM2819A

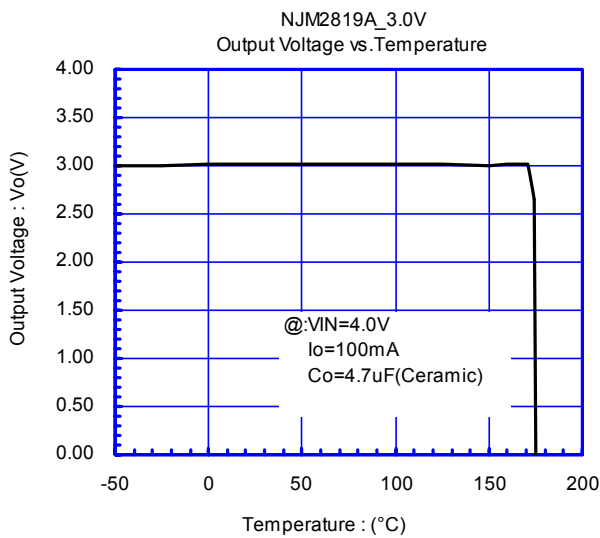
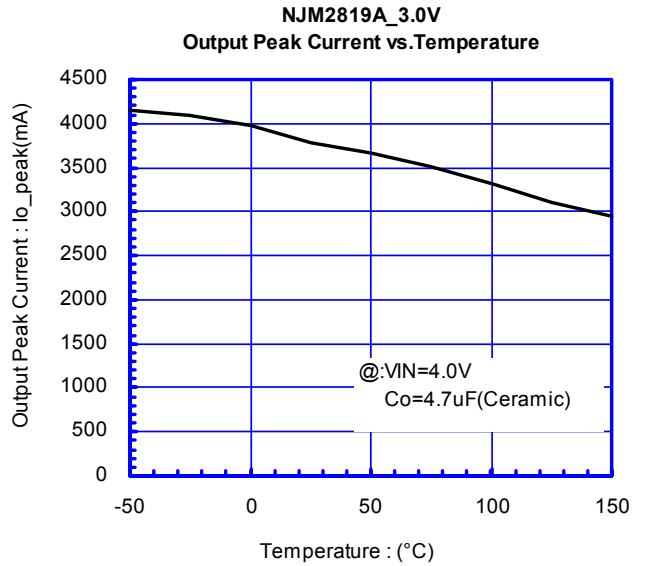
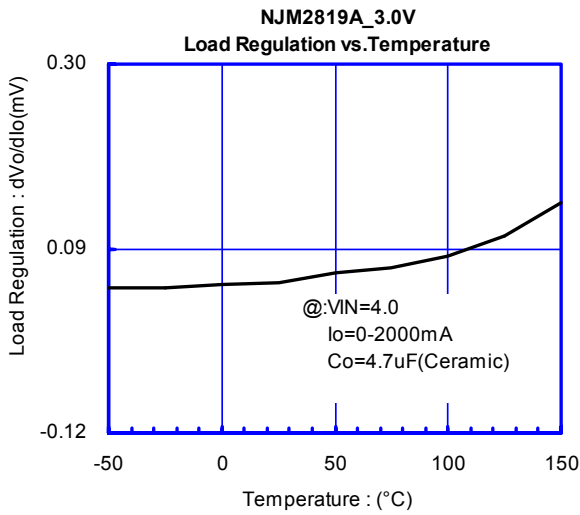
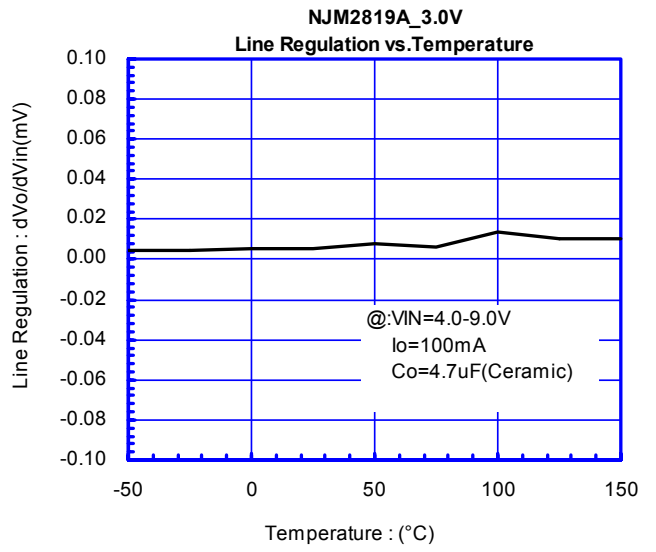
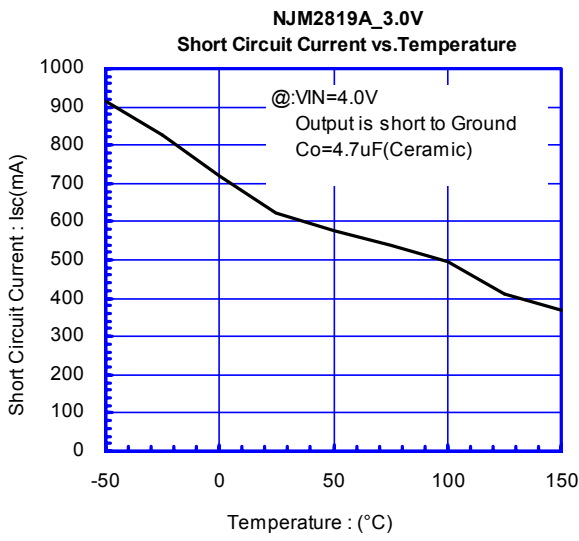

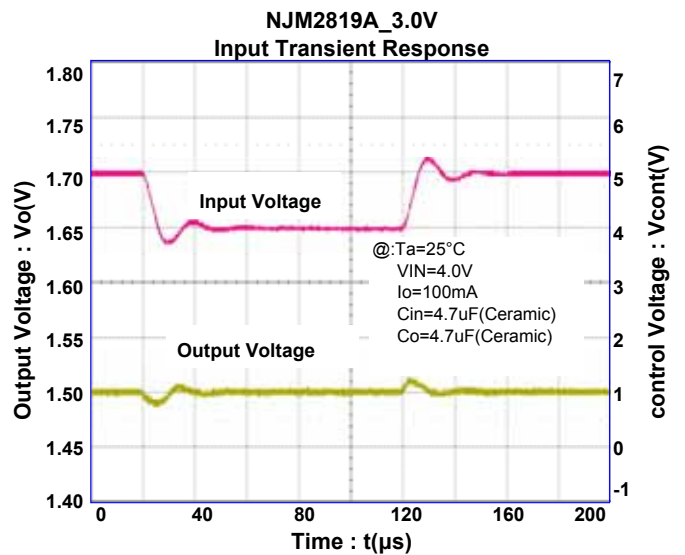
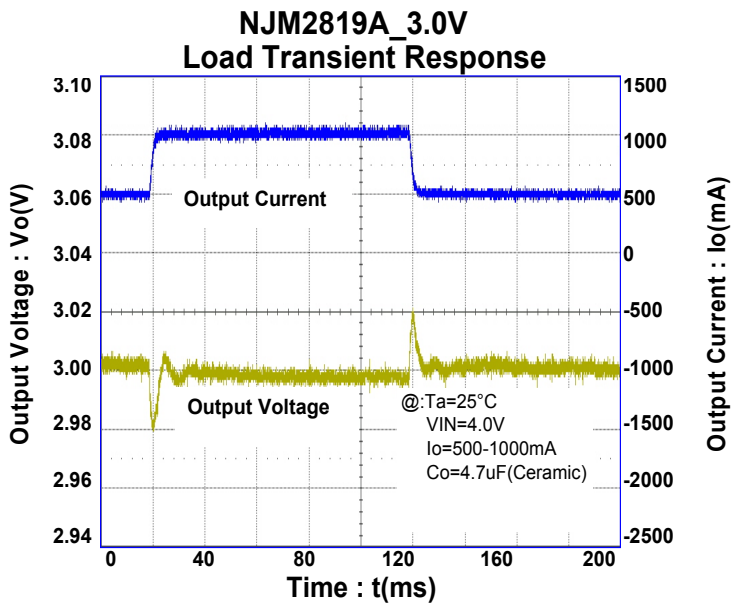
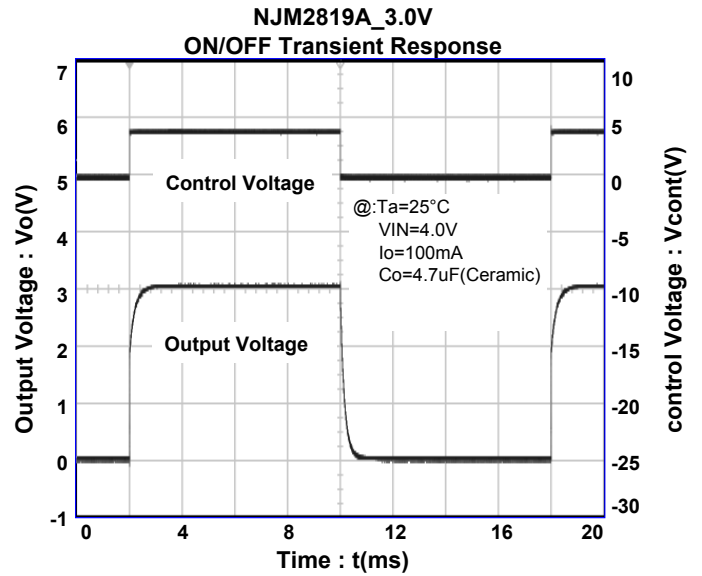
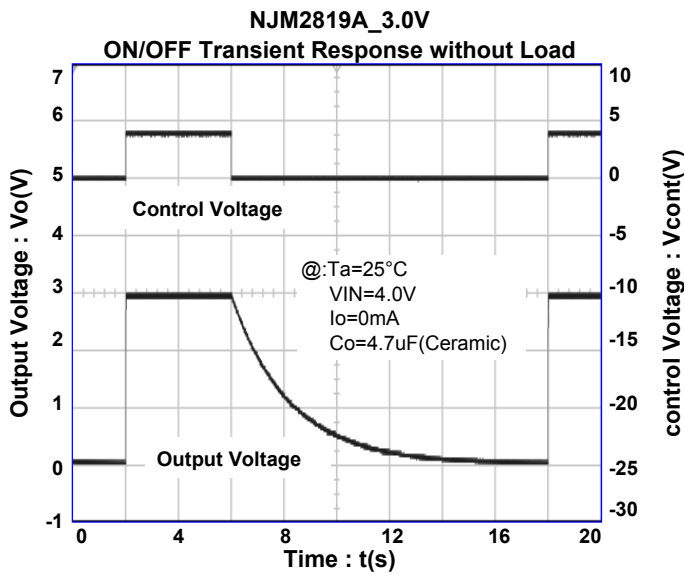

**[CAUTION]**

The specifications on this databook are only given for information, without any guarantee as regards either mistakes or omissions. The application circuits in this databook are described only to show representative usages of the product and not intended for the guarantee or permission of any right including the industrial rights.