

ADJUSTABLE HIGH PRECISION SHUNT REGULATOR

■GENERAL DESCRIPTION

The **NJM2820/ 2821/ 2822** is a 1.25V precision shunt regulator.

High precision voltage accuracy of $\pm 0.7\%$ * is realized by the total optimization from chip design to packaging. In addition, it features low cathode current of 80uA for low current operation.

It is suitable for AC-DC converter secondary circuit, reference voltage applications for A/D and D/A converters, and other applications where precision reference is required.

■FEATURES

- High Precision Voltage Reference 1.250V \pm 0.7%
- Flow Soldering*
- Minimum Input Current 80uA typ.
- Operating Voltage V_{REF} to 13V
- Adjustable Output Voltage
- Bipolar Technology
- Package Outline MTP5

■BLOCK DIAGRAM

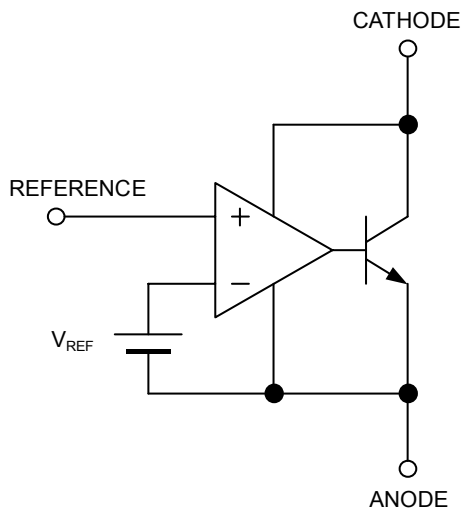

■PACKAGE OUTLINE

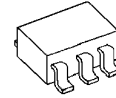

NJM2820F
NJM2821F
NJM2822F

■PIN CONFIGURATION

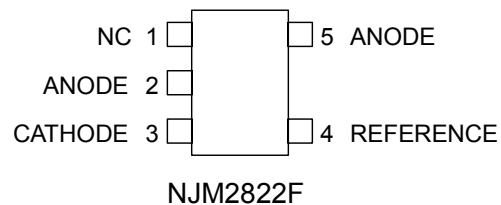
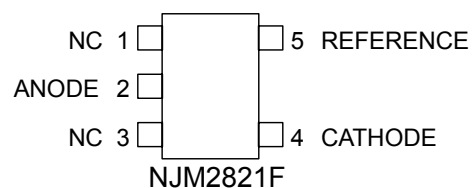
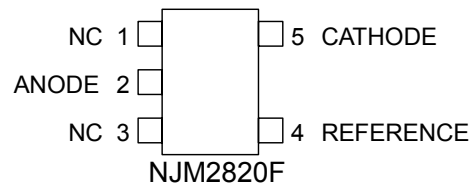

* These contents are based on the result that evaluated the arbitrary sample. The characteristic is not guaranteed. The design and reliability that fully considered flow mounting are checked but the influence by temperature profile etc. is also considered. Please consult with sales representatives for a recommendation temperature profile.

NJM2820, NJM2821, NJM2822

www.DataSheet4U.com

■ABSOLUTE MAXIMUM RATINGS (Ta=25°C)

PARAMETER	SYMBOL	MAXIMUM RATINGS	UNIT
Cathode Voltage	V_{KA}	14	V
Continuous Cathode Current	I_K	-30 ~ 50	mA
Reference Input Current	I_{REF}	-10 ~ 0.05	mA
Power Dissipation	P_D	(MTP5) 200	mW
Operating Temperature Range	T_{OPR}	-40 ~ +85	°C
Storage Temperature Range	T_{STG}	-40 ~ +150	°C

■RECOMMENDED OPERATING CONDITIONS (Ta=25°C)

PARAMETER	SYMBOL	MIN.	TYP.	MAX.	UNIT
Cathode Voltage	V_{KA}	V_{REF}	-	13	V
Cathode Current	I_K	0.5	-	30	mA

■ELECTRICAL CHARACTERISTICS ($I_K=1mA, Ta=25°C$)

PARAMETER	SYMBOL	TEST CONDITION	MIN.	TYP.	MAX.	UNIT
Reference Voltage	V_{REF}	$V_{KA}=V_{REF}$ (*1)	1241	1250	1259	mV
Reference Voltage Change vs. Cathode Voltage Change	$\frac{\Delta V_{REF}}{\Delta V_{KA}}$	$ V_{REF} \leq V_{KA} \leq 5V$ (*2)	-	-	± 2.7	mV/V
		$5V \leq V_{KA} \leq 13V$ (*2)	-	-	± 2.0	mV/V
Reference Input Current	I_{REF}	$R1=10k\Omega, R2=\infty$ (*2)	-	2.0	4.0	μA
Minimum Input Current	I_{MIN}	$V_{KA}=V_{REF}, \Delta V_{REF}=1\%$ (*1)	-	80	500	μA
Cathode Current (Off Cond.)	I_{OFF}	$V_{KA}=13V, V_{REF}=0V$ (*3)	-	0.01	1.0	μA
Dynamic Impedance	$ Z_{KA} $	$V_{KA}=V_{REF}, f \leq 1kHz$ $0.5mA \leq I_K \leq 30mA$ (*1)	-	0.12	-	Ω

■TEMPERATURE CHARACTERISTICS ($I_K=1mA, Ta=-40°C \sim 85°C$)

PARAMETER	SYMBOL	TEST CONDITION	MIN.	TYP.	MAX.	UNIT
Reference Voltage Change	ΔV_{REF}	$V_{KA}=V_{REF}$ (*1)	-	± 10	-	mV
Reference Input Current Change	ΔI_{REF}	$R1=10k\Omega, R2=\infty$ (*2)	-	0.5	-	μA

$|V_{REF}|$...Reference voltage includes error.

(*1): Test Circuit (Fig.1)

(*2): Test Circuit (Fig.2)

(*3): Test Circuit (Fig.3)

In case of NJM2822, all electrical characteristics are measured referencing to the anode terminal of PIN 5.

■TEST CIRCUIT

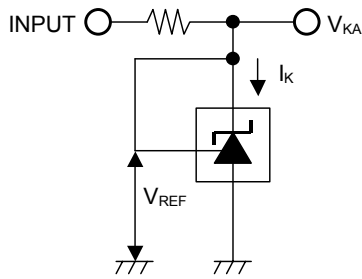

Fig.1 $V_{KA} = V_{REF}$ to test circuit

$$V_O = V_{KA} = V_{REF}$$

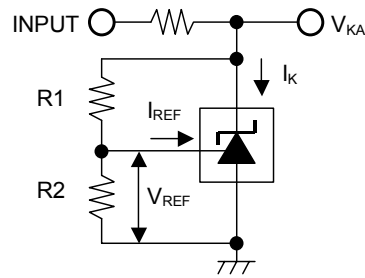

Fig.2 $V_{KA} > V_{REF}$ to test circuit

$$V_O = V_{KA} = V_{REF} \left(1 + \frac{R1}{R2} \right) + I_{REF} \times R1$$

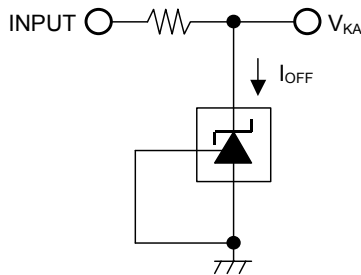

Fig.3 I_{OFF} to test circuit

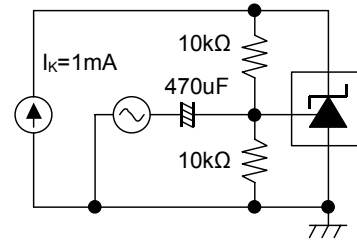
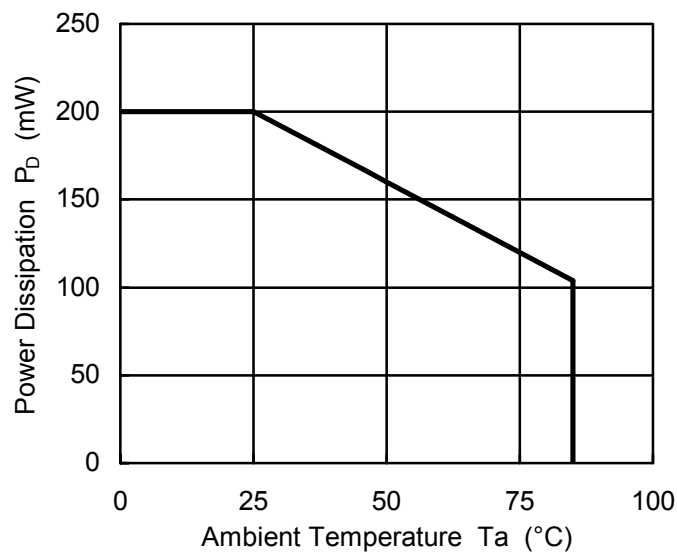

Fig.4 Gain and Phase to test circuit

■POWER DISSIPATION VS. AMBIENT TEMPERATURE



NJM2820, NJM2821, NJM2822

www.DataSheet4U.com

■ TYPICAL CHARACTERISTICS

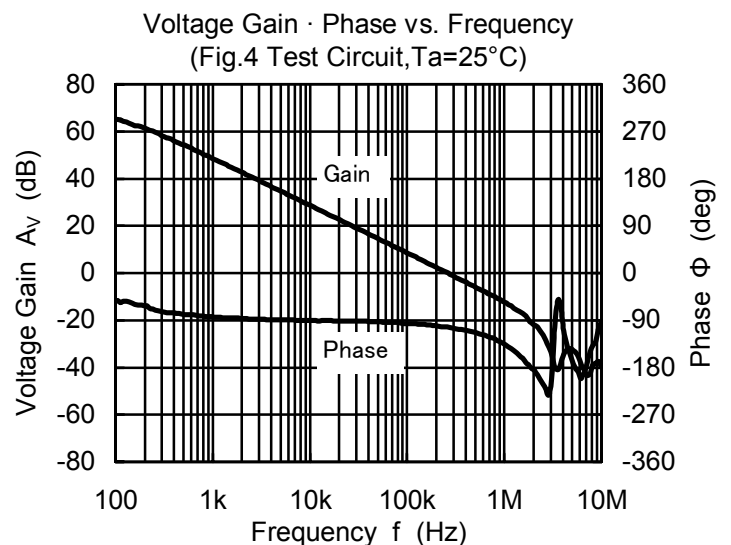
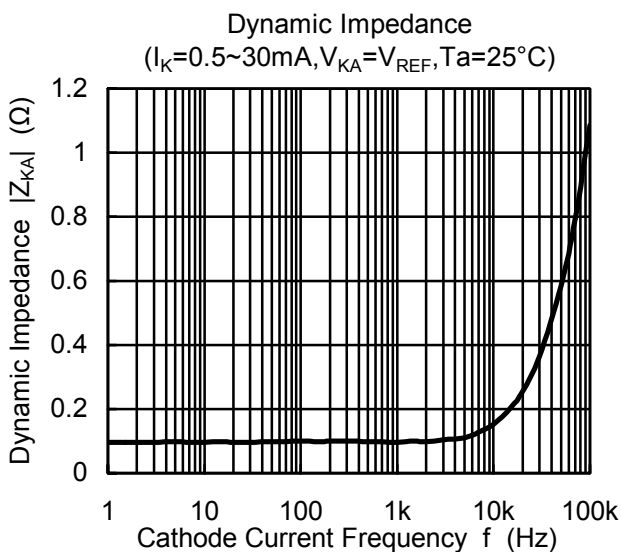
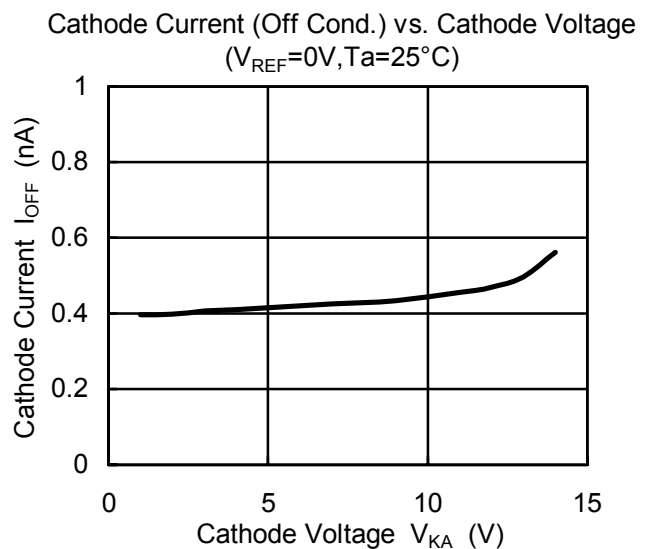
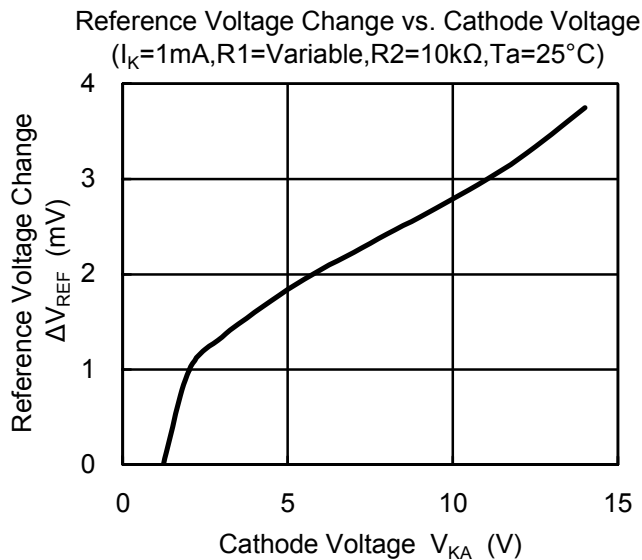
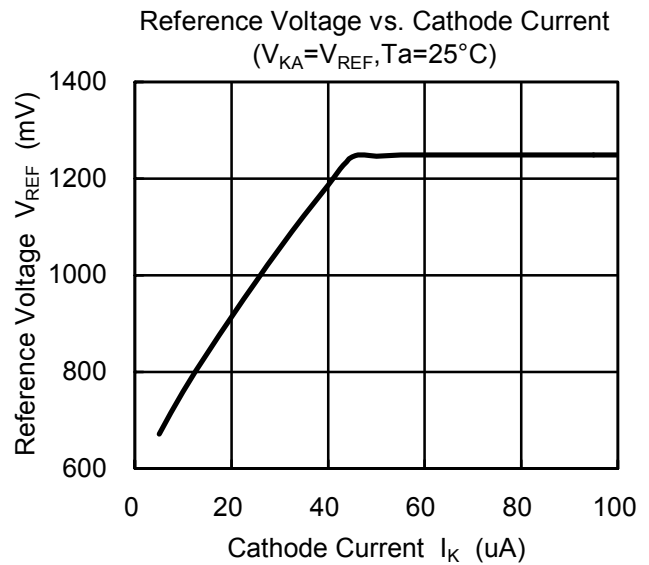
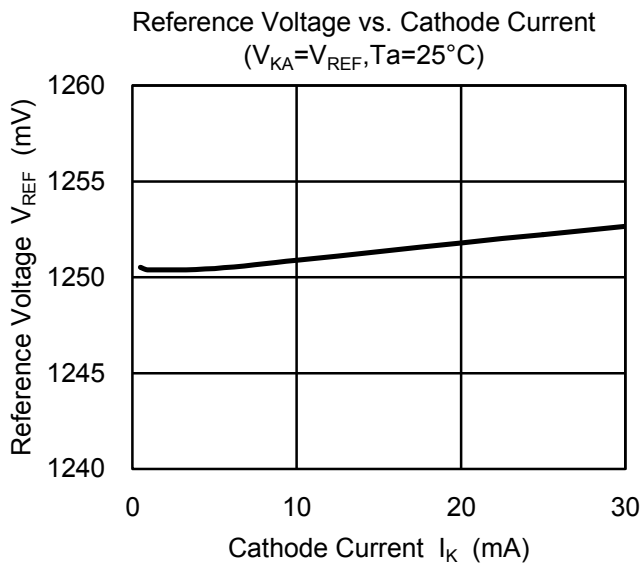

■ TYPICAL CHARACTERISTICS

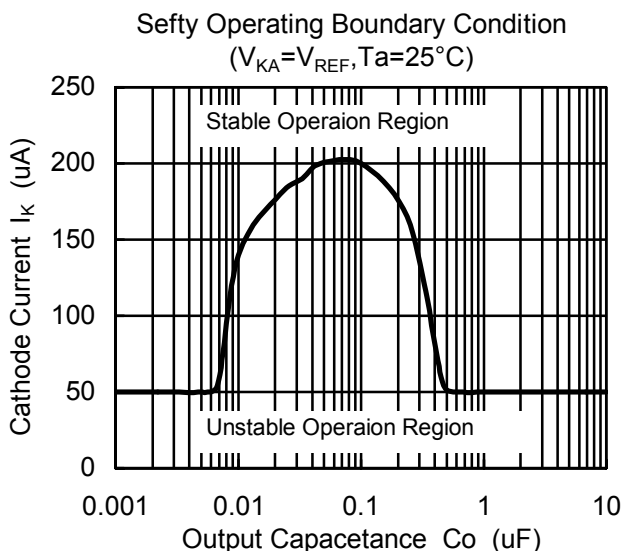

Note) Oscillation might occur while operating within the range of safety curve.

So that, it is necessary to make ample margins by taking considerations of fluctuation of the device.

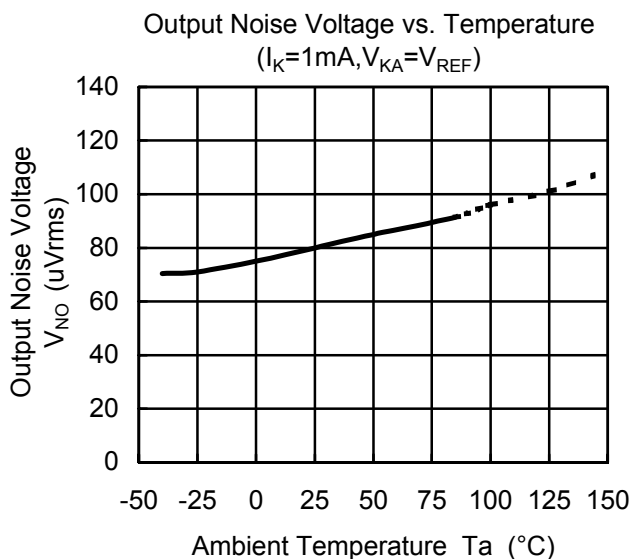
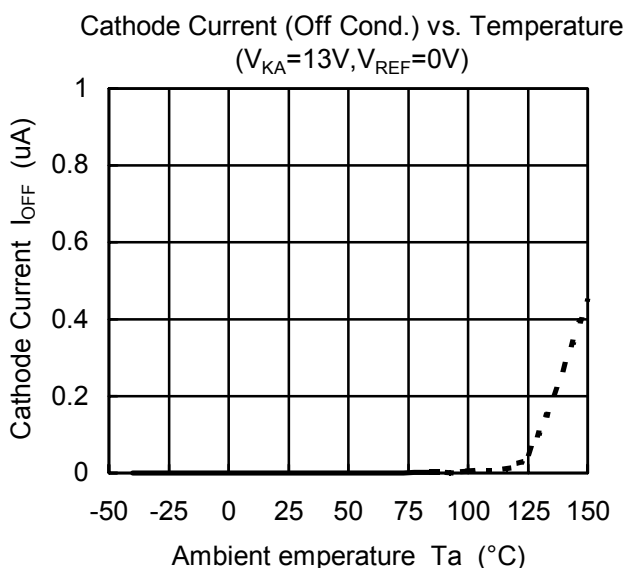
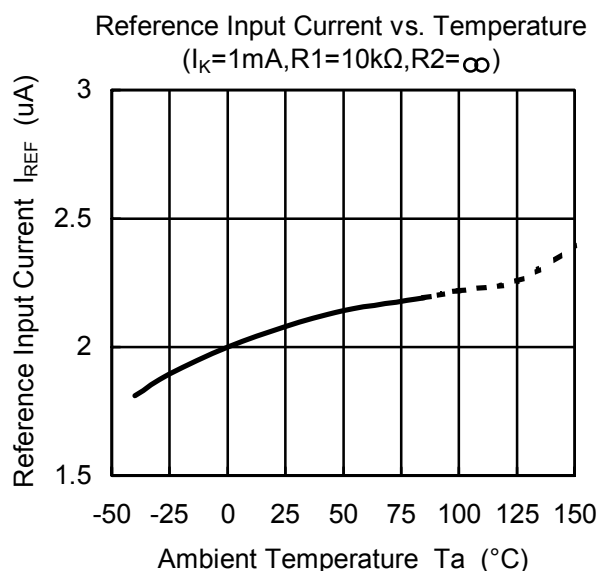
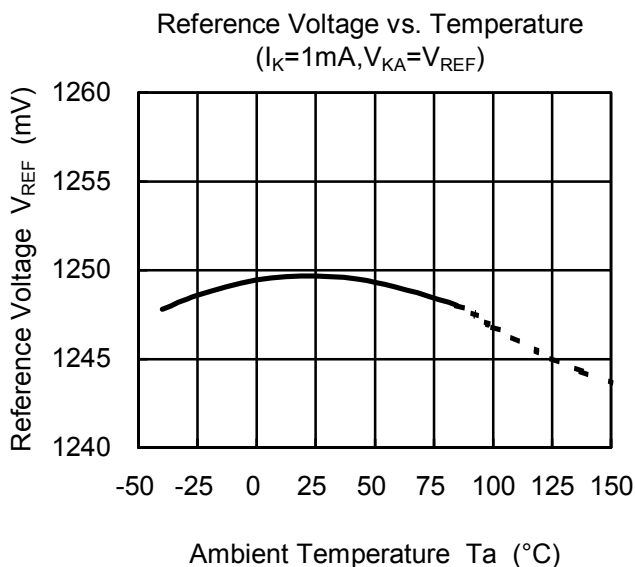

NJM2820, NJM2821, NJM2822

www.DataSheet4U.com

MEMO

[CAUTION]

The specifications on this databook are only given for information, without any guarantee as regards either mistakes or omissions. The application circuits in this databook are described only to show representative usages of the product and not intended for the guarantee or permission of any right including the industrial rights.