

## Very Low Output Voltage Series Regulator

### ■ GENERAL DESCRIPTION

The NJM2847 is a series voltage regulator that delivers up to 150mA output current with the output voltage of 0.8 to 1.4V with ON/OFF control.

Advanced Bipolar technology achieves low noise, high ripple rejection, High accuracy and low quiescent current.

Small packaging and 2.2 $\mu$ F small decoupling capacitor make the NJM2847 suitable for space conscious applications.

### ■ PACKAGE OUTLINE

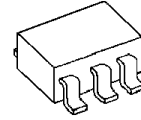

NJM2847F3

### ■ FEATURES

- Output Voltage Range 0.8V to 1.4V
- Input Voltage Range 2.3V to 9.0V
- High Ripple Rejection 85dB typ. (f=1kHz, V<sub>O</sub>=0.8V version)
- Very Low Output Noise Voltage V<sub>NO</sub>=20 $\mu$ Vrms typ. (C<sub>p</sub>=0.01 $\mu$ F)
- Output Current I<sub>O</sub>(max)=150mA
- High Precision Output V<sub>O</sub> $\pm$ 1.0%
- Output Capacitor with 2.2 $\mu$ F ceramic capacitor
- ON/OFF Control
- Built-in Thermal Overload Protection and Short Circuit Current Limit Protection
- Bipolar Technology
- Package Outline SC-88A

### ■ PIN CONNECTION

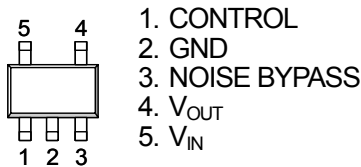

NJM2847F3

### ■ BLOCK DIAGRAM

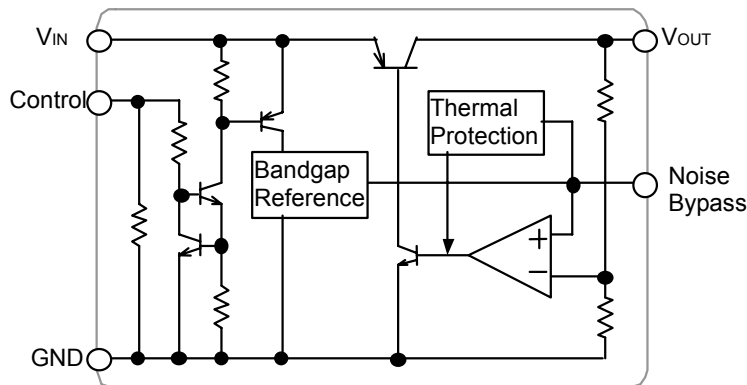

# NJM2847

## ■ OUTPUT VOLTAGE RANK LIST

The WHITE column shows applicable Voltage Rank(s).

Device Name	V <sub>out</sub>
NJM2847F3 -008	0.8V
NJM2847F3 -009	0.9V
NJM2847F3 -010	1.0V
NJM2847F3 -011	1.1V
NJM2847F3 -012	1.2V
NJM2847F3 -013	1.3V
NJM2847F3 -014	1.4V

Output Voltage Range: 0.8V to 1.4V (0.1V step)

## ■ ABSOLUTE MAXIMUM RATINGS (Ta=25°C)

PARAMETER	SYMBOL	RATINGS	UNIT
Input Voltage	V <sub>IN</sub>	+10	V
Control Voltage	V <sub>CONT</sub>	+10	V
Power Dissipation	P <sub>D</sub>	250(*1)	mW
Operating Temperature	T <sub>opr</sub>	-40 ~ +85	°C
Storage Temperature	T <sub>stg</sub>	-40 ~ +125	°C

Note1: Mounted on glass epoxy board. (76.2 × 114.3 × 1.6mm:based on EIA/JDEC standard, 2Layers)

## ■ INPUT VOLTAGE RANGE

V<sub>IN</sub>=+2.3 ~ +9V

## ■ ELECTRICAL CHARACTERISTICS (V<sub>IN</sub>=2.5V, C<sub>IN</sub>=0.1μF, C<sub>o</sub>=2.2μF, C<sub>p</sub>=0.01μF, Ta=25°C)

PARAMETER	SYMBOL	TEST CONDITION	MIN.	TYP.	MAX.	UNIT
Output Voltage	V <sub>o</sub>	I <sub>o</sub> =30mA	-1.0%	—	+1.0%	V
Input Voltage	V <sub>IN</sub>		2.3	—	9	V
Quiescent Current	I <sub>Q</sub>	I <sub>o</sub> =0mA, except I <sub>cont</sub>	—	140	200	μA
Quiescent Current at Control OFF	I <sub>Q(OFF)</sub>	V <sub>CONT</sub> =0V	—	—	100	nA
Output Current	I <sub>o</sub>	V <sub>o</sub> × 0.9V	150	200	—	mA
Line Regulation	ΔV <sub>o</sub> /ΔV <sub>IN</sub>	V <sub>IN</sub> =2.5V to 9.0V, I <sub>o</sub> =30mA	—	—	0.10	%/V
Load Regulation	ΔV <sub>o</sub> /ΔI <sub>o</sub>	I <sub>o</sub> =0mA to 100mA	—	—	0.03	%/mA
Ripple Rejection	RR	e <sub>in</sub> =200mVrms, f=1kHz, I <sub>o</sub> =10mA, V <sub>o</sub> =0.8V version	—	85	—	dB
Average Temperature Coefficient of Output Voltage	ΔV <sub>o</sub> /ΔTa	Ta=0°C to +85°C, I <sub>o</sub> =10mA	—	± 50	—	ppm/°C
Output Noise Voltage	V <sub>NO</sub>	f=10Hz to 80kHz, I <sub>o</sub> =10mA, V <sub>o</sub> =0.8V version	—	20	—	μVrms
Control Current	I <sub>CONT</sub>	V <sub>CONT</sub> =1.6V	—	3	12	μA
Control Current for ON-state	V <sub>CONT(ON)</sub>		1.6	—	—	V
Control Current for OFF-state	V <sub>CONT(OFF)</sub>		—	—	0.6	V

The above specification is a common specification for all output voltages.

Therefore, it may be different from the individual specification for a specific output voltage.

## ■ TEST CIRCUIT

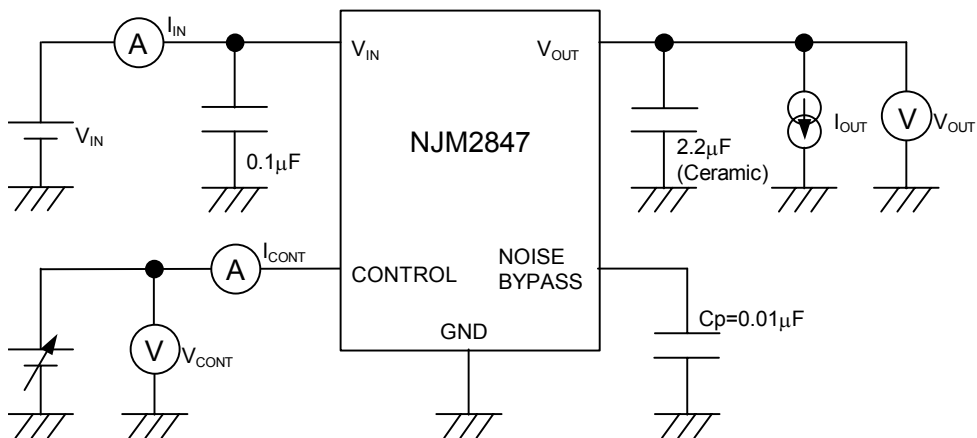

## ■ TYPICAL APPLICATION

a) In case of where ON/OFF control is not required:

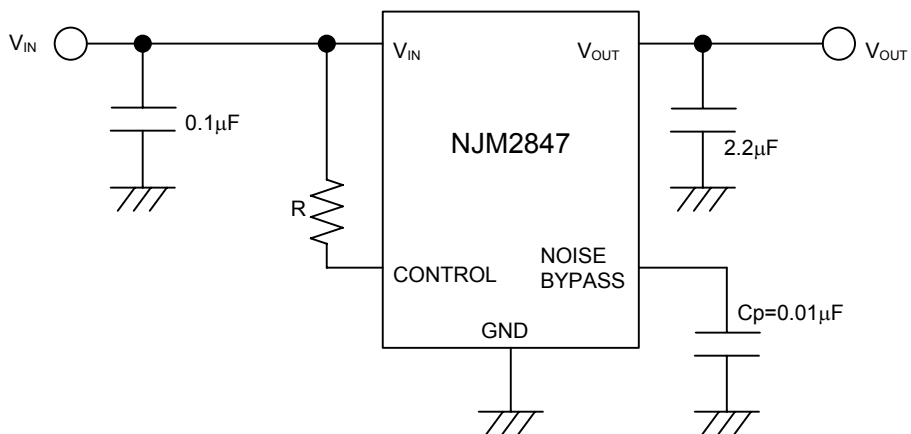

You shall connect control terminal to  $V_{IN}$  terminal.

Though the  $I_{CONT}$  decreases by inserting "R" to between Control terminal and  $V_{BIAS}$  terminal, the minimum operating voltage is increased due to the resistor "R".

# NJM2847

b) In use of ON/OFF control:

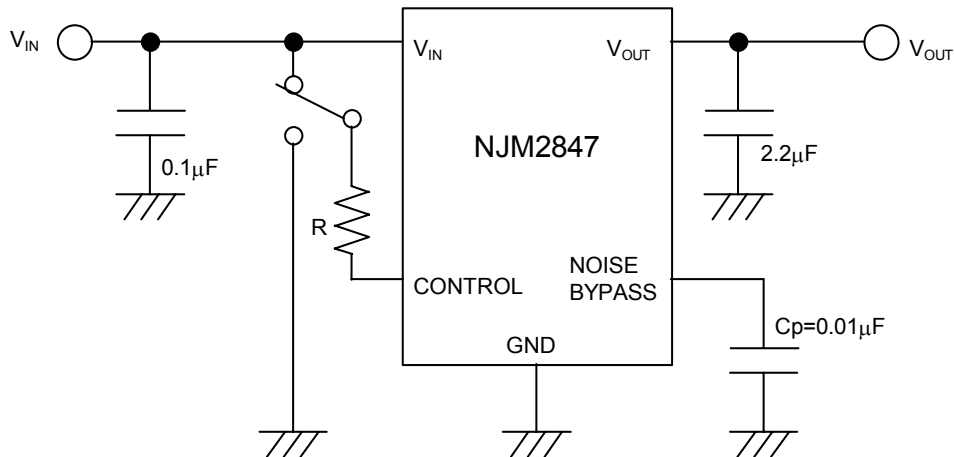

State of control terminal:

- “H”→ output is enabled.
- “L” or “open” → output is disabled.

\*In the case of using a resistance "R" between  $V_{IN}$  and control.

If this resistor is inserted, it can reduce the control current when the control voltage is high.

The applied voltage to control terminal should set to consider voltage drop through the resistor "R" and the minimum control voltage for ON-state.

The  $V_{CONT(ON)}$  and  $I_{CONT}$  have temperature dependence as shown in the "Control Current vs. Temperature" and "Control Voltage vs. Temperature" characteristics. Therefore, the resistance "R" should be selected to consider the temperature characteristics.

## \*Noise bypass Capacitor $C_p$

Noise bypass capacitor  $C_p$  reduces noise generated by band-gap reference circuit. Noise level and ripple rejection will be improved when larger  $C_p$  is used. Use of smaller  $C_p$  value may cause oscillation.

Use the  $C_p$  recommended value larger (refer to conditions of ELECTRIC CHARACTERISTIC) to avoid the problem.

## \*Input Capacitor $C_{IN}$

Input Capacitor  $C_{IN}$  is required to prevent oscillation and reduce power supply ripple for applications when high power supply impedance or a long power supply line.

Therefore, use the recommended  $C_{IN}$  value (refer to conditions of ELECTRIC CHARACTERISTIC) or larger and should connect between GND and  $V_{IN}$  as shortest path as possible to avoid the problem.

## \*Output Capacitor $C_O$

Output capacitor ( $C_O$ ) will be required for a phase compensation of the internal error amplifier.

The capacitance and the equivalent series resistance (ESR) influence to stable operation of the regulator.

Use of a smaller  $C_O$  may cause excess output noise or oscillation of the regulator due to lack of the phase compensation.

On the other hand, Use of a larger  $C_O$  reduces output noise and ripple output, and also improves output transient response when rapid load change.

Therefore, use the recommended  $C_O$  value (refer to conditions of ELECTRIC CHARACTERISTIC) or larger and should connect between GND and  $V_{OUT}$  as shortest path as possible for stable operation

In addition, you should consider varied characteristics of capacitor (a frequency characteristic, a temperature characteristic, a DC bias characteristic and so on) and unevenness peculiar to a capacitor supplier enough.

When selecting  $C_O$ , recommend that have withstand voltage margin against output voltage and superior temperature characteristic though this product is designed stability works with wide range ESR of capacitor including low ESR products.

# NJM2847

## POWER DISSIPATION vs. AMBIENT TEMPERATURE(SC-88A)

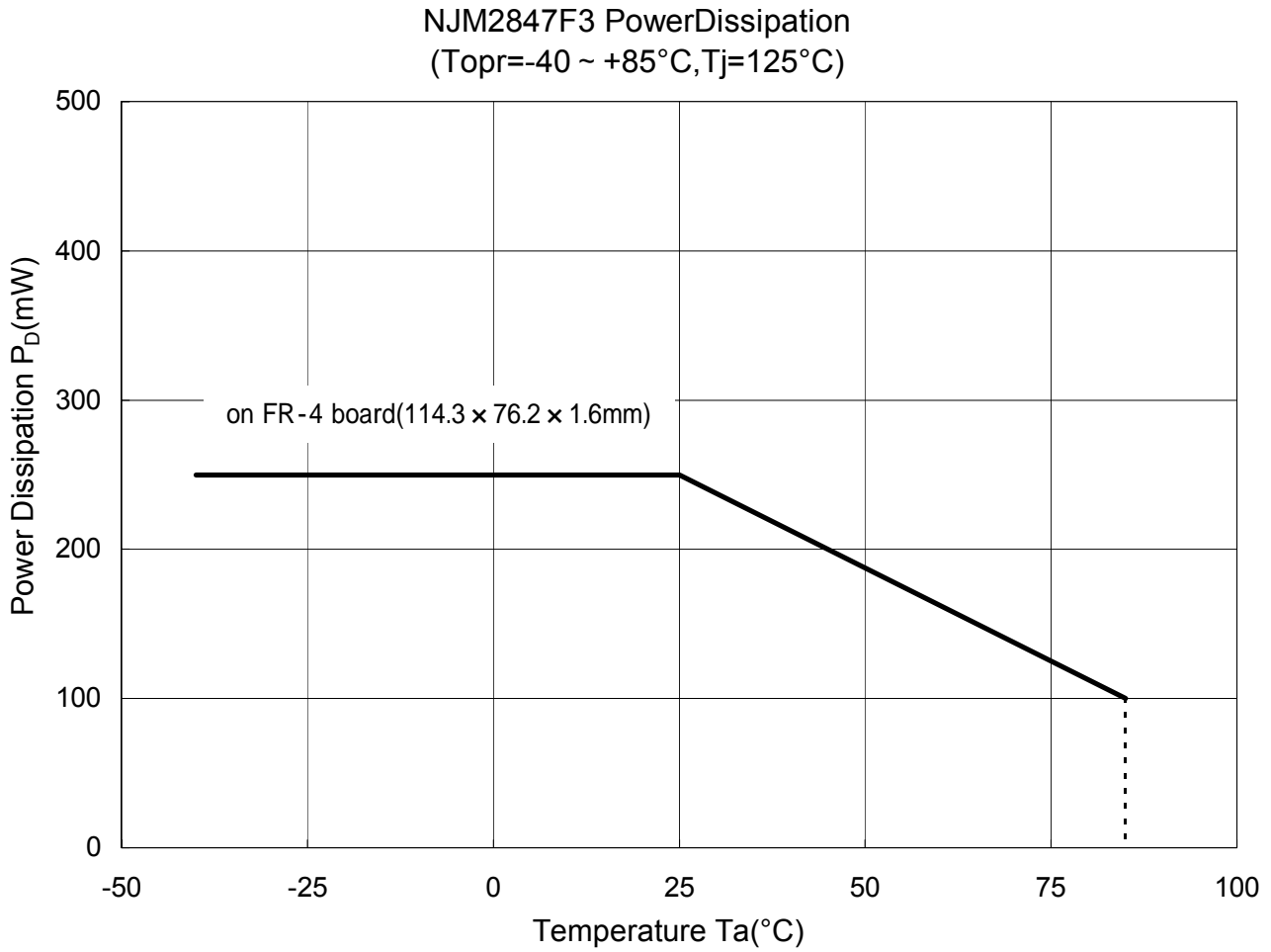

## Typical Characteristics

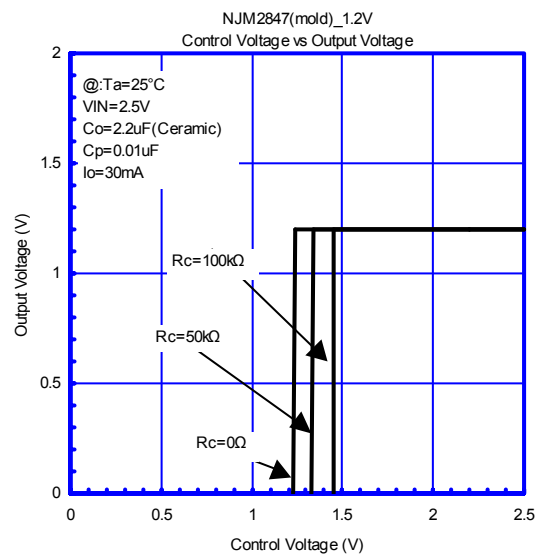
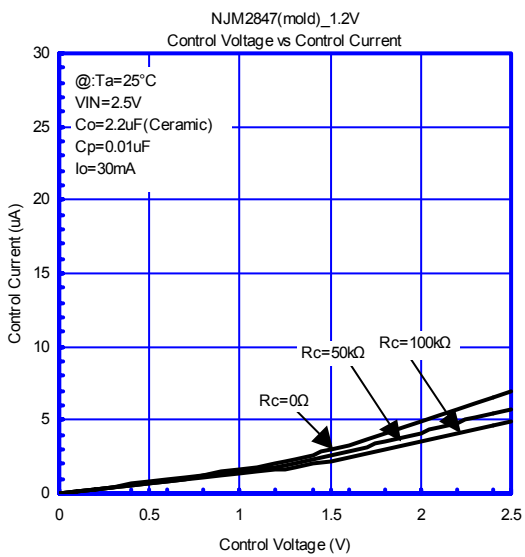
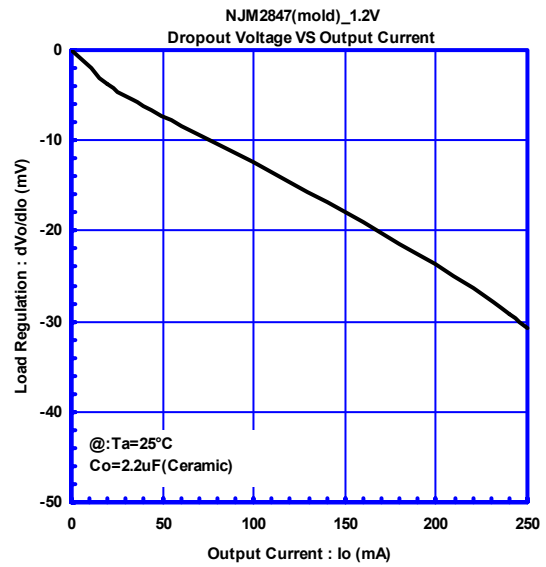
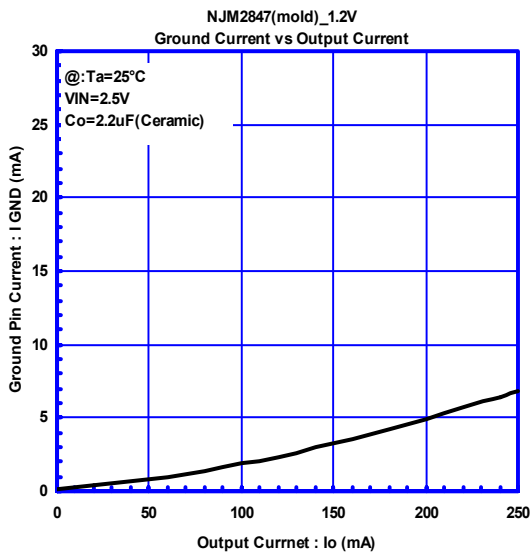
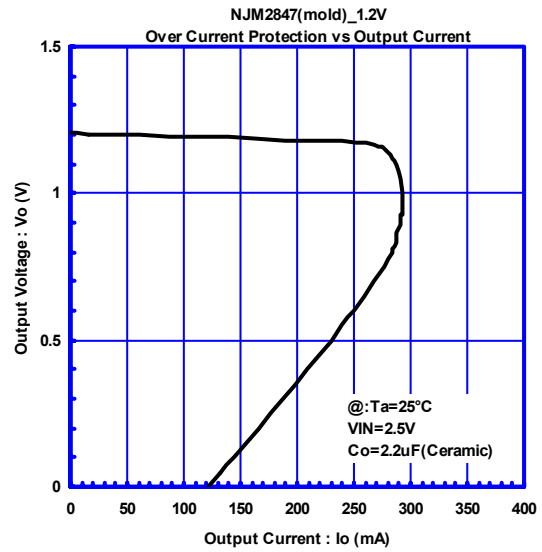
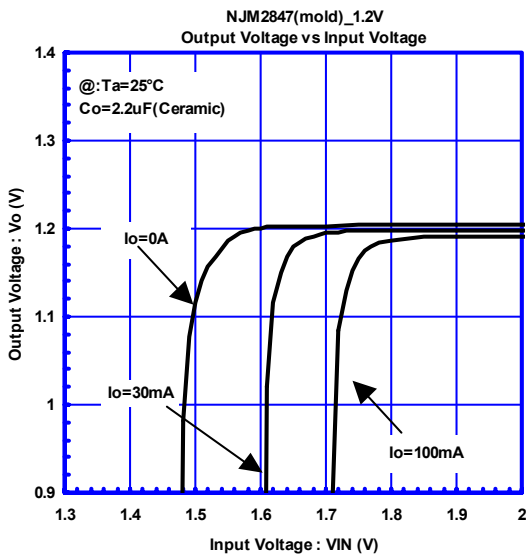

# NJM2847

## Typical Characteristics

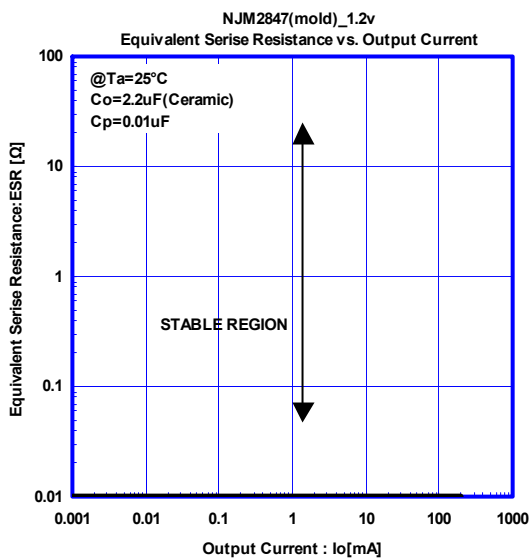
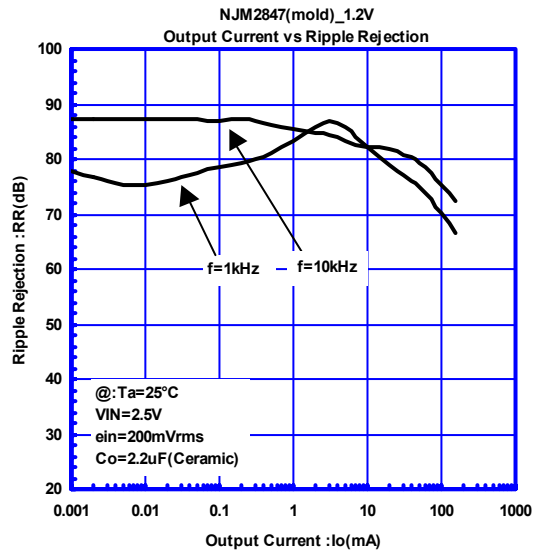
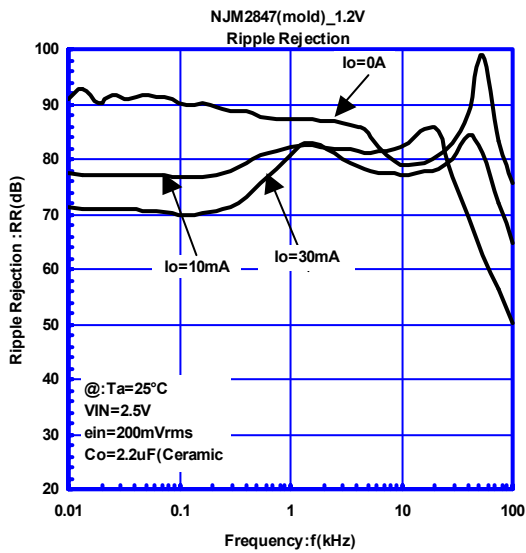
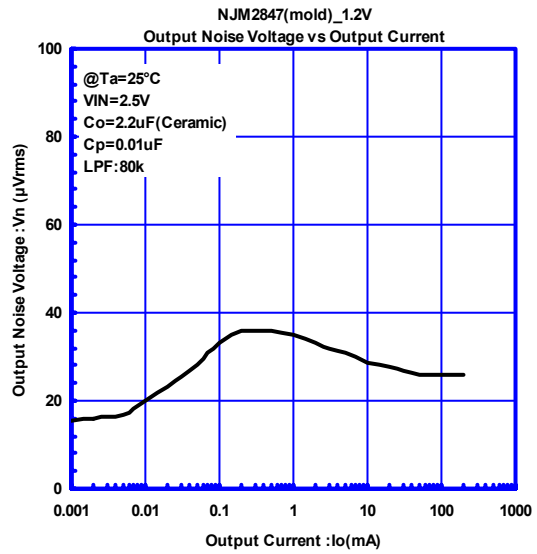
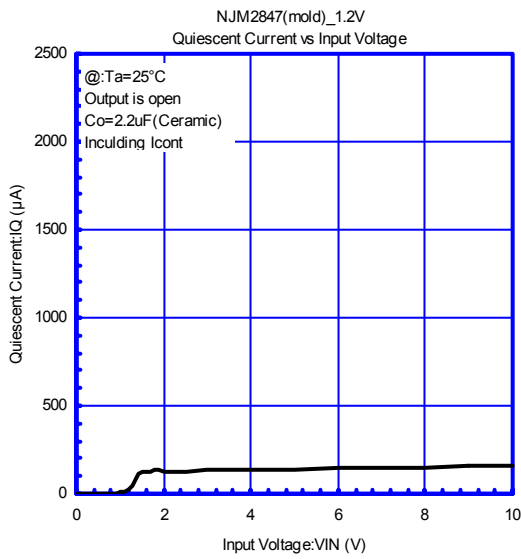



## Typical Characteristics

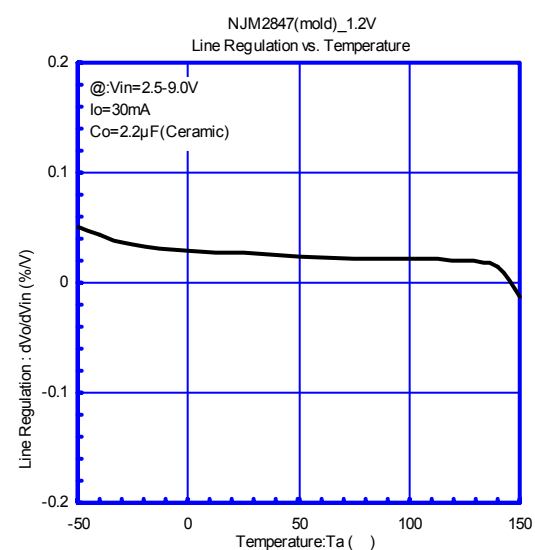
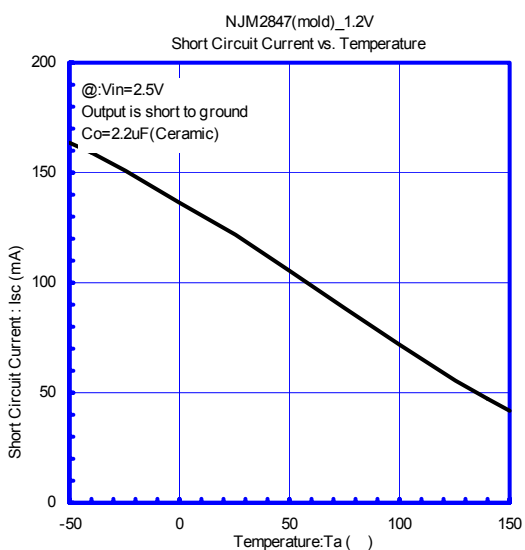
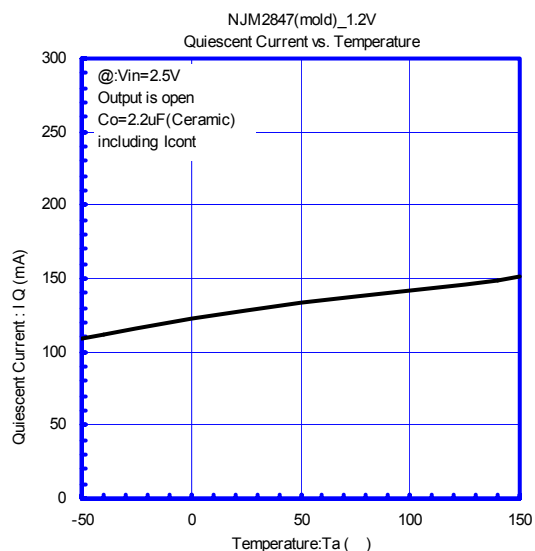
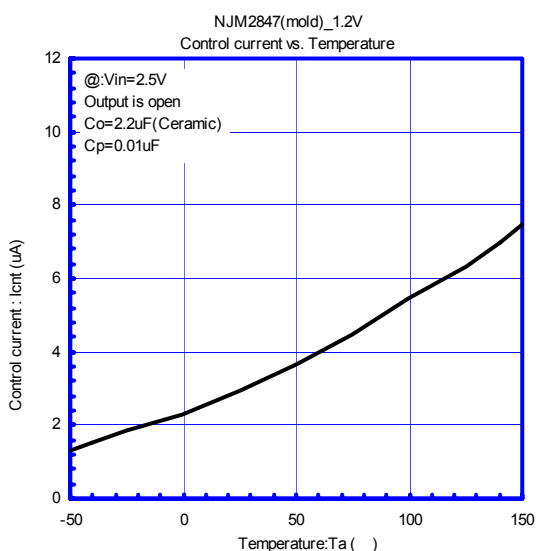
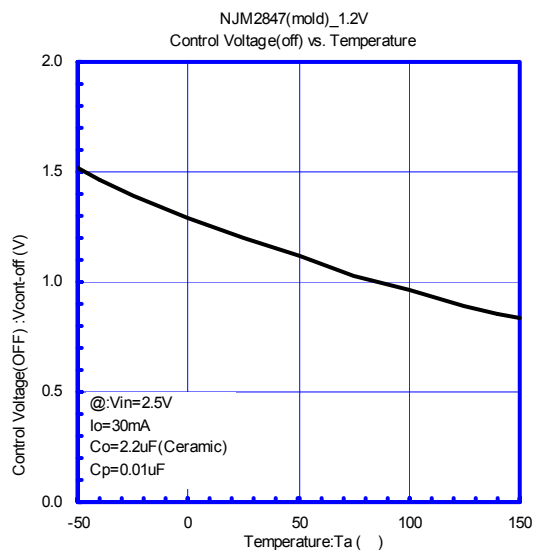
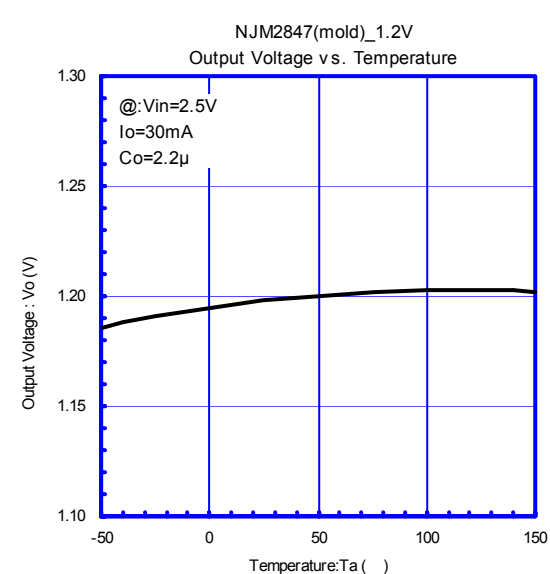

# NJM2847

## ■ Typical Characteristics

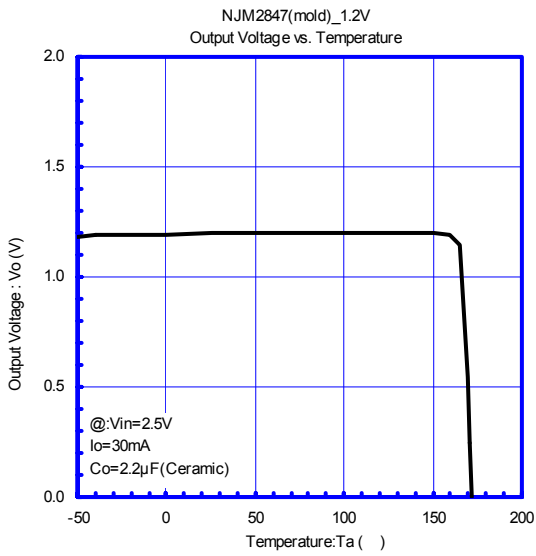
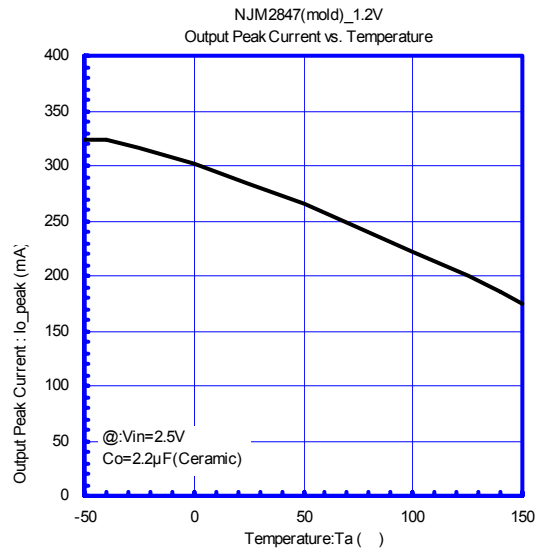
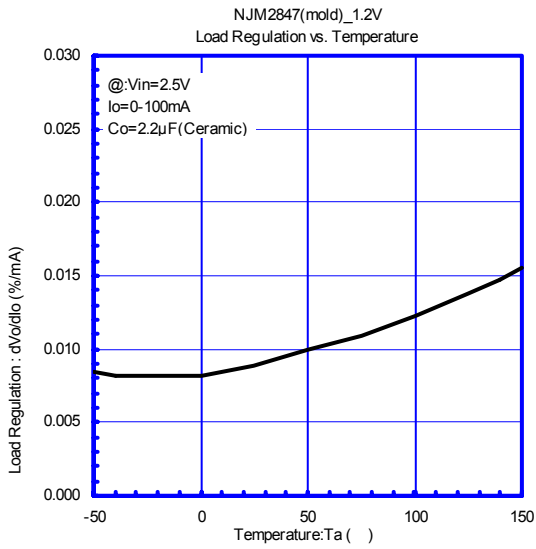

## Typical Characteristics

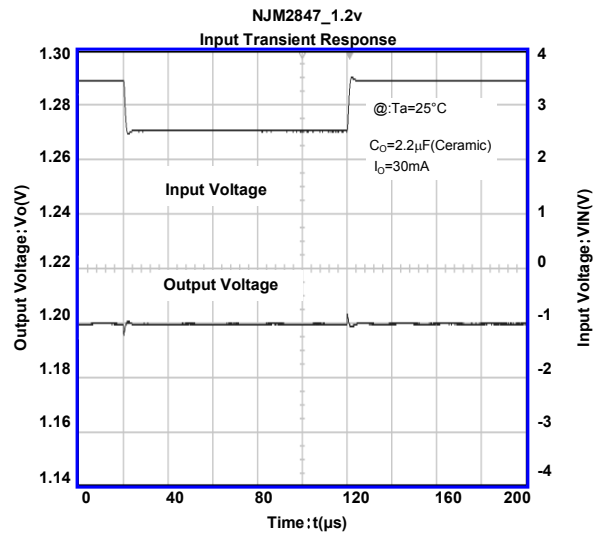
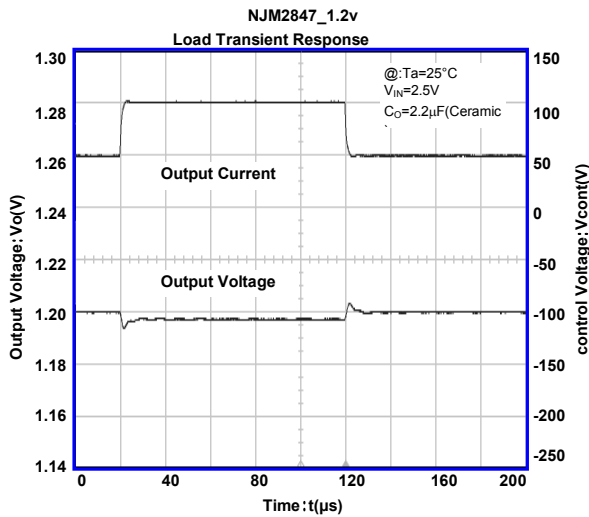
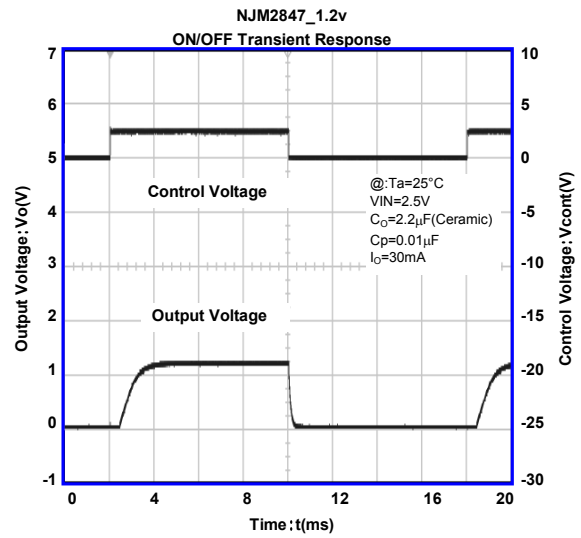
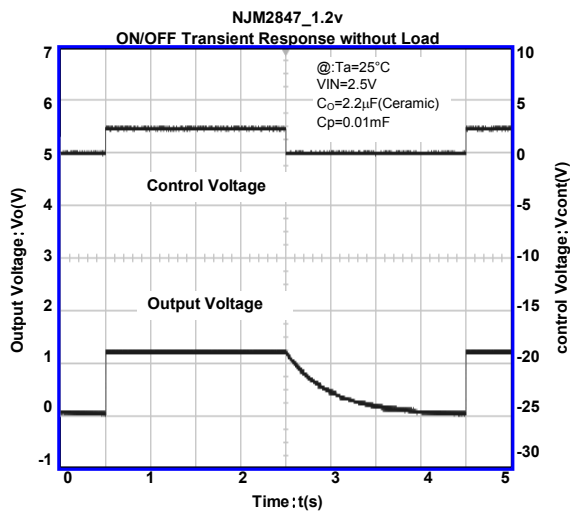

**[CAUTION]**

The specifications on this databook are only given for information, without any guarantee as regards either mistakes or omissions. The application circuits in this databook are described only to show representative usages of the product and not intended for the guarantee or permission of any right including the industrial rights.