

Low Dropout Voltage Regulator

■ GENERAL DESCRIPTION

The NJM2877 is a 150mA output low dropout voltage regulator with ON/OFF control.

Advanced Bipolar technology achieves low noise, high ripple rejection, High accuracy and low quiescent current.

Small packaging and 0.47 μ F small decoupling capacitor make the NJM2877 suitable for space conscious applications.

■ PACKAGE OUTLINE

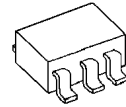

NJM2877F3

■ FEATURES

- High Ripple Rejection 75dB typ. (f=1kHz Vo=3V version)
- Output Noise Voltage Vno=30 μ Vrms typ. (Cp=0.01 μ F)
- Output Current Io(max.)=150mA
- High Precision Output Vo \pm 1.0%
- Output capacitor with 0.47 μ F ceramic capacitor(Vo \geq 2.7V Version)
- Low Dropout Voltage 0.10V typ. (Io=60mA)
- ON/OFF Control (Active High)
- Internal Thermal Overload Protection
- Internal Short Circuit Current Limit
- Bipolar Technology
- Package Outline SC-88A

■ PIN CONFIGURATION

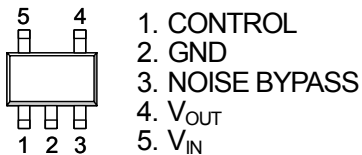

NJM2877F3

■ EQUIVALENT CIRCUIT

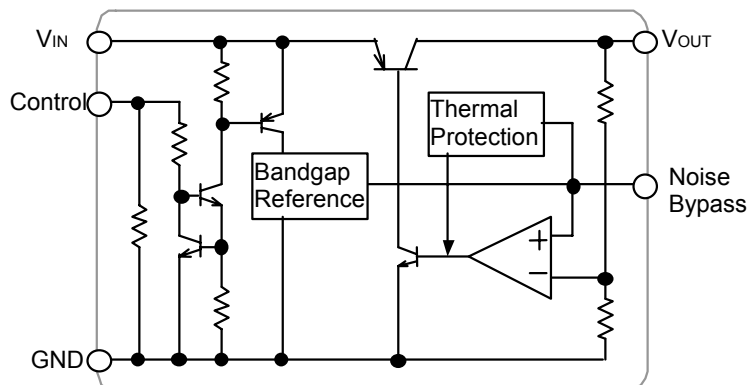

NJM2877

www.DataSheet4U.com

■ OUTPUT VOLTAGE RANK LIST

Device Name	V _{OUT}	Device Name	V _{OUT}	Device Name	V _{OUT}
NJM2877F3 -15	1.5V	NJM2877F3 -28	2.8V	NJM2877F3 -355	3.55V
NJM2877F3 -18	1.8V	NJM2877F3 -285	2.85V	NJM2877F3 -36	3.6V
NJM2877F3 -21	2.1V	NJM2877F3 -29	2.9V	NJM2877F3 -04	4.0V
NJM2877F3 -22	2.2V	NJM2877F3 -03	3.0V	NJM2877F3 -42	4.2V
NJM2877F3 -23	2.3V	NJM2877F3 -31	3.1V	NJM2877F3 -45	4.5V
NJM2877F3 -24	2.4V	NJM2877F3 -32	3.2V	NJM2877F3 -46	4.6V
NJM2877F3 -25	2.5V	NJM2877F3 -33	3.3V	NJM2877F3 -48	4.8V
NJM2877F3 -255	2.55V	NJM2877F3 -345	3.45V	NJM2877F3 -05	5.0V

Output voltage options available : 1.5 ~ 5.0V (0.1V step)

■ ABSOLUTE MAXIMUM RATINGS

(Ta=25°C)

PARAMETER	SYMBOL	RATINGS	UNIT
Input Voltage	V _{IN}	+10	V
Control Voltage	V _{CONT}	+10(*1)	V
Power Dissipation	P _D	250(*2)	mW
Operating Temperature	T _{opr}	-40 ~ +85	°C
Storage Temperature	T _{stg}	-40 ~ +125	°C

(*1) : When input voltage is less than +10V, the absolute maximum control voltage is equal to the input voltage.

(*2) : Mounted on glass epoxy board based on EIA/JEDEC. (114.3x76.2x1.6mm: 2Layers)

■ Operating voltage

V_{IN}=+2.3 ~ +9V (In case of Vo<2.1V version)

■ ELECTRICAL CHARACTERISTICS

(V_{IN}=Vo+1V, C_{IN}=0.1μF, Co=0.47μF: Vo≥2.7V (Co=1.0μF : 1.8V<Vo≤2.6V, Co=2.2μF : Vo≤1.8V), Cp=0.01μF, Ta=25°C)

PARAMETER	SYMBOL	TEST CONDITION	MIN.	TYP.	MAX.	UNIT
Output Voltage	Vo	Io=30mA	-1.0%	-	+1.0%	V
Input Voltage	V _{IN}		-	-	9	V
Quiescent Current	I _Q	Io=0mA, except I _{cont}	-	120	180	μA
Quiescent Current at Control OFF	I _{Q(OFF)}	V _{CONT} =0V	-	-	100	nA
Output Current	Io	Vo - 0.3V	150	200	-	mA
Line Regulation	ΔVo/ΔV _{IN}	V _{IN} =Vo+1V ~ Vo+6V, Io=30mA	-	-	0.10	%/V
Load Regulation	ΔVo/ΔIo	Io=0 ~ 100mA	-	-	0.03	%/mA
Dropout Voltage (*3)	ΔV _{L.O}	Io=60mA	-	0.10	0.18	V
Ripple Rejection	RR	e _{in} =200mVrms, f=1kHz, Io=10mA, Vo=3V version	-	75	-	dB
Average Temperature Coefficient of Output Voltage	ΔVo/ΔTa	Ta=0 ~ +85°C, Io=10mA	-	± 50	-	ppm/°C
Output Noise Voltage	V _{NO}	f=10Hz-80kHz, Io=10mA, Vo=3V Version	-	30	-	μVrms
Control Current	I _{CONT}	V _{CONT} =1.6V	-	3	12	μA
Control Voltage for ON-state	V _{CONT(ON)}		1.6	-	-	V
Control Voltage for OFF-state	V _{CONT(OFF)}		-	-	0.6	V

(*3): The output voltage excludes under 2.1V.

The above specification is a common specification for all output voltages.

Therefore, it may be different from the individual specification for a specific output voltage.

■ TEST CIRCUIT

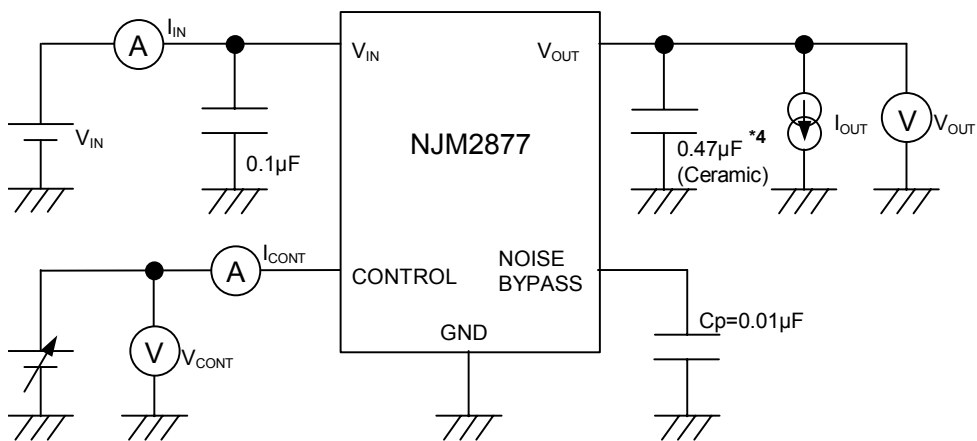

*4: 1.8V < V_O ≤ 2.6V version: C_O = 1.0µF (Ceramic)
 V_O ≤ 1.8V version: C_O = 2.2µF (Ceramic)

■ TYPICAL APPLICATION

① In the case where ON/OFF Control is not required:

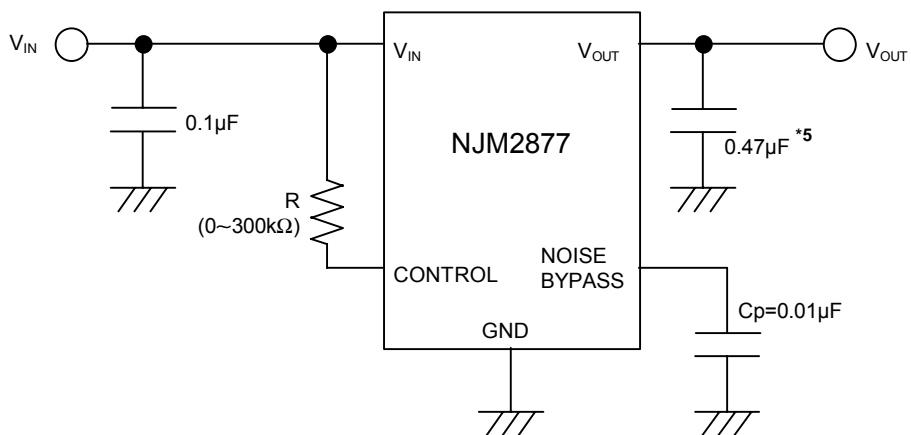

*5: 1.8V < V_O ≤ 2.6V version: C_O = 1.0µF
 V_O ≤ 1.8V version: C_O = 2.2µF

Connect control terminal to V_{IN} terminal

② In use of ON/OFF CONTROL:

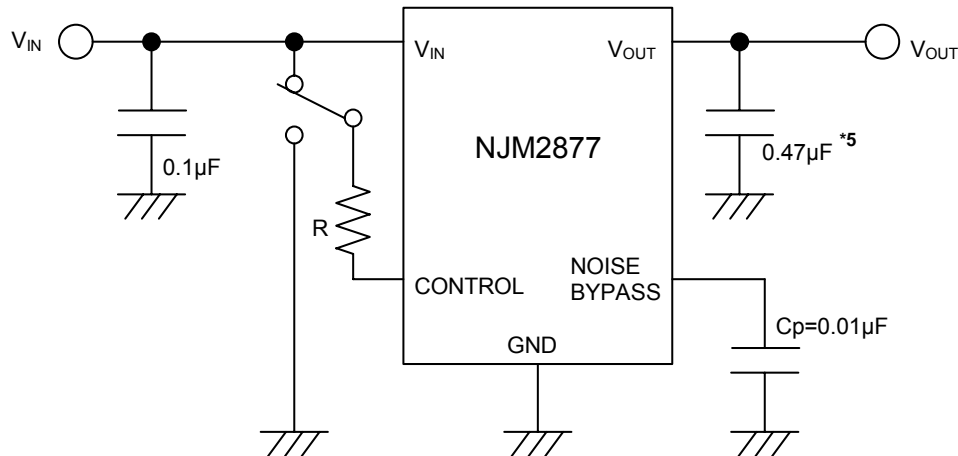

*5 : 1.8V < V_o ≤ 2.6V version : $C_o = 1.0\mu\text{F}$
 $V_o \leq 1.8\text{V}$ version : $C_o = 2.2\mu\text{F}$

State of control terminal:

- "H" → output is enabled.
- "L" or "open" → output is disabled.

***Noise bypass Capacitance C_p**

Noise bypass capacitance C_p reduces noise generated by band-gap reference circuit. Noise level and ripple rejection will be improved when larger C_p is used. Use of smaller C_p value may cause oscillation. Use the C_p value of $0.01\mu\text{F}$ greater to avoid the problem.

***Input Capacitance C_{IN}**

Input Capacitance C_{IN} is required to prevent oscillation and reduce power supply ripple for applications with high power supply impedance or a long power supply line. Use the C_{IN} value of $0.1\mu\text{F}$ greater to avoid the problem. C_{IN} should connect between GND and V_{IN} as short as possible.

***In the case of using a resistance "R" between V_{IN} and control.**

The current flow into the control terminal while the IC is ON state (I_{CONT}) can be reduced when a pull up resistance "R" is inserted between V_{IN} and the control terminal. The minimum control voltage for ON state ($V_{CONT(ON)}$) is increased due to the voltage drop caused by I_{CONT} and the resistance "R". The I_{CONT} is temperature dependence as shown in the "Control Current vs. Temperature" characteristics. Therefore, the resistance "R" should be carefully selected to ensure the control voltage exceeds the $V_{CONT(ON)}$ over the required temperature range.

■ POWER DISSIPATION vs. AMBIENT TEMPERATURE (SC-88A)

NJM2877F3 Power Dissipation
($T_{opr} = -40 \sim +85^{\circ}\text{C}$, $T_j = 125^{\circ}\text{C}$)

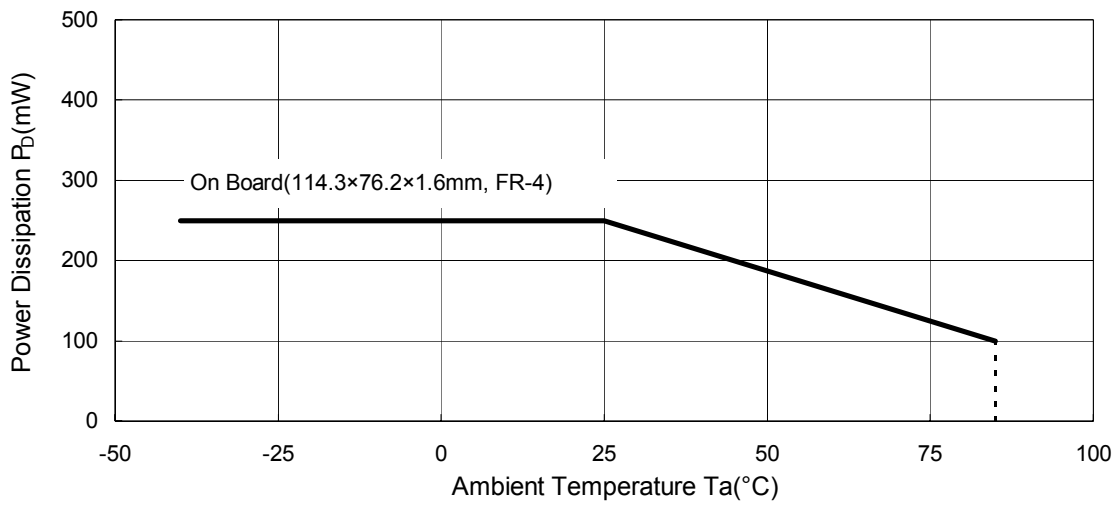

NJM2877

TYPICAL CHARACTERISTICS

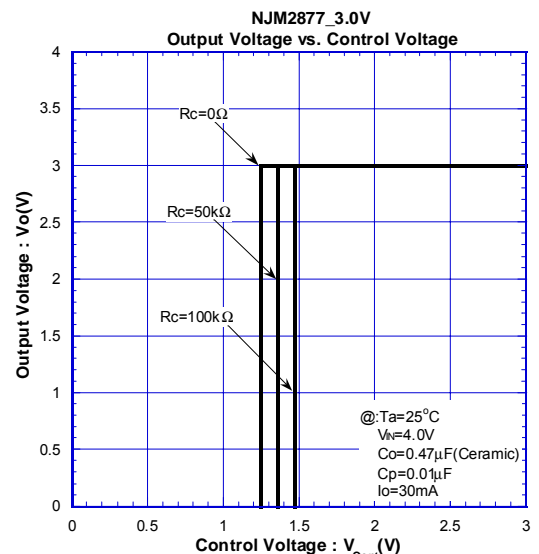
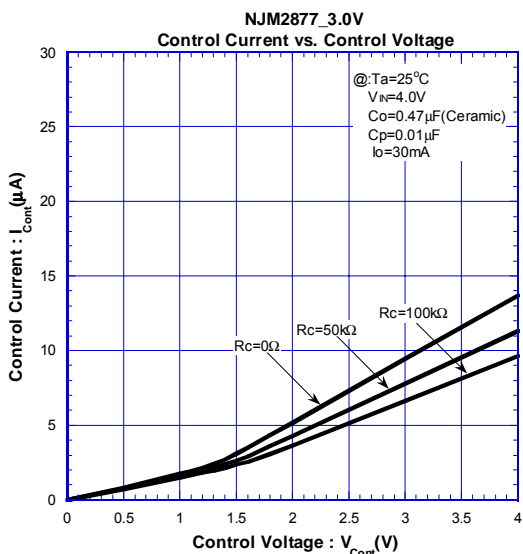
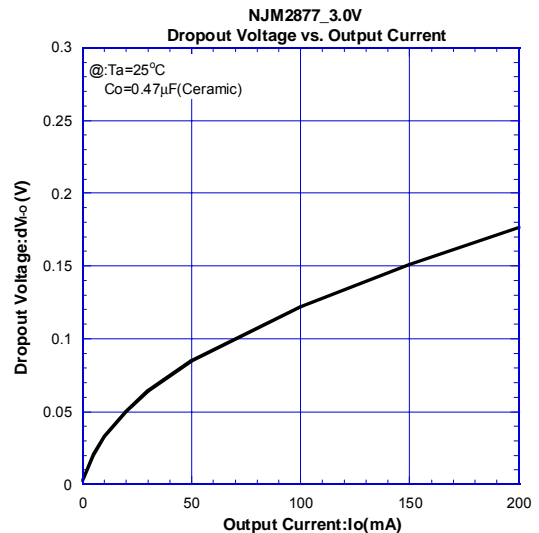
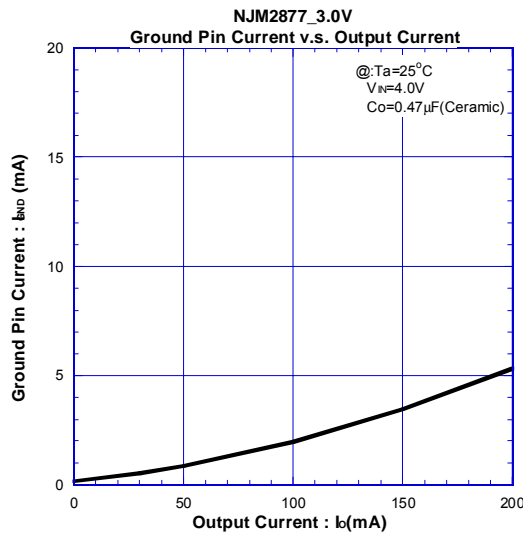
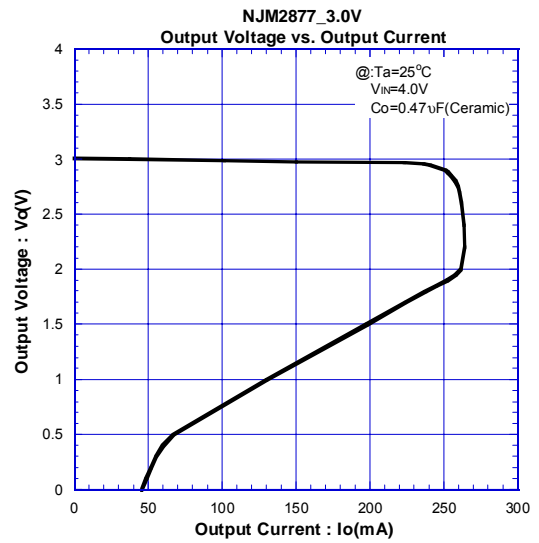
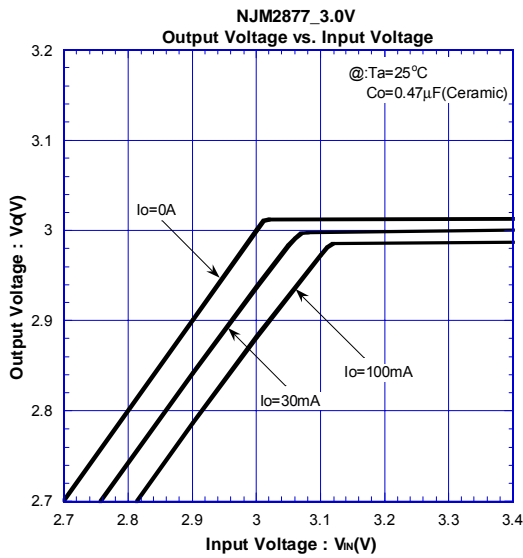

■ TYPICAL CHARACTERISTICS

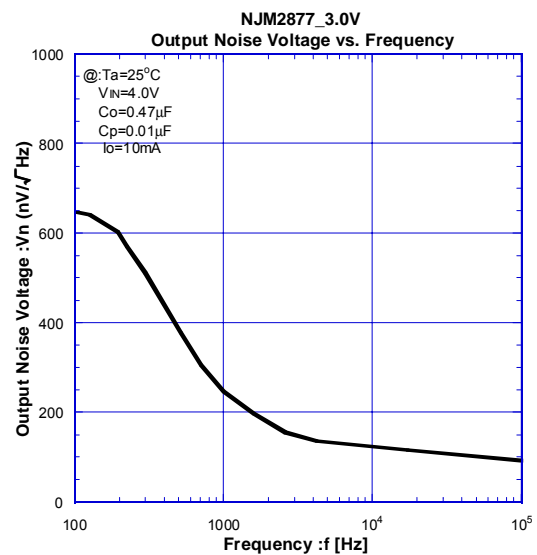
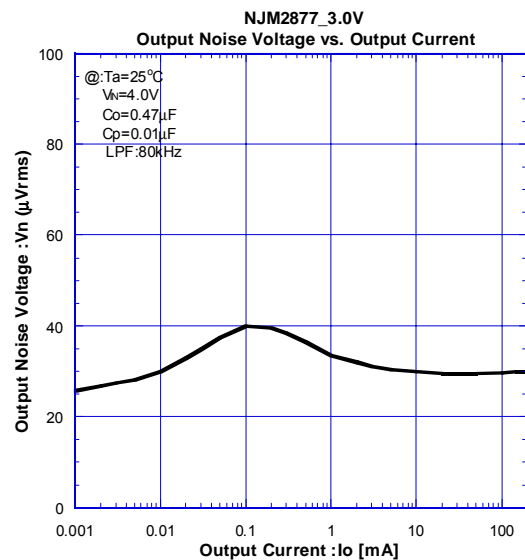
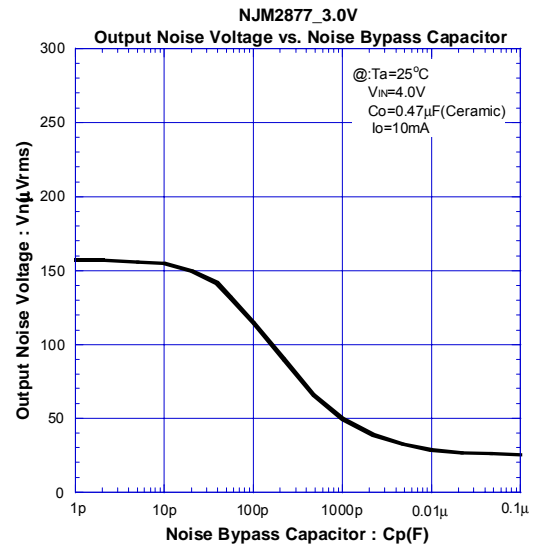
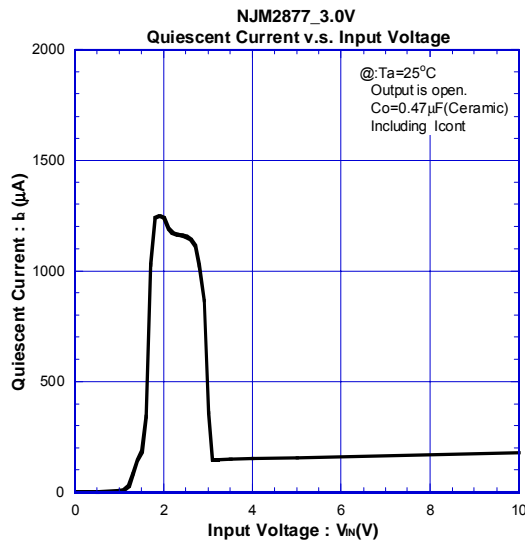
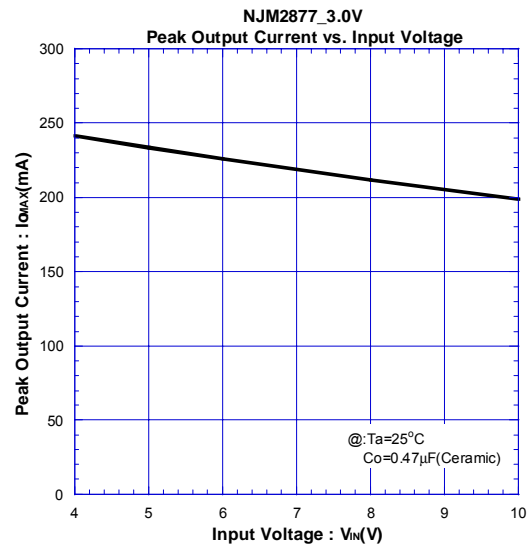
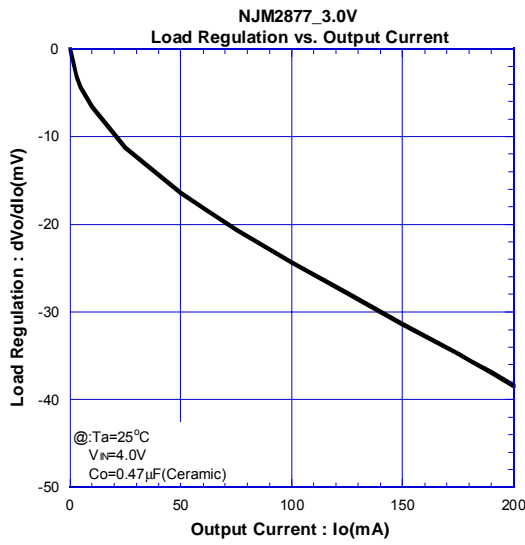

■ TYPICAL CHARACTERISTICS

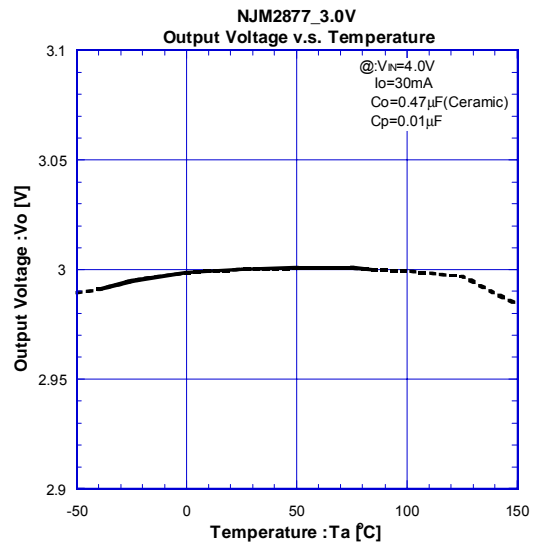
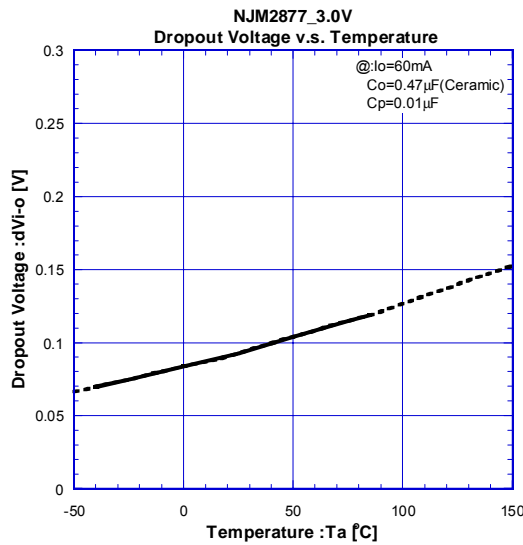
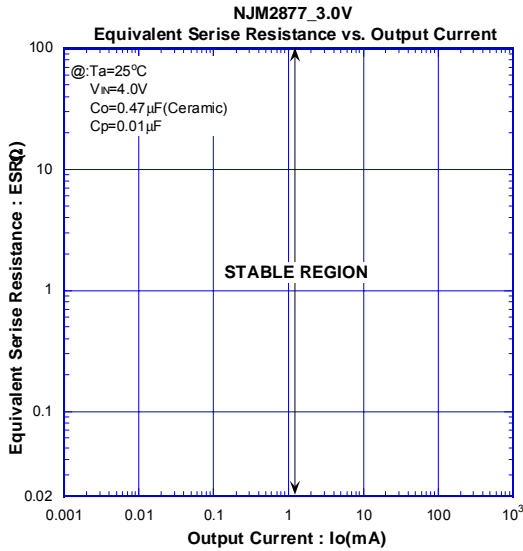
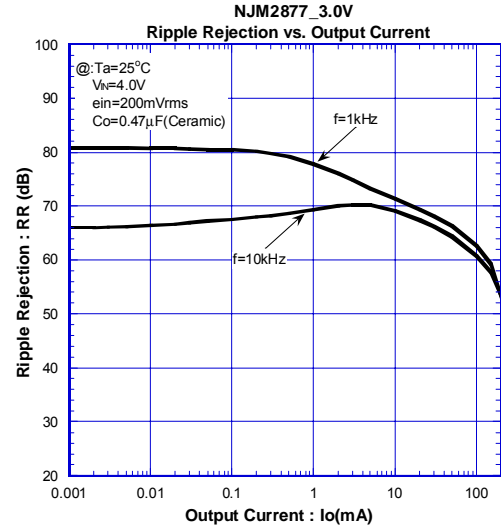
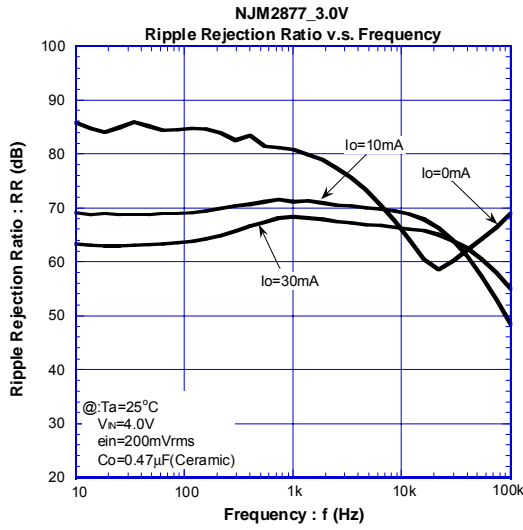

TYPICAL CHARACTERISTICS

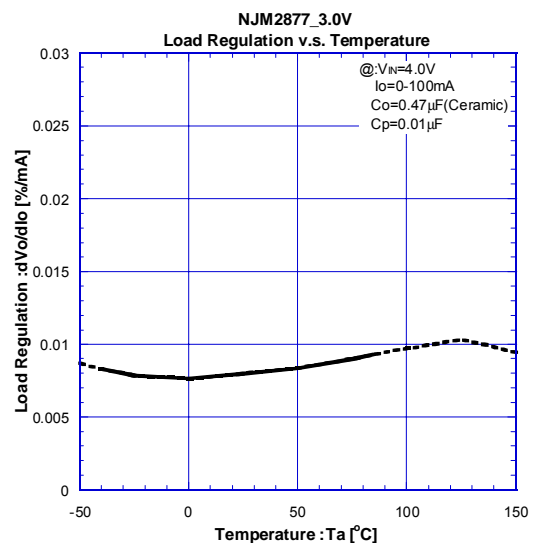
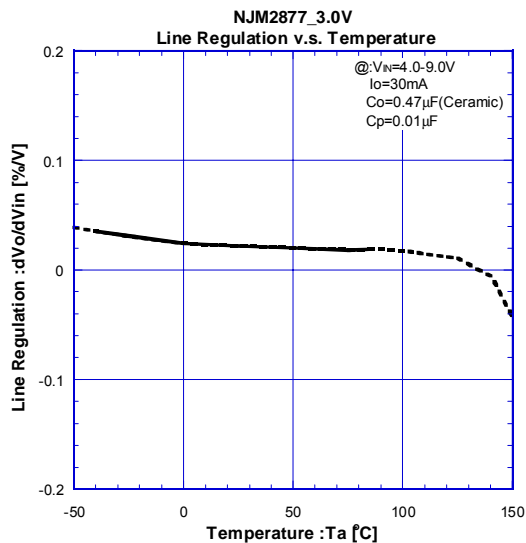
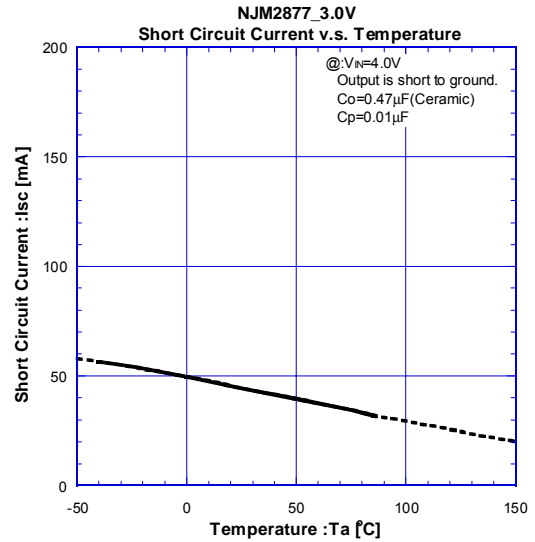
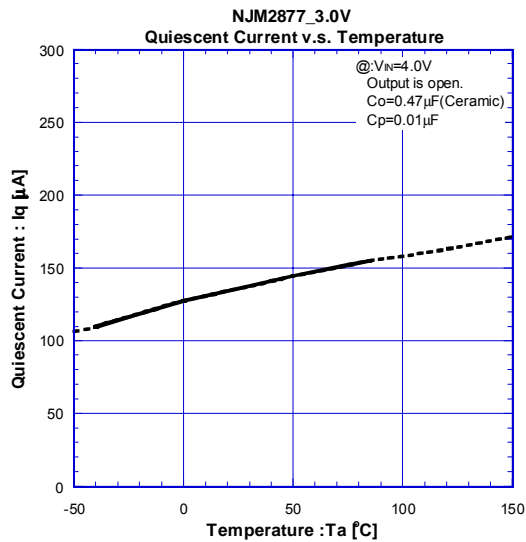
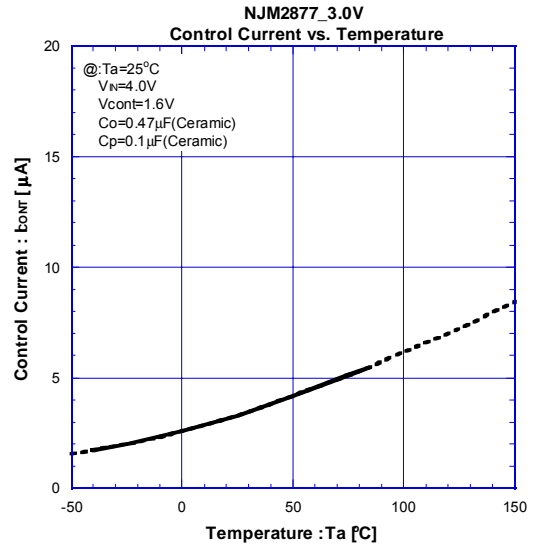
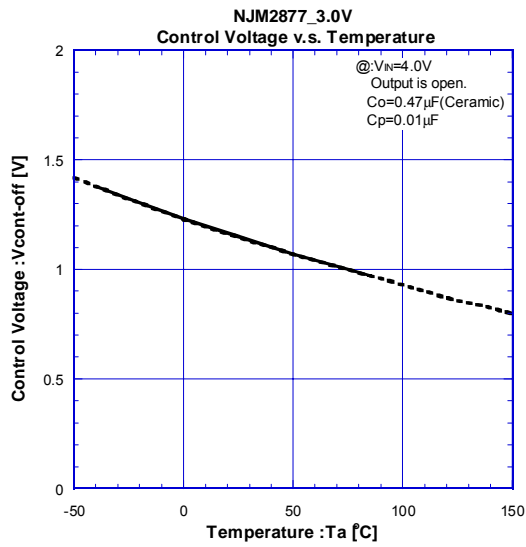

NJM2877

www.DataSheet4U.com

TYPICAL CHARACTERISTICS

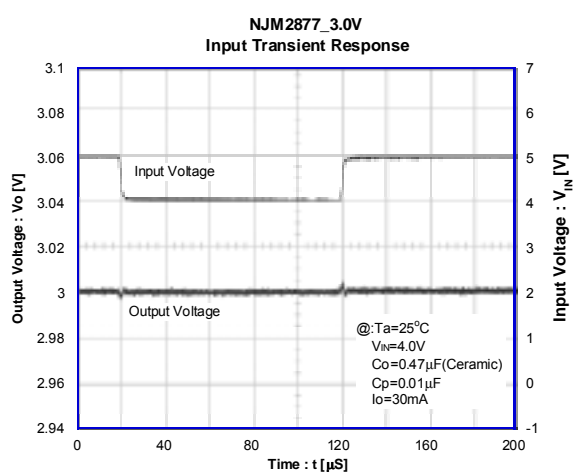
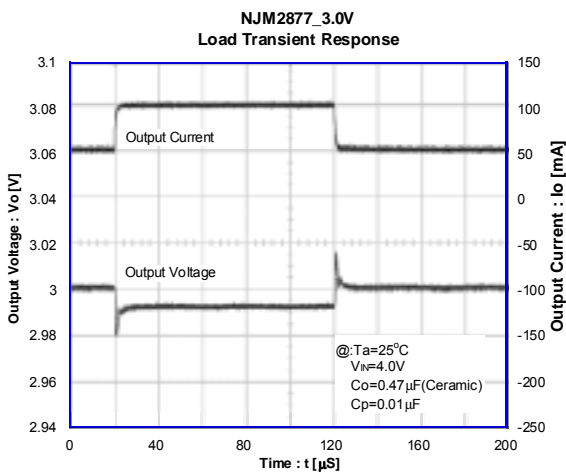
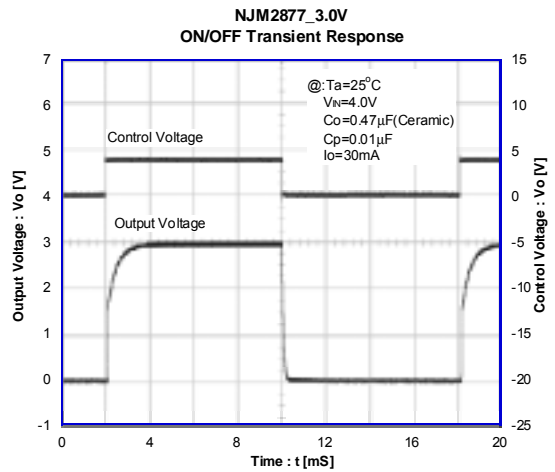
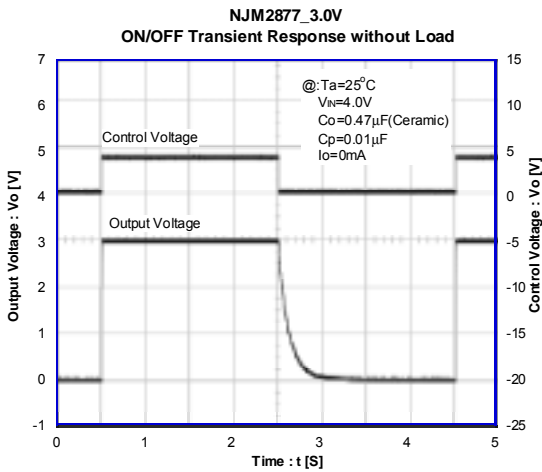
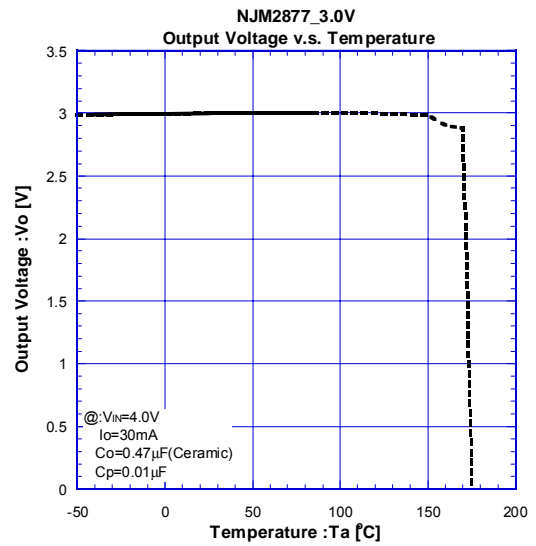
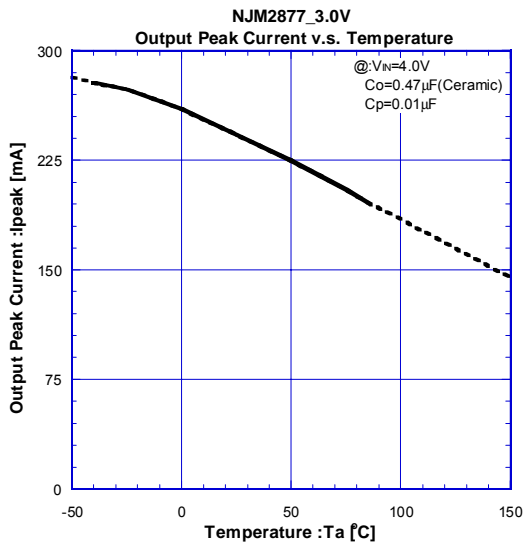

[CAUTION]

The specifications on this databook are only given for information, without any guarantee as regards either mistakes or omissions. The application circuits in this databook are described only to show representative usages of the product and not intended for the guarantee or permission of any right including the industrial rights.