

## LOW DROPOUT VOLTAGE REGULATOR

### ■ GENERAL DESCRIPTION

The NJM2884/A is a low dropout voltage regulator with ON/OFF control.

Advanced Bipolar technology achieves low noise, high ripple rejection and low quiescent current.

It delivers up to 5V/500mA output power with the maximum input voltage of 10V.

The NJM2884/A is suitable for audio/video and PC related applications.

The "U2" suffix product achieves high  $P_D$  compared with "U1" although the same package outline (SOT-89-5).

### ■ PACKAGE OUTLINE

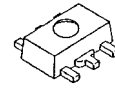

NJM2884U1/U2

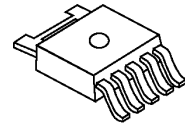

NJM2884ADL3



NJM2884AKH1(2.0×2.0×0.397mm)

### ■ FEATURES

- High Ripple Rejection      75dB typ. (f=1kHz,  $V_o=3V$  Version)
- Low Output Noise Voltage  $V_{no}=45\mu V_{rms}$  typ.
- Output capacitor with 2.2 $\mu F$  ceramic capacitor ( $V_o\geq 2.7V$ )
- Output Current               $I_o(max.)=500mA$
- High Precision Output       $V_o\pm 1.0\%$
- Low Dropout Voltage        0.18V typ. ( $I_o=300mA$ )
- ON/OFF Control Function
- Internal Thermal Overload Protection
- Internal Short Circuit Current Limit
- Bipolar Technology
- Package Outline              SOT-89-5(NJM2884U1/U2)/ TO-252-5(NJM2884ADL3)/ ESON6-H1(NJM2884AKH1)

### ■ PIN CONFIGURATION

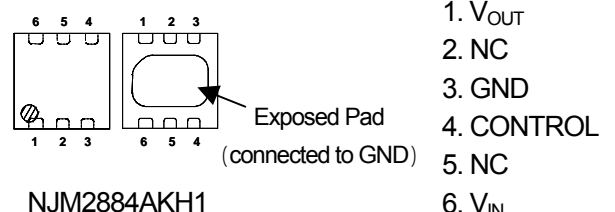
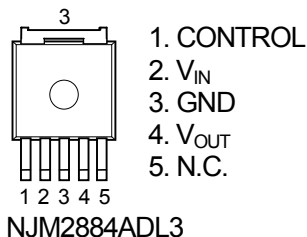
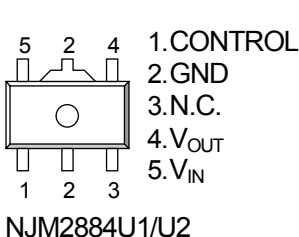

### ■ EQUIVALENT CIRCUIT

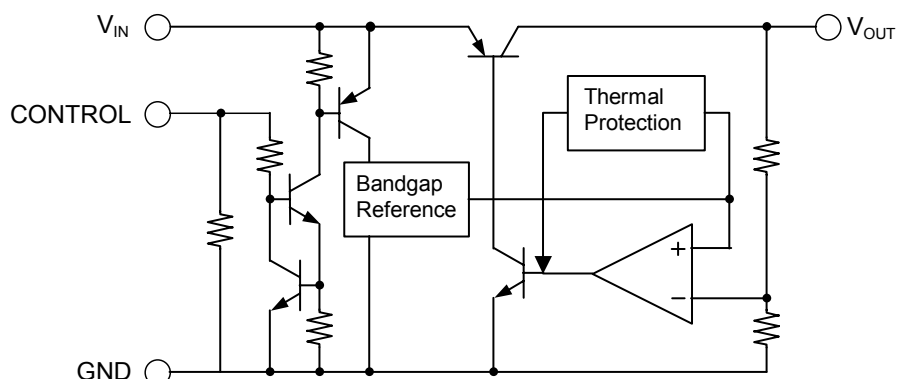

# NJM2884/A

## ■ OUTPUT VOLTAGE RANK LIST

The WHITE column shows applicable Voltage Rank(s)

Device Name	V <sub>out</sub>	Device Name	V <sub>out</sub>
NJM2884U1/U2-15	1.5V	NJM2884U1-34	3.4V
NJM2884U1-16	1.6V	NJM2884U1-35	3.5V
NJM2884U1-17	1.7V	NJM2884U1-36	3.6V
NJM2884U1/U2-18	1.8V	NJM2884U1-37	3.7V
NJM2884U1-19	1.9V	NJM2884U1-38	3.8V
NJM2884U1-02	2.0V	NJM2884U1-39	3.9V
NJM2884U1-21	2.1V	NJM2884U1-04	4.0V
NJM2884U1-22	2.2V	NJM2884U1-41	4.1V
NJM2884U1-23	2.3V	NJM2884U1-42	4.2V
NJM2884U1-24	2.4V	NJM2884U1-43	4.3V
NJM2884U1-25	2.5V	NJM2884U1-44	4.4V
NJM2884U1/U2-255	2.55V	NJM2884U1-45	4.5V
NJM2884U1-26	2.6V	NJM2884U1-46	4.6V
NJM2884U1-27	2.7V	NJM2884U1-47	4.7V
NJM2884U1-28	2.8V	NJM2884U1-48	4.8V
NJM2884U1-29	2.9V	NJM2884U1-49	4.9V
NJM2884U1-03	3.0V	NJM2884U1/U2-05	5.0V
NJM2884U1-31	3.1V		
NJM2884U1-32	3.2V		
NJM2884U1-33	3.3V		

Device Name	V <sub>out</sub>	Device Name	V <sub>out</sub>
NJM2884ADL3-15	1.5V	NJM2884ADL3-35	3.5V
NJM2884ADL3-16	1.6V	NJM2884ADL3-36	3.6V
NJM2884ADL3-17	1.7V	NJM2884ADL3-37	3.7V
NJM2884ADL3-18	1.8V	NJM2884ADL3-38	3.8V
NJM2884ADL3-19	1.9V	NJM2884ADL3-39	3.9V
NJM2884ADL3-02	2.0V	NJM2884ADL3-40	4.0V
NJM2884ADL3-21	2.1V	NJM2884ADL3-41	4.1V
NJM2884ADL3-22	2.2V	NJM2884ADL3-42	4.2V
NJM2884ADL3-23	2.3V	NJM2884ADL3-43	4.3V
NJM2884ADL3-24	2.4V	NJM2884ADL3-44	4.4V
NJM2884ADL3-25	2.5V	NJM2884ADL3-45	4.5V
NJM2884ADL3-26	2.6V	NJM2884ADL3-46	4.6V
NJM2884ADL3-27	2.7V	NJM2884ADL3-47	4.7V
NJM2884ADL3-28	2.8V	NJM2884ADL3-48	4.8V
NJM2884ADL3-29	2.9V	NJM2884ADL3-49	4.9V
NJM2884ADL3-03	3.0V	NJM2884ADL3-05	5.0V
NJM2884ADL3-31	3.1V	NJM2884AU1-15	1.5V
NJM2884ADL3-32	3.2V		
NJM2884ADL3-33	3.3V		
NJM2884ADL3-34	3.4V		

Device Name	V <sub>out</sub>	Device Name	V <sub>out</sub>
NJM2884AKH1-15	1.5V	NJM2884AKH1-35	3.5V
NJM2884AKH1-16	1.6V	NJM2884AKH1-36	3.6V
NJM2884AKH1-17	1.7V	NJM2884AKH1-37	3.7V
NJM2884AKH1-18	1.8V	NJM2884AKH1-38	3.8V
NJM2884AKH1-19	1.9V	NJM2884AKH1-39	3.9V
NJM2884AKH1-02	2.0V	NJM2884AKH1-04	4.0V
NJM2884AKH1-21	2.1V	NJM2884AKH1-41	4.1V
NJM2884AKH1-22	2.2V	NJM2884AKH1-42	4.2V
NJM2884AKH1-23	2.3V	NJM2884AKH1-43	4.3V
NJM2884AKH1-24	2.4V	NJM2884AKH1-44	4.4V
NJM2884AKH1-25	2.5V	NJM2884AKH1-45	4.5V
NJM2884AKH1-26	2.6V	NJM2884AKH1-46	4.6V
NJM2884AKH1-27	2.7V	NJM2884AKH1-47	4.7V
NJM2884AKH1-28	2.8V	NJM2884AKH1-48	4.8V
NJM2884AKH1-29	2.9V	NJM2884AKH1-49	4.9V
NJM2884AKH1-03	3.0V	NJM2884AKH1-05	5.0V
NJM2884AKH1-31	3.1V		
NJM2884AKH1-32	3.2V		
NJM2884AKH1-33	3.3V		
NJM2884AKH1-34	3.4V		

# NJM2884/A

## ■ ABSOLUTE MAXIMUM RATINGS (Ta=25°C)

PARAMETER	SYMBOL	RATINGS	UNIT	
Input Voltage	V <sub>IN</sub>	+10	V	
Control Voltage	V <sub>CONT</sub>	+10	V	
Power Dissipation	P <sub>D</sub>	SOT-89-5 (U1)	625(*1)	mW
			960(*2)	
		SOT-89-5 (U2)	625(*1)	
			2400(*2)	
		TO-252-5	1190(*1)	
			3125(*2)	
ESON6-H1	445(*3)			
	1135(*4)			
Operating Temperature	Topr	- 40 ~ +85	°C	
Storage Temperature	Tstg	- 40 ~ +150	°C	

(\*1): Mounted on glass epoxy board. (76.2 x 114.3 x 1.6mm:based on EIA/JDEC standard size, 2Layers, Cu area 100mm<sup>2</sup>)

(\*2): Mounted on glass epoxy board. (76.2 x 114.3 x 1.6mm:based on EIA/JDEC standard, 4Layers)

(4Layers: Applying 74.2 x 74.2mm inner Cu area and a thermal via hall to a board based on JEDEC standard JESD51-5)

(\*3): Mounted on glass epoxy board (101.5x114.5x1.6mm: based on EIA/JEDEC standard, 2Layers FR-4, with Exposed Pad)

(\*4): Mounted on glass epoxy board (101.5x114.5x1.6mm: based on EIA/JEDEC standard, 4Layers FR-4, with Exposed Pad)

(4Layers: Applying 99.5x99.5mm inner Cu area and a thermal via hole to a board based on JEDEC standard JESD51-5)

## ■ INPUT VOLTAGE RANGE

V<sub>IN</sub>=+2.3V~9V ( In case of Vo<2.1V )

## ■ ELECTRICAL CHARACTERISTICS

(V<sub>IN</sub>=Vo+1V, C<sub>IN</sub>=0.33μF, Co=2.2μF: Vo≥2.7V (Co=4.7μF : 1.7V<Vo≤2.6V, Co=10μF : Vo≤1.7V), Ta=25°C)

PARAMETER	SYMBOL	TEST CONDITION	MIN.	TYP.	MAX.	UNIT
Output Voltage	Vo	Io=30mA	-1.0%	-	+1.0%	V
Quiescent Current	I <sub>Q</sub>	Io=0mA	-	200	300	μA
Quiescent Current at Control OFF	I <sub>Q(OFF)</sub>	V <sub>CONT</sub> =0V	-	-	100	nA
Output Current	Io	Vo - 0.3V	500	650	-	mA
Line Regulation	ΔVo/ΔV <sub>IN</sub>	V <sub>IN</sub> =Vo+1V ~ Vo+6V (Vo≤3V Version), V <sub>IN</sub> =Vo+1V ~ 9V (Vo>3V Version), Io=30mA	-	-	0.10	%/V
Load Regulation	ΔVo/ΔIo	Io=0 ~ 500mA	-	-	0.009	%/mA
Dropout Voltage (*5)	ΔV <sub>LO</sub>	Io=300mA	-	0.18	0.28	V
Ripple Rejection	RR	ein=200mVrms, f=1kHz, Io=10mA, Vo=3V Version	-	75	-	dB
Average Temperature Coefficient of Output Voltage	ΔVo/ΔTa	Ta=0 ~ +85°C, Io=10mA	-	± 50	-	ppm/°C
Output Noise Voltage	V <sub>NO</sub>	f=10Hz ~ 80kHz, Io=10mA, Vo=3V Version	-	45	-	μVrms
Control Current	I <sub>CONT</sub>	V <sub>CONT</sub> =1.6V	-	3	12	μA
Control Voltage for ON-state	V <sub>CONT(ON)</sub>		1.6	-	-	V
Control Voltage for OFF-state	V <sub>CONT(OFF)</sub>		-	-	0.6	V

(\*5): The output voltage excludes under 2.1V.

The above specification is a common specification for all output voltages.

Therefore, it may be different from the individual specification for a specific output voltage.

## POWER DISSIPATION vs. AMBIENT TEMPERATURE

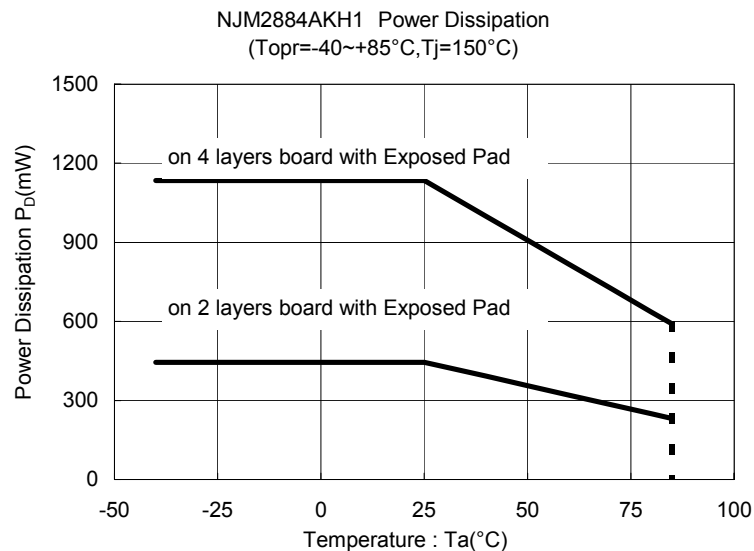
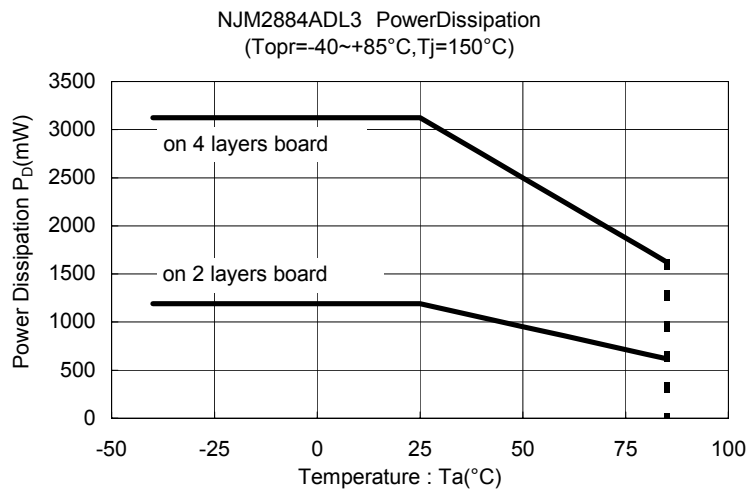
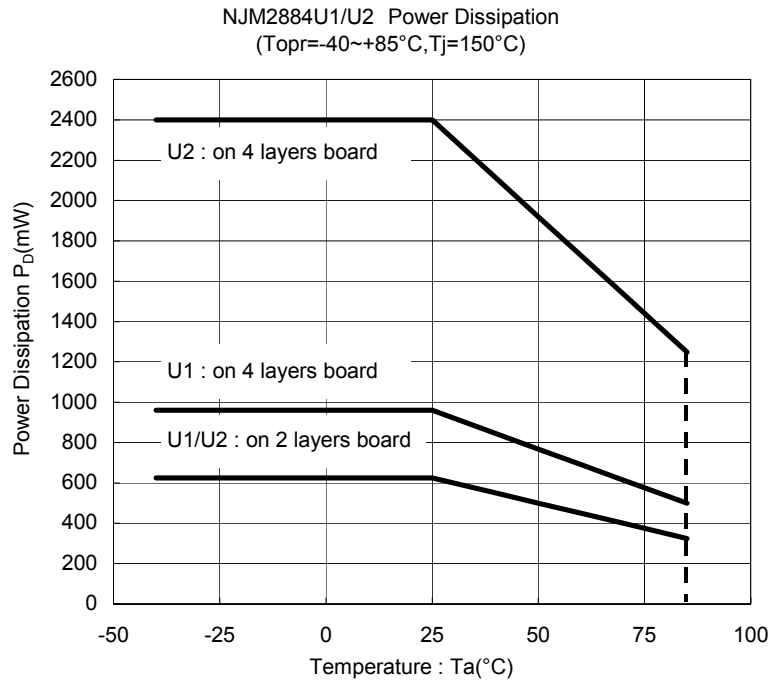

# NJM2884/A

## ■ TEST CIRCUIT

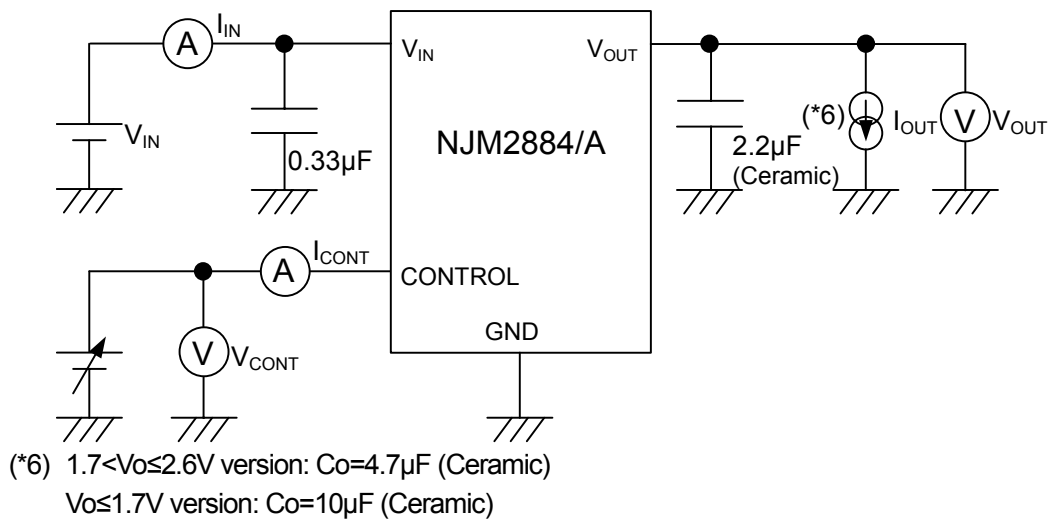

## ■ TYPICAL APPLICATION

① In the case where ON/OFF Control is not required:

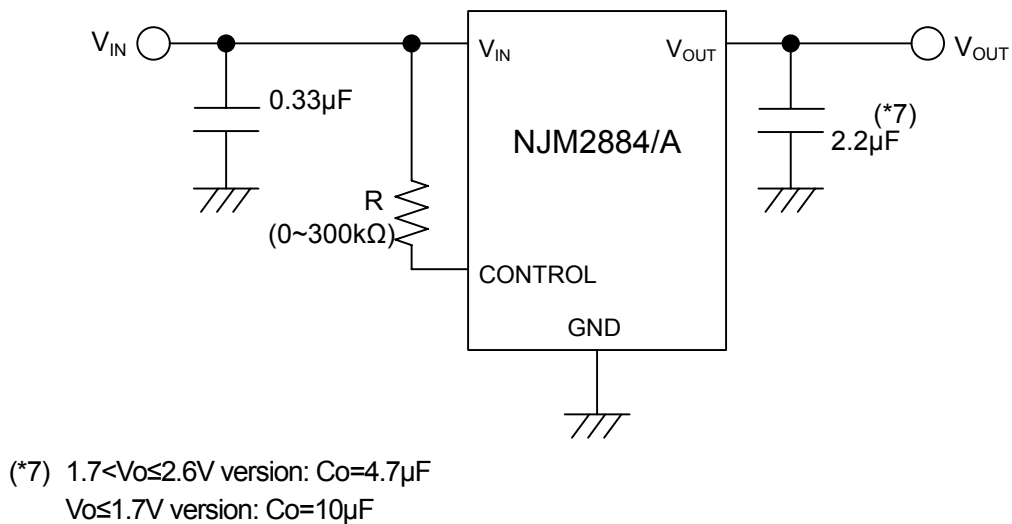

② In use of ON/OFF CONTROL:

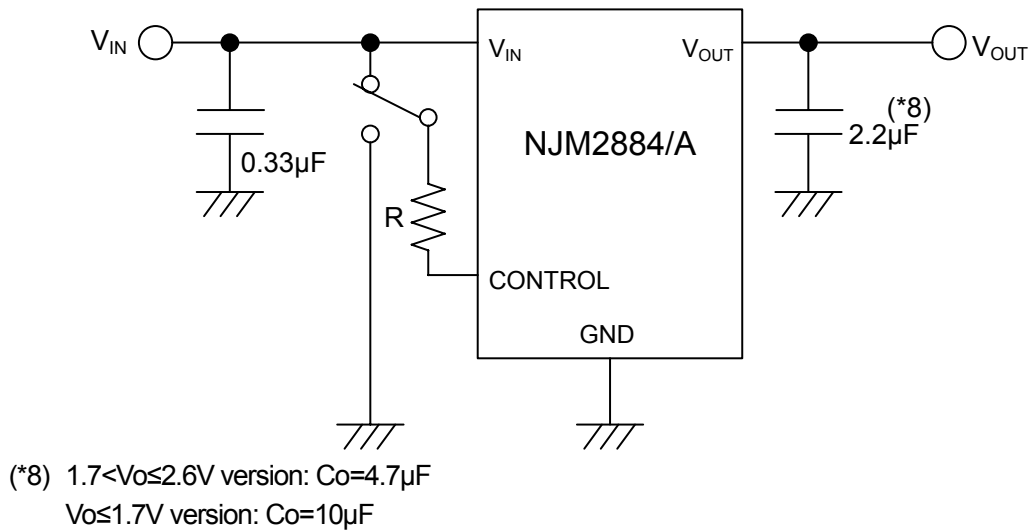

State of control terminal:

- “H” → output is enabled.
- “L” or “open” → output is disabled.

\*In the case of using a resistance "R" between  $V_{IN}$  and control.

If this resistor is inserted, it can reduce the control current when the control voltage is high.

The applied voltage to control terminal should set to consider voltage drop through the resistor "R" and the minimum control voltage for ON-state.

The  $V_{CONT(ON)}$  and  $I_{CONT}$  have temperature dependence as shown in the "Control Current vs. Temperature" and "Control Voltage vs. Temperature" characteristics. Therefore, the resistance "R" should be selected to consider the temperature characteristics.

## \*Input Capacitor $C_{IN}$

Input Capacitor  $C_{IN}$  is required to prevent oscillation and reduce power supply ripple for applications when high power supply impedance or a long power supply line.

Therefore, use the recommended  $C_{IN}$  value (refer to conditions of ELECTRIC CHARACTERISTIC) or larger and should connect between GND and  $V_{IN}$  as shortest path as possible to avoid the problem.

## \*Output Capacitor $C_O$

Output capacitor ( $C_O$ ) will be required for a phase compensation of the internal error amplifier.

The capacitance and the equivalent series resistance (ESR) influence to stable operation of the regulator.

Use of a smaller  $C_O$  may cause excess output noise or oscillation of the regulator due to lack of the phase compensation.

On the other hand, Use of a larger  $C_O$  reduces output noise and ripple output, and also improves output transient response when rapid load change.

Therefore, use the recommended  $C_O$  value (refer to conditions of ELECTRIC CHARACTERISTIC) or larger and should connect between GND and  $V_{OUT}$  as shortest path as possible for stable operation

The recommended capacitance depends on the output voltage rank. Especially, low voltage regulator requires larger  $C_O$  value.

In addition, you should consider varied characteristics of capacitor (a frequency characteristic, a temperature characteristic, a DC bias characteristic and so on) and unevenness peculiar to a capacitor supplier enough.

When selecting  $C_O$ , recommend that have withstand voltage margin against output voltage and superior temperature characteristic.



## ■ TYPICAL CHARACTERISTICS

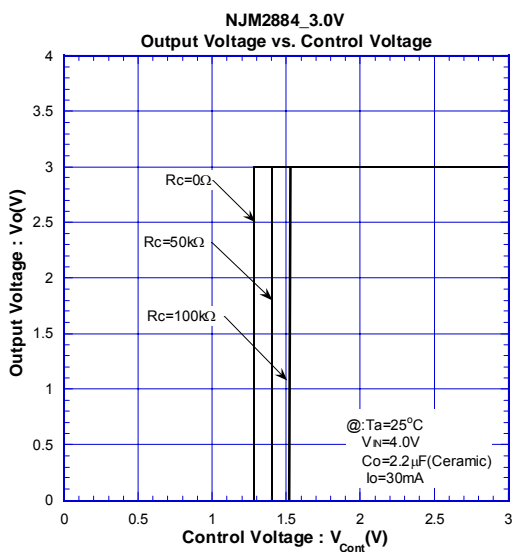
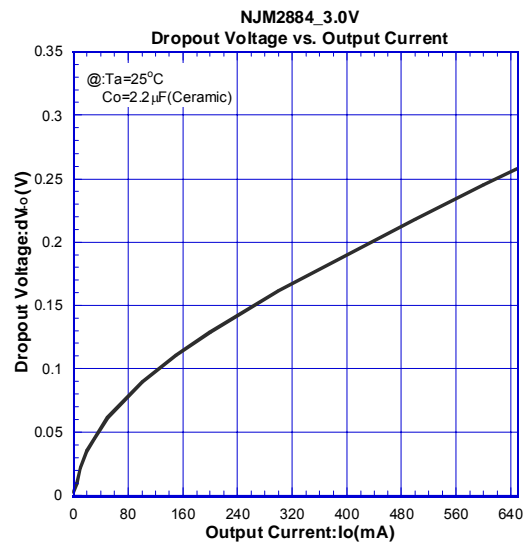
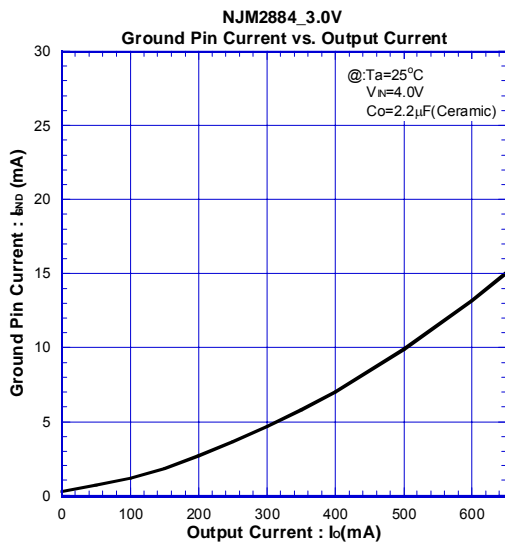
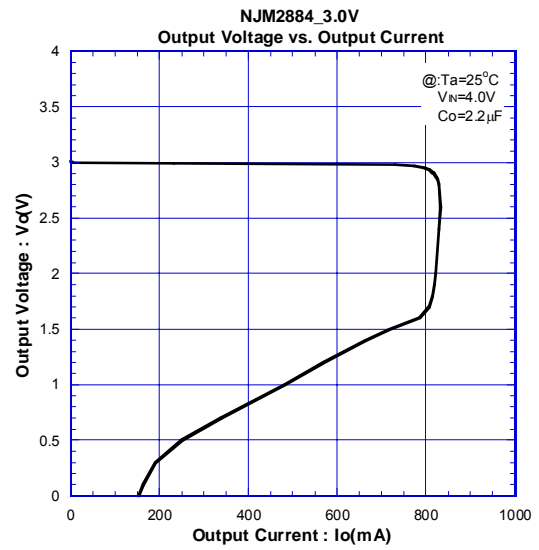
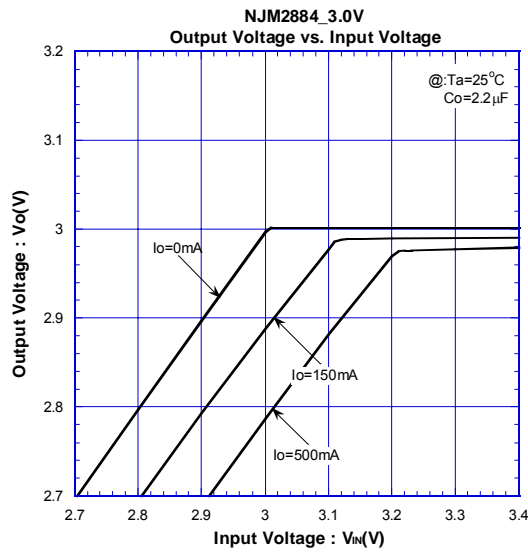

# NJM2884/A

## TYPICAL CHARACTERISTICS

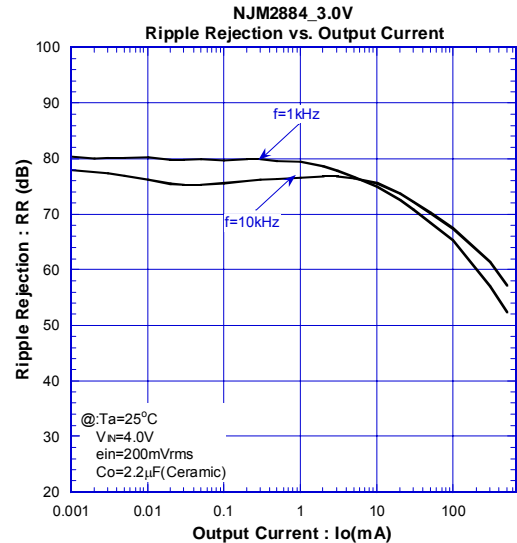
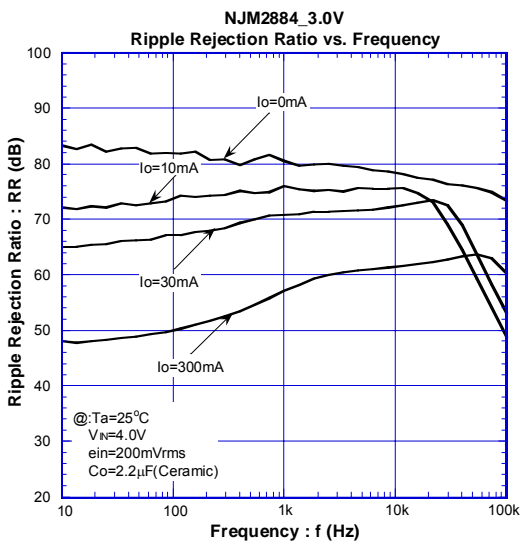
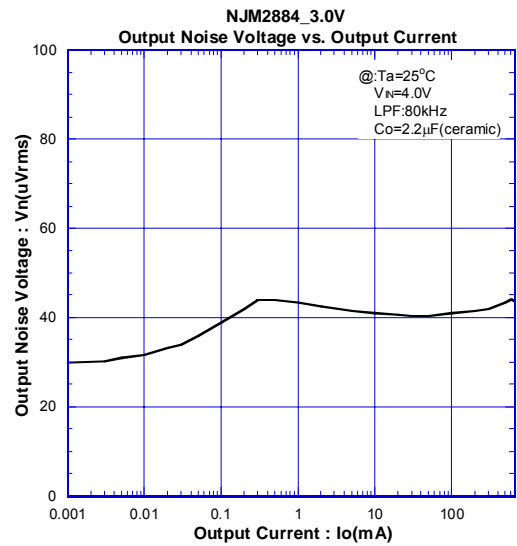
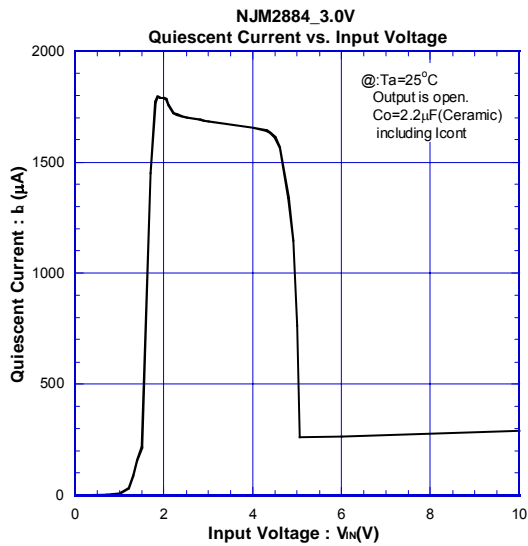
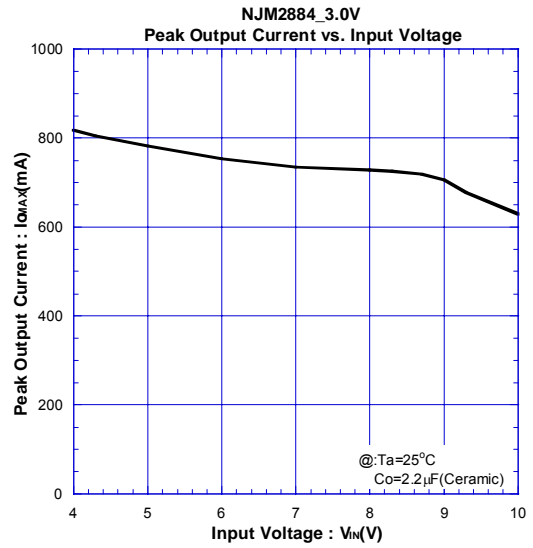
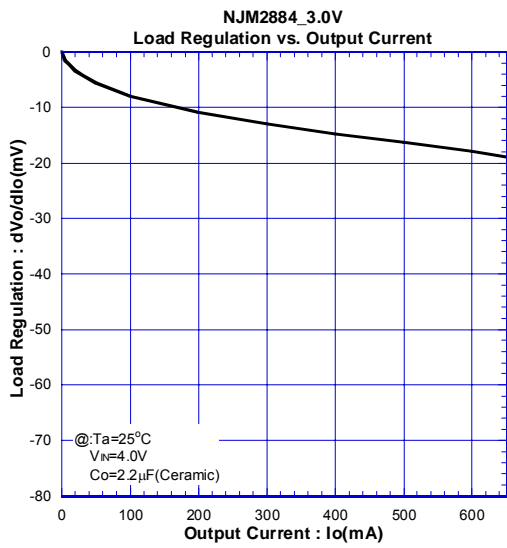

## ■ TYPICAL CHARACTERISTICS

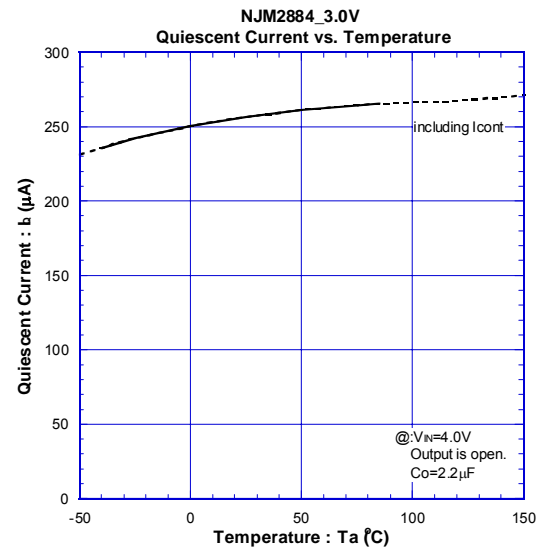
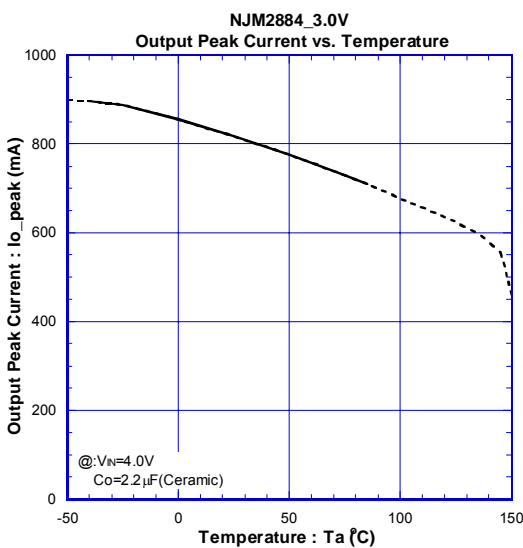
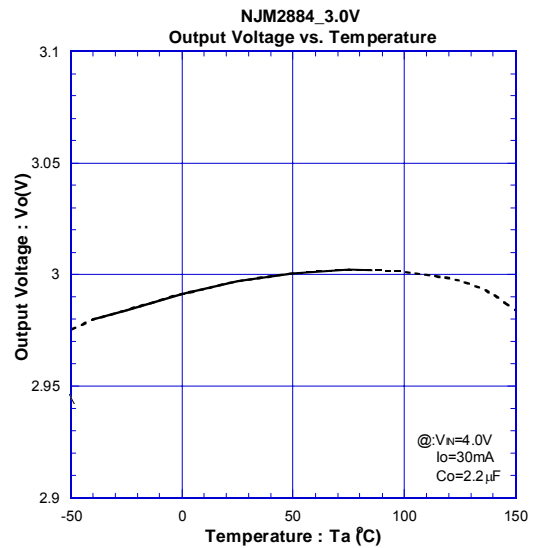
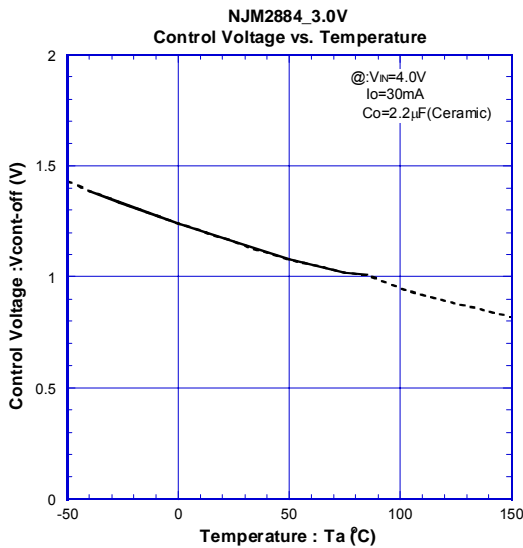
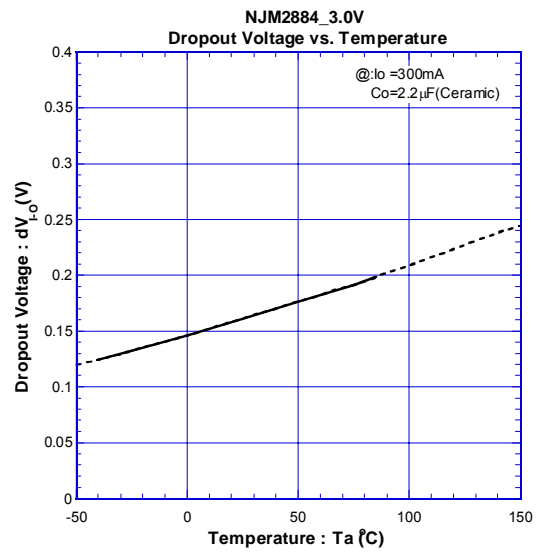
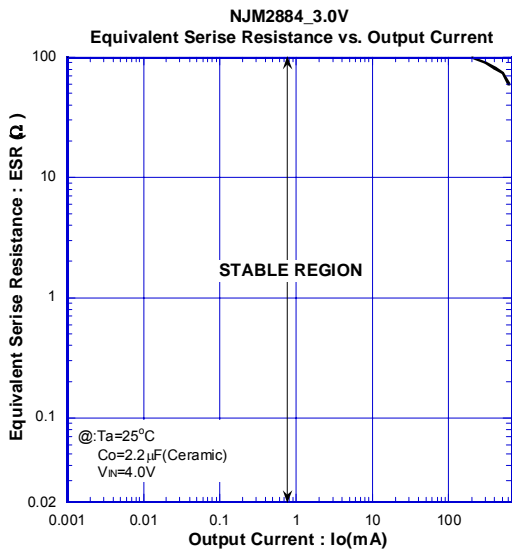

# NJM2884/A

## ■ TYPICAL CHARACTERISTICS

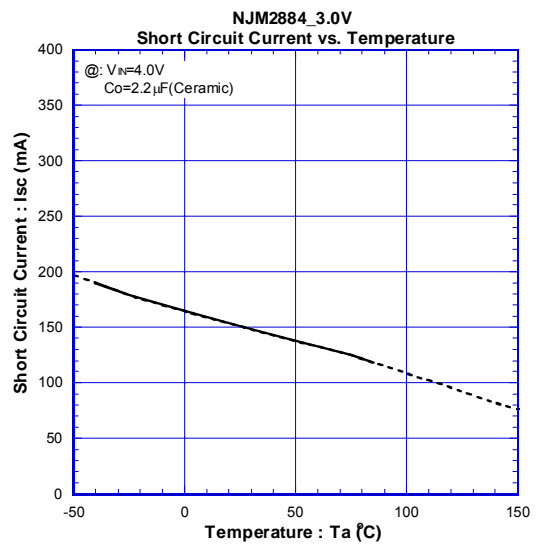
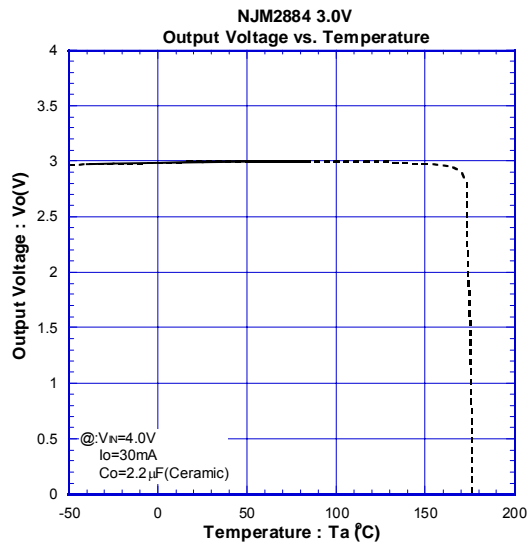
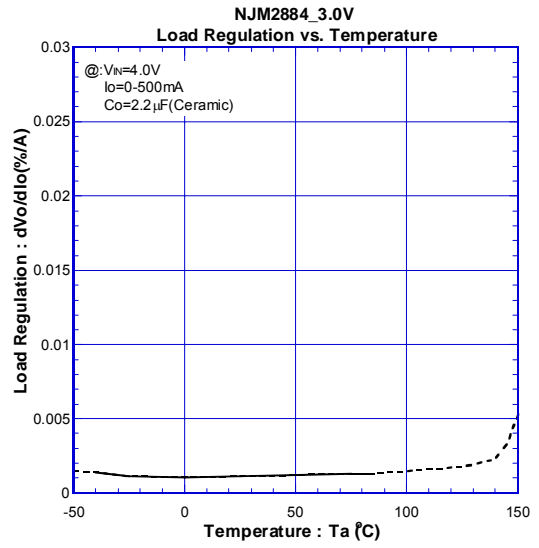
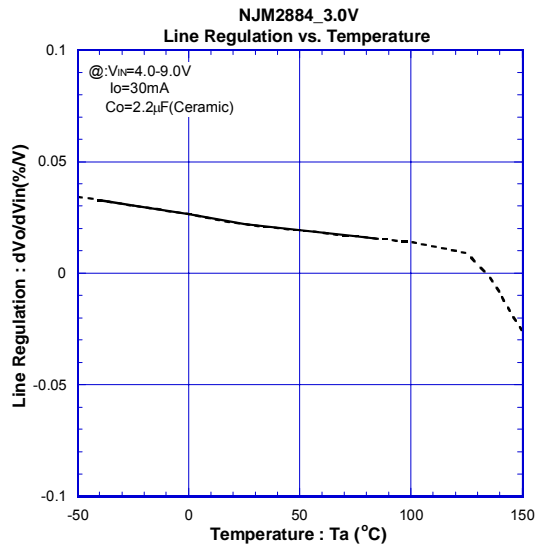

## ■ TYPICAL CHARACTERISTICS

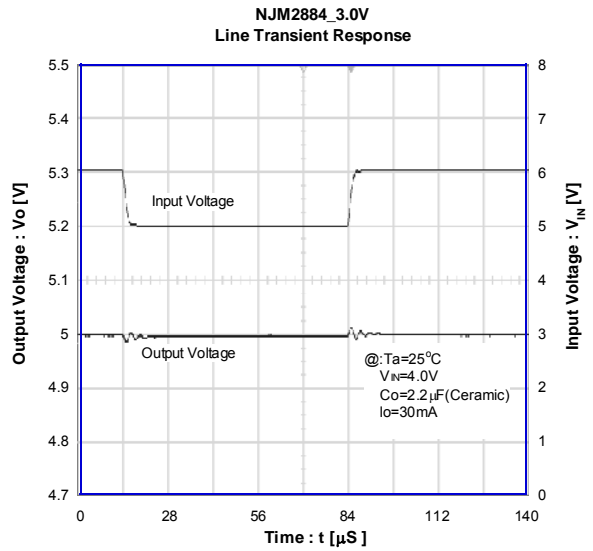
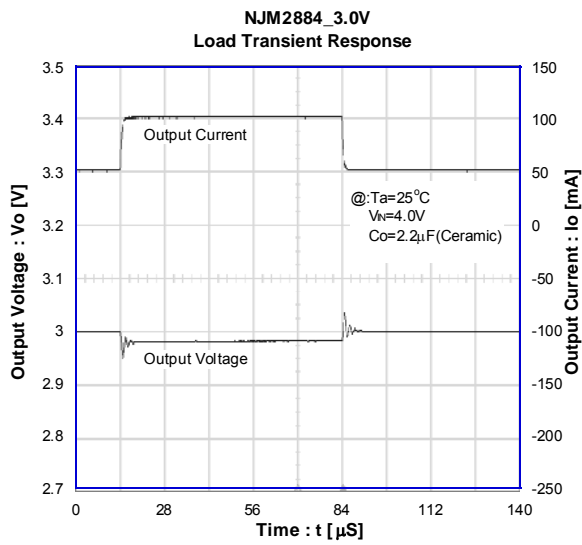
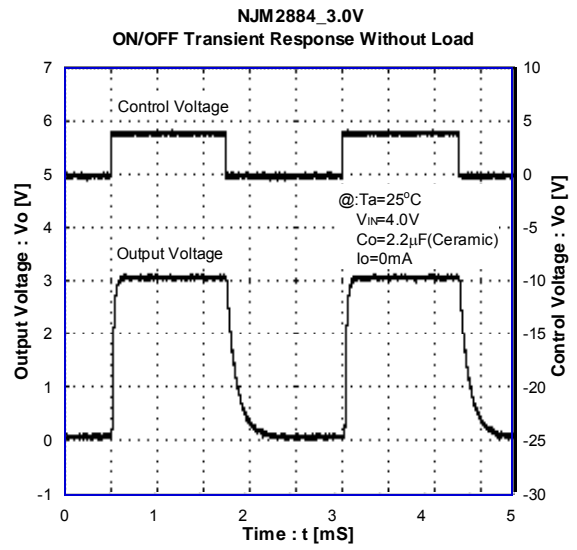
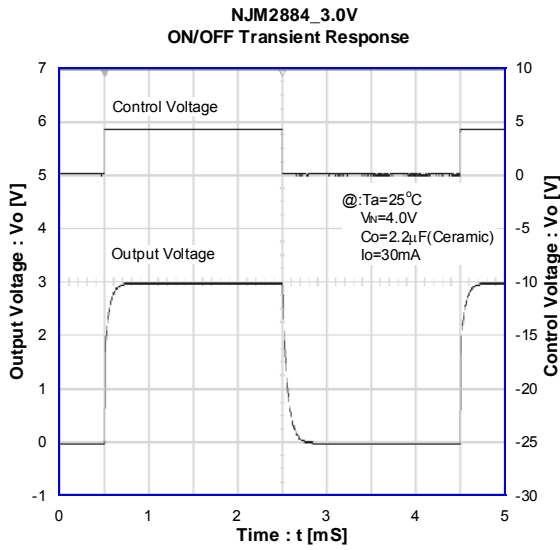

**[CAUTION]**

The specifications on this databook are only given for information, without any guarantee as regards either mistakes or omissions. The application circuits in this databook are described only to show representative usages of the product and not intended for the guarantee or permission of any right including the industrial rights.