

2ch LOW DROPOUT VOLTAGE REGULATOR

■ GENERAL DESCRIPTION

The NJM2895/96 is a 2ch low dropout voltage regulator with ON/OFF control.

Advanced Bipolar technology achieves low noise, high ripple rejection and low quiescent current.

■ PACKAGE OUTLINE

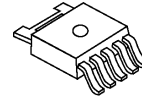

NJM2895/96DL3

■ FEATURES

- High Ripple Rejection 75dB typ. (f=1kHz $V_o=3V$ version)
- Output Noise Voltage $V_{no}=40\mu V_{rms}$ typ.
- Output capacitor with 1.0 μF ceramic capacitor ($V_o\geq 2.5V$)
- Output Current $I_o(max.)=500mA \times 2ch$
- High Precision Output $V_o\pm 1.0\%$
- Low Dropout Voltage 0.18V typ. ($I_o=300mA$)
- ON/OFF Control (NJM2895 : ch1/ch2 common, NJM2896 ch2 only)
- Internal Short Circuit Current Limit
- Internal Thermal Overload Protection
- Bipolar Technology
- Package Outline TO-252-5

■ PIN CONFIGURATION

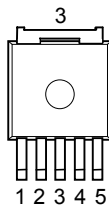

1. V_{OUT1}
2. V_{IN}
3. GND
4. V_{OUT2}
5. CONTROL (Active High)

NJM2895/96DL3

NJM2895/96

www.DataSheet4U.com

■ EQUIVALENT CIRCUIT

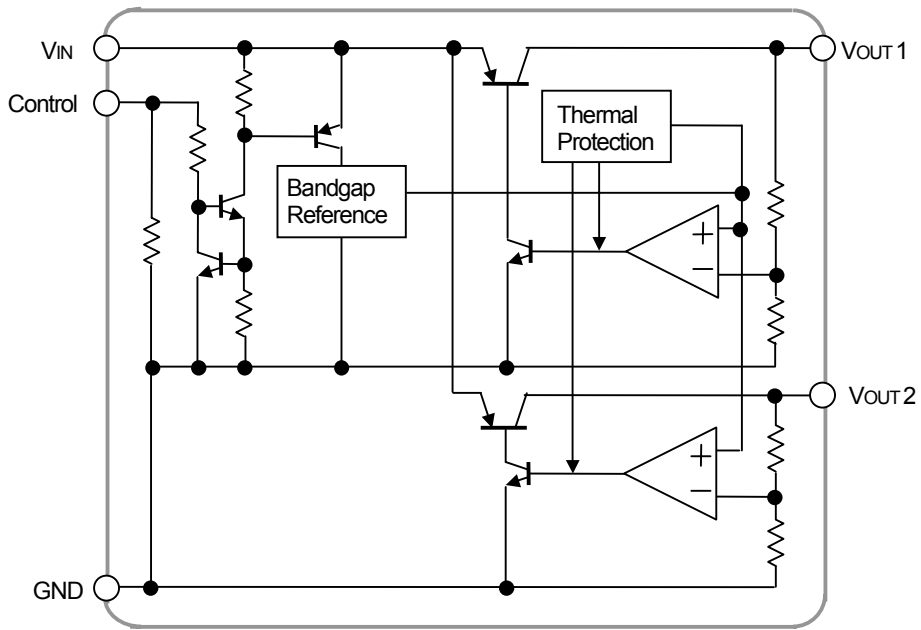

NJM2895

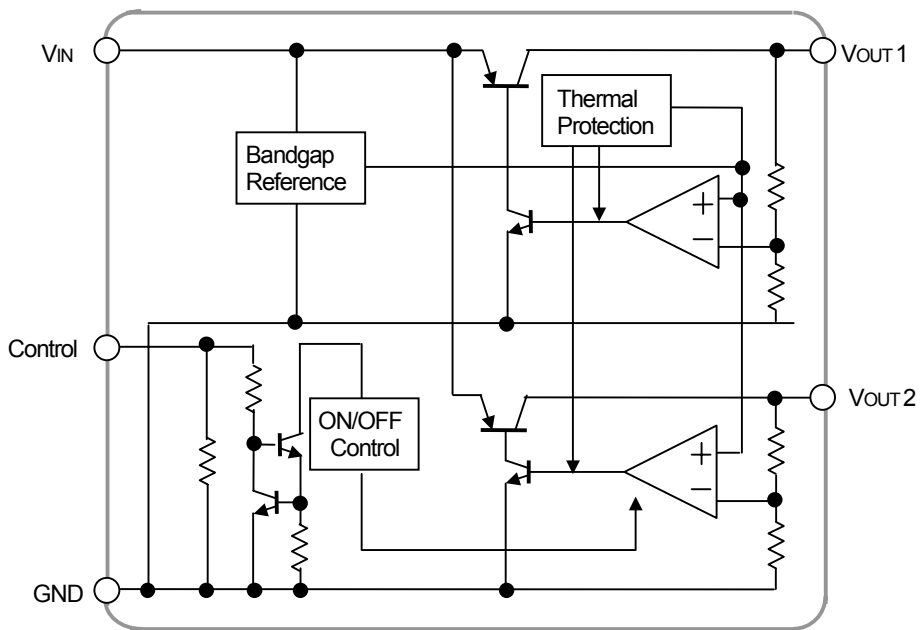

NJM2896

■ OUTPUT VOLTAGE RANK LIST

Device Name	V _{OUT}	
	Ch 1	Ch 2
NJM289*DL3-2121	2.1V	2.1V
NJM289*DL3-0303	3.0V	3.0V
NJM289*DL3-0533	5.0V	3.3V
NJM289*DL3-0505	5.0V	5.0V

■ ABSOLUTE MAXIMUM RATINGS

(Ta=25°C)

PARAMETER	SYMBOL	RATINGS	UNIT
Input Voltage	V _{IN}	+14	V
Control Voltage	V _{CONT}	+14(*1)	V
Power Dissipation	P _D	8(Tc=25°C) 0.8(Ta≤25°C)	W
Operating Temperature	Topr	-40 ~ +85	°C
Storage Temperature	Tstg	-40 ~ +125	°C

(*1): When input voltage is less than +14V, the absolute maximum control voltage is equal to the input voltage.

■ NJM2895

■ ELECTRICAL CHARACTERISTICS (V_{IN}=Vo+1V, C_{IN}=0.33μF, Co=1.0μF (Vo≤2.4V : Co=2.2μF), Ta=25°C)

PARAMETER	SYMBOL	TEST CONDITION	MIN.	TYP.	MAX.	UNIT
Output Voltage	Vo	Io=30mA	-1.0%	-	+1.0%	V
Quiescent Current	I _{Q1}	Io=0mA	-	400	600	μA
Quiescent Current at Control OFF	I _{Q(OFF)}	V _{CONT} =0V	-	-	100	nA
Output Current	Io	Vo-0.3V	500	650	-	mA
Line Regulation	ΔVo/ΔV _{IN}	V _{IN} =Vo+1V ~ Vo+6V, Io=30mA	-	-	0.10	%/V
Load Regulation	ΔVo/ΔIo	Io=0 ~ 500mA	-	-	0.03	%/mA
Dropout Voltage	ΔV _{LO}	Io=300mA	-	0.18	0.28	V
Ripple Rejection	RR	ein=200mVrms, f=1kHz, Io=10mA, Vo=3V version	-	75	-	dB
Average Temperature Coefficient of Output Voltage	ΔVo/ΔTa	Ta=0 ~ 85°C, Io=10mA	-	± 50	-	ppm/°C
Output Noise Voltage	V _{NO}	f=10Hz ~ 80kHz, Io=10mA, Vo=3V version	-	40	-	μVrms
Control Voltage for ON-state	V _{CONT(ON)}		1.6	-	-	V
Control Voltage for OFF-state	V _{CONT(OFF)}		-	-	0.6	V

NJM2895/96

www.DataSheet4U.com

■ NJM2896

■ ELECTRICAL CHARACTERISTICS ($V_{IN}=V_o+1V$, $C_{IN}=0.33\mu F$, $C_o=1.0\mu F$ ($V_o\leq 2.4V$: $C_o=2.2\mu F$), $T_a=25^\circ C$)

PARAMETER	SYMBOL	TEST CONDITION	MIN.	TYP.	MAX.	UNIT
Output Voltage	V_o	$I_o=30mA$	-1.0%	-	+1.0%	V
Quiescent Current 2	I_{Q1}	$I_o=0mA$, $V_{CONT}=0V$, expect I_{CONT}	-	200	300	μA
Quiescent Current 2	I_{Q2}	$I_o=0mA$, $V_{CONT}=0V$, expect I_{CONT}	-	400	600	μA
Output Current	I_o	$V_o=0.3V$	500	650	-	mA
Line Regulation	$\Delta V_o/\Delta V_{IN}$	$V_{IN}=V_o+1V \sim V_o+6V$, $I_o=30mA$	-	-	0.10	%/V
Load Regulation	$\Delta V_o/\Delta I_o$	$I_o=0 \sim 500mA$	-	-	0.03	%/mA
Dropout Voltage	ΔV_{LO}	$I_o=300mA$	-	0.18	0.28	V
Ripple Rejection	RR	$e_{in}=200mV_{rms}$, $f=1kHz$, $I_o=10mA$, $V_o=3V$ version	-	75	-	dB
Average Temperature Coefficient of Output Voltage	$\Delta V_o/\Delta T_a$	$T_a=0 \sim 85^\circ C$, $I_o=10mA$	-	± 50	-	ppm/ $^\circ C$
Output Noise Voltage	V_{NO}	$f=10Hz \sim 80kHz$, $I_o=10mA$, $V_o=3V$ version	-	40	-	μV_{rms}
Control Voltage for ON-state	$V_{CONT(ON)}$		1.6	-	-	V
Control Voltage for OFF-state	$V_{CONT(OFF)}$		-	-	0.6	V

(*2): $V_{IN}=V_o+1V$ means add 1V to higher output voltage.

The above specification is a common specification for all output voltages.

Therefore, it may be different from the individual specification for a specific output voltage.

■ TEST CIRCUIT

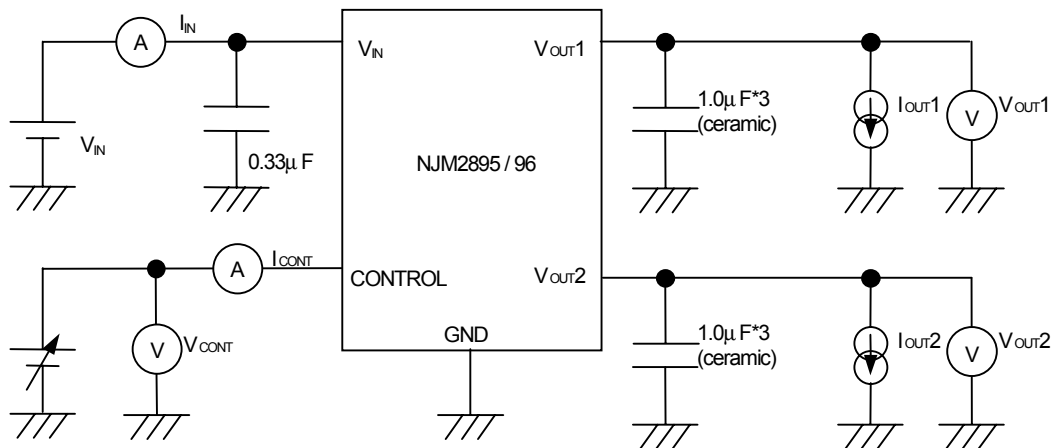

*3 $V_o\leq 2.4V$ version: $C_o=2.2\mu F$ (ceramic)

■ TYPICAL APPLICATION

① In the case where ON/OFF Control is not required:

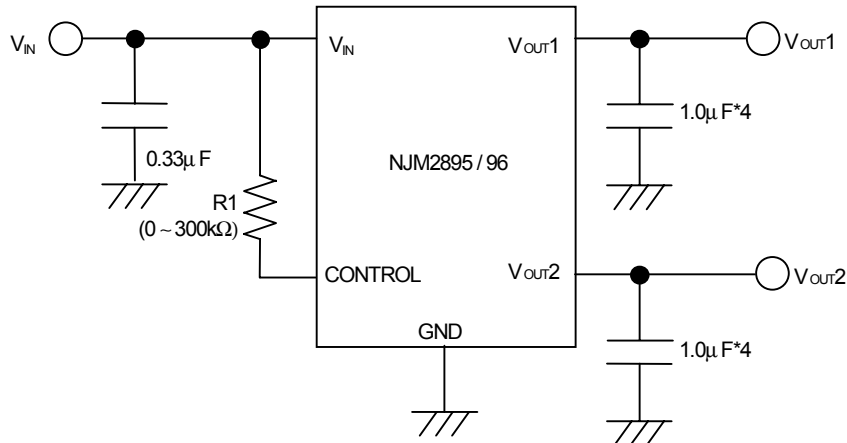

*4 $V_{O} \leq 2.4V$ version: $C_o = 2.2\mu F$

Connect control terminal to V_{IN} terminal

② In use of ON/OFF CONTROL:

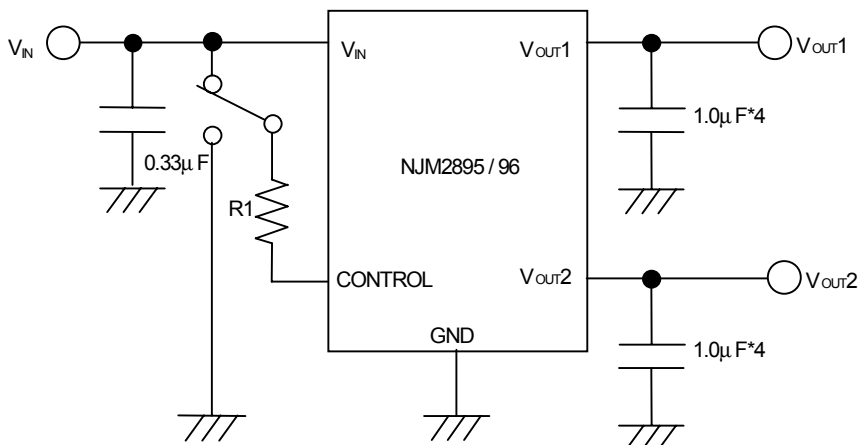

*4 $V_{O} \leq 2.4V$ version: $C_o = 2.2\mu F$

State of control terminal:

- "H" → output is enabled.
- "L" or "open" → output is disabled.

*In the case of using a resistance "R" between V_{IN} and control.

The current flow into the control terminal while the IC is ON state (I_{CONT}) can be reduced when a pull up resistance "R" is inserted between V_{IN} and the control terminal.

The minimum control voltage for ON state ($V_{CONT(ON)}$) is increased due to the voltage drop caused by I_{CONT} and the resistance "R". The I_{CONT} is temperature dependence as shown in the "Control Current vs. Temperature" characteristics. Therefore, the resistance "R" should be carefully selected to ensure the control voltage exceeds the $V_{CONT(ON)}$ over the required temperature range.

NJM2895/96

www.DataSheet4U.com

POWER DISSIPATION VS. AMBIENT TEMPERATURE

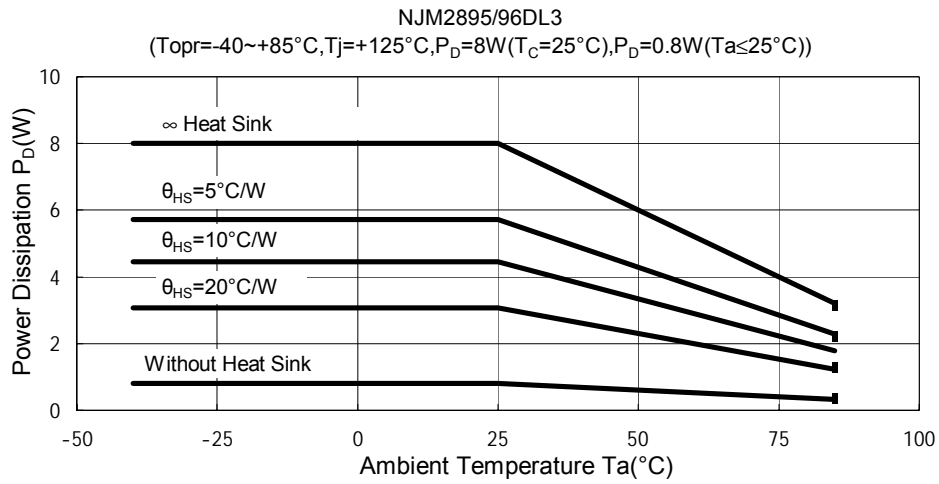

ELECTRICAL CHARACTERISTICS

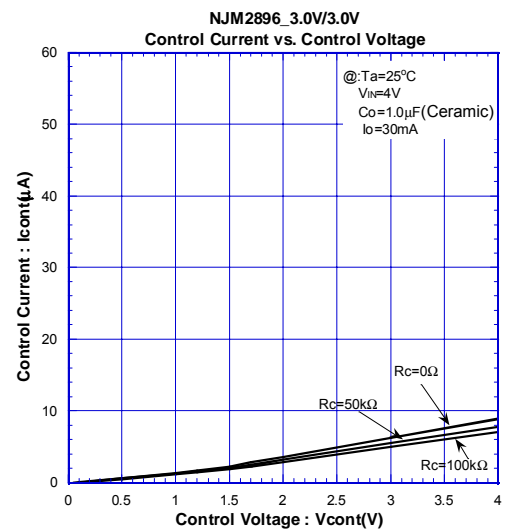
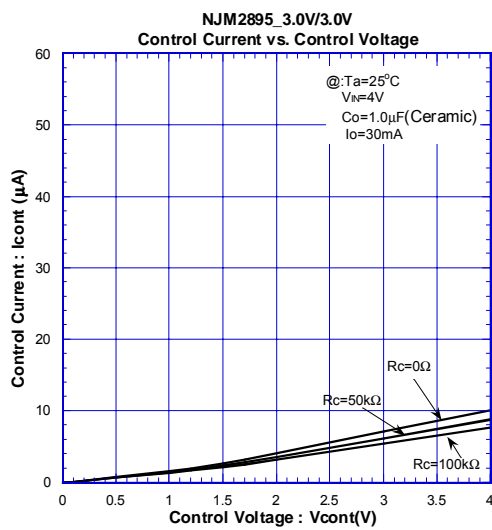
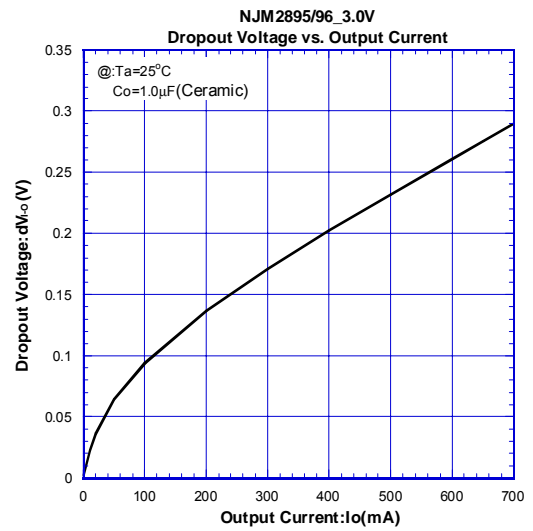
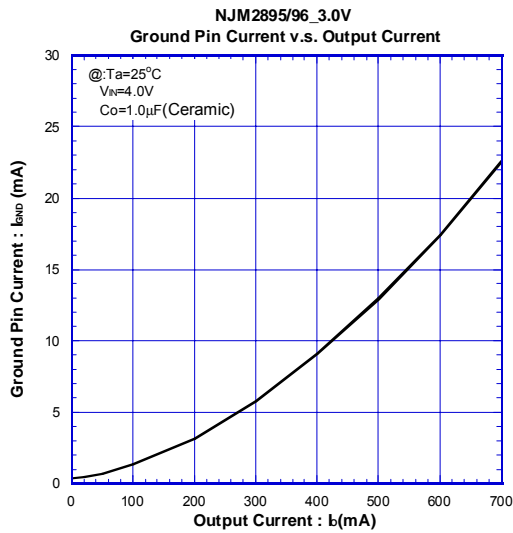
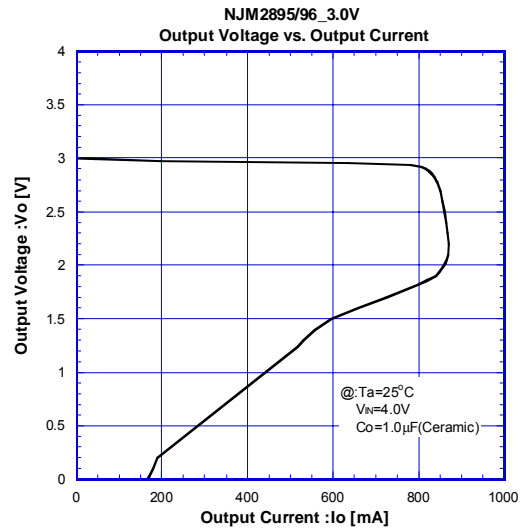
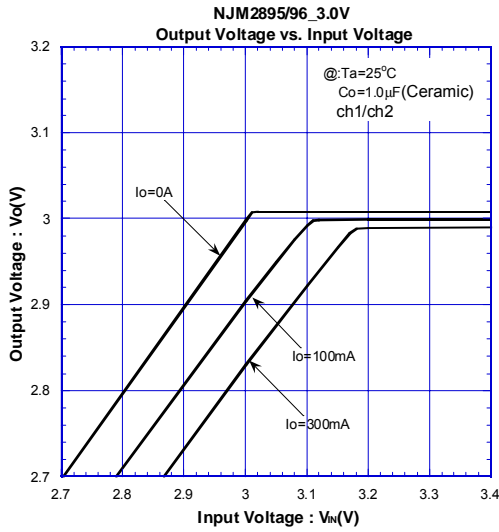

ELECTRICAL CHARACTERISTICS

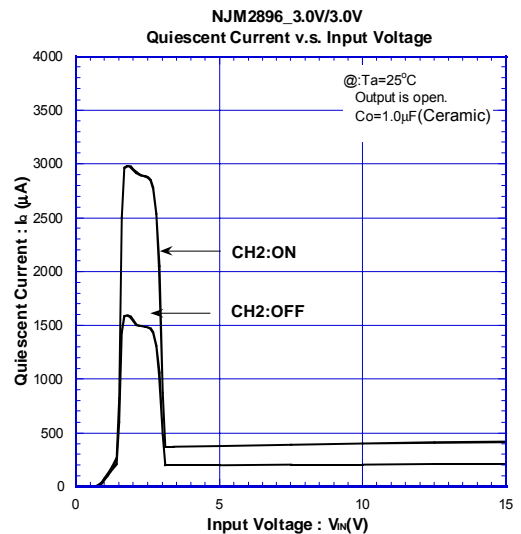
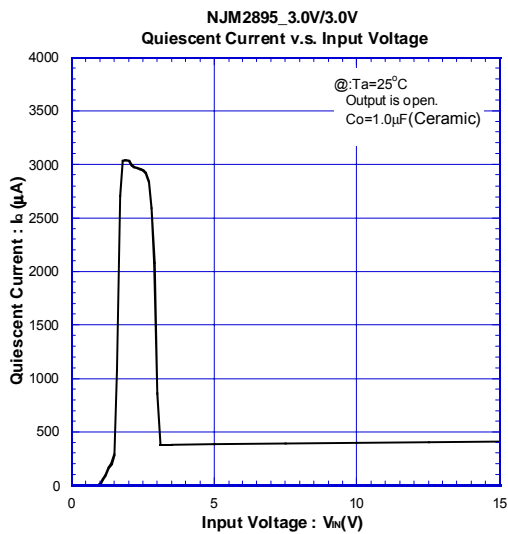
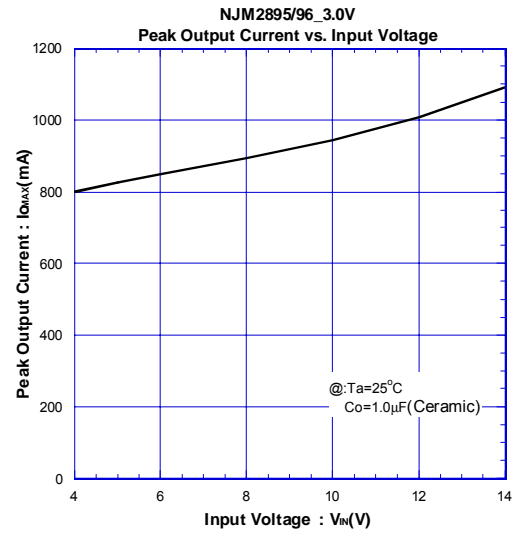
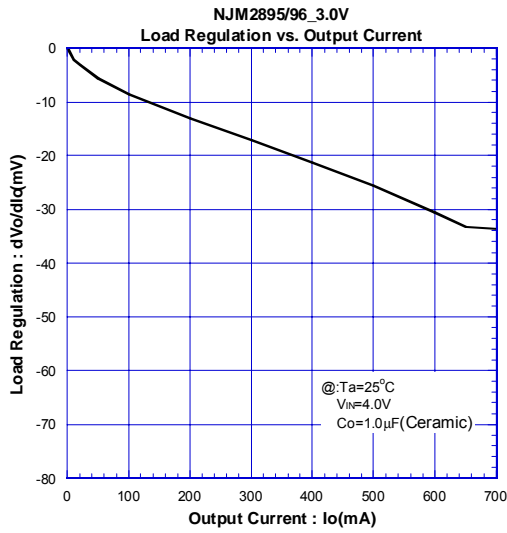
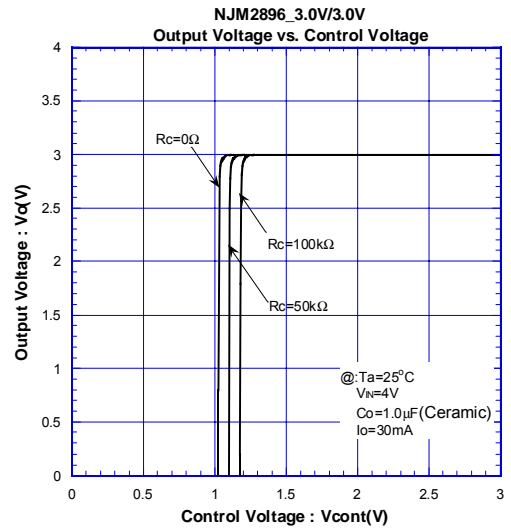
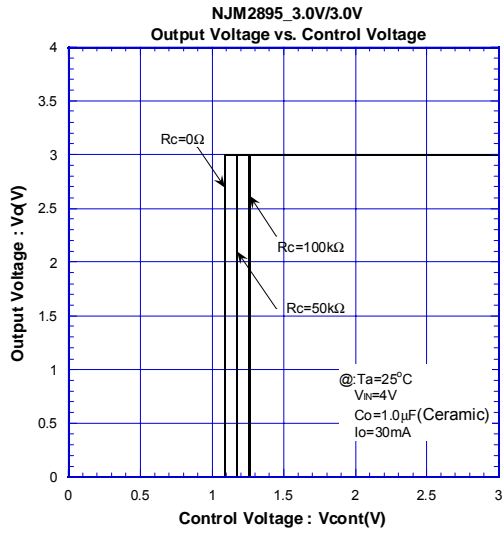

ELECTRICAL CHARACTERISTICS

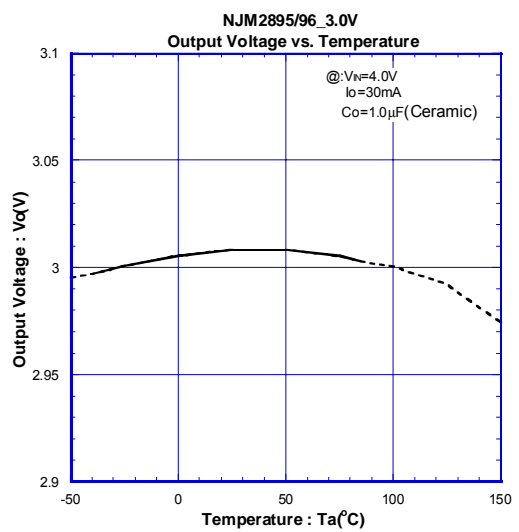
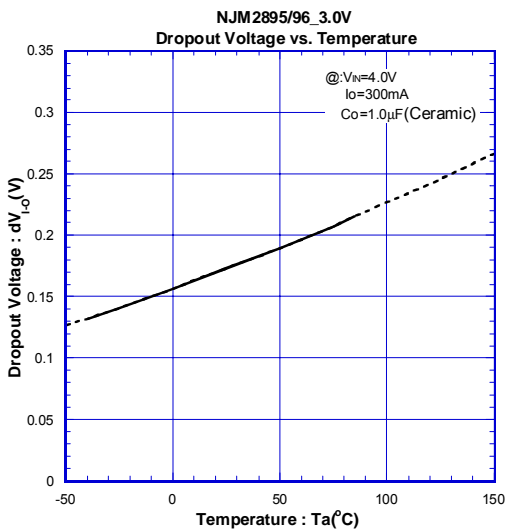
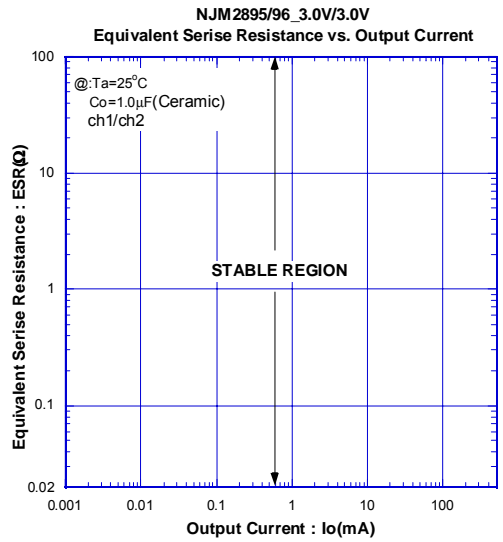
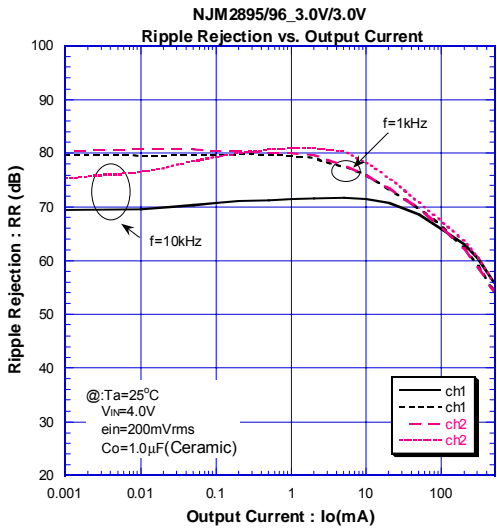
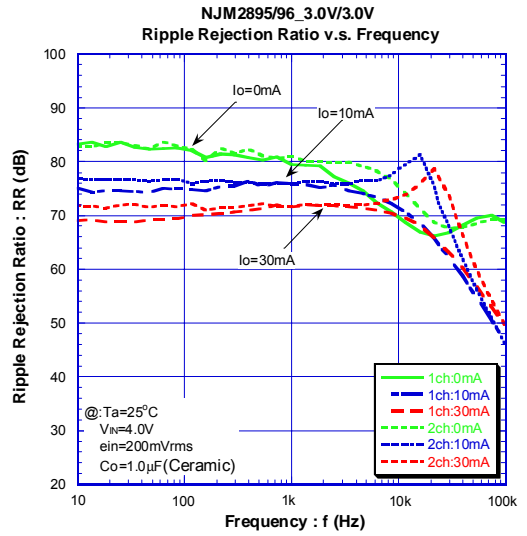
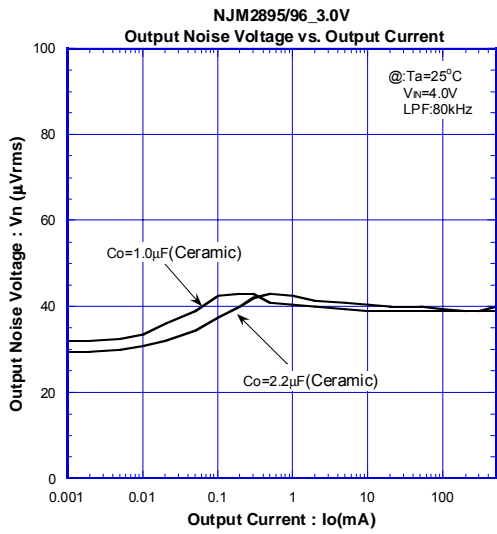

NJM2895/96

www.DataSheet4U.com

ELECTRICAL CHARACTERISTICS

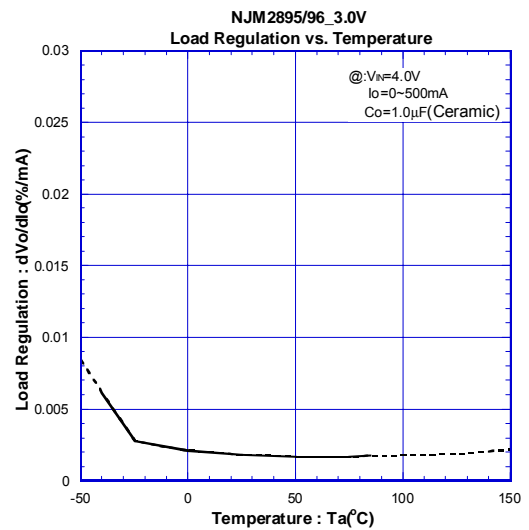
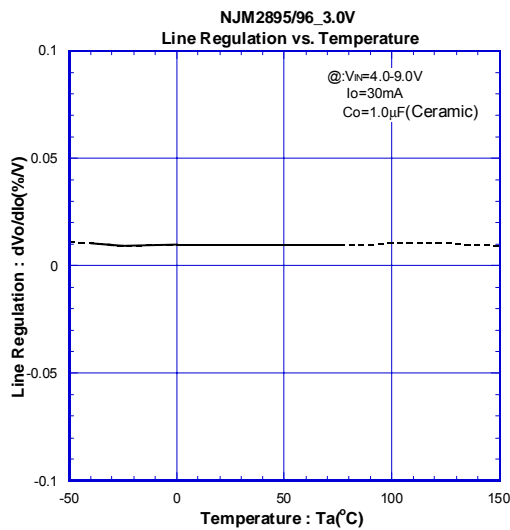
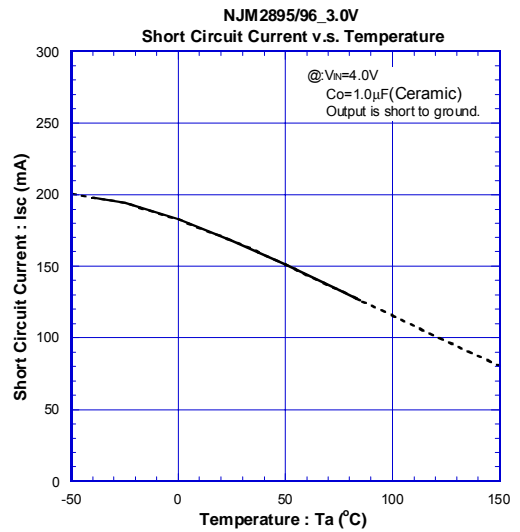
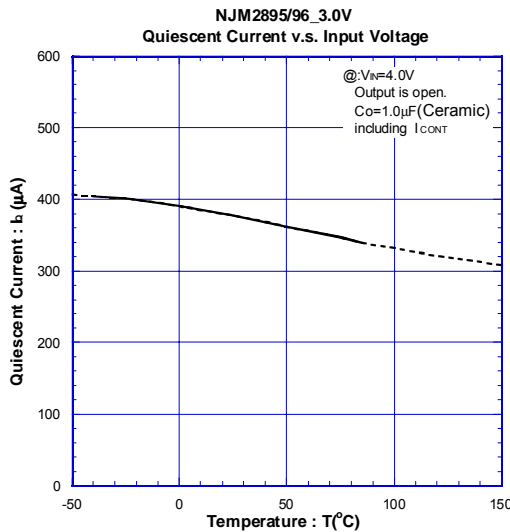
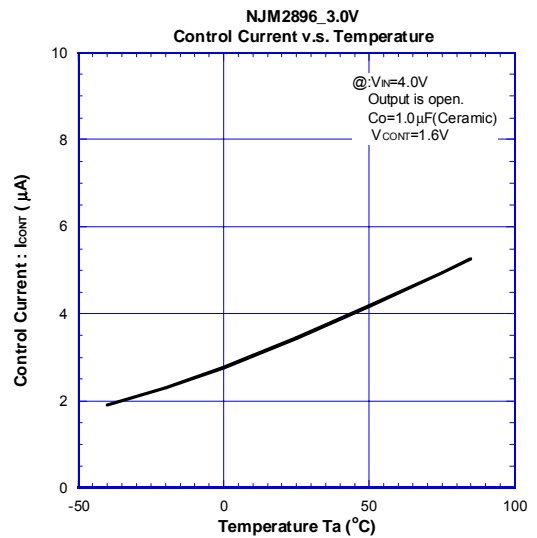
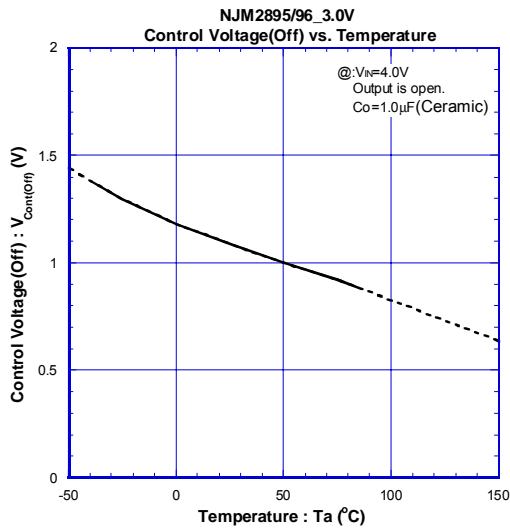

■ ELECTRICAL CHARACTERISTICS

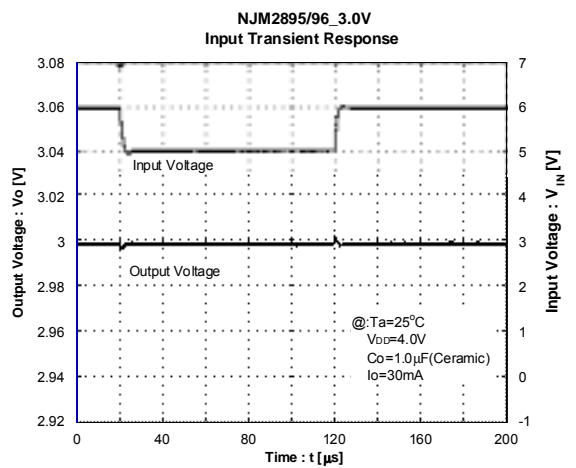
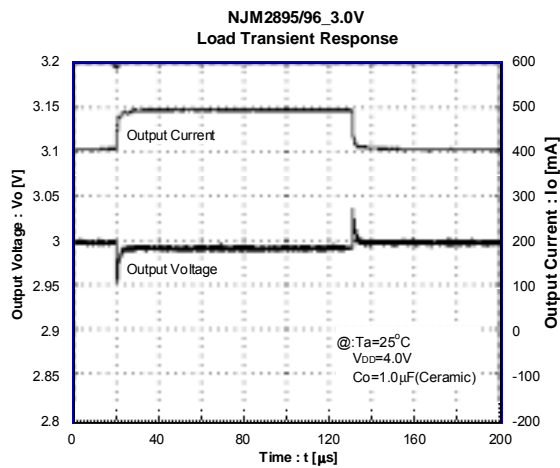
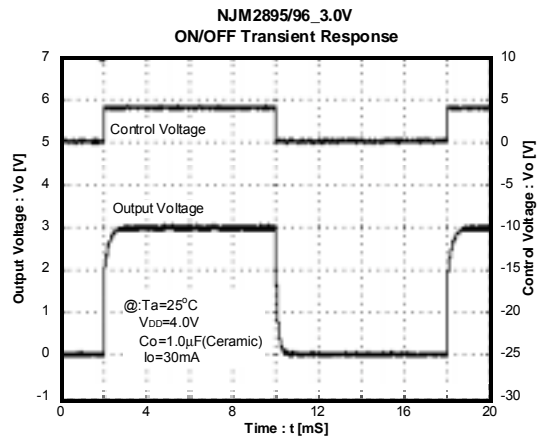
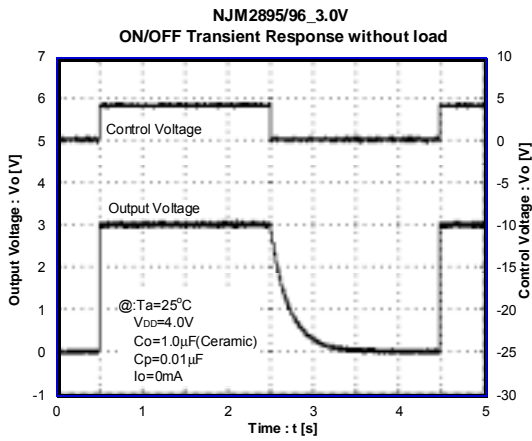
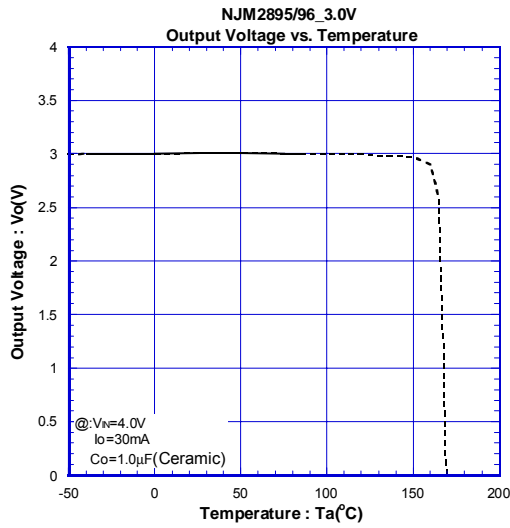

[CAUTION]
The specifications on this databook are only given for information, without any guarantee as regards either mistakes or omissions. The application circuits in this databook are described only to show representative usages of the product and not intended for the guarantee or permission of any right including the industrial rights.