

SINGLE-SUPPLY QUAD COMPARATOR

■ GENERAL DESCRIPTION

The NJM2901C / NJM2901CA consist of four independent voltage comparators that are designed specifically to operate from a single power supply over a wide range of voltages. Operation from split power supplies is also possible and the low power supply current drain is independent of the magnitude of the power supply voltage. The NJM2901C / NJM2901CA has a unique characteristic: the input common-mode voltage range includes ground, even though operated from a single power supply voltage. Application areas include limit comparators, simple analog-to-digital converters; pulse, square-wave and time delay generators; wide range V_{CO} ; MOS clock timers; multi-vibrators and high voltage digital logic gates. The NJM2901C / NJM2901CA were designed to directly interface with TTL and MOS. When operated from both plus and minus power supplies, the NJM2901C will directly interface with MOS logic where their low power drain is a distinct advantage over standard comparators.

■ FEATURES

- Operating Voltage +2V to +36V
- Single Supply Operation
- Open Collector Output
- Package Outline SOP14, SSOP14
- Bipolar Technology
- Internal ESD protection
Human body model (HBM) $\pm 2000V$ typ.
- Wide temperature range $-40^{\circ}C$ to $+125^{\circ}C$
- Input Offset Voltage Grade

NJM2901C(Normal-Grade)	NJM2901CA(A-Grade)
5mV max.	2.5mV max.

■ PACKAGE OUTLINE

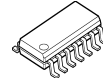

NJM2901CG
NJM2901CAG
(SOP14)



NJM2901CV
NJM2901CAV
(SSOP14)

■ PIN CONFIGURATION

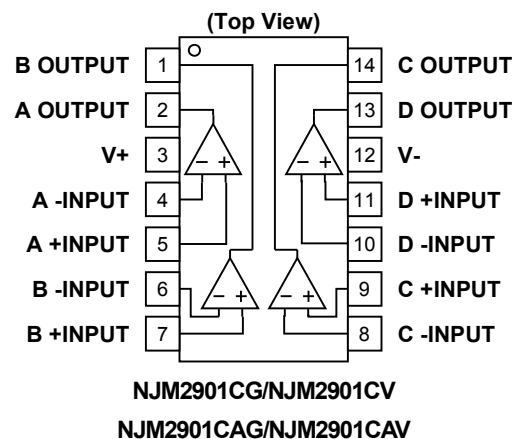

■ EQUIVALENT CIRCUIT (1/4 Shown)

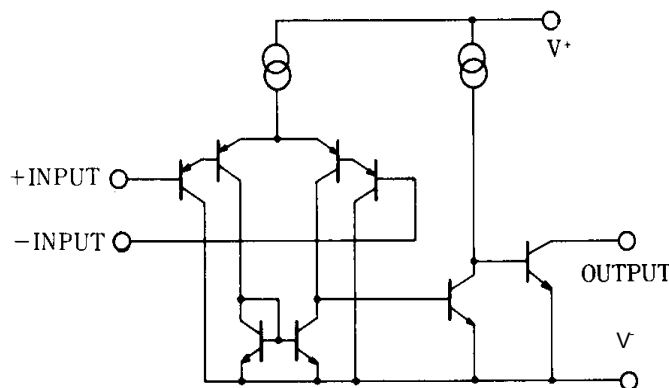

NJM2901C / NJM2901CA

■ ABSOLUTE MAXIMUM RATINGS

(Ta=25°C)

PARAMETER	SYMBOL	RATINGS	UNIT
Supply Voltage	V^+-V	+36	V
Differential Input Voltage (Note1)	V_{ID}	±36	V
Input Voltage (Note2)	V_{IN}	V -0.3 to V +36	V
Output Terminal Input Voltage (Note3)	V_O	V -0.3 to V +36	V
Power Dissipation	P_D	SOP : 880 (Note4) 1200 (Note5) SSOP : 510 (Note4) 640 (Note5)	mW
Operating Temperature Range	T_{opr}	-40 to +125	°C
Storage Temperature Range	T_{stg}	-65 to +150	°C

(Note1) It can be applied to the input terminals regardless of the supply voltage and must be less than the rating voltage.

(Note2) Input voltage is the voltage should be allowed to apply to the input terminal independent of the magnitude of V^+

(Note3) Output voltage is the voltage should be allowed to apply to the output terminal independent of the magnitude of V^+ .

(Note4) EIA/JEDEC STANDARD Test board (76.2 x 114.3 x 1.6mm, 2layers, FR-4) mounting

(Note5) EIA/JEDEC STANDARD Test board (76.2 x 114.3 x 1.6mm, 4layers, FR-4) mounting

■ ELECTRICAL CHARACTERISTICS

($V^+=5V, V^-=0V, Ta=25^\circ C$ unless otherwise noted.)

PARAMETER	SYMBOL	TEST CONDITION	MIN.	TYP.	MAX.	UNIT
Input Offset Voltage	V_{IO}	$R_S=0\Omega, V_O=1.4V$	-	0.5	5	mV
		$R_S=0\Omega, V_O=1.4V, NJM2901CA$	-	0.5	2.5	
Input Offset Current	I_{IO}		-	0.5	50	nA
Input Bias Current	I_B		-	20	250	nA
Open-Loop Voltage Gain	A_V	$V^+=15V, R_L=15k\Omega, V_O=1V$ to 11V	94	106	-	dB
Common Mode Input Voltage Range	V_{ICM}		0	-	3.5	V
Supply Current (all comparators)	I_{SUPPLY}	no load	-	0.8	2	mA
		$V^+=+30V$, no load	-	1.1	2.5	
Low-level Output Voltage	V_{OL}	$V_{IN^+}=0V, V_{IN^-}=1V, I_{SINK}=4mA$	-	160	400	mV
Output Leakage Current	I_{LEAK}	$V^+=V_O=30V, V_{IN^+}=1V, V_{IN^-}=0V$	-	-	1	uA
Output Sink Current	I_{SINK}	$V_{IN^+}=0V, V_{IN^-}=1V, V_O=1.5V$	6	16	-	mA
Response Time	t_{re}	$R_L=5.1k\Omega$ to V^+	-	1.3	-	μs
Large Signal Response Time	t_{rel}	$R_L=5.1k\Omega$ to V^+ , $V_{ref}=+1.4V$, TTL input	-	250	-	ns

TYPICAL CHARACTERISTICS

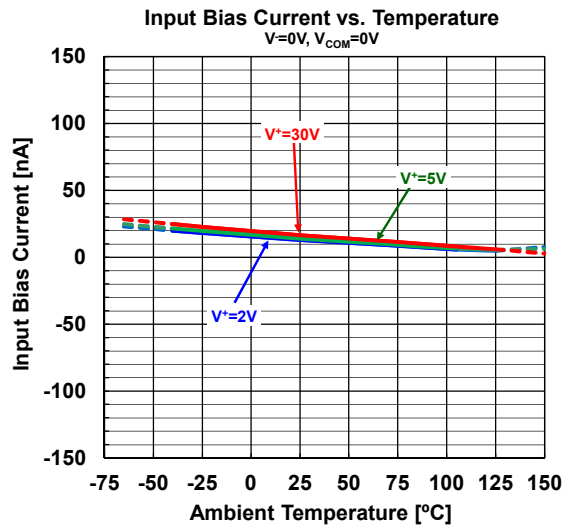
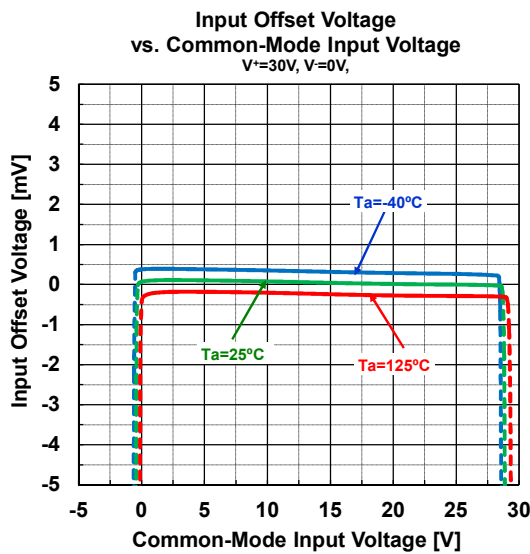
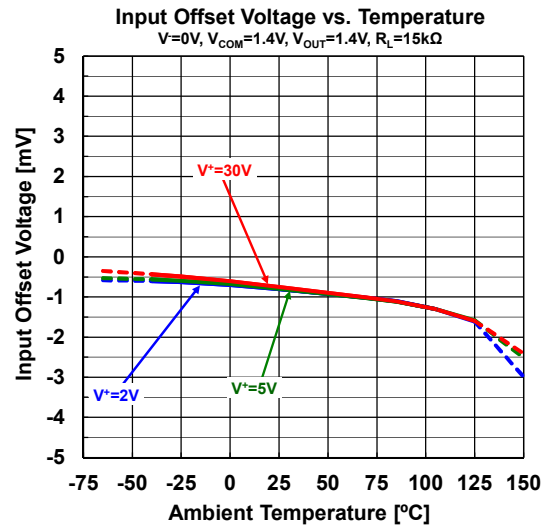
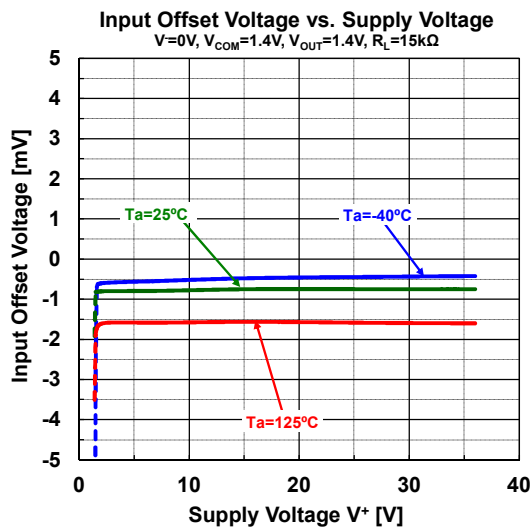
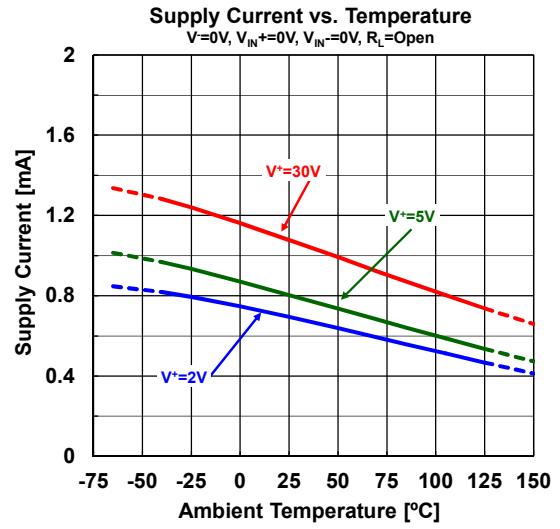
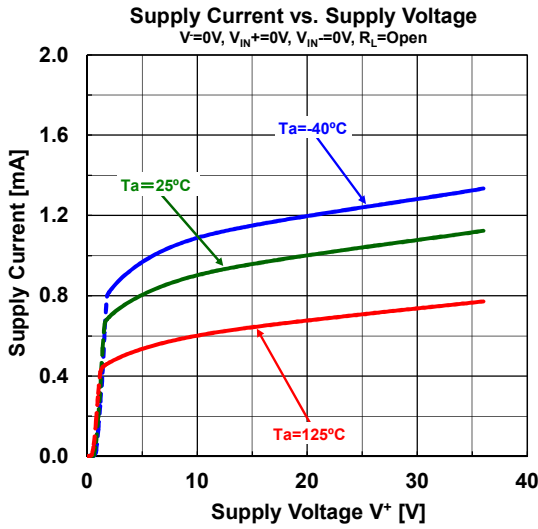

NJM2901C / NJM2901CA

TYPICAL CHARACTERISTICS

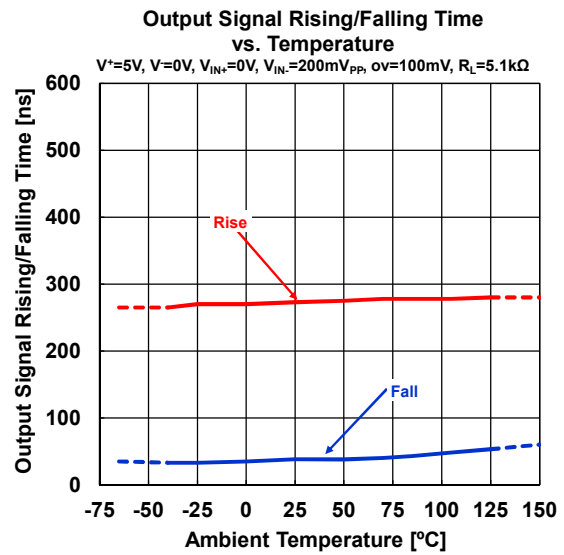
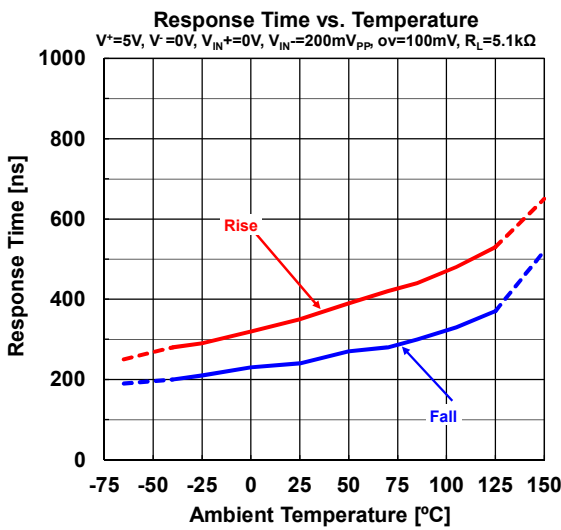
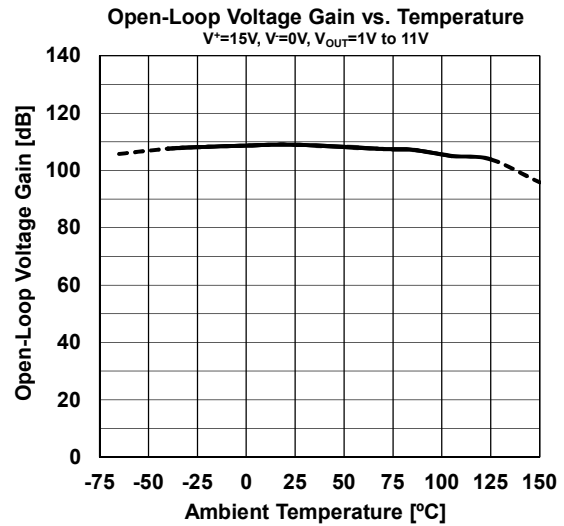
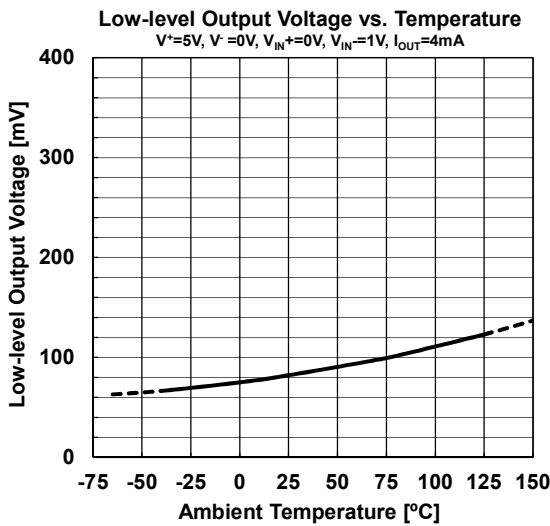
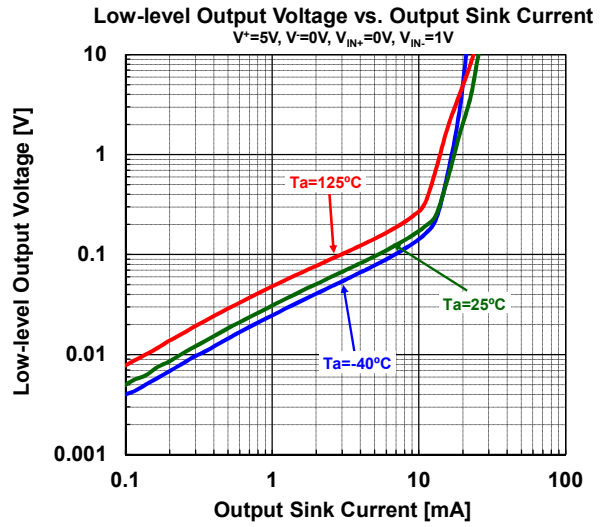
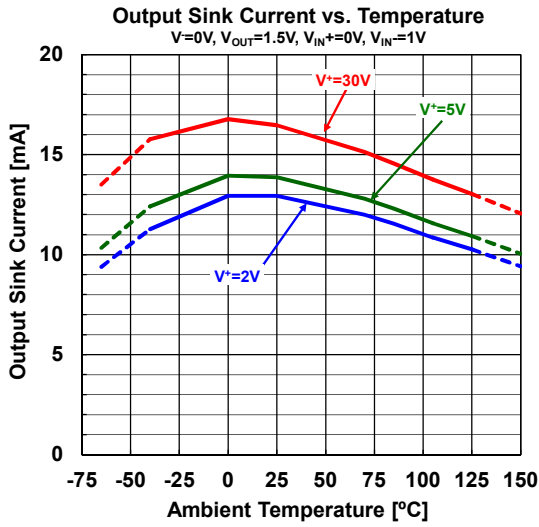

■ TYPICAL CHARACTERISTICS

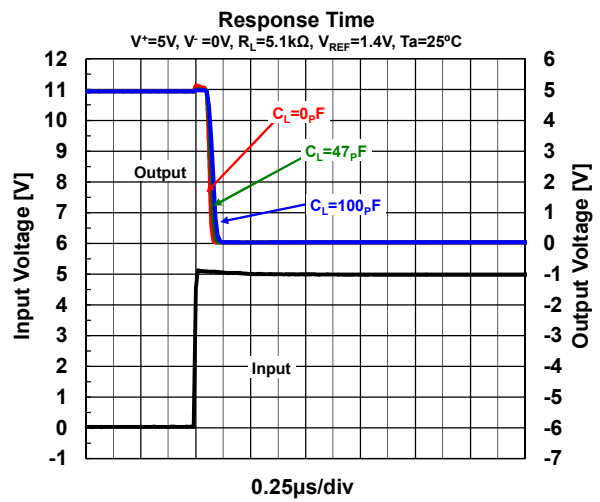
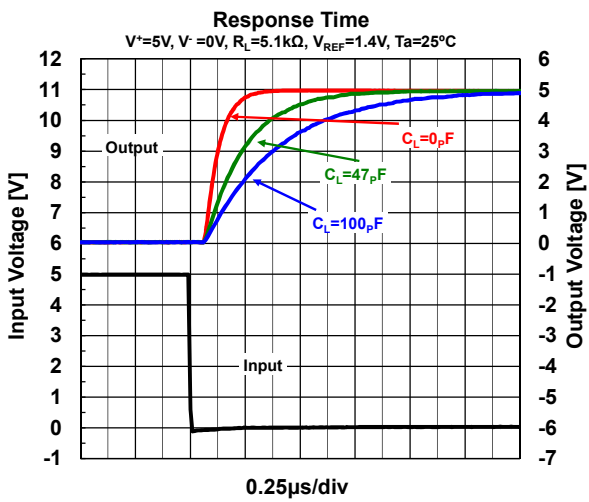
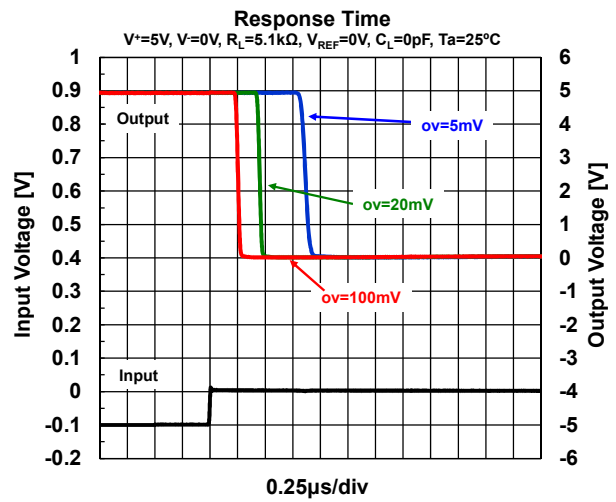
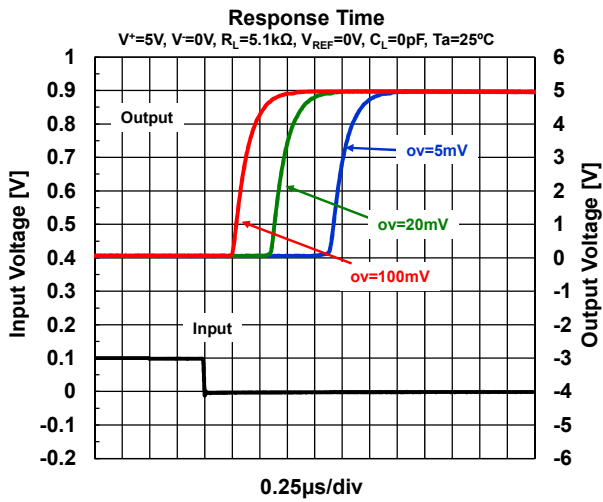

■ TYPICAL APPLICATIONS

Comparator With Hysteresis

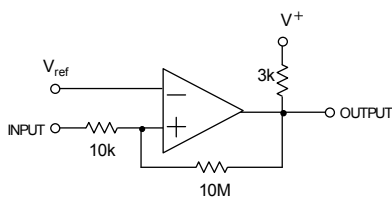

Pulse Generator

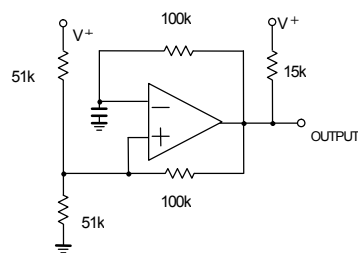

Output Strobing Circuit

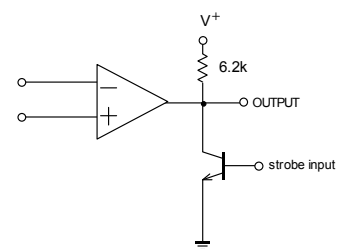

NJM2901C / NJM2901CA

PACKAGE OUTLINE UNIT : mm

SOP14

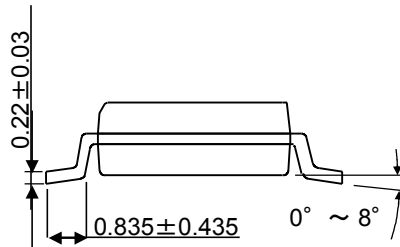
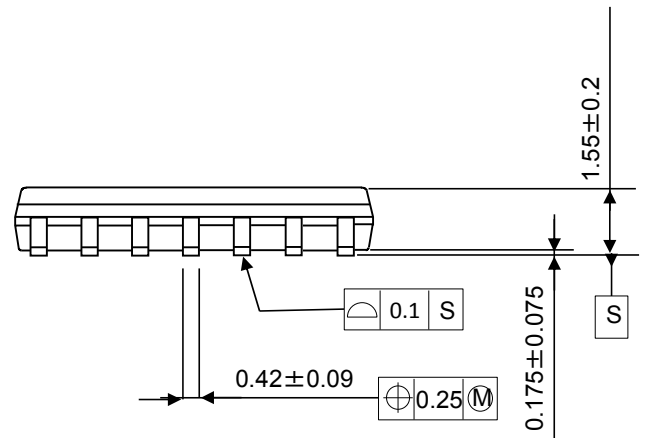
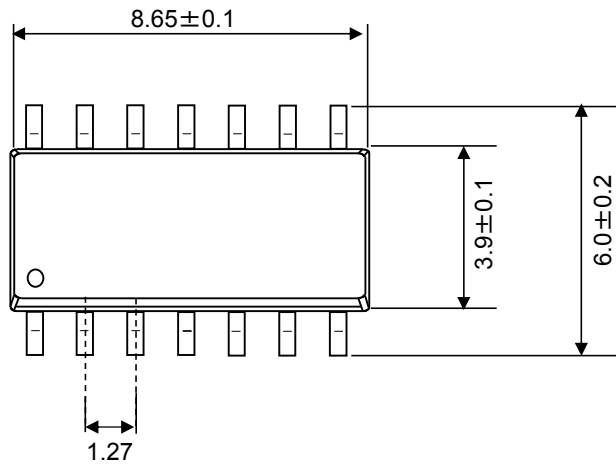

SSOP14

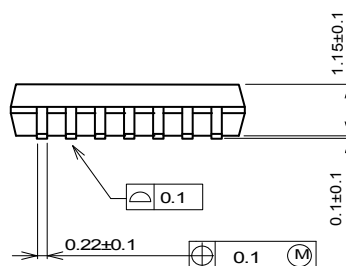
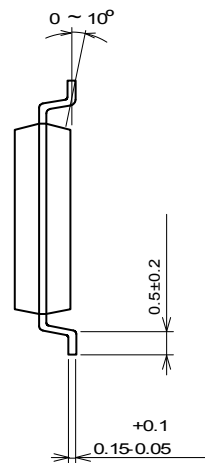
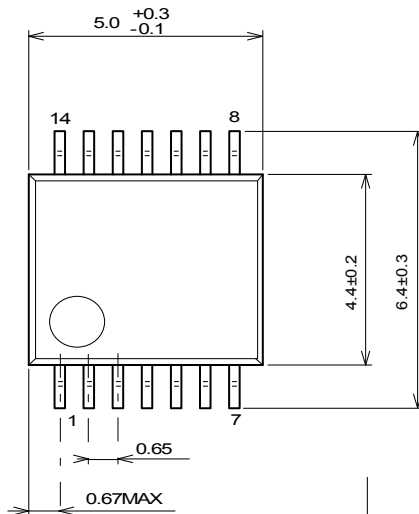

[CAUTION]

The specifications on this databook are only given for information, without any guarantee as regards either mistakes or omissions.

The application circuits in this databook are described only to show representative usages of the product and not intended for the