

## DUAL OPERATIONAL AMPLIFIER

### ■ GENERAL DESCRIPTION

NJM4580C is the dual operational amplifier, specially designed for improving the tone control, which is suitable for the audio application.

Featuring noiseless, higher gain bandwidth, high output current and low distortion ratio, and it is most suitable not only for acoustic electronic parts of audio pre-amp and active filter, but also for the industrial measurement tools. It is also suitable for the head phone amp at higher output current, and further more, it can be applied for the handy type set operational amplifier of general purpose in application of low voltage single supply type which is properly biased of the low voltage source.

### ■ FEATURES

- Operating Voltage             $\pm 2V$  to  $\pm 18V$
- Low Input Noise Voltage     $5nV/\sqrt{\text{Hz}}$  typ. at  $f=1\text{kHz}$
- Gain Bandwidth Product     $15\text{MHz}$  typ.
- Low Distortion                 $0.0005\%$  typ.
- Slew Rate                         $5V/\mu\text{s}$  typ.
- Bipolar Technology
- Package Outline                SOP8, SSOP8
- Internal ESD protection  
Human body model (HBM)  $\pm 2000V$  typ.

### ■ PACKAGE OUTLINE



### ■ PIN CONFIGURATION

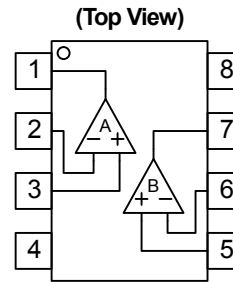

- PIN FUNCTION**
- 1.A OUTPUT
  - 2.A -INPUT
  - 3.A +INPUT
  - 4.V<sup>-</sup>
  - 5.B +INPUT
  - 6.B -INPUT
  - 7.B OUTPUT
  - 8.V<sup>+</sup>

NJM4580CG  
NJM4580CV

### ■ EQUIVALENT CIRCUIT ( 1/2 Shown )

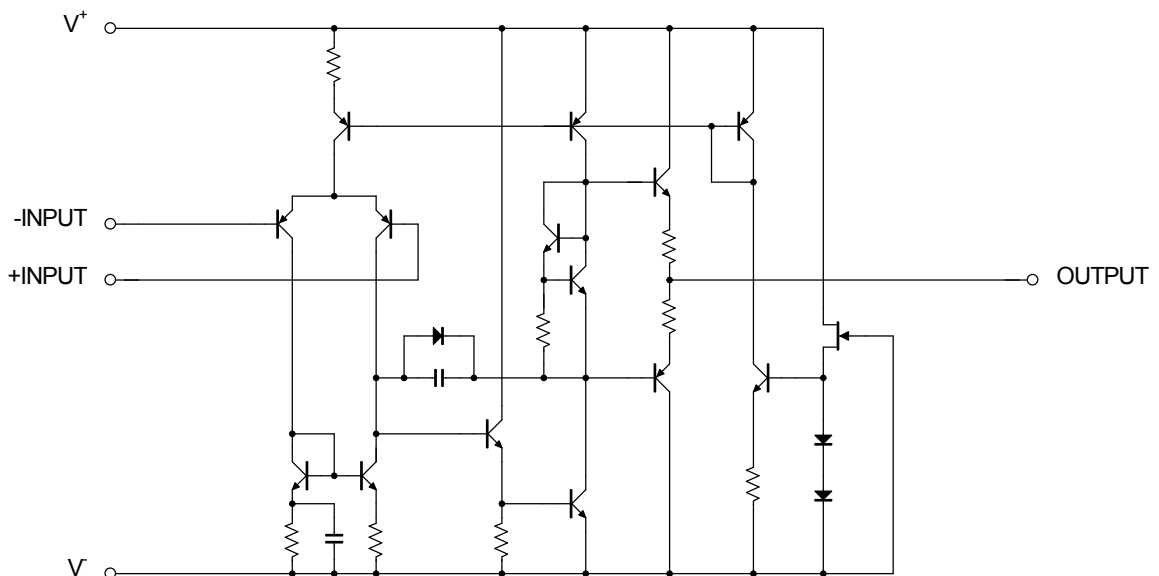

# NJM4580C

## ■ ABSOLUTE MAXIMUM RATINGS (Ta=25°C, unless otherwise noted.)

PARAMETER	SYMBOL	RATING	UNIT
Supply Voltage	V <sup>+</sup> /V <sup>-</sup>	±18	V
Differential Input Voltage (Note1) (Note2)	V <sub>ID</sub>	±36	V
Input Voltage (Note2)	V <sub>IC</sub>	±18	V
Power Dissipation	P <sub>D</sub>	SOP : 550 (Note3) 820(Note4) SSOP : 350 (Note3) 440(Note4)	mW
Operating Temperature Range	Topr	-40~+85	°C
Storage Temperature Range	Tstg	-65~+125	°C

(Note1) Differential voltage is the voltage difference between +INPUT and -INPUT.

(Note2) For supply voltage less than ±15V, the absolute maximum rating is equal to the supply voltage.

The normal operation will establish when any input is within the Common Mode Input Voltage Range of electrical characteristics.

(Note3) EIA/JEDEC STANDARD Test board (76.2 x 114.3 x 1.6mm, 2layers, FR-4) mounting

(Note4) EIA/JEDEC STANDARD Test board (76.2 x 114.3 x 1.6mm, 4layers, FR-4) mounting

## ■ RECOMMENDED OPERATING CONDITIONS (Ta=25°C)

PARAMETER	SYMBOL	CONDITION	MIN.	TYP.	MAX.	UNIT
Supply Voltage	V <sup>+</sup> /V <sup>-</sup>		±2	-	±18	V

## ■ ELECTRICAL CHARACTERISTICS (V<sup>+</sup>/V<sup>-</sup> = ±15V, Ta=25°C, unless otherwise noted.)

PARAMETER	SYMBOL	TEST CONDITION	MIN.	TYP.	MAX.	UNIT
Input Offset Voltage	V <sub>IO</sub>	R <sub>S</sub> ≤10kΩ	-	0.3	3	mV
Input Offset Current	I <sub>IO</sub>		-	5	200	nA
Input Bias Current	I <sub>B</sub>		-	100	500	nA
Input Resistance	R <sub>IN</sub>		-	0.5	-	MΩ
Large Signal Voltage Gain	A <sub>V</sub>	R <sub>L</sub> ≥2kΩ, V <sub>O</sub> =±10V	90	110	-	dB
Maximum Output Voltage	V <sub>OM</sub>	R <sub>L</sub> ≥2kΩ	±12	±13.5	-	V
Common Mode Input Voltage Range	V <sub>ICM</sub>		±12	±13.5	-	V
Common Mode Rejection Ratio	CMR	R <sub>S</sub> ≤10kΩ	80	110	-	dB
Supply Voltage Rejection Ratio	SVR	R <sub>S</sub> ≤10kΩ	80	110	-	dB
Supply Current	I <sub>CC</sub>		-	6	9	mA
Slew Rate	SR	R <sub>L</sub> ≥2kΩ	-	5	-	V/μs
Gain Bandwidth Product	GBP	f=10kHz	-	15	-	MHz
Total Harmonic Distortion	THD	A <sub>V</sub> =20dB, V <sub>O</sub> =5V, R <sub>L</sub> =2kΩ, f=1kHz	-	0.0005	-	%
Equivalent Input Noise Voltage1	V <sub>NI</sub>	RIAA, R <sub>S</sub> =2.2kΩ, 30kHz LPF	-	0.8	-	μVrms
Equivalent Input Noise Voltage2	e <sub>n</sub>	f=1kHz	-	5	-	nV/√Hz

## ■ TYPICAL CHARACTERISTICS

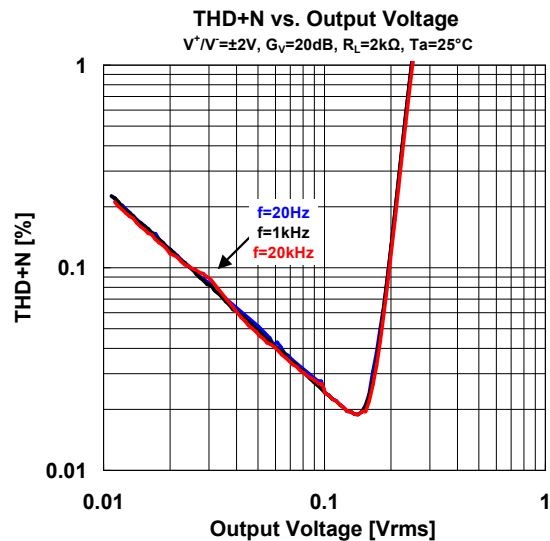
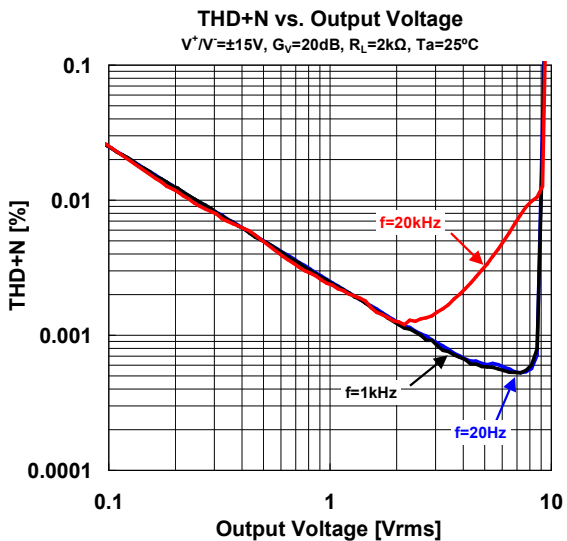
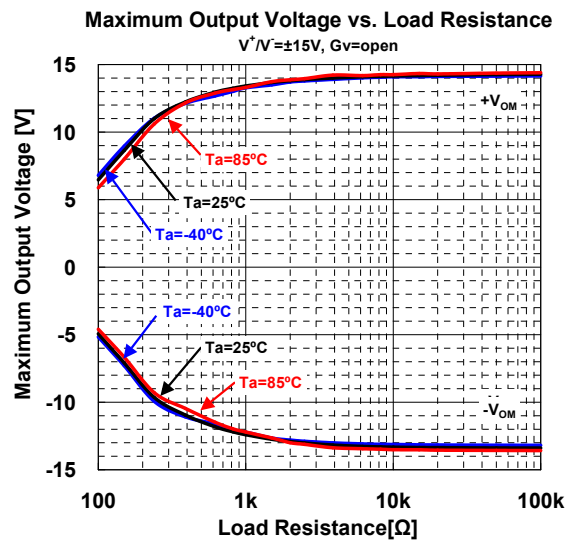
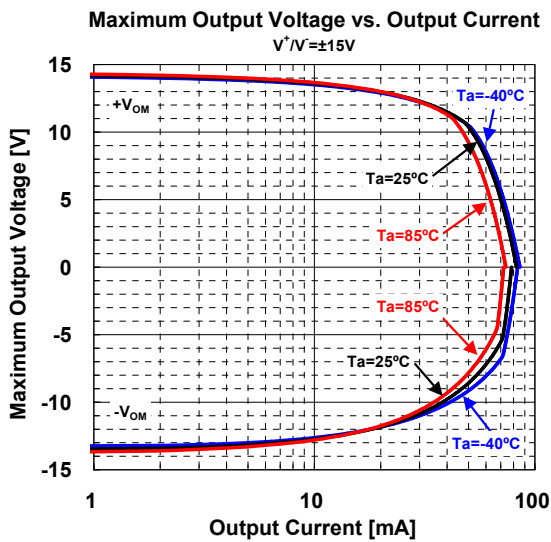
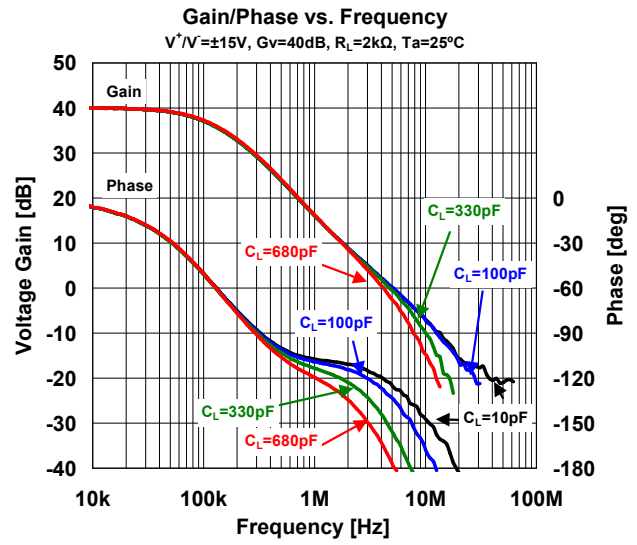
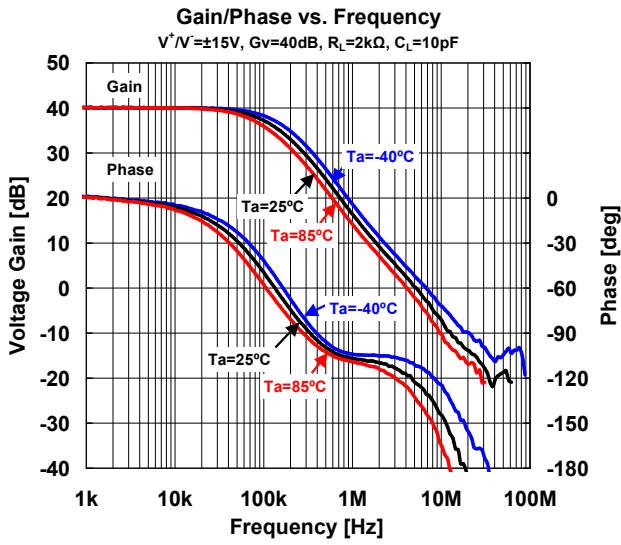

# NJM4580C

## ■ TYPICAL CHARACTERISTICS

Maximum Output Voltage Swing vs. Frequency  
 $V^+/V^- = \pm 15V$ ,  $R_L = 2k\Omega$ ,  $T_a = 25^\circ C$

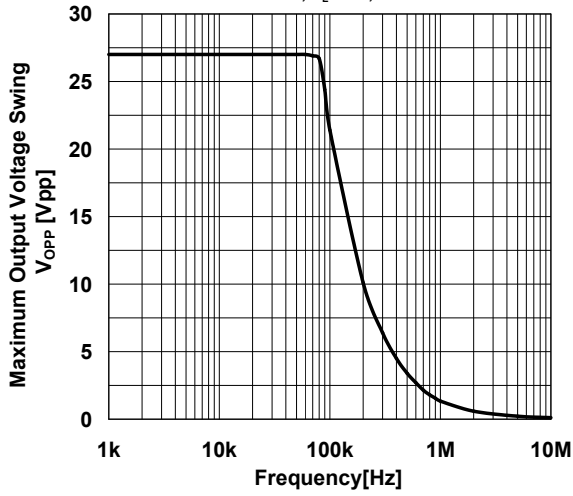

Voltage Noise vs. Frequency  
 $V^+/V^- = \pm 15V$ ,  $G_V = 40dB$ ,  $R_T = 2k\Omega$

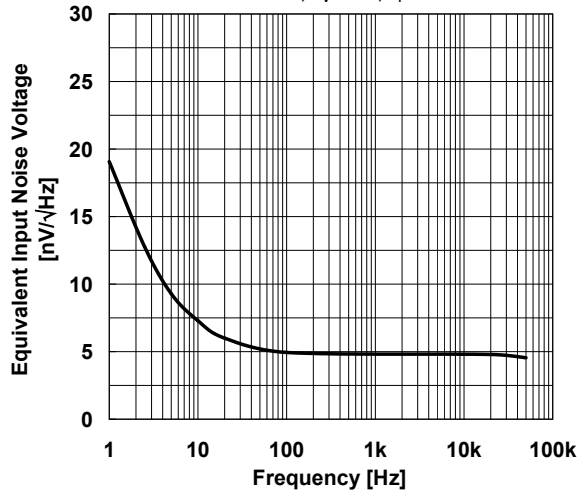

Supply Current vs. Supply Voltage  
 $R_L = open$

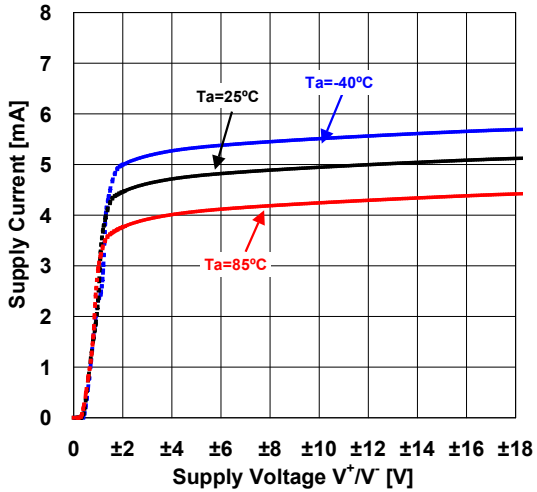

Supply Current vs. Temperature  
 $R_L = open$

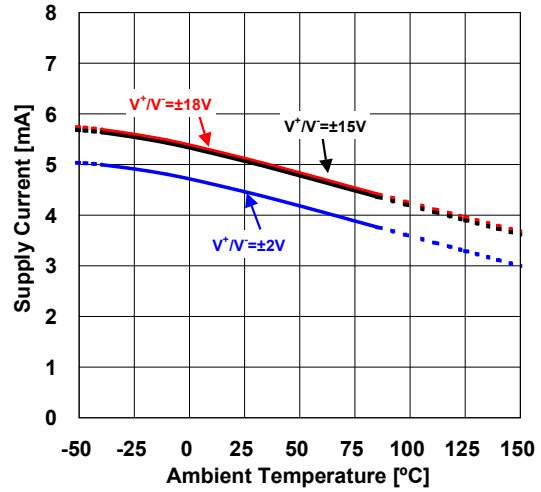

Input Offset Voltage vs. Temperature

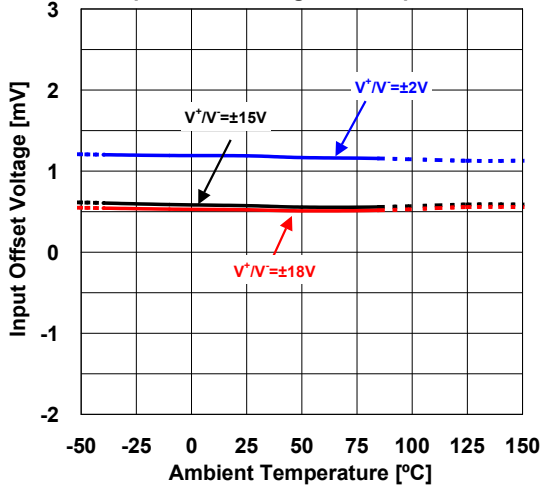

Input Offset Voltage vs. Supply Voltage

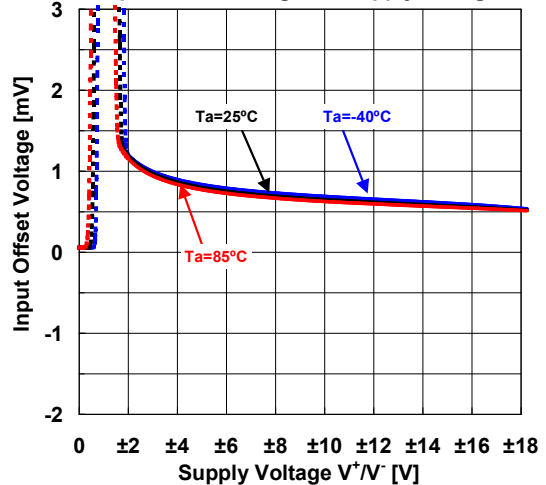

## ■ TYPICAL CHARACTERISTICS

Input Offset Voltage  
vs. Common-Mode Input Voltage  
 $V^+/V^-=\pm 15V$

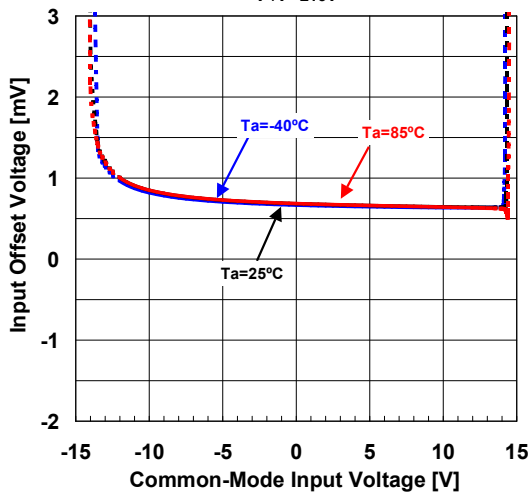

Input Offset Voltage  
vs. Common-Mode Input Voltage  
 $V^+/V^-=\pm 2V$

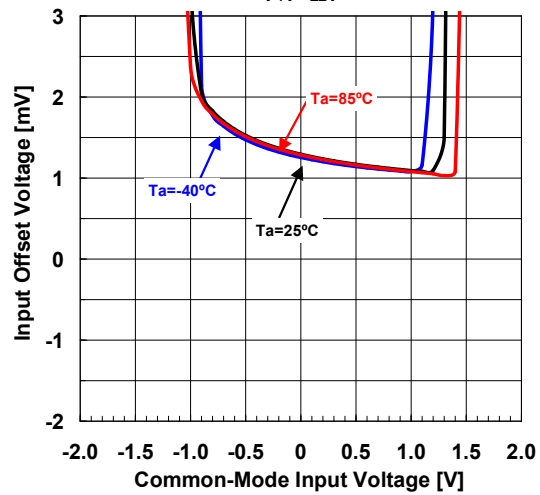

Input Bias Current vs. Temperature  
 $V_{ICM}=0V$

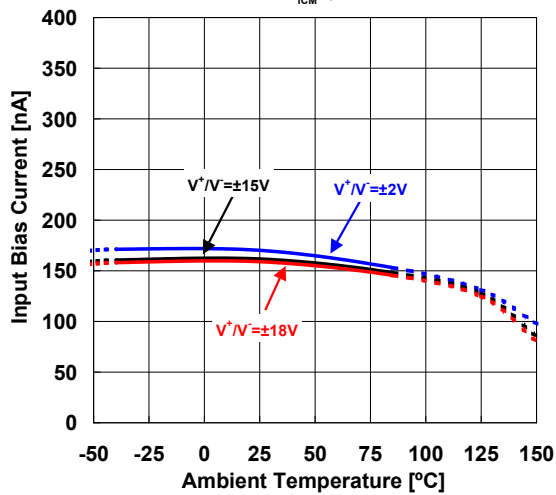

Large Signal Voltage Gain vs. Temperature  
 $V^+/V^-=\pm 15V, R_i=2k\Omega$  to GND

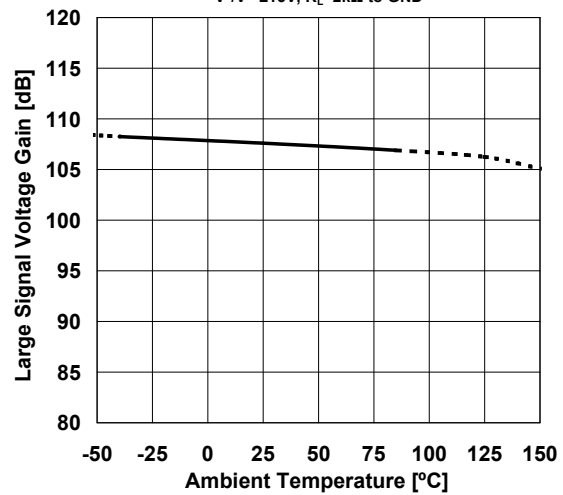

CMR vs. Temperature  
 $V^+/V^-=\pm 15V, V_{CM}=-12.2V\sim 12.2V$

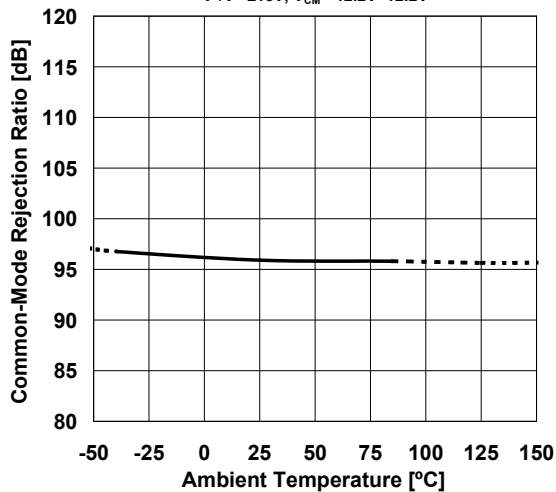

SVR vs. Temperature  
 $V^+/V^-=\pm 9V \rightarrow \pm 18V$

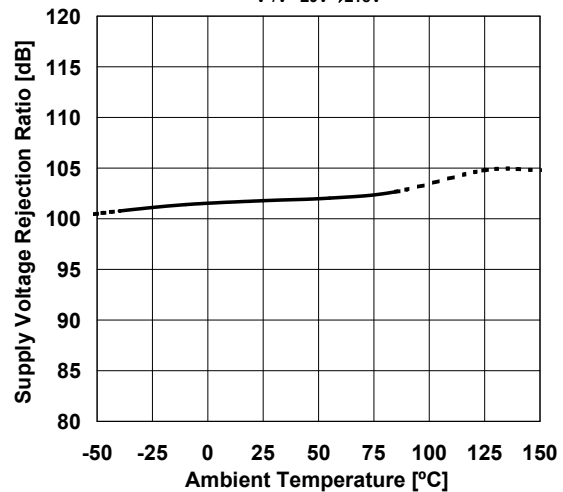

# NJM4580C

## ■ TYPICAL CHARACTERISTICS

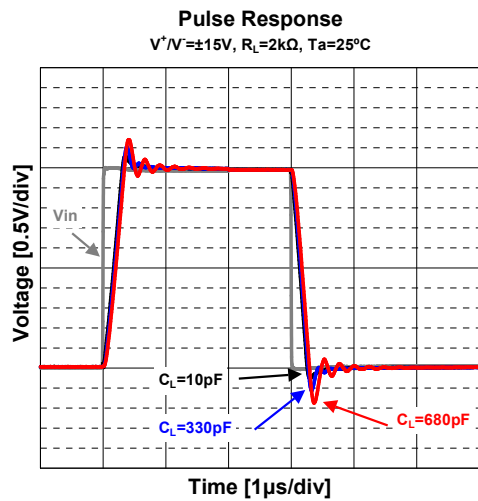
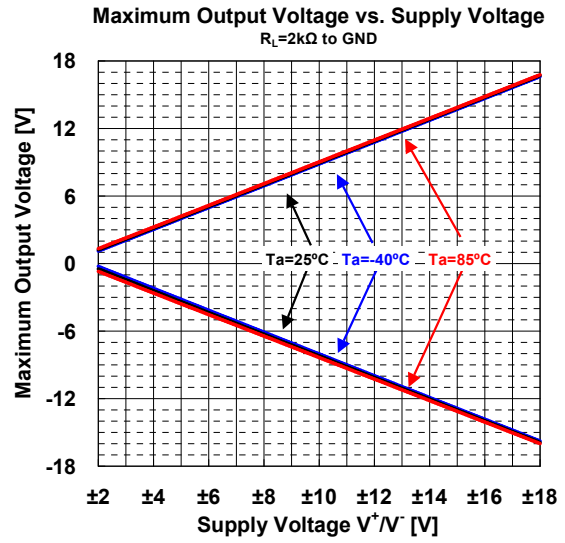
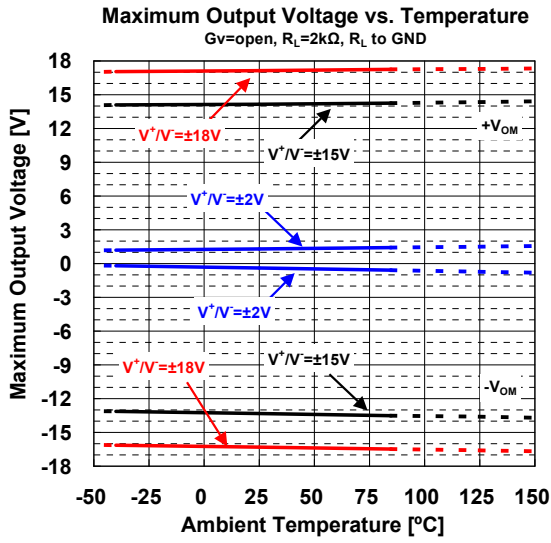

## ■PACKAGE OUTLINE UNIT : mm

### SOP8

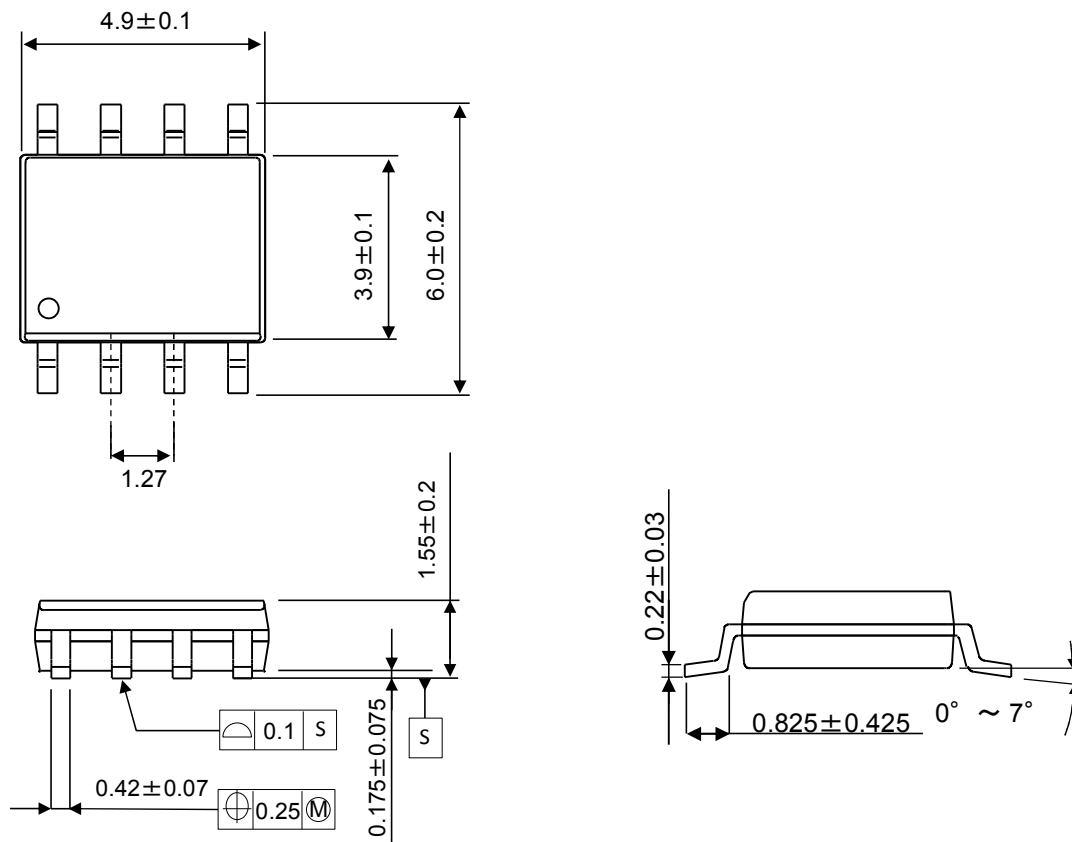

### SSOP8

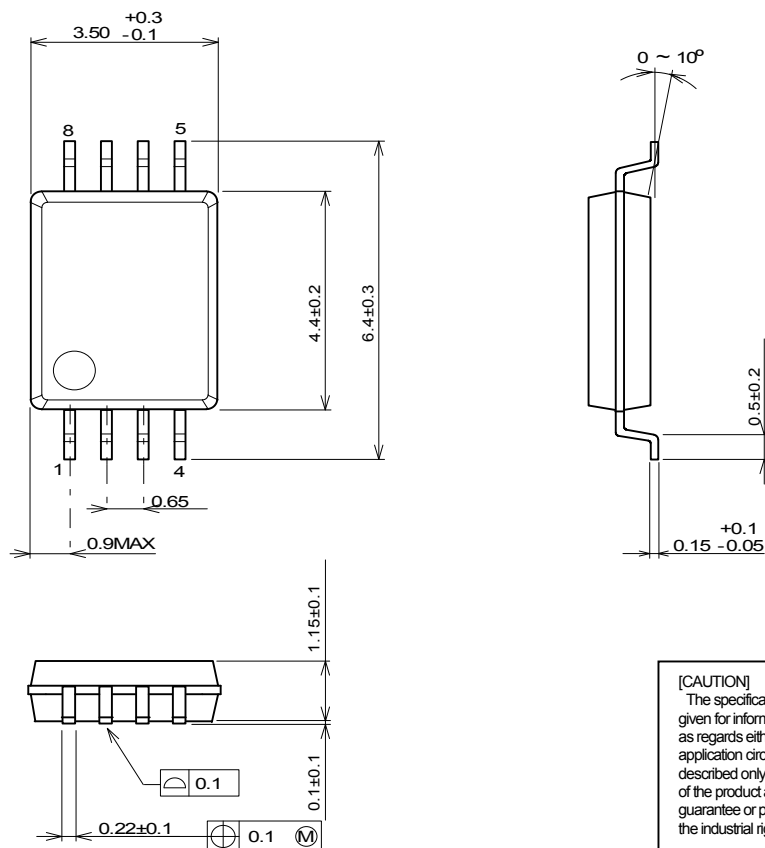

**[CAUTION]**  
 The specifications on this databook are only given for information, without any guarantee as regards either mistakes or omissions. The application circuits in this databook are described only to show representative usages of the product and not intended for the guarantee or permission of any right including the industrial rights.