

AUDIO DUAL OPERATIONAL AMPLIFIER

■ GENERAL DESCRIPTION

NJM4582 is the dual operational amplifier, specially designed for improving the tone control, which is most suitable for the audio application.

Featuring noiseless, higher gain bandwidth, high output current and low distortion ratio, and it is most suitable not only for acoustic electronic parts of audio pre-amp and active filter, but also for the industrial measurement tools. It is also suitable for the head phone amp at higher output current, and further more, it can be applied for the handy type set operational amplifier of general purpose in application of low voltage single supply type which is properly biased of the low voltage source.

■ PACKAGE OUTLINE



**NJM4582VA3
(SSOP8-A3)**

■ FEATURES

- Operating Voltage $\pm 2V \sim \pm 18V$
- Low Input Noise Voltage $0.8\mu V_{rms}$ typ. (RIAA)
- Wide GBW 15MHz typ.
- Low Distortion 0.0005% typ.
- Slew Rate $5V/\mu s$ typ.
- Bipolar Technology
- Package Outline SSOP8-A3

■ PIN CONFIGURATION

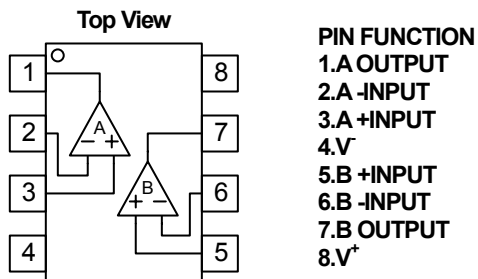

■ EQUIVALENT CIRCUIT (1/2 Shown)

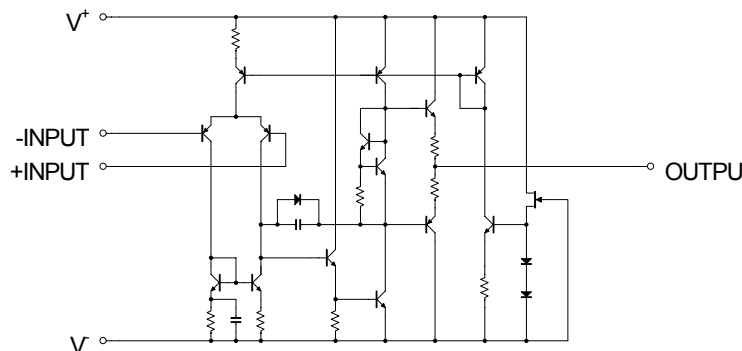

NJM4582

■ ABSOLUTE MAXIMUM RATINGS (Ta=25°C, unless otherwise noted.)

PARAMETER	SYMBOL	RATING	UNIT
Supply Voltage	V ⁺ V	±18	V
Common Mode Input Voltage Range	V _{ICM}	±15 (Note1)	V
Differential Input Voltage Range	V _{ID}	±30 (Note1)	V
Power Dissipation	P _D	460 (Note2) 600 (Note 3)	mW
Operating Temperature Range	Topr	-40~+85	°C
Storage Temperature Range	Tstg	-40~+125	°C

(Note1) For supply voltage less than ±15V, the absolute maximum input voltage is equal to supply voltage.

(Note2) On the PCB "EIA/JEDEC (114.3×76.2×1.6mm, 2 layers, FR-4)"

(Note3) On the PCB "EIA/JEDEC (114.3×76.2×1.6mm, 4 layers, FR-4)"

■ RECOMMENDED OPERATING CONDITIONS (Ta=25°C)

PARAMETER	SYMBOL	CONDITION	MIN.	TYP.	MAX.	UNIT
Supply Voltage	V ⁺ V		±2	-	±18	V

■ ELECTRICAL CHARACTERISTICS (V⁺V=±15V, Ta=25°C, unless otherwise noted.)

PARAMETER	SYMBOL	TEST CONDITION	MIN.	TYP.	MAX.	UNIT
Input Offset Voltage	V _{IO}	R _S ≤10kΩ	-	0.3	3	mV
Input Offset Current	I _{IO}		-	5	200	nA
Input Bias Current	I _B		-	100	500	nA
Voltage Gain	A _V	R _L ≥2kΩ, V _O =±10V	90	110	-	dB
Maximum Output Voltage	V _{OM}	R _L ≥2kΩ	±12	±13.5	-	V
Common Mode Input Voltage Range	V _{ICM}		±12	±13.5	-	V
Common Mode Rejection Ratio	CMR	R _S ≤10kΩ	80	110	-	dB
Supply Voltage Rejection Ratio	SVR	R _S ≤10kΩ	80	110	-	dB
Supply Current	I _{CC}		-	6	9	mA
Slew Rate	SR	R _L ≥2kΩ	-	5	-	V/μs
Gain Bandwidth Product	GB	f=10kHz	-	15	-	MHz
Total Harmonic Distortion	THD	A _V =20dB, V _O =5V, R _L =2kΩ, f=1kHz	-	0.0005	-	%
Equivalent Input Noise Voltage	V _{NI}	RIAA, R _S =2.2kΩ, 30kHz LPF	-	0.8	-	μVrms

■ TYPICAL CHARACTERISTICS

40dB Gain/Phase vs. Frequency
 $V^+/V^-=\pm 15V, R_L=2k\Omega, T_a=25^\circ C$

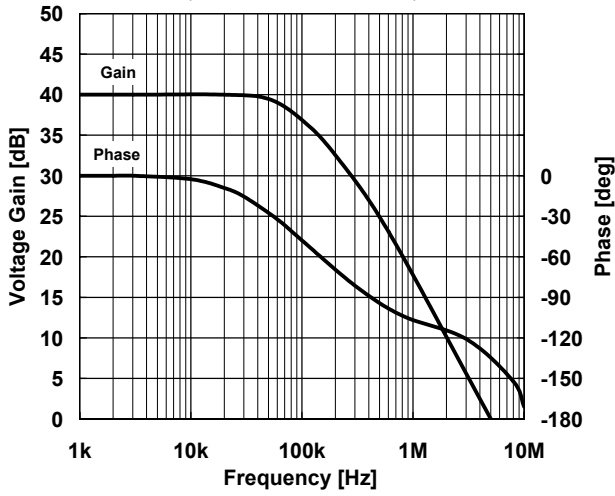

Maximum Output Voltage vs. Frequency
 $V^+/V^-=\pm 15V, R_L=2k\Omega, T_a=25^\circ C$

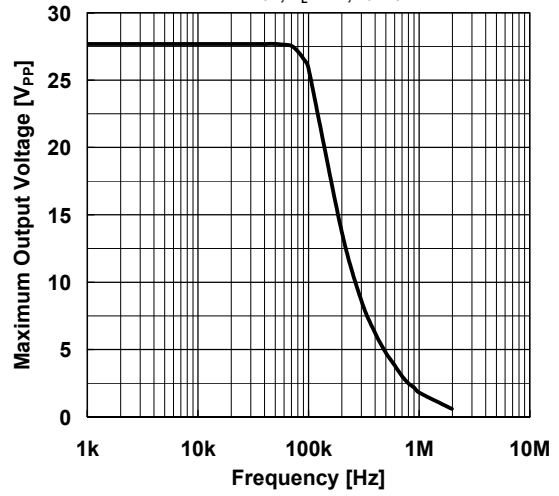

Maximum Output Voltage vs. Output Current
 $V^+/V^-=\pm 15V, T_a=25^\circ C$

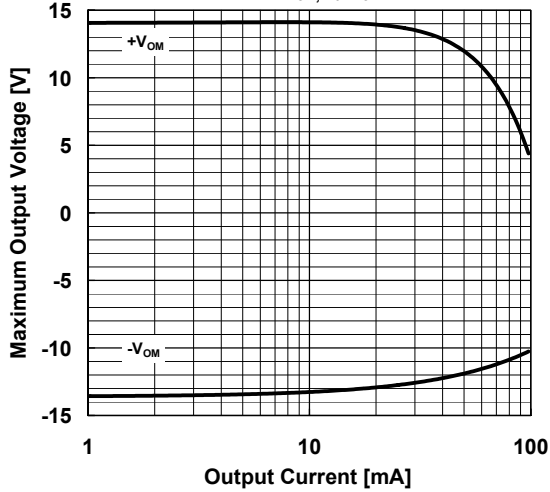

Maximum Output Voltage vs. Load Resistance
 $V^+/V^-=\pm 15V, T_a=25^\circ C$

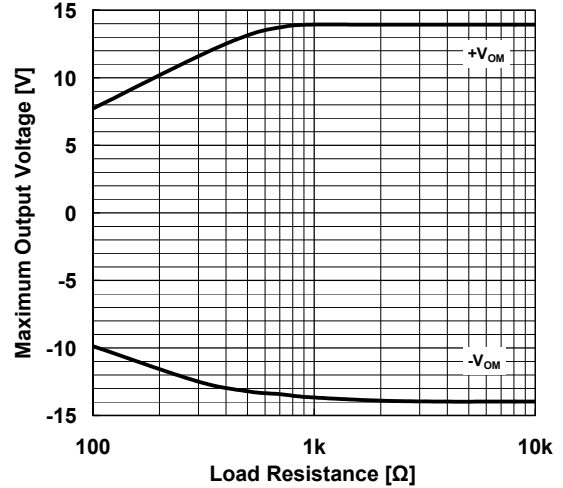

THD+N vs. Output Voltage (Frequency)
 $V^+/V^-=\pm 15V, G_v=20dB, R_L=2k\Omega$

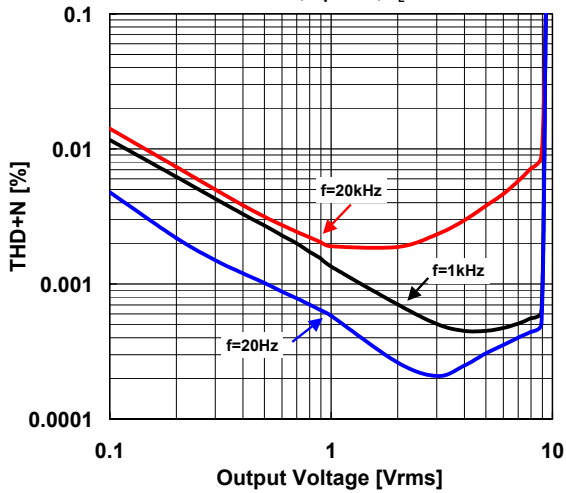

Voltage Noise vs. Frequency
 $V^+/V^-=\pm 15V, R_g=50\Omega, G_v=60dB, T_a=25^\circ C$

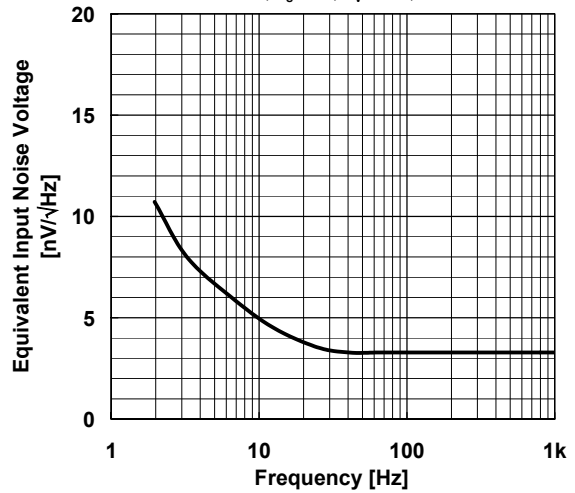

■ TYPICAL CHARACTERISTICS

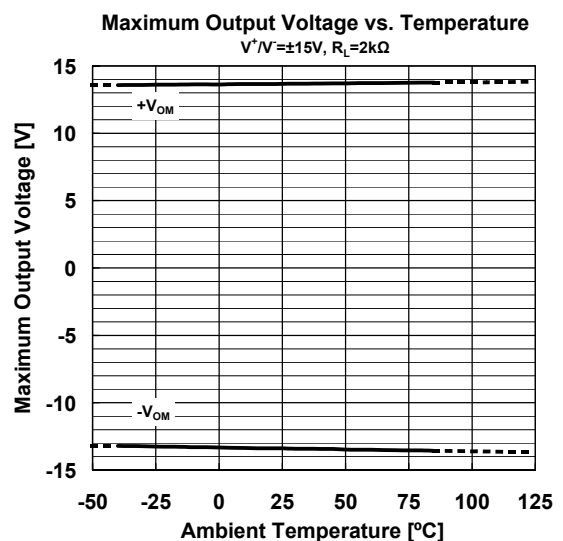
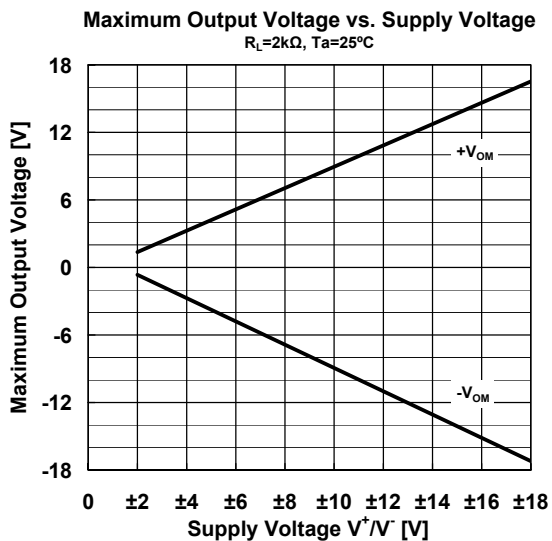
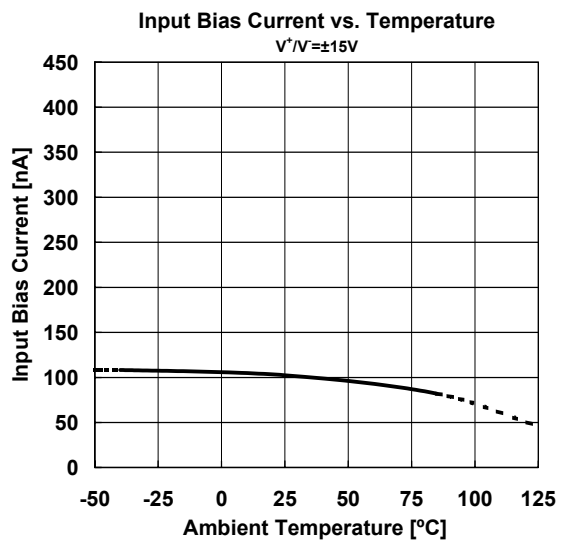
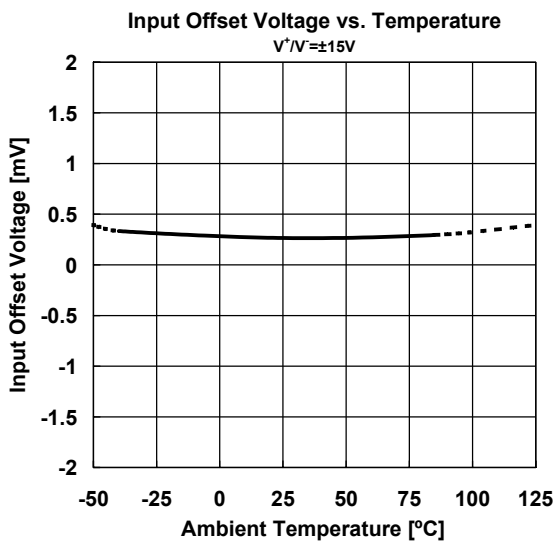
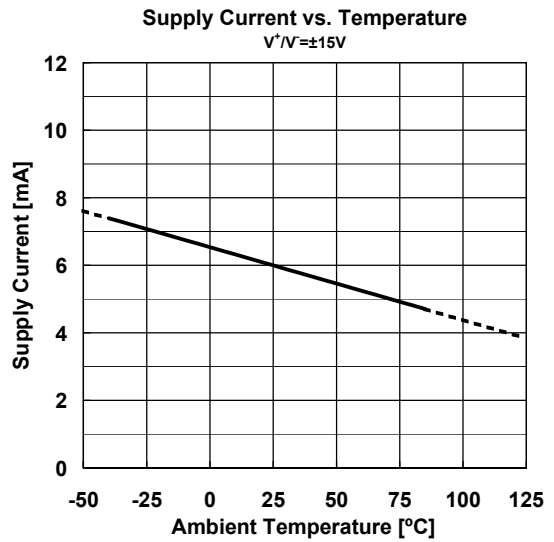
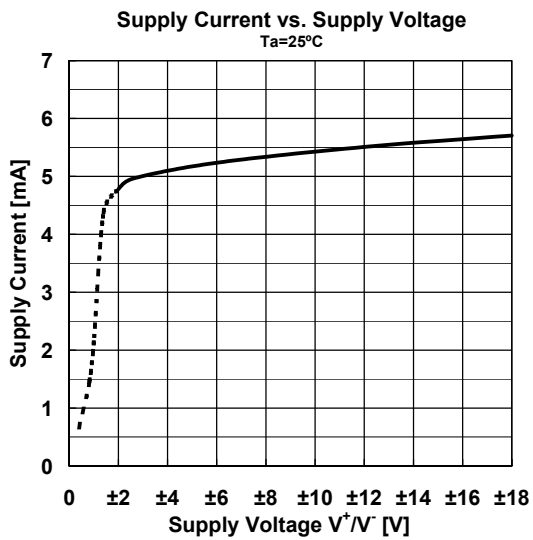

■ TEST CIRCUIT

Noise Voltage (RIAA) measurement circuit

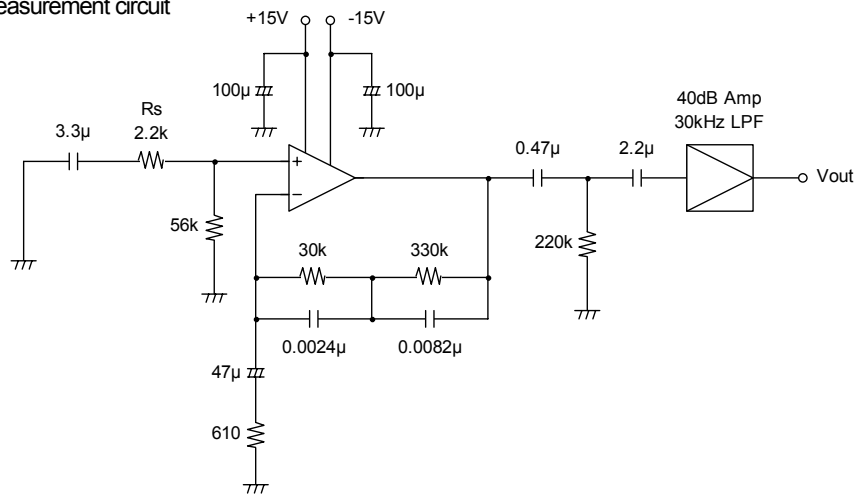

[CAUTION]

The specifications on this databook are only given for information, without any guarantee as regards either mistakes or omissions. The application circuits in this databook are described only to show representative usages of the product and not intended for the guarantee or permission of any right including the industrial rights.