

HIGH PERFORMANCE LOW-NOISE OPERATIONAL AMPLIFIER

■ GENERAL DESCRIPTION

The NJM5534 is a high performance low noise operational amplifier. This amplifier features popular pin-out, superior noise performance, and high output drive capability. And also, features guaranteed noise performance with substantially higher gain-bandwidth product, power bandwidth, and slew rate which far exceeds that of the NJM741 type amplifiers.

The specially designed low noise input transistors allow the NJM5534 to be used in very low noise signal processing applications such as audio pre-amplifiers and servo error amplifiers.

The NJM5534 is internally compensated for a gain of three or higher. Externally compensation for optimizing specific performance can be obtained by use of an external compensation capacitor between COMPENSATION(5PIN) and BALANCE/COMPENSATION(8PIN).

If very low noise characteristic is of prime importance, it is recommended D-Rank type products(NJM5534DD/MD). These have specified maximum limits for equivalent input noise voltage.

■ PACKAGE OUTLINE

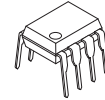

NJM5534D
(DIP8)



NJM5534M
(DMP8)

■ FEATURES

- Operating Voltage $\pm 3V \sim \pm 22V$
- Single Circuit
- With BALANCE Terminal
- Low Input Noise Voltage $3.3nV/\sqrt{Hz}$ typ.@1kHz
- Power Bandwidth 200kHz typ.
- Slew Rate $13V/\mu s$ typ.
- Package Outline DIP8, DMP8
- Bipolar Technology

■ PIN CONFIGURATION

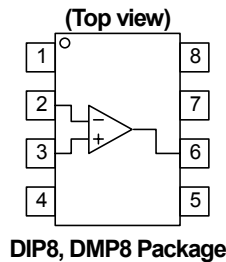

- PIN FUNCTION**
1. BALANCE
 2. -INPUT
 3. +INPUT
 4. V^-
 5. COMPENSATION
 6. OUTPUT
 7. V^+
 8. BALANCE/COMPENSATION

■ EQUIVALENT CIRCUIT

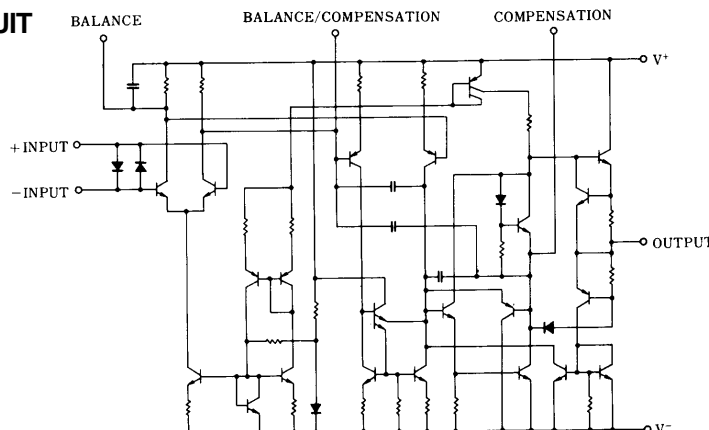

NJM5534

■ ABSOLUTE MAXIMUM RATINGS (Ta=25°C)

PARAMETER	SYMBOL	RATING	UNIT
Supply Voltage	V ⁺ /V	±22	V
Differential Input Voltage	V _{ID}	±0.5	V
Common Mode Input Voltage	V _{IC}	V ⁺ /V	V
Power Dissipation	P _D	DIP8: 500 DMP8: 300	mW
Operating Temperature Range	T _{opr}	-20~+75	°C
Storage Temperature Range	T _{stg}	-40~+125	°C

■ RECOMMENDED OPERATING VOLTAGE (Ta=25°C)

PARAMETER	SYMBOL	RATING	UNIT
Supply Voltage	V ⁺ /V	±3~±22	V

■ ELECTRICAL CHARACTERISTICS (Ta=25°C, V⁺/V=±15V, unless otherwise noted.)

PARAMETER	SYMBOL	TEST CONDITION	MIN.	TYP.	MAX.	UNIT
Input Offset Voltage	V _{IO}	R _S ≤10kΩ	-	0.5	4	mV
Input Offset Current	I _{IO}		-	20	300	nA
Input Bias Current	I _B		-	500	1500	nA
Input Resistance	R _{IN}		30	100	-	kΩ
Large Signal Voltage Gain	A _V	R _L ≥2kΩ, V _O =±10V	88	100	-	dB
Maximum Output Voltage	V _{OM}	R _L ≥600Ω	±12	±13	-	V
Common Mode Input Voltage Range	V _{ICM}		±12	±13	-	V
Common Mode Rejection Ratio	CMR	R _S ≤10kΩ	70	100	-	dB
Supply Voltage Rejection Ratio	SVR	R _S ≤10kΩ	80	100	-	dB
Supply Current	I _{CC}	R _L =∞	-	4	8	mA
Transient Response Rise Time	t _R	V _{IN} =50mV, R _L =600Ω, C _L =100pF, C _c =22pF	-	35	-	ns
Overshoot		V _{IN} =50mV, R _L =600Ω, C _L =100pF, C _c =22pF	-	17	-	%
Slew Rate	SR	C _c =0	-	13	-	V/μs
Gain Bandwidth Product	GB	C _c =22pF, C _L =100pF	-	10	-	MHz
Power Bandwidth	W _{PG}	V _O =20V _{PP} , C _c =0	-	200	-	kHz
Equivalent Input Noise Voltage	V _{NI}	f=20Hz~20kHz	-	1	-	μVrms
Equivalent Input Noise Current	I _{NI}	f=20Hz~20kHz	-	25	-	pArms
Equivalent Input Noise Voltage	e _n	f _O =30Hz	-	5.5	-	nV/√Hz
		f _O =1kHz	-	3.3	-	nV/√Hz
Equivalent Input Noise Current	i _n	f _O =30Hz	-	1.5	-	pA/√Hz
		f _O =1kHz	-	0.4	-	pA/√Hz
Broadband Noise Figure	NF	f=10Hz~20kHz, R _S =5kΩ	-	0.9	-	dB

■ ELECTRICAL CHARACTERISTICS (D-rank type(Note1), V⁺/V=±15V, Ta=25°C, unless otherwise noted.)

PARAMETER	SYMBOL	TEST CONDITION	MIN.	TYP.	MAX.	UNIT
Equivalent Input Noise Voltage	V _{NI}	RIAA, R _S =2.2kΩ	-	-	1.4	μVrms

(Note1) D-rank type is a Equivalent Input Noise Voltage selected product.

■ TYPICAL CHARACTERISTICS

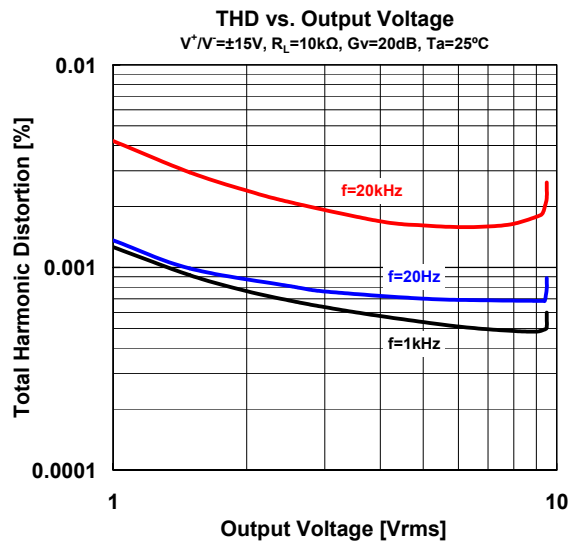
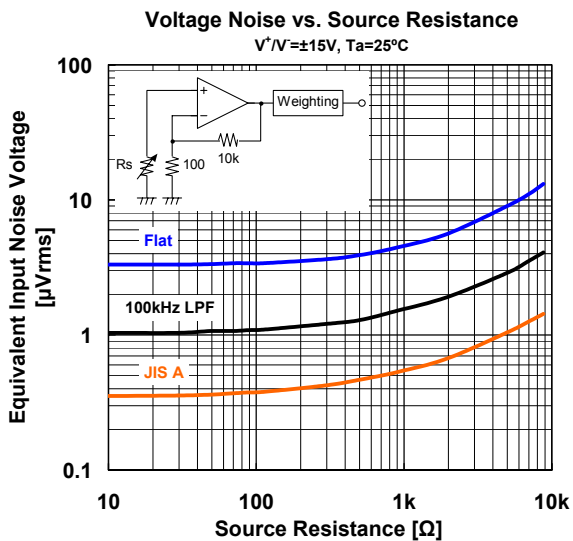
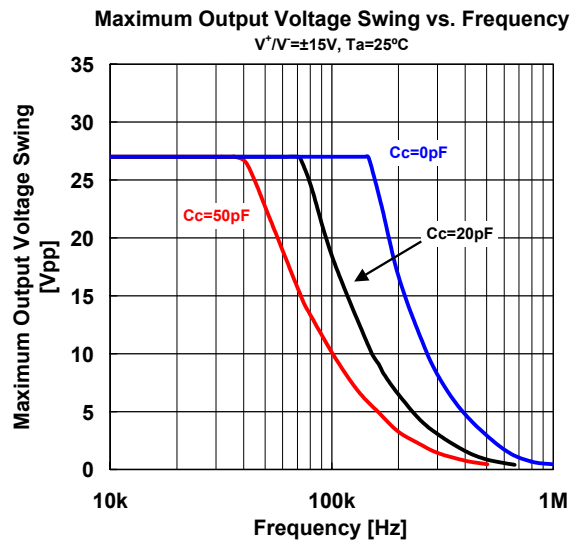
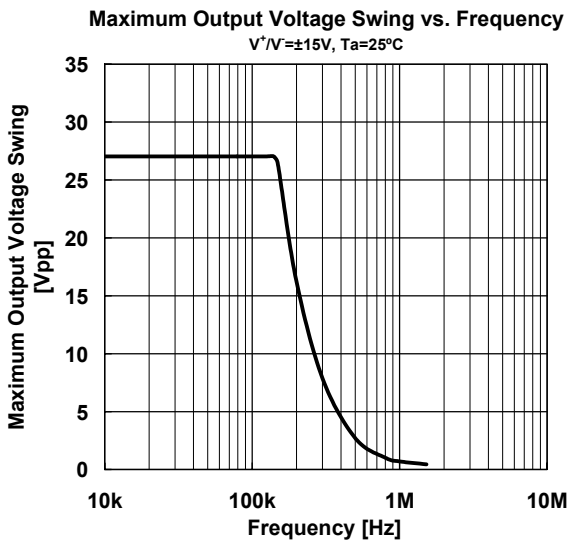
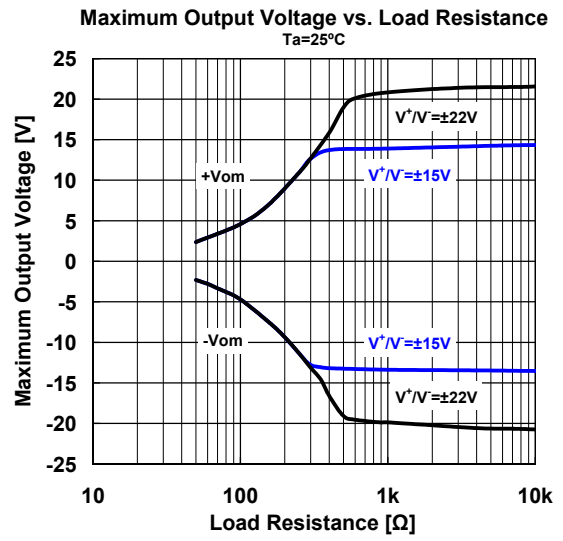
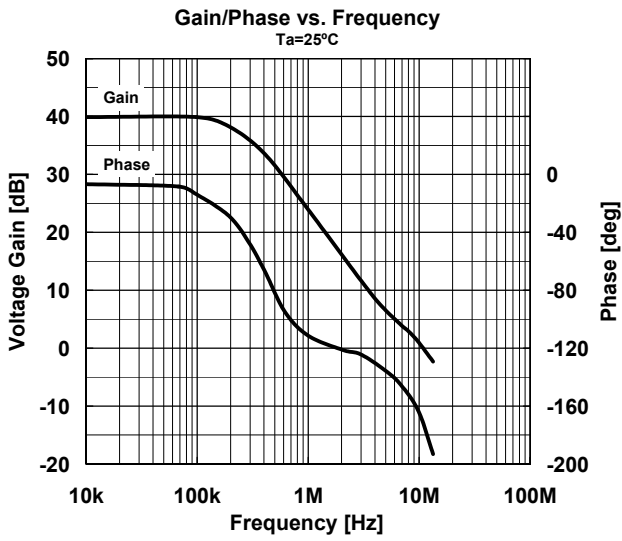

■ TYPICAL CHARACTERISTICS

Supply Current vs. Temperature
 $V^+/V^-=\pm 15V$

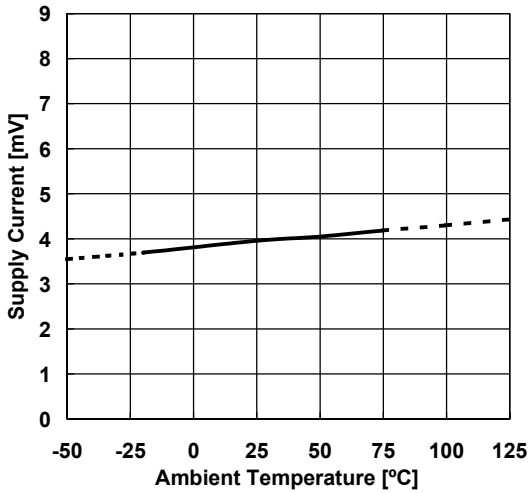

Input Offset Voltage vs. Temperature
 $V^+/V^-=\pm 15V$

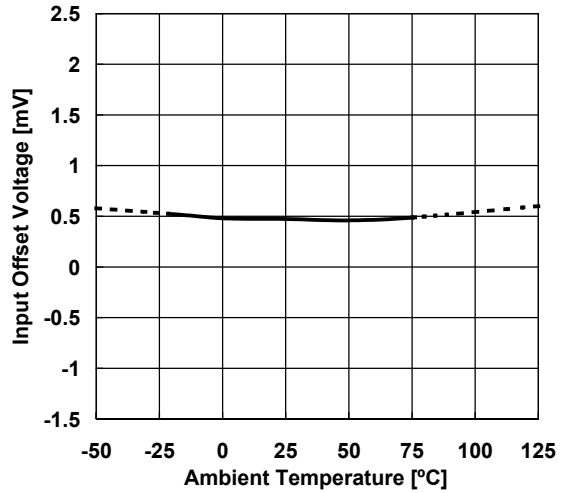

Input Bias Current vs. Temperature
 $V^+/V^-=\pm 15V$

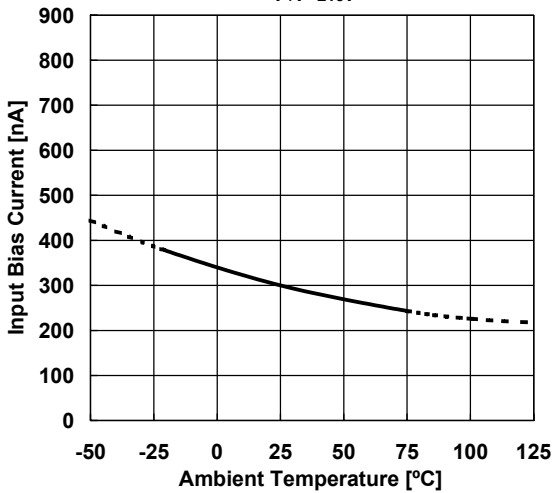

Maximum Output Voltage vs. Temperature
 $V^+/V^-=\pm 15V, R_L=600\Omega$

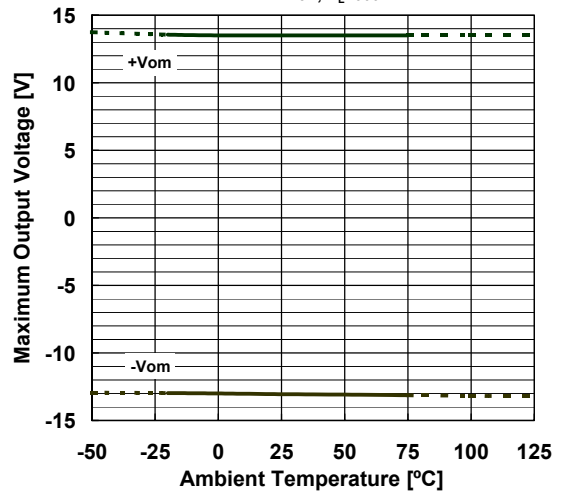

Slew Rate vs. Compensation Capacitance
 $T_a=25^\circ C$

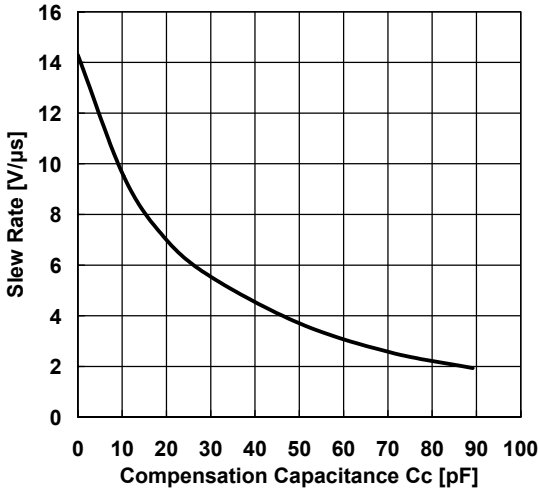

■ TEST CIRCUIT

Noise Voltage (RIAA) measurement circuit

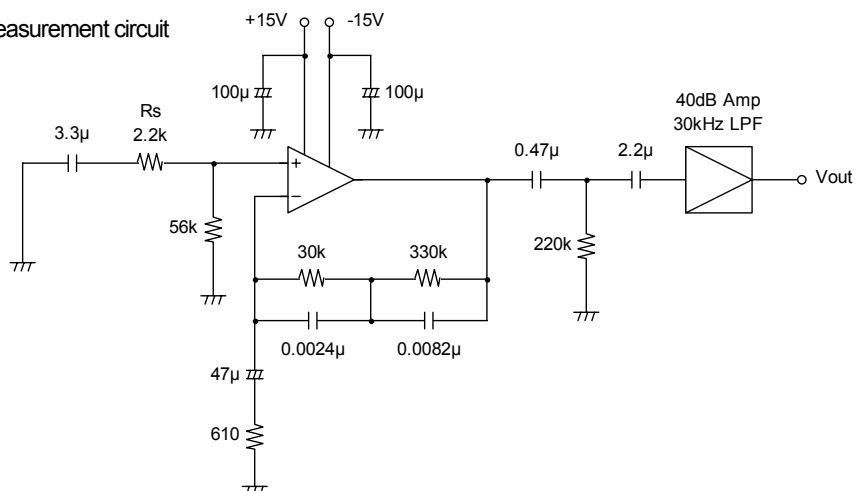

■ ADJUSTMENT METHOD

Fig.1-1, Fig.1-2 shows the input offset voltage adjustment circuit, and frequency compensation circuit. Without these features, the adjustment pins are open.

Fig.1-1 Input Offset Voltage Adjustment

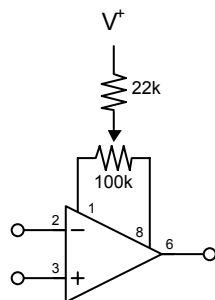
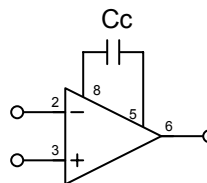

Fig.1-2 Frequency Compensation



■ NOTICE

When used in voltage follower circuit, put a current limit resistor into non-inverting input terminal in order to avoid inside input diode destruction when the power supply is turned on. (ref.Fig.2)

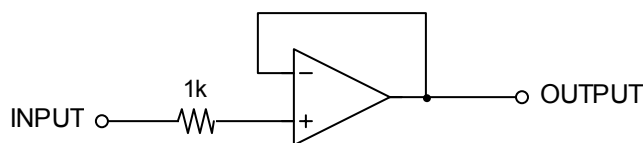

Fig.2

[CAUTION]

The specifications on this databook are only given for information, without any guarantee as regards either mistakes or omissions. The application circuits in this databook are described only to show representative usages of the product and not intended for the guarantee or permission of any right including the industrial rights.