

SINGLE GENERAL PURPOSE OPERATIONAL AMPLIFIER

■ GENERAL DESCRIPTION

The NJM741 is a high performance Monolithic Operational Amplifier constructed using the New JRC Planar epitaxial process. It is intended for a wide range of analog applications. High common mode voltage range and absence of latch-up tendencies make the NJM741 ideal for use as a voltage follower. The high gain and wide range of operating voltage provides superior performance in integrator, summing amplifier, and general feedback applications.

■ PACKAGE OUTLINE

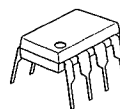

NJM741D



NJM741M



NJM741V

■ FEATURES

- Operating Voltage (+3V ~ +18V)
- Single Supply
- With  $V_{IO}$  Trim Terminal
- Package Outline DIP8, DMP8, (SSOP8)
- Bipolar Technology

■ PIN CONFIGURATION

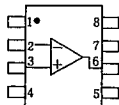

NJM741D  
NJM741M  
NJM741V

PIN FUNCTION

1.  $V_{OS}$  Trim
2. - Input
3. + Input
4.  $V^-$
5.  $V_{OS}$  Trim
6. Output
7.  $V^+$
8. NC

■ EQUIVALENT CIRCUIT

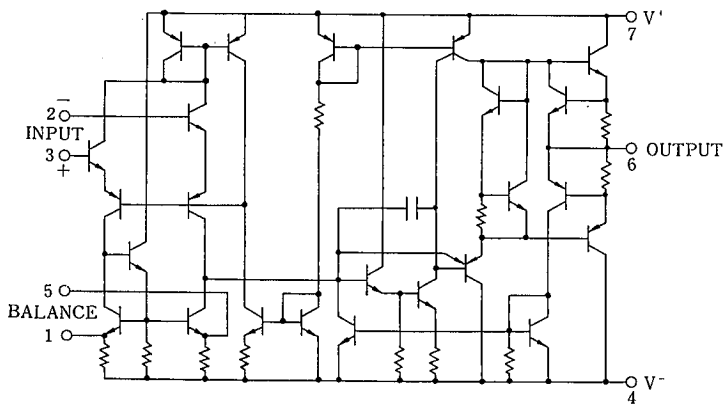

## ■ ABSOLUTE MAXIMUM RATINGS

(Ta=25°C)

PARAMETER	SYMBOL	RATINGS	UNIT
Supply Voltage	V <sup>+</sup> /V <sup>-</sup>	±18	V
Input Voltage	V <sub>IC</sub>	±15 (note)	V
Differential Input Voltage	V <sub>ID</sub>	±30	V
Power Dissipation	P <sub>D</sub>	(DIP8) 500	mW
		(DMP8) 300	mW
		(SSOP8) 300	mW
Operating Temperature Range	T <sub>opr</sub>	-40 ~ +85	°C
Storage Temperature Range	T <sub>stg</sub>	-40 ~ +125	°C

(note) For supply voltage less than ±15V, the absolute maximum input voltage is equal to the supply voltage.

## ■ ELECTRICAL CHARACTERISTICS

(Ta=25°C, V<sup>+</sup>/V<sup>-</sup>=±15V)

PARAMETER	SYMBOL	TEST CONDITION	MIN.	TYP.	MAX.	UNIT
Input Offset Voltage	V <sub>IO</sub>	R <sub>S</sub> ≤ 10kΩ	—	2.0	6.0	mV
Input Offset Current	I <sub>IO</sub>		—	5	200	nA
Input Bias Current	I <sub>IB</sub>		—	30	500	nA
Input Resistance	R <sub>IN</sub>		0.3	2.0	—	MΩ
Large-signal Voltage Gain	A <sub>V</sub>	R <sub>L</sub> ≥ 2kΩ, V <sub>O</sub> = ±10V	86	110	—	dB
Maximum Output Voltage Swing 1	V <sub>OM1</sub>	R <sub>L</sub> ≥ 10kΩ	±12	±14	—	V
Maximum Output Voltage Swing 2	V <sub>OM2</sub>	R <sub>L</sub> ≥ 2kΩ	±10	±13	—	V
Input Common Mode Voltage Range	V <sub>ICM</sub>		±12	±13	—	V
Common Mode Rejection Ratio	CMR	R <sub>S</sub> ≤ 10kΩ	70	100	—	dB
Supply Voltage Rejection Ratio	SVR	R <sub>S</sub> ≤ 10kΩ	76.5	100	—	dB <sup>-1</sup>
Operating Current	I <sub>CC</sub>		—	1.7	2.8	mA
Slew Rate	SR	R <sub>L</sub> ≥ 2kΩ	—	0.5	—	V/μs
Transient Response (Unity Gain) (Rise Time)	t <sub>r</sub>	V <sub>IN</sub> = 20mV, R <sub>L</sub> = 2kΩ, C <sub>L</sub> = 100pF	—	0.3	—	μs
Transient Response (Unity Gain) (Overshoot)	t <sub>o</sub>	V <sub>IN</sub> = 20mV, R <sub>L</sub> = 2kΩ, C <sub>L</sub> = 100pF	—	5.0	—	%

■ TYPICAL CHARACTERISTICS

Maximum Output Voltage Swing vs. Frequency

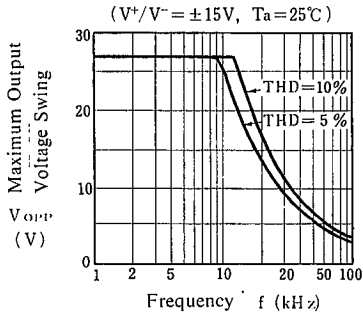

Maximum Output Voltage Swing vs. Load Resistance

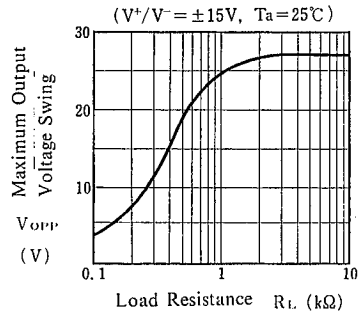

Input Bias Current vs. Temperature

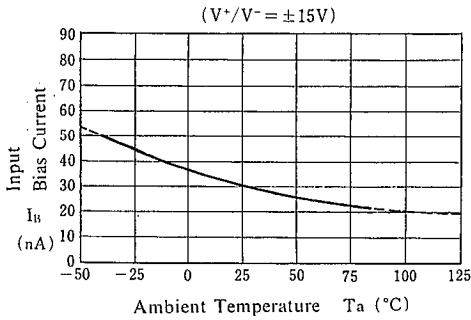

Maximum Output Voltage Swing vs. Operating Voltage

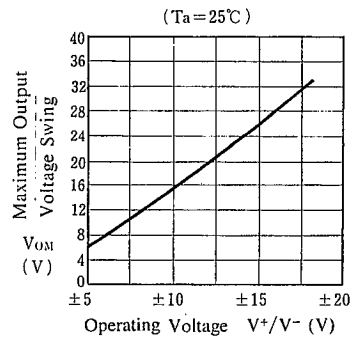

Voltage-follower Large-signal Pulse Response

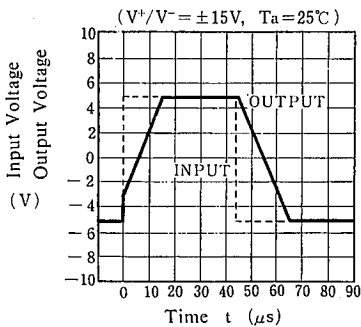

Voltage Gain, Phase vs. Frequency

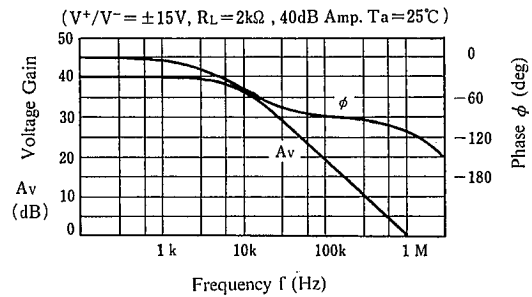

## TYPICAL CHARACTERISTICS

Operating Current vs. Temperature

( $V^+/V^- = \pm 15V$ )

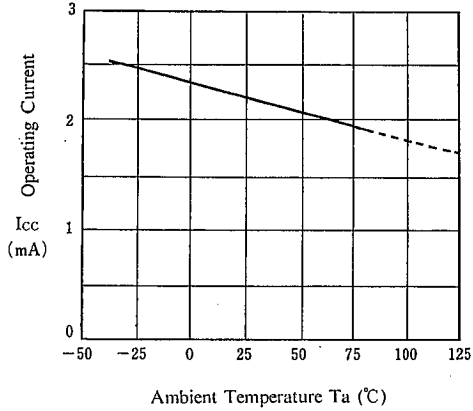

Input Offset Voltage vs. Temperature

( $V^+/V^- = \pm 15V$ )

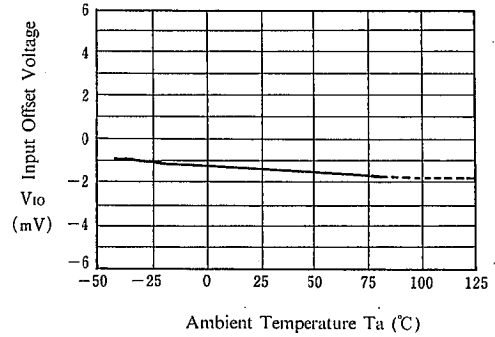

Maximum Output Voltage vs. Temperature

( $V^+/V^- = \pm 15V, R_L = 10k\Omega$ )

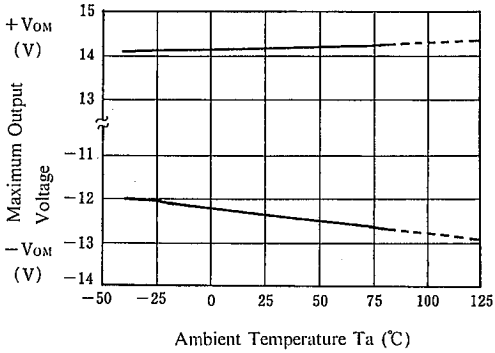

## OFFSET ADJUSTMENT CIRCUIT

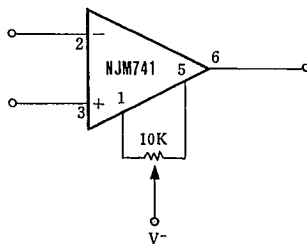

## MEMO

[CAUTION]

The specifications on this databook are only given for information, without any guarantee as regards either mistakes or omissions. The application circuits in this databook are described only to show representative usages of the product and not intended for the guarantee or permission of any right including the industrial rights.