

3-TERMINAL POSITIVE VOLTAGE REGULATOR

■ GENERAL DESCRIPTION

The NJM78L00S is a 100mA output 3-Terminal Positive Voltage regulator.

It has improvements in contrast with a conventional NJM78L00: an output voltage accuracy, an operating temperature range and MLCC correspondence. Moreover, the NJM78L00s has 3.3V output voltage version.

■ PACKAGE OUTLINE

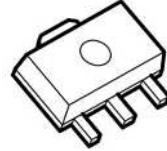

NJM78L00SU3
(SOT-89-3)

■ FEATURE

- Output Current 100 mA max.
- High Precision Output Voltage $V_O \pm 4.0\%$
- High Ripple Rejection
- Correspond to Low ESR Capacitor (MLCC)
- Over Current Protection Circuit
- Thermal Shutdown Circuit
- Output Voltage Lineup 3V, 3.3V, 5V, 6V, 8V, 10V, 12V, 15V
- Bipolar Technology
- Package SOT-89-3

■ PIN CONFIGURATION

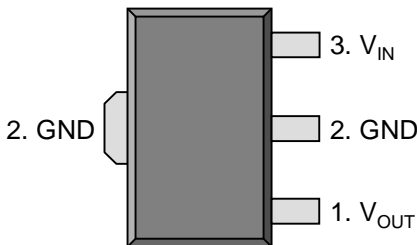

■ EQUIVALENT CIRCUIT

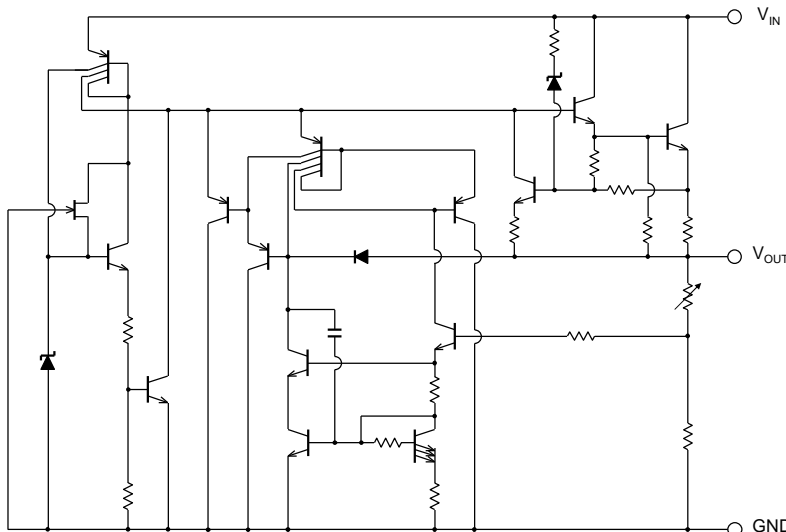

NJM78L00S

■ ABSOLUTE MAXIMUM RATINGS

(Unless otherwise noted, $T_a = 25^\circ\text{C}$)

PARAMETER	SYMBOL	MAXIMUM RATINGS	UNIT
Input Voltage	V_{IN}	NJM78L03S to NJM78L08S : 30 NJM78L10S to NJM78L15S : 35	V
Power Dissipation	P_D	625 (*1) 2400 (*2)	mW
Junction Temperature Range	T_j	- 40 to + 150	$^\circ\text{C}$
Operating Temperature Range	T_{opr}	- 40 to + 125	$^\circ\text{C}$
Storage Temperature Range	T_{stg}	- 50 to + 150	$^\circ\text{C}$

(*1) Mounted on glass epoxy board. (76.2×114.3×1.6mm:EIA/JDEC standard size, 2Layers, copper area 100mm²)

(*2) Mounted on glass epoxy board. (76.2×114.3×1.6mm:EIA/JDEC standard size, 4Layers)

(4Layers inner foil: 74.2 ×74.2mm applying a thermal via hole to a board based on JEDEC standard JESD51-5)

■ ELECTRICAL CHARACTERISTICS

($C_{IN}=0.33\mu\text{F}$, $C_O=0.1\mu\text{F}$, $T_j=25^\circ\text{C}$) Measurement is to be conducted is pulse testing.

PARAMETER	SYMBOL	TEST CONDITION	MIN.	TYP.	MAX.	UNIT
NJM78L03SU3						
Output Voltage	V_O	$V_{IN}=9\text{V}$, $I_O=40\text{mA}$	2.88	3.0	3.12	V
Line Regulation 1	ΔV_O-V_{IN1}	$V_{IN}=5\text{V}$ to 20V, $I_O=40\text{mA}$	-	-	125	mV
Line Regulation 2	ΔV_O-V_{IN2}	$V_{IN}=6\text{V}$ to 20V, $I_O=40\text{mA}$	-	-	100	mV
Load Regulation 1	ΔV_O-I_{O1}	$V_{IN}=9\text{V}$, $I_O=1$ to 40 mA	-	-	25	mV
Load Regulation 2	ΔV_O-I_{O2}	$V_{IN}=9\text{V}$, $I_O=1$ to 100 mA	-	-	50	mV
Quiescent Current	I_Q	$V_{IN}=9\text{V}$, $I_O=0\text{mA}$	-	2.0	6	mA
Average Temperature Coefficient of Output Voltage	$\Delta V_O/\Delta T$	$V_{IN}=9\text{V}$, $I_O=1\text{mA}$	-	0.2	-	mV/ $^\circ\text{C}$
Ripple Rejection	RR	$6\text{V}<V_{IN}<16\text{V}$, $I_O=40\text{mA}$, $e_{in}=1V_{P-P}$, $f=120\text{Hz}$	43	72	-	dB
Output Noise Voltage	V_{NO}	$V_{IN}=9\text{V}$, $BW=10\text{Hz}$ to 100kHz, $I_O=40\text{mA}$	-	40	-	μVrms
Dropout Voltage	ΔV_{IO}	$I_O=100\text{mA}$	-	1.7	-	V

NJM78L33SU3

Output Voltage	V_O	$V_{IN}=9.3\text{V}$, $I_O=40\text{mA}$	3.17	3.3	3.43	V
Line Regulation 1	ΔV_O-V_{IN1}	$V_{IN}=5.3\text{V}$ to 20V, $I_O=40\text{mA}$	-	-	135	mV
Line Regulation 2	ΔV_O-V_{IN2}	$V_{IN}=6.3\text{V}$ to 20V, $I_O=40\text{mA}$	-	-	105	mV
Load Regulation 1	ΔV_O-I_{O1}	$V_{IN}=9.3\text{V}$, $I_O=1$ to 40mA	-	-	26	mV
Load Regulation 2	ΔV_O-I_{O2}	$V_{IN}=9.3\text{V}$, $I_O=1$ to 100mA	-	-	53	mV
Quiescent Current	I_Q	$V_{IN}=9.3\text{V}$, $I_O=0\text{mA}$	-	2.0	6	mA
Average Temperature Coefficient of Output Voltage	$\Delta V_O/\Delta T$	$V_{IN}=9.3\text{V}$, $I_O=1\text{mA}$	-	0.25	-	mV/ $^\circ\text{C}$
Ripple Rejection	RR	$6.3\text{V}<V_{IN}<16.3\text{V}$, $I_O=40\text{mA}$, $e_{in}=1V_{P-P}$, $f=120\text{Hz}$	42	71	-	dB
Output Noise Voltage	V_{NO}	$V_{IN}=9.3\text{V}$, $BW=10\text{Hz}$ to 100kHz, $I_O=40\text{mA}$	-	45	-	μVrms
Dropout Voltage	ΔV_{IO}	$I_O=100\text{mA}$	-	1.7	-	V

■ ELECTRICAL CHARACTERISTICS

($C_{IN}=0.33\mu F$, $C_O=0.1\mu F$, $T_f=25^\circ C$) Measurement is to be conducted is pulse testing.

PARAMETER	SYMBOL	TEST CONDITION	MIN.	TYP.	MAX.	UNIT
NJM78L05SU3						
Output Voltage	V_O	$V_{IN}=10V$, $I_O=40mA$	4.8	5.0	5.2	V
Line Regulation 1	ΔV_O-V_{IN1}	$V_{IN}=7V$ to $20V$, $I_O=40mA$	-	-	200	mV
Line Regulation 2	ΔV_O-V_{IN2}	$V_{IN}=8V$ to $20V$, $I_O=40mA$	-	-	150	mV
Load Regulation 1	ΔV_O-I_{O1}	$V_{IN}=10V$, $I_O=1$ to $40mA$	-	-	30	mV
Load Regulation 2	ΔV_O-I_{O2}	$V_{IN}=10V$, $I_O=1$ to $100mA$	-	-	60	mV
Quiescent Current	I_Q	$V_{IN}=10V$, $I_O=0mA$	-	2.0	6	mA
Average Temperature Coefficient of Output Voltage	$\Delta V_O/\Delta T$	$V_{IN}=10V$, $I_O=1mA$	-	0.4	-	mV/°C
Ripple Rejection	RR	$8V < V_{IN} < 18V$, $I_O=40mA$, $e_{in}=1V_{P-P}$, $f=120Hz$	40	69	-	dB
Output Noise Voltage	V_{NO}	$V_{IN}=10V$, $BW=10Hz$ to $100kHz$, $I_O=40mA$	-	70	-	μV_{rms}
Dropout Voltage	ΔV_{IO}	$I_O=100mA$	-	1.7	-	V

NJM78L06SU3						
Output Voltage	V_O	$V_{IN}=12V$, $I_O=40mA$	5.76	6.0	6.24	V
Line Regulation 1	ΔV_O-V_{IN1}	$V_{IN}=8.5V$ to $20V$, $I_O=40mA$	-	-	200	mV
Line Regulation 2	ΔV_O-V_{IN2}	$V_{IN}=9V$ to $20V$, $I_O=40mA$	-	-	150	mV
Load Regulation 1	ΔV_O-I_{O1}	$V_{IN}=12V$, $I_O=1$ to $40mA$	-	-	40	mV
Load Regulation 2	ΔV_O-I_{O2}	$V_{IN}=12V$, $I_O=1$ to $100mA$	-	-	80	mV
Quiescent Current	I_Q	$V_{IN}=12V$, $I_O=0mA$	-	2.0	6	mA
Average Temperature Coefficient of Output Voltage	$\Delta V_O/\Delta T$	$V_{IN}=12V$, $I_O=1mA$	-	0.5	-	mV/°C
Ripple Rejection	RR	$9V < V_{IN} < 20V$, $I_O=40mA$, $e_{in}=1V_{P-P}$, $f=120Hz$	40	67	-	dB
Output Noise Voltage	V_{NO}	$V_{IN}=12V$, $BW=10Hz$ to $100kHz$, $I_O=40mA$	-	80	-	μV_{rms}
Dropout Voltage	ΔV_{IO}	$I_O=100mA$	-	1.7	-	V

NJM78L08SU3						
Output Voltage	V_O	$V_{IN}=14V$, $I_O=40mA$	7.68	8.0	8.32	V
Line Regulation 1	ΔV_O-V_{IN1}	$V_{IN}=10.5V$ to $23V$, $I_O=40mA$	-	-	225	mV
Line Regulation 2	ΔV_O-V_{IN2}	$V_{IN}=11V$ to $23V$, $I_O=40mA$	-	-	175	mV
Load Regulation 1	ΔV_O-I_{O1}	$V_{IN}=14V$, $I_O=1$ to $40mA$	-	-	50	mV
Load Regulation 2	ΔV_O-I_{O2}	$V_{IN}=14V$, $I_O=1$ to $100mA$	-	-	100	mV
Quiescent Current	I_Q	$V_{IN}=14V$, $I_O=0mA$	-	2.1	6	mA
Average Temperature Coefficient of Output Voltage	$\Delta V_O/\Delta T$	$V_{IN}=14V$, $I_O=1mA$	-	0.6	-	mV/°C
Ripple Rejection	RR	$11V < V_{IN} < 20V$, $I_O=40mA$, $e_{in}=1V_{P-P}$, $f=120Hz$	39	66	-	dB
Output Noise Voltage	V_{NO}	$V_{IN}=14V$, $BW=10Hz$ to $100kHz$, $I_O=40mA$	-	115	-	μV_{rms}
Dropout Voltage	ΔV_{IO}	$I_O=100mA$	-	1.7	-	V

NJM78L00S

■ ELECTRICAL CHARACTERISTICS

($C_{IN}=0.33\mu F$, $C_O=0.1\mu F$, $T_J=25^\circ C$) Measurement is to be conducted is pulse testing.

PARAMETER	SYMBOL	TEST CONDITION	MIN.	TYP.	MAX.	UNIT
NJM78L10SU3						
Output Voltage	V_O	$V_{IN}=16V, I_O=40mA$	9.6	10.0	10.4	V
Line Regulation 1	ΔV_O-V_{IN1}	$V_{IN}=13V \text{ to } 25V, I_O=40mA$	-	-	250	mV
Line Regulation 2	ΔV_O-V_{IN2}	$V_{IN}=14V \text{ to } 25V, I_O=40mA$	-	-	200	mV
Load Regulation 1	ΔV_O-I_{O1}	$V_{IN}=16V, I_O=1 \text{ to } 40mA$	-	-	50	mV
Load Regulation 2	ΔV_O-I_{O2}	$V_{IN}=16V, I_O=1 \text{ to } 100mA$	-	-	100	mV
Quiescent Current	I_Q	$V_{IN}=16V, I_O=0mA$	-	2.1	6	mA
Average Temperature Coefficient of Output Voltage	$\Delta V_O/\Delta T$	$V_{IN}=16V, I_O=1mA$	-	0.7	-	mV/°C
Ripple Rejection	RR	$13V < V_{IN} < 22V, I_O=40mA,$ $e_{in}=1V_{P-P}, f=120Hz$	37	64	-	dB
Output Noise Voltage	V_{NO}	$V_{IN}=16V, BW=10Hz \text{ to } 100kHz, I_O=40mA$	-	135	-	μV_{rms}
Dropout Voltage	ΔV_{IO}	$I_O=100mA$	-	1.7	-	V

NJM78L12SU3						
Output Voltage	V_O	$V_{IN}=19V, I_O=40mA$	11.52	12.0	12.48	V
Line Regulation 1	ΔV_O-V_{IN1}	$V_{IN}=14.5V \text{ to } 27V, I_O=40mA$	-	-	250	mV
Line Regulation 2	ΔV_O-V_{IN2}	$V_{IN}=16V \text{ to } 27V, I_O=40mA$	-	-	200	mV
Load Regulation 1	ΔV_O-I_{O1}	$V_{IN}=19V, I_O=1 \text{ to } 40mA$	-	-	50	mV
Load Regulation 2	ΔV_O-I_{O2}	$V_{IN}=19V, I_O=1 \text{ to } 100mA$	-	-	100	mV
Quiescent Current	I_Q	$V_{IN}=19V, I_O=0mA$	-	2.1	6.5	mA
Average Temperature Coefficient of Output Voltage	$\Delta V_O/\Delta T$	$V_{IN}=19V, I_O=1mA$	-	0.9	-	mV/°C
Ripple Rejection	RR	$15V < V_{IN} < 25V, I_O=40mA,$ $e_{in}=1V_{P-P}, f=120Hz$	37	62	-	dB
Output Noise Voltage	V_{NO}	$V_{IN}=19V, BW=10Hz \text{ to } 100kHz, I_O=40mA$	-	160	-	μV_{rms}
Dropout Voltage	ΔV_{IO}	$I_O=100mA$	-	1.7	-	V

NJM78L15SU3						
Output Voltage	V_O	$V_{IN}=23V, I_O=40mA$	14.4	15.0	15.6	V
Line Regulation 1	ΔV_O-V_{IN1}	$V_{IN}=17.5V \text{ to } 30V, I_O=40mA$	-	-	300	mV
Line Regulation 2	ΔV_O-V_{IN2}	$V_{IN}=20V \text{ to } 30V, I_O=40mA$	-	-	250	mV
Load Regulation 1	ΔV_O-I_{O1}	$V_{IN}=23V, I_O=1 \text{ to } 40mA$	-	-	75	mV
Load Regulation 2	ΔV_O-I_{O2}	$V_{IN}=23V, I_O=1 \text{ to } 100mA$	-	-	150	mV
Quiescent Current	I_Q	$V_{IN}=23V, I_O=0mA$	-	2.2	6.5	mA
Average Temperature Coefficient of Output Voltage	$\Delta V_O/\Delta T$	$V_{IN}=23V, I_O=1mA$	-	1.0	-	mV/°C
Ripple Rejection	RR	$18.5V < V_{IN} < 28.5V, I_O=40mA,$ $e_{in}=1V_{P-P}, f=120Hz$	34	60	-	dB
Output Noise Voltage	V_{NO}	$V_{IN}=23V, BW=10Hz \text{ to } 100kHz, I_O=40mA$	-	190	-	μV_{rms}
Dropout Voltage	ΔV_{IO}	$I_O=100mA$	-	1.7	-	V

■ TEST CIRCUIT

1. Output Voltage, Line Regulation, Load Regulation, Quiescent Current, Average, Output Noise Voltage, Temperature Coefficient of Output Voltage, Peak Output/Short Circuit Current

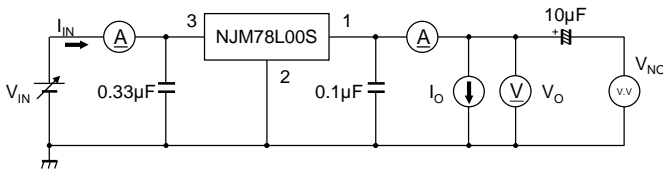

- Measurement is to be conducted in pulse testing

- $I_Q = I_{IN} - I_O$

2. Ripple Rejection

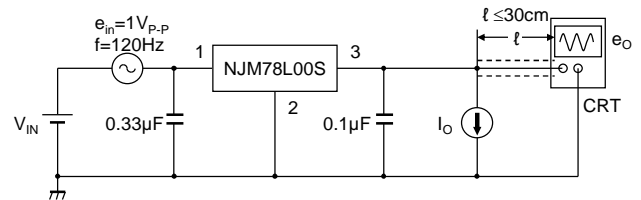

$$RR = 20 \log_{10} \left(\frac{e_{in}}{e_o} \right)$$

- Input Capacitor C_{IN}

Input Capacitor C_{IN} is required to prevent oscillation and reduce power supply ripple for applications when high power supply impedance or a long power supply line.

Therefore, use the recommended C_{IN} value (refer to conditions of ELECTRIC CHARACTERISTIC) or larger and should connect between GND and V_{IN} as shortest path as possible to avoid the problem.

- Output Capacitor C_O

Output capacitor (C_O) will be required for a phase compensation of the internal error amplifier.

The capacitance and the equivalent series resistance (ESR) influence to stable operation of the regulator.

Use of a smaller C_O may cause excess output noise or oscillation of the regulator due to lack of the phase compensation.

On the other hand, Use of a larger C_O reduces output noise and ripple output, and also improves output transient response when rapid load change.

Therefore, use the recommended C_O value (refer to conditions of ELECTRIC CHARACTERISTIC) or larger and should connect between GND and V_{OUT} as shortest path as possible for stable operation.

In addition, you should consider varied characteristics of capacitor (a frequency characteristic, a temperature characteristic, a DC bias characteristic and so on) and unevenness peculiar to a capacitor supplier enough.

When selecting C_O , recommend that have withstand voltage margin against output voltage and superior temperature characteristic though this product is designed stability works with wide range ESR of capacitor including low ESR products.

NJM78L00S

■ POWER DISSIPATION vs. AMBIENT TEMPERATURE

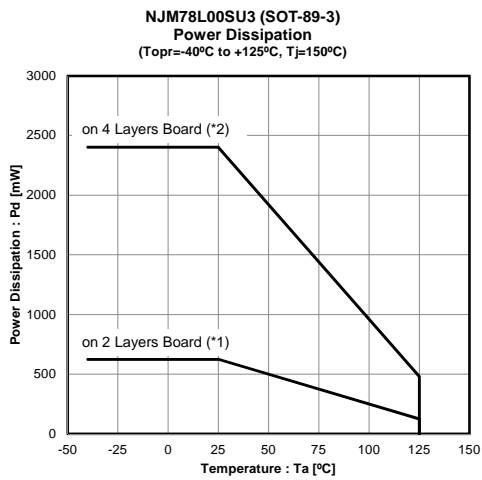

(*1) Mounted on glass epoxy board. (76.2×114.3×1.6mm:EIA/JDEC standard size, 2Layers, copper area 100mm²)

(*2) Mounted on glass epoxy board. (76.2×114.3×1.6mm:EIA/JDEC standard size, 4Layers)

(4Layers inner foil: 74.2 ×74.2mm applying a thermal via hole to a board based on JEDEC standard JESD51-5)

■ TYPICAL CHARACTERISTICS (3V)

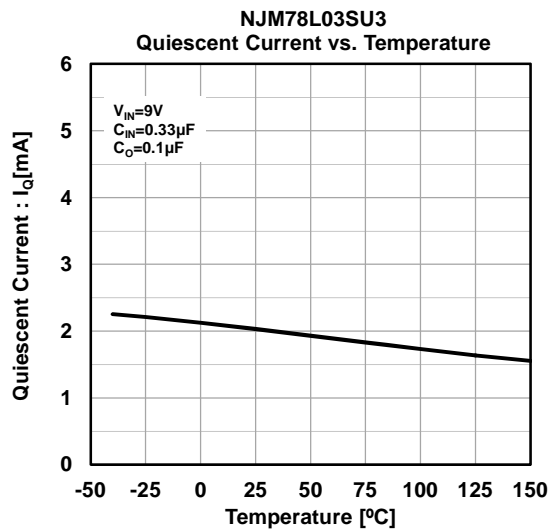
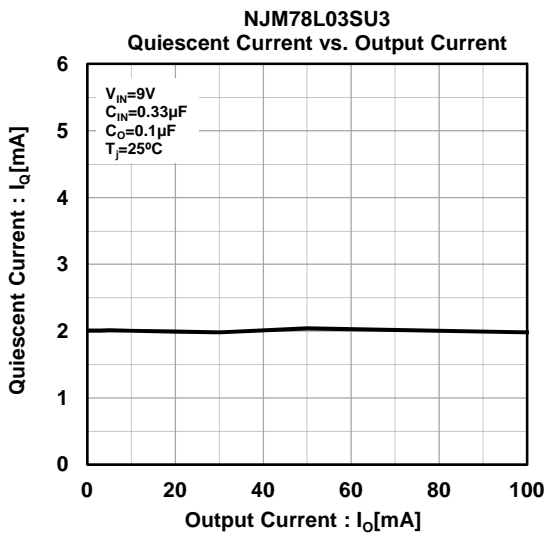
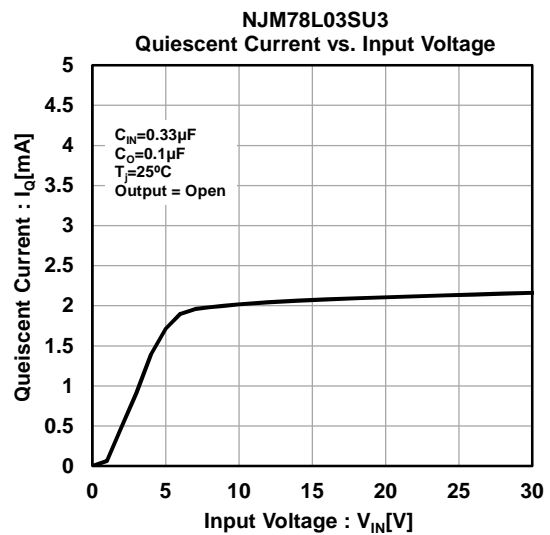
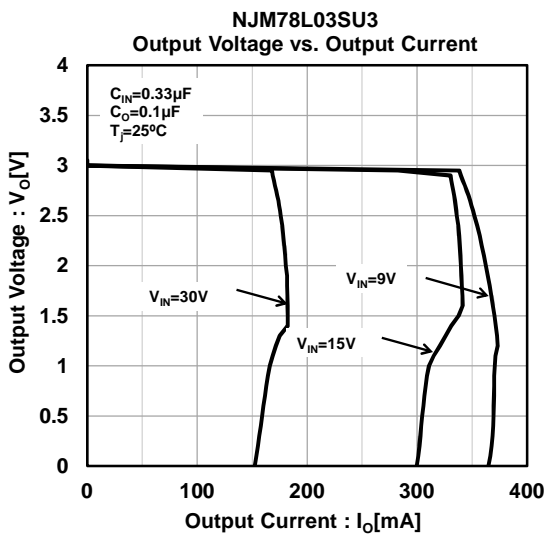
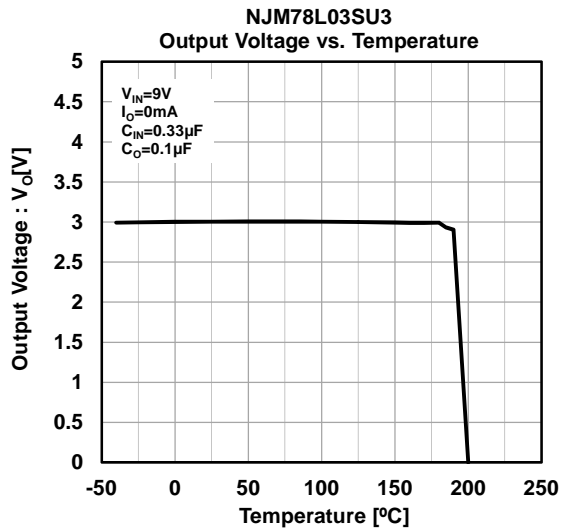
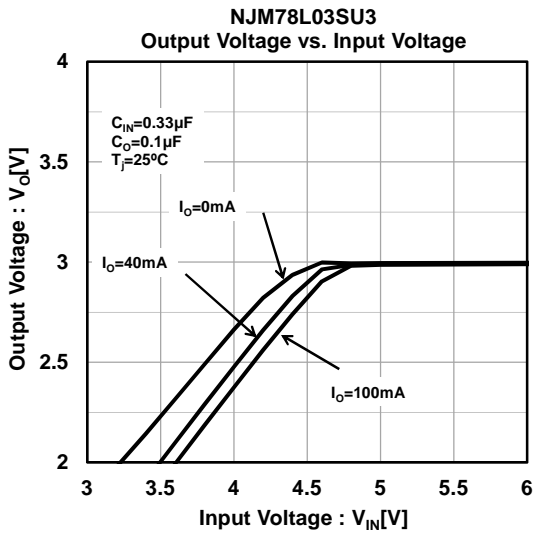

NJM78L00S

■ TYPICAL CHARACTERISTICS (3V)

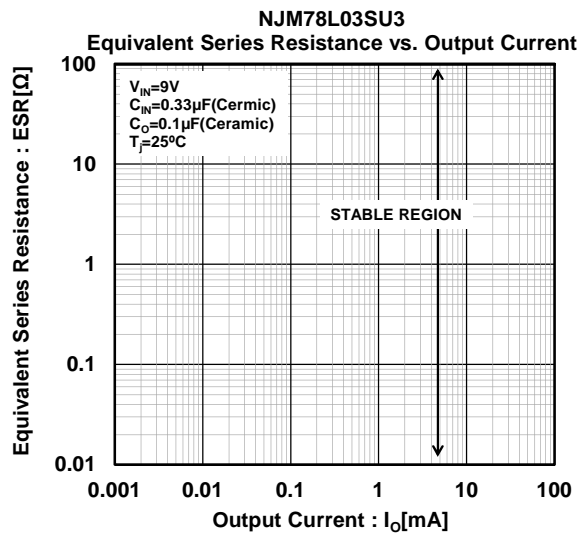
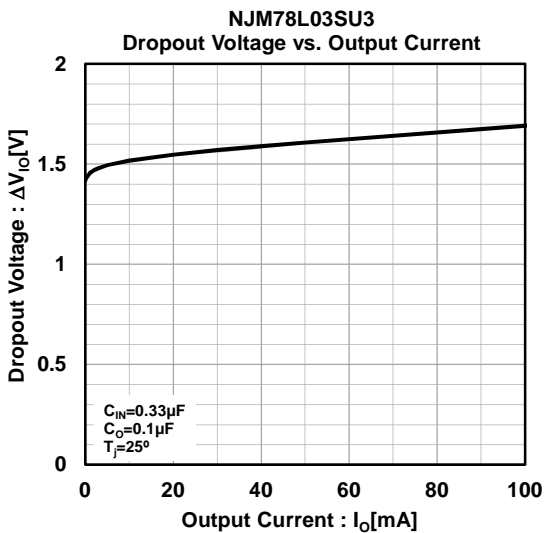
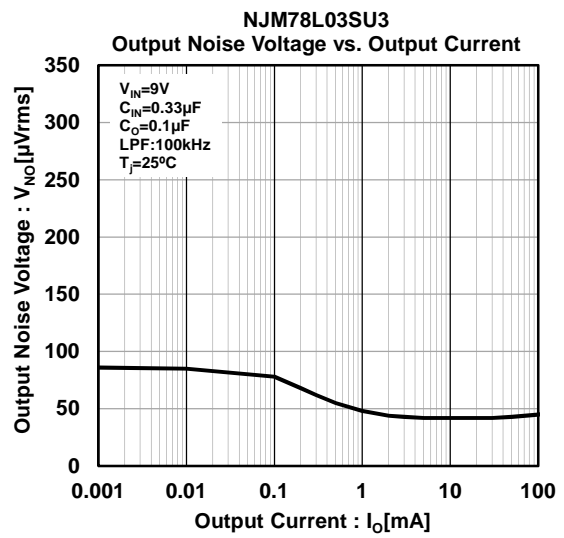
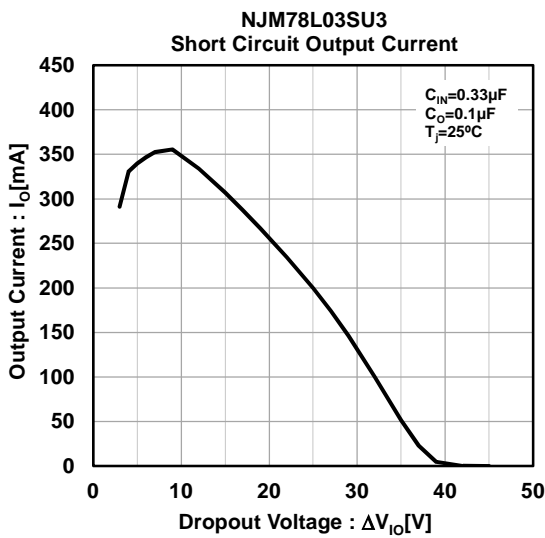
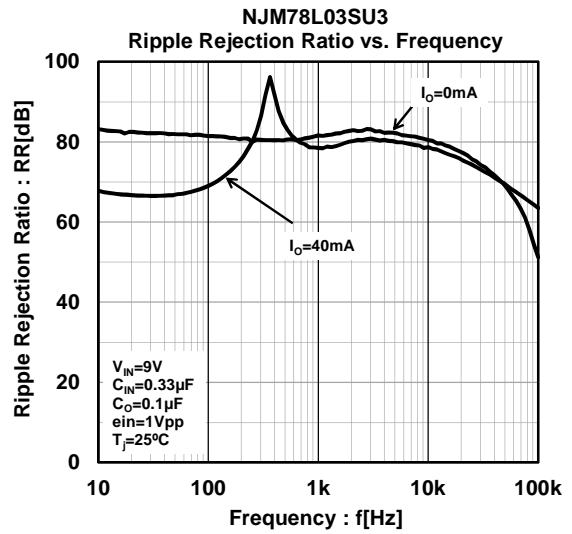
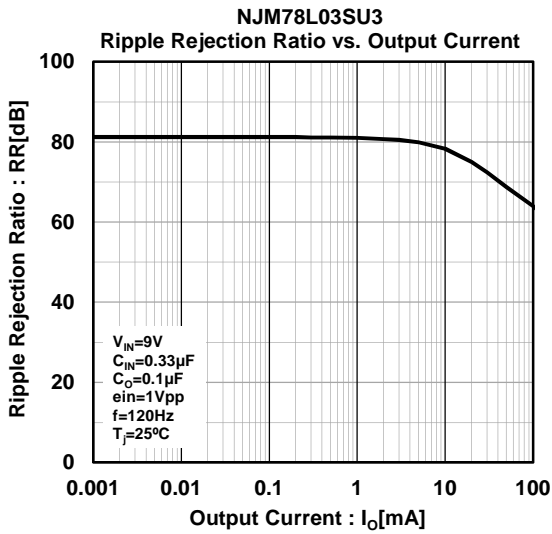

■ TYPICAL CHARACTERISTICS (5V)

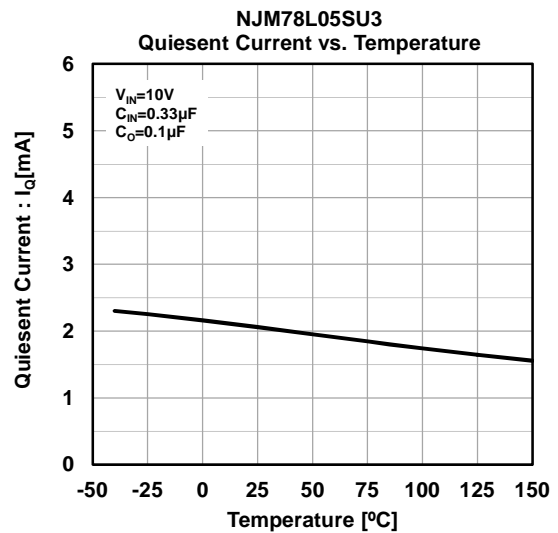
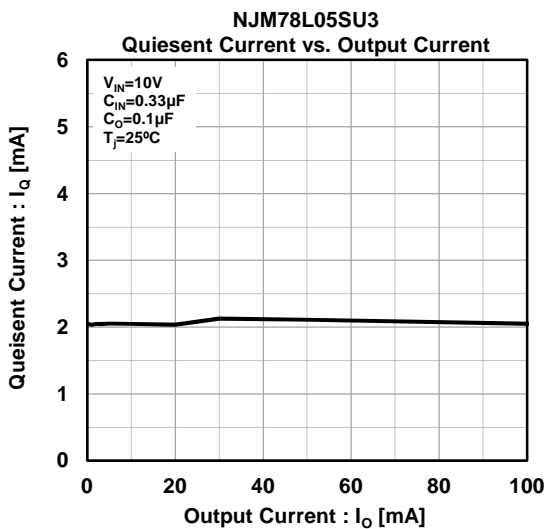
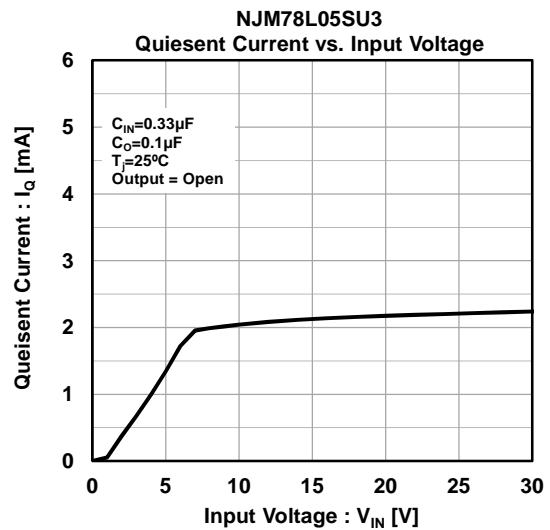
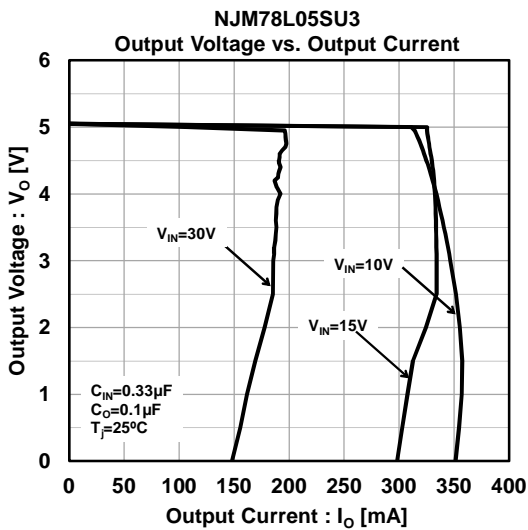
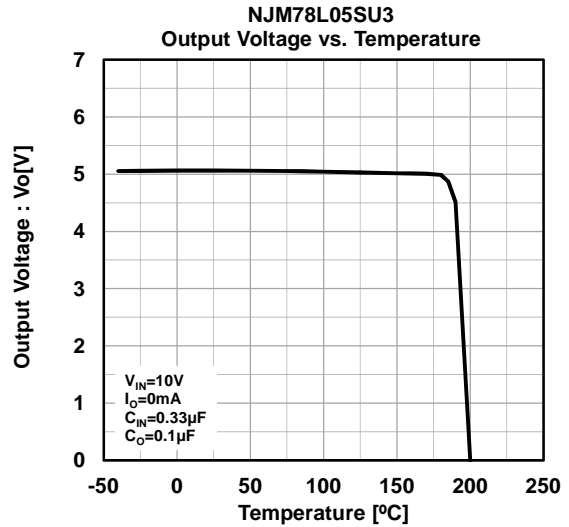
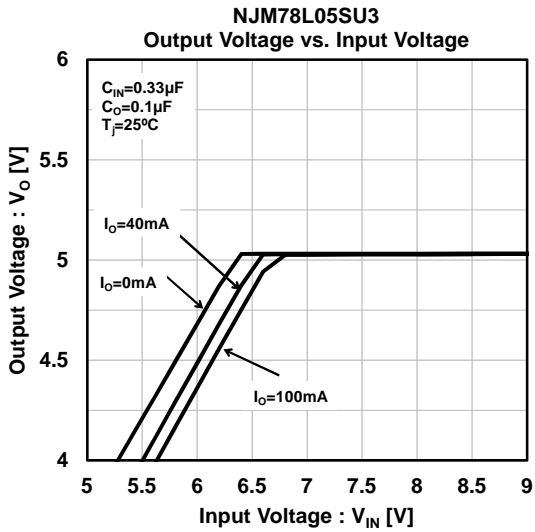

NJM78L00S

■ TYPICAL CHARACTERISTICS (5V)

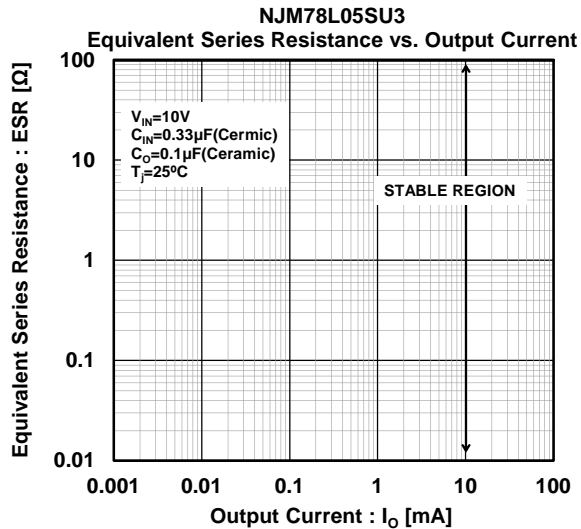
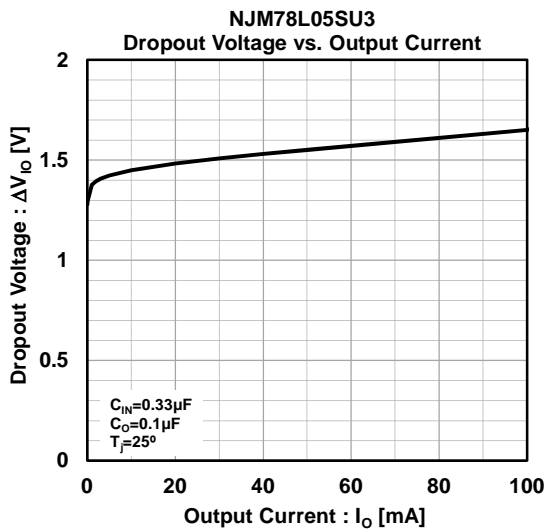
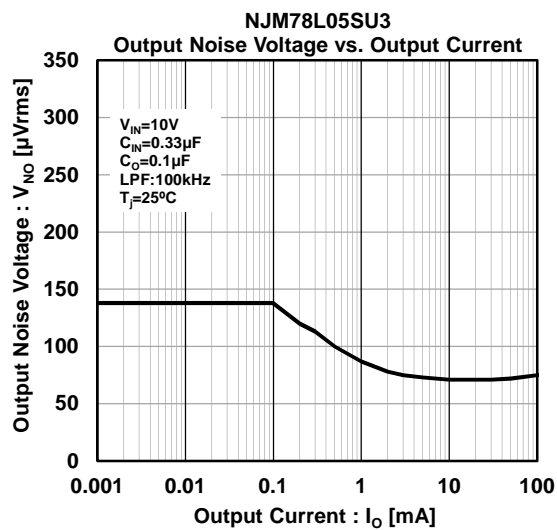
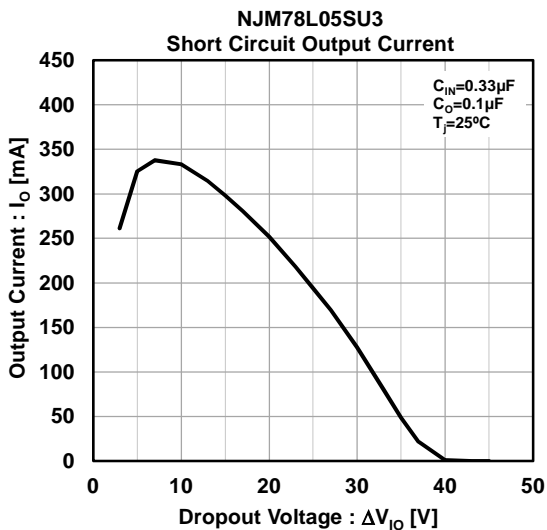
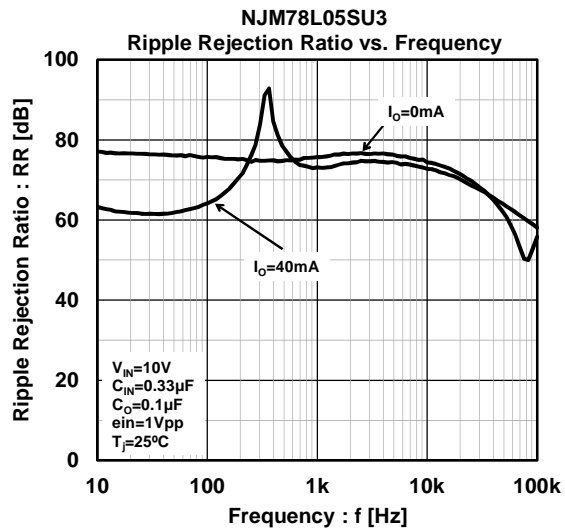
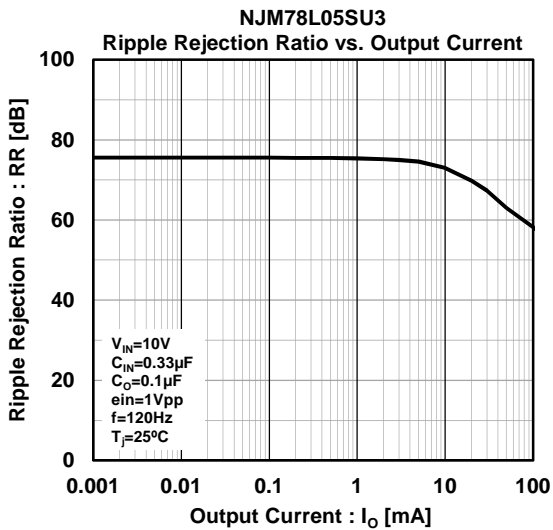

■ TYPICAL CHARACTERISTICS (15V)

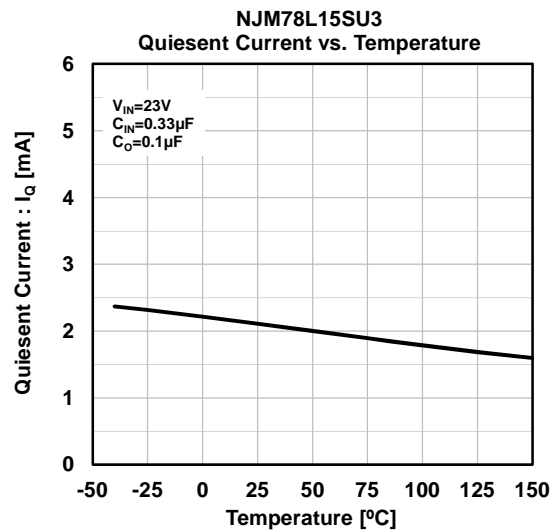
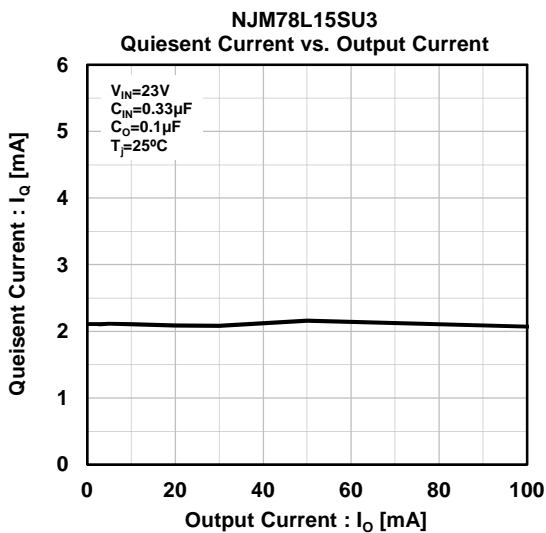
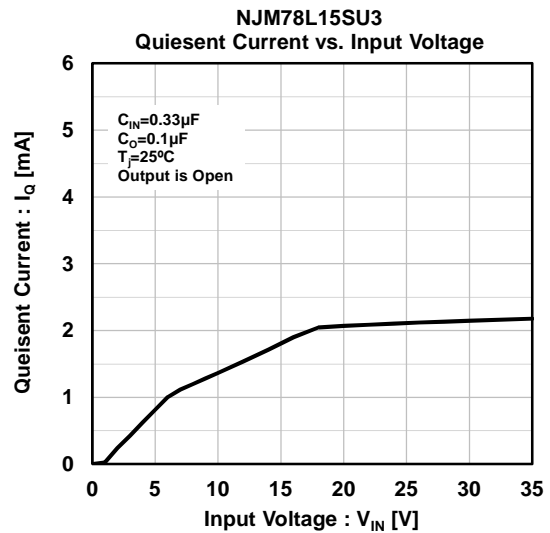
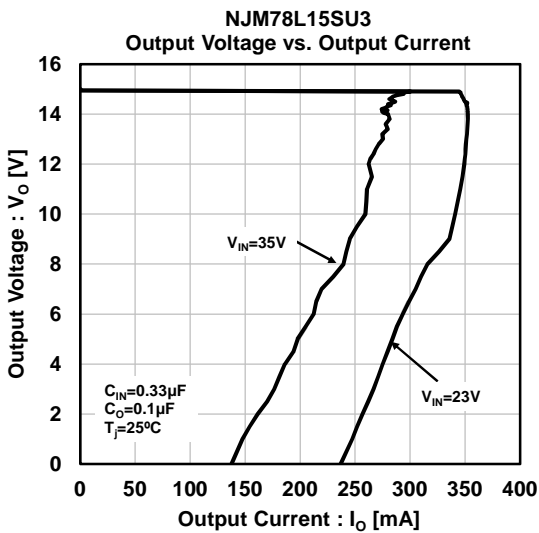
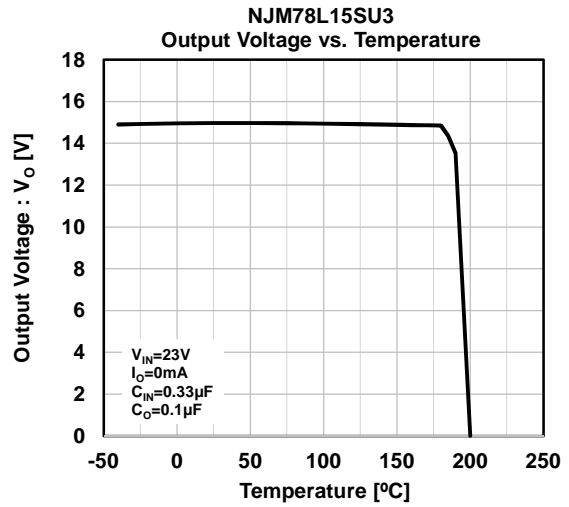
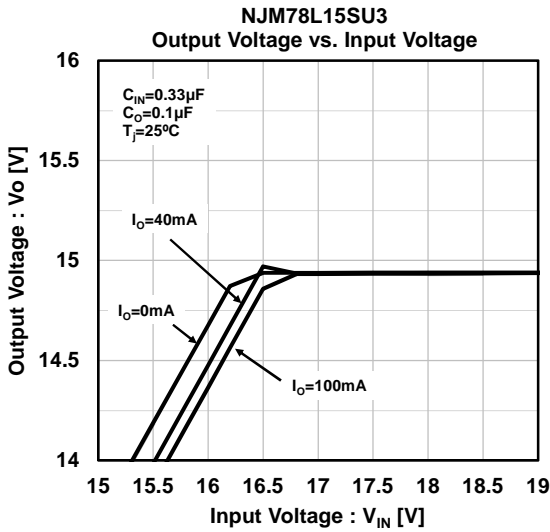

NJM78L00S

■ TYPICAL CHARACTERISTICS (15V)

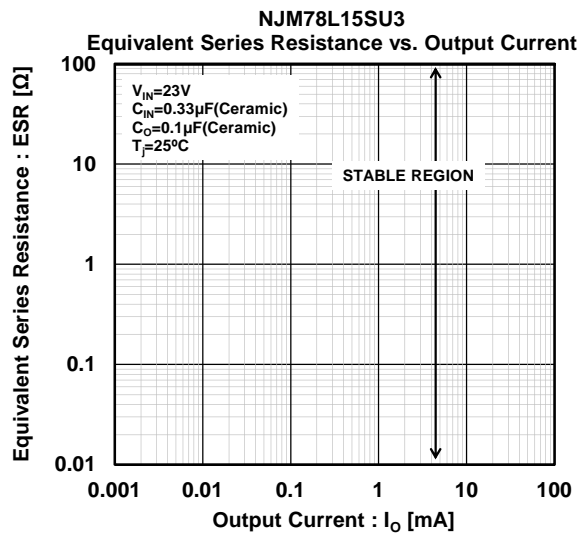
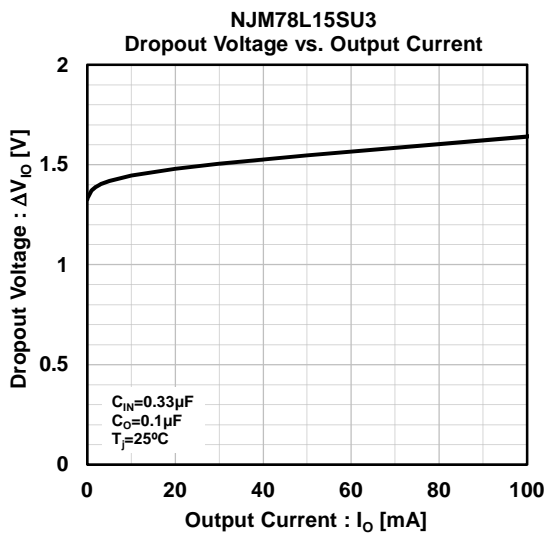
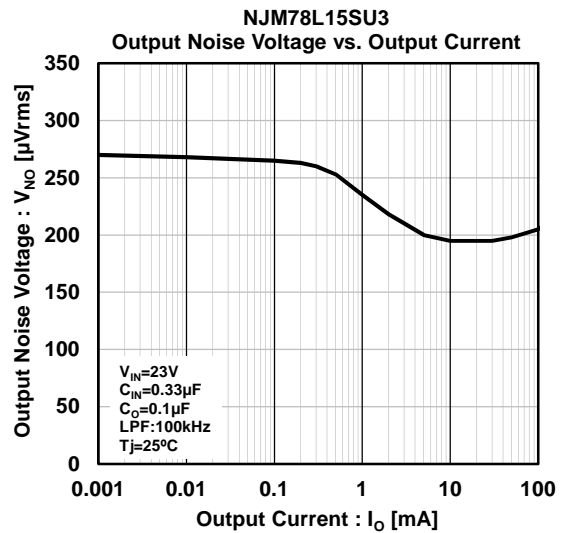
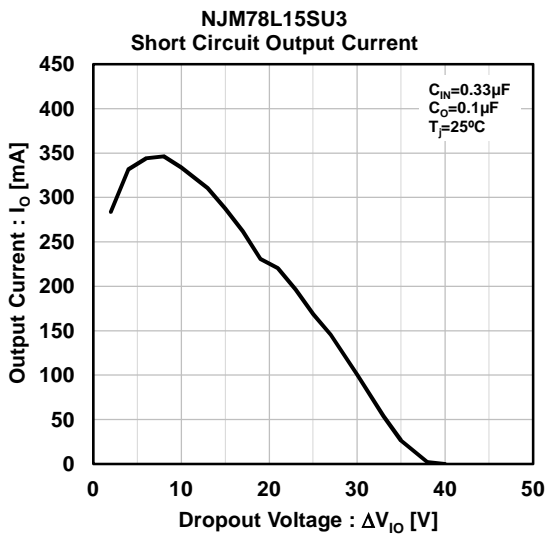
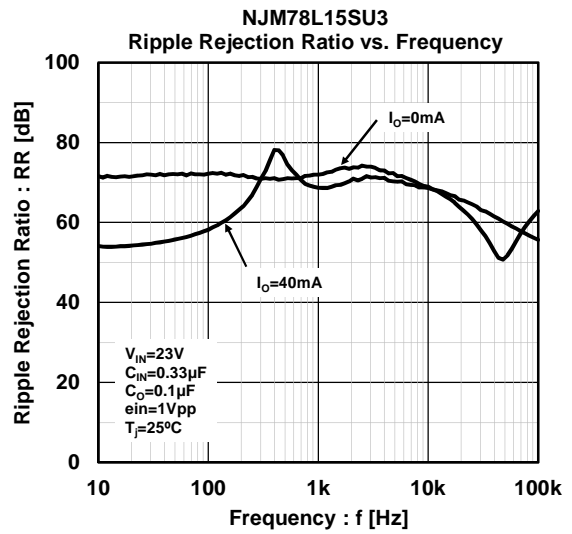
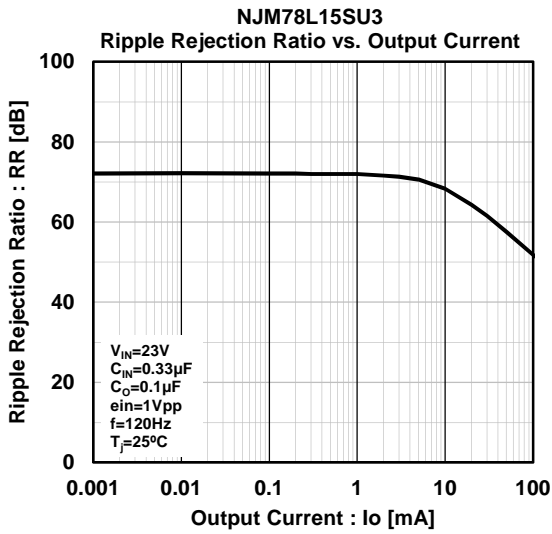

MEMO

[CAUTION]

The specifications on this databook are only given for information, without any guarantee as regards either mistakes or omissions. The application circuits in this databook are described only to show representative usages of the product and not intended for the guarantee or permission of any right including the industrial rights.