

Precision, JFET Input Operational Amplifier

FEATURES

- Low Input Offset Voltage $V_{IO}=400\mu\text{V}$ max.
 $V_{IO}=700\mu\text{V}$ max.
($T_a = -40^\circ\text{C}$ to $+125^\circ\text{C}$)
- Low Input Offset Voltage Drift $\Delta V_{IO}/\Delta T=5\mu\text{V}/^\circ\text{C}$ max.
($T_a = -40^\circ\text{C}$ to $+125^\circ\text{C}$)
- Low Supply Current $I_{CC}=1.3\text{mA}/\text{ch}$ typ.
- High Slew Rate $SR=20\text{V}/\mu\text{s}$ typ.
- Wide Bandwidth $f_t=7\text{MHz}$ typ.
- Low Noise $e_n=10\text{nV}/\sqrt{\text{Hz}}$ typ. (at $f=1\text{kHz}$)
- Low Input Bias Current $I_B=80\text{pA}$ max. (at $T_a=25^\circ\text{C}$)
- No Phase Reversal
- RF noise Immunity
- Guaranteed Temperature $T_{opr} = -40^\circ\text{C}$ to $+125^\circ\text{C}$
- Operating Voltage $V_{opr} = \pm 4.5\text{V}$ to $\pm 16\text{V}$
- Package

NJM8512	MSOP8 (VSP8) meet JEDEC MO-187-DA
NJM8513	SOP8 JEDEC 150 mil SSOP14

GENERAL DESCRIPTION

The NJM8512/NJM8513 are Dual/Quad high precision JFET input operational amplifier featuring low offset, low offset drift, low bias current, high slew rate, low noise and wide operating temperature range. The precision performance, high speed and low noise make the NJM8512/NJM8513 especially suitable for filter and amplification of high speed and small signal in instruments, automated test equipment, sensors and other precision applications.

APPLICATIONS

- Current Sensor
- Photodiode Amplification
- Reference Voltage Circuit
- Automatic Test Equipment

ELECTRICAL CHARACTERISTICS

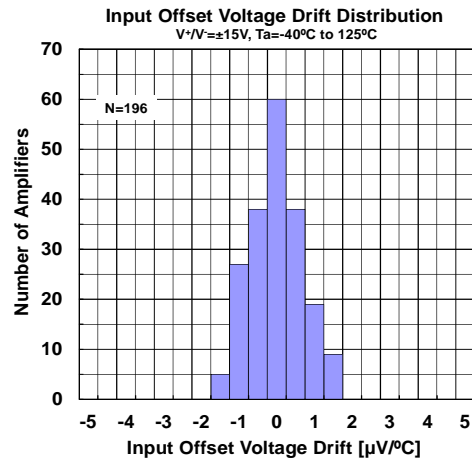
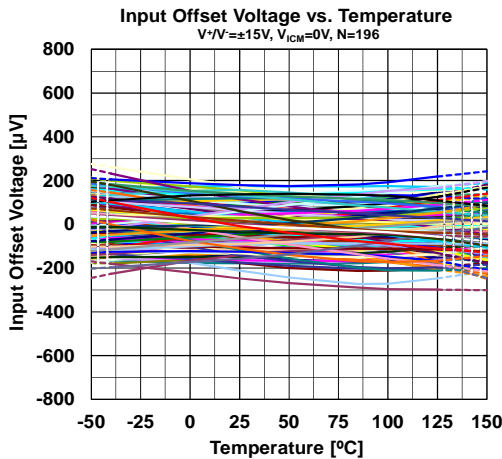

PIN CONFIGURATION

Pin Function	<p>(Top View)</p> <p>A OUTPUT 1, A -INPUT 2, A +INPUT 3, V- 4, V+ 8, B OUTPUT 7, B -INPUT 6, B +INPUT 5</p>		<p>(Top View)</p> <p>A OUTPUT 1, A -INPUT 2, A +INPUT 3, V+ 4, B +INPUT 5, B -INPUT 6, B OUTPUT 7, D OUTPUT 14, D -INPUT 13, D +INPUT 12, V- 11, C +INPUT 10, C -INPUT 9, C OUTPUT 8</p>
	Package Outline	MSOP8 SOP8	
PART NUMBER	NJM8512AR NJM8512BR	NJM8512AE NJM8512BE	NJM8513AV NJM8513BV

NJM8512/NJM8513

■ ABSOLUTE MAXIMUM RATINGS (Ta=25°C, unless otherwise noted.)

PARAMETER	SYMBOL	RATING	UNIT
Supply Voltage	V^+V^-	±18	V
Differential Input Voltage	V_{ID}	±36 (Note1)	V
Input Voltage	V_{IN}	$V^- - 0.3$ to $V^+ + 0.3$ (Note2)	V
Input Current	I_{IN}	±10(Note3)	mA
Power Dissipation MSOP8 (VSP8) SOP8 SSOP14	P_D	(2-layer / 4-layer) 595(Note4) / 805 (Note4) 690 (Note4) / 1000 (Note4) 490 (Note4) / 630 (Note4)	mW
Output Short-Circuit Duration		Infinite($T_a = 25^\circ$) (Note4)	
Operating Temperature Range	T_{opr}	-40 to +125	°C
Junction Temperature	T_{jmax}	+150	°C
Storage Temperature Range	T_{stg}	-65 to +150	°C

(Note1) Differential Input Voltage is the voltage difference between +INPUT and -INPUT.

(Note2) The normal operation will establish when any input is within the Common Mode Input Voltage Range of electrical characteristics.

(Note3) If the input voltage exceeds the supply voltage, the input current must be limited 10 mA or less by using a restriction resistance.

(Note4) 2-layer : EIA/JEDEC STANDARD Test board (76.2 x 114.3 x 1.6mm, 2layers, FR-4) mounting.

4-layer : EIA/JEDEC STANDARD Test board (76.2 x 114.3 x 1.6mm, 4layers, FR-4) mounting.

See Figure "Fig.1-1 : Power Dissipation Curve" when ambient temperature is over 25°C.

Figure1-A: Power Dissipation Derating Curve

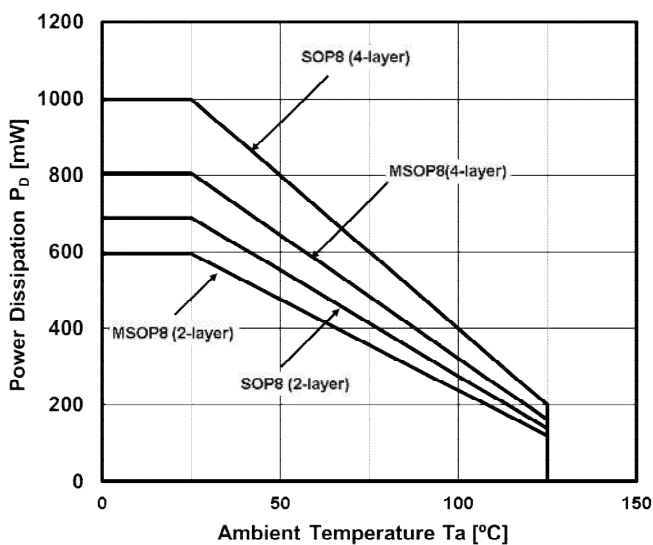
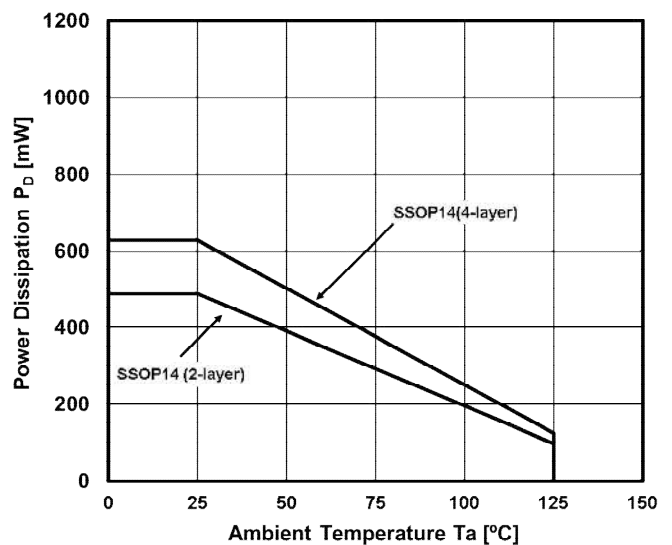

Figure1-B: Power Dissipation Derating Curve



■ RECOMMENDED OPERATING VOLTAGE (Ta=25°C)

PARAMETER	SYMBOL	RATING	MIN.	TYP.	MAX.	UNIT
Supply Voltage	V^+V^-		±4.5	-	±16	V

NJM8512/NJM8513

■ ELECTRICAL CHARACTERISTICS ($V^+ / V^- = \pm 15V$, $T_a = 25^\circ C$, $V_{ICM} = 0V$, unless otherwise noted.)

PARAMETER	SYMBOL	TEST CONDITION	MIN.	TYP.	MAX.	UNIT
Input Characteristics						
Input Offset Voltage						
NJM8512Bx / NJM8513Bx	V_{IO1}		-	80	400	μV
	V_{IO2}	$T_a = -40^\circ C$ to $125^\circ C$	-	-	700	μV
NJM8512Ax / NJM8513Ax	V_{IO1}		-	80	800	μV
	V_{IO2}	$T_a = -40^\circ C$ to $125^\circ C$	-	-	1400	μV
Input Offset Voltage Drift						
NJM8512Bx / NJM8513Bx	$\Delta V_{IO} / \Delta T$	$T_a = -40^\circ C$ to $125^\circ C$	-	0.8	5	$\mu V / ^\circ C$
	$\Delta V_{IO} / \Delta T$	$T_a = -40^\circ C$ to $125^\circ C$	-	1	9	$\mu V / ^\circ C$
Input Bias Current	I_{B1}		-	25	80	pA
	I_{B2}	$T_a = -40^\circ C$ to $125^\circ C$	-	-	35	nA
Input Offset Current	I_{IO1}		-	6	75	pA
	I_{IO2}	$T_a = -40^\circ C$ to $125^\circ C$	-	-	2	nA
Common Mode Input Voltage Range	V_{ICM1}	CMR 86dB	-12.5	-	+12.5	V
	V_{ICM2}	CMR 80dB, $T_a = -40^\circ C$ to $125^\circ C$	-12.5	-	+12.5	V
Common Mode Rejection Ratio	CMR1	$V_{CM} = -12.5V$ to $+12.5V$	86	108	-	dB
	CMR2	$V_{CM} = -12.5V$ to $+12.5V$, $T_a = -40^\circ C$ to $125^\circ C$	80	-	-	dB
	CMR3	$V_{CM} = -10V$ to $+10V$	100	120	-	dB
Voltage Gain	A_{V1}	$R_L = 2k\Omega$, $V_O = -13.5V$ to $+13.5V$	90	100	-	dB
	A_{V2}	$R_L = 2k\Omega$, $V_O = -13.5V$ to $+13.5V$, $T_a = -40^\circ C$ to $125^\circ C$	82	-	-	dB
	A_{V3}	$R_L = 10k\Omega$, $V_O = -13.5V$ to $+13.5V$	98	106	-	dB
Input capacitance	C_{IN}		-	10	-	pF
Channel Separation	CS	DC	-	125	-	dB
Output Characteristics						
Maximum Output Voltage	V_{OH1}	$R_L = 10k\Omega$, $T_a = -40^\circ C$ to $125^\circ C$	+14.0	+14.2	-	V
	V_{OL1}	$R_L = 10k\Omega$, $T_a = -40^\circ C$ to $125^\circ C$	-	-14.9	-14.6	V
	V_{OH2}	$R_L = 2k\Omega$, $T_a = -40^\circ C$ to $125^\circ C$	+13.8	+14.1	-	V
	V_{OL2}	$R_L = 2k\Omega$, $T_a = -40^\circ C$ to $125^\circ C$	-	-14.8	-14.4	V
	V_{OH31}	$R_L = 600\Omega$	+13.5	+13.9	-	V
	V_{OH32}	$R_L = 600\Omega$, $T_a = -40^\circ C$ to $125^\circ C$	+11.4	-	-	V
	V_{OL41}	$R_L = 600\Omega$	-	-14.3	-13.8	V
	V_{OL42}	$R_L = 600\Omega$, $T_a = -40^\circ C$ to $125^\circ C$	-	-	-12.1	V
Supply Characteristics						
Supply Current (ALL Amps) : NJM8512	I_{CC1}	$G_V = +1$, $R_L =$	-	2.6	3.0	mA
	I_{CC2}	$G_V = +1$, $R_L =$, $T_a = -40^\circ C$ to $125^\circ C$	-	-	3.3	mA
Supply Current (ALL Amps) : NJM8513	I_{CC1}	$G_V = +1$, $R_L =$	-	5.2	6.0	mA
	I_{CC2}	$G_V = +1$, $R_L =$, $T_a = -40^\circ C$ to $125^\circ C$	-	-	6.6	mA
Supply Voltage Rejection Ratio	SVR1	$V^+ / V^- = \pm 4.5V$ to $\pm 16V$	86	110	-	dB
	SVR2	$V^+ / V^- = \pm 4.5V$ to $\pm 16V$, $T_a = -40^\circ C$ to $125^\circ C$	80	-	-	dB
Dynamic Performance						
Unity Gain Frequency	fT	$G_V = +100$, $R_L = 2k\Omega$, $C_L = 10pF$	-	7	-	MHz
Slew Rate	+SR	RISE, $G_V = +1$, $V_{IN} = 2V_{pp}$, $R_L = 2k\Omega$	-	20	-	V/ μs
	-SR	FALL, $G_V = +1$, $V_{IN} = 2V_{pp}$, $R_L = 2k\Omega$	-	20	-	V/ μs
Settling Time	ts1	To 0.1%, 0V to 10V step, $G_V = +1$	-	0.7	-	μs
	ts2	To 0.01%, 0V to 10V step, $G_V = +1$	-	1.0	-	μs
Phase Margin	Φ_M		-	70	-	deg
Total Harmonic Distortion	THD	$f_o = 1kHz$, $G_V = +1$, $R_L = 2k\Omega$	-	0.0004	-	%
Noise Performance						
Input Voltage Noise Density	V_{NI}	$f_o = 0.1Hz$ to $10Hz$	-	0.9	-	μV_{pp}
	en1	$f_o = 10Hz$	-	20	-	nV/ Hz
	en2	$f_o = 100Hz$	-	11	-	nV/ Hz
	en3	$f_o = 1kHz$	-	10	-	nV/ Hz
	en4	$f_o = 10kHz$	-	9	-	nV/ Hz

(Note) Measurement is to be conducted in pulse testing.

NJM8512/NJM8513

■ ELECTRICAL CHARACTERISTICS ($V^+V^- = \pm 5V$, $T_a = 25^\circ C$, $V_{ICM} = 0V$, unless otherwise noted.)

PARAMETER	SYMBOL	TEST CONDITION	MIN.	TYP.	MAX.	UNIT
Input Characteristics						
Input Offset Voltage						
NJM8512Bx / NJM8513Bx	V_{IO1}		-	80	400	μV
	V_{IO2}	$T_a = -40^\circ C$ to $125^\circ C$	-	-	700	μV
NJM8512Ax / NJM8513Ax	V_{IO1}		-	80	800	μV
	V_{IO2}	$T_a = -40^\circ C$ to $125^\circ C$	-	-	1400	μV
Input Offset Voltage Drift						
NJM8512Bx / NJM8513Bx	$\Delta V_{IO}/\Delta T$	$T_a = -40^\circ C$ to $125^\circ C$	-	0.8	5	$\mu V/^\circ C$
NJM8512Ax / NJM8513Ax	$\Delta V_{IO}/\Delta T$	$T_a = -40^\circ C$ to $125^\circ C$	-	1	9	$\mu V/^\circ C$
Input Bias Current						
	I_{B1}		-	21	75	pA
	I_{B2}	$T_a = -40^\circ C$ to $125^\circ C$	-	-	31	nA
Input Offset Current						
	I_{IO1}		-	5	50	pA
	I_{IO2}	$T_a = -40^\circ C$ to $125^\circ C$	-	-	2	nA
Common Mode Input Voltage Range						
	V_{ICM1}	CMR 86dB	-2	-	+2.5	V
	V_{ICM2}	CMR 80dB, $T_a = -40^\circ C$ to $125^\circ C$	-2	-	+2.5	V
Common Mode Rejection Ratio						
	CMR1	$V_{CM} = -2V$ to $+2.5V$	86	108	-	dB
	CMR2	$V_{CM} = -2V$ to $+2.5V$, $T_a = -40^\circ C$ to $125^\circ C$	80	-	-	dB
	CMR3	$V_{CM} = -1V$ to $+2V$	92	113	-	dB
Voltage Gain						
	A_{V1}	$R_L = 2k\Omega$, $V_O = -3V$ to $+3V$	85	93	-	dB
	A_{V2}	$R_L = 2k\Omega$, $V_O = -3V$ to $+3V$, $T_a = -40^\circ C$ to $125^\circ C$	80	-	-	dB
	A_{V3}	$R_L = 10k\Omega$, $V_O = -3V$ to $+3V$	90	100	-	dB
Input capacitance	C_{IN}		-	10	-	pF
Channel Separation	CS	DC	-	125	-	dB
Output Characteristics						
Maximum Output Voltage						
	V_{OH1}	$R_L = 10k\Omega$, $T_a = -40^\circ C$ to $125^\circ C$	+4.1	+4.3	-	V
	V_{OL1}	$R_L = 10k\Omega$, $T_a = -40^\circ C$ to $125^\circ C$	-	-4.9	-4.7	V
	V_{OH2}	$R_L = 2k\Omega$, $T_a = -40^\circ C$ to $125^\circ C$	+3.9	+4.2	-	V
	V_{OL2}	$R_L = 2k\Omega$, $T_a = -40^\circ C$ to $125^\circ C$	-	-4.9	-4.5	V
	V_{OH31}	$R_L = 600\Omega$	+3.7	+4.1	-	V
	V_{OH32}	$R_L = 600\Omega$, $T_a = -40^\circ C$ to $125^\circ C$	+3.6	-	-	V
	V_{OL41}	$R_L = 600\Omega$	-	-4.8	-4.3	V
	V_{OL42}	$R_L = 600\Omega$, $T_a = -40^\circ C$ to $125^\circ C$	-	-	-4.2	V
Supply Characteristics						
Supply Current (ALL Amps) : NJM8512						
	I_{CC1}	$G_V = +1$, $R_L =$	-	2.0	3.0	mA
	I_{CC2}	$G_V = +1$, $R_L =$, $T_a = -40^\circ C$ to $125^\circ C$	-	-	3.3	mA
Supply Current (ALL Amps) : NJM8513						
	I_{CC1}	$G_V = +1$, $R_L =$	-	4.0	6.0	mA
	I_{CC2}	$G_V = +1$, $R_L =$, $T_a = -40^\circ C$ to $125^\circ C$	-	-	6.6	mA
Dynamic Performance						
Unity Gain Frequency	fT	$G_V = +100$, $R_L = 2k\Omega$, $C_L = 10pF$	-	7	-	MHz
Slew Rate						
	+SR	RISE, $G_V = +1$, $V_{IN} = 2V_{pp}$, $R_L = 2k\Omega$	-	18	-	V/ μs
	-SR	FALL, $G_V = +1$, $V_{IN} = 2V_{pp}$, $R_L = 2k\Omega$	-	18	-	V/ μs
Settling Time	ts1	To 0.1%, 0V to 4V step, $G_V = +1$	-	0.5	-	μs
Phase Margin	Φ_M		-	65	-	deg
Total Harmonic Distortion	THD	f _o =1kHz, $G_V = +1$, $R_L = 2k\Omega$	-	0.0005	-	%
Noise Performance						
Input Voltage Noise Density						
	V_{NI}	f _o =0.1Hz to 10Hz	-	0.9	-	μV_{pp}
	en1	f _o =10Hz	-	20	-	nV/ Hz
	en2	f _o =100Hz	-	11	-	nV/ Hz
	en3	f _o =1kHz	-	10	-	nV/ Hz
	en4	f _o =10kHz	-	9	-	nV/ Hz

(Note) Measurement is to be conducted in pulse testing.

ELECTRICAL CHARACTERISTICS

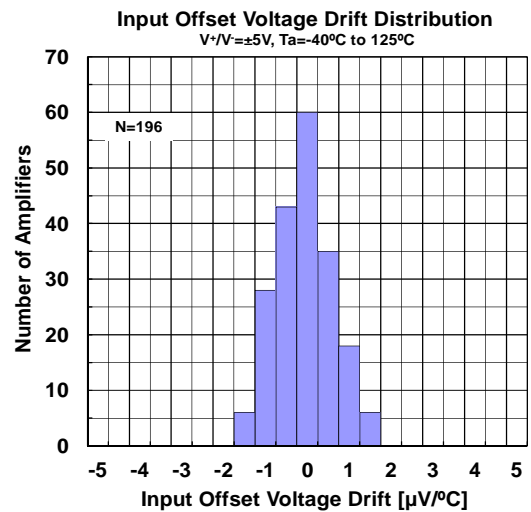
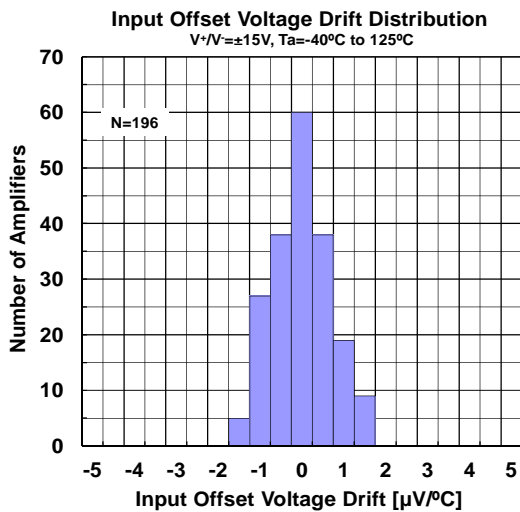
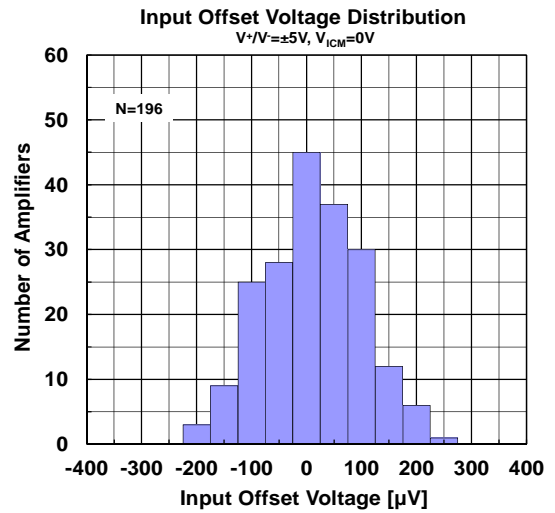
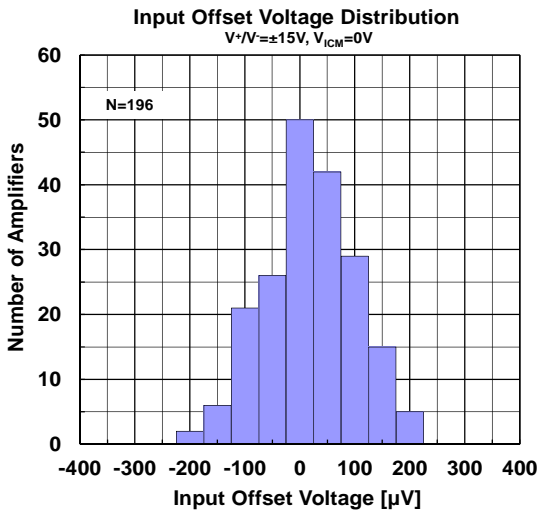
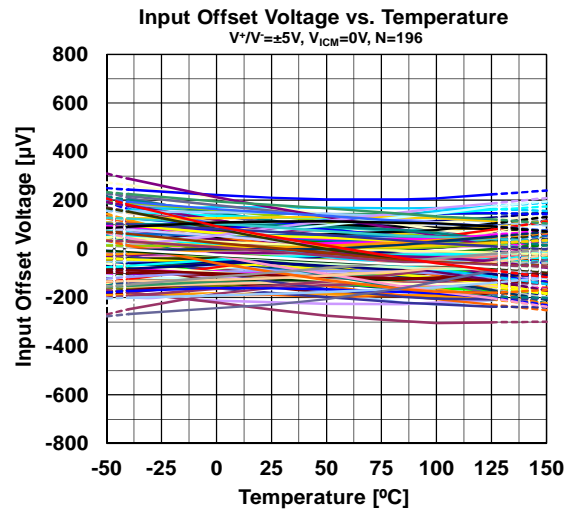
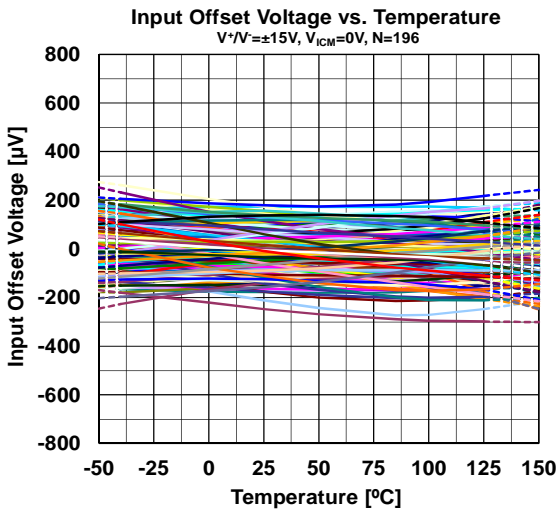

NJM8512/NJM8513

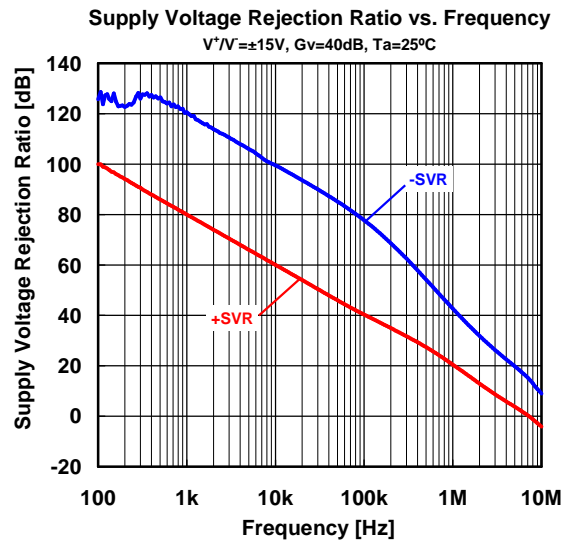
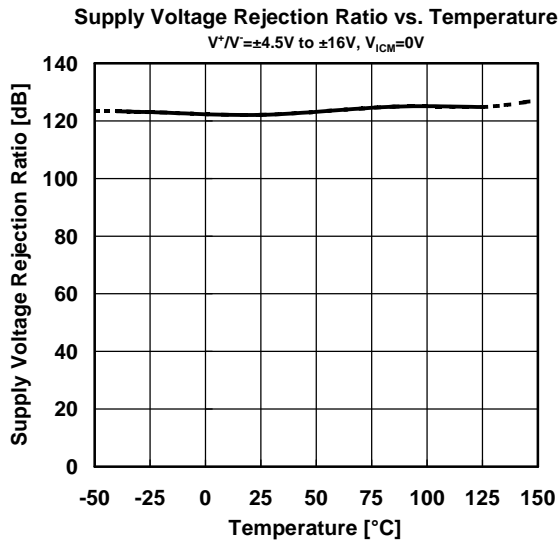
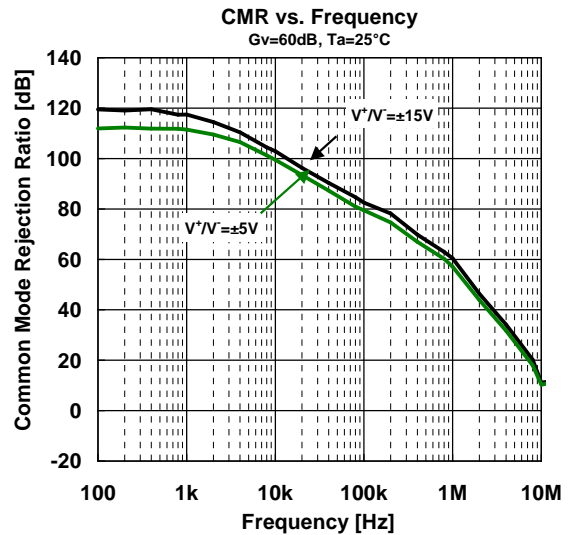
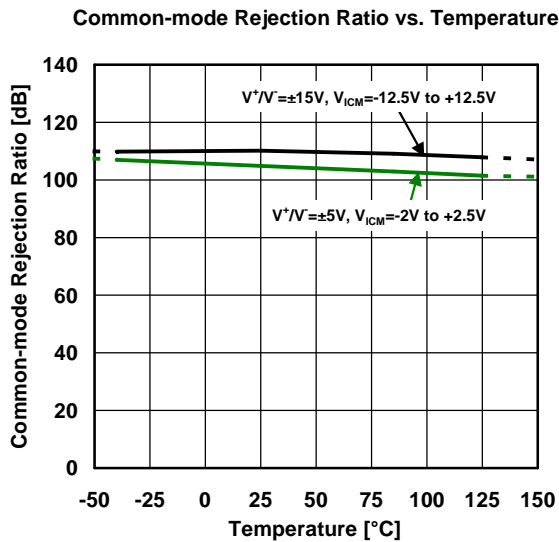
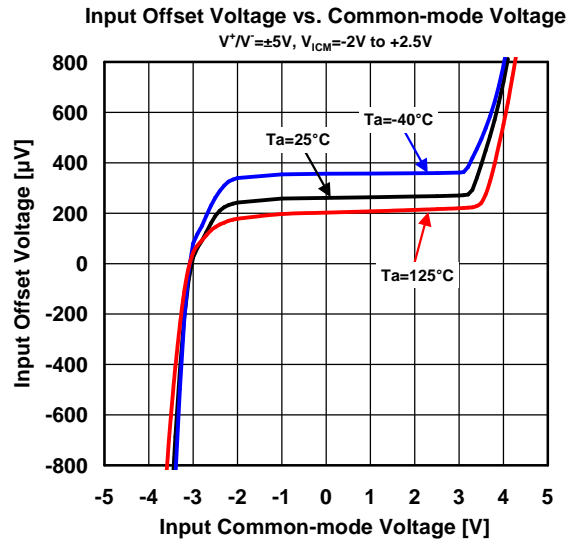
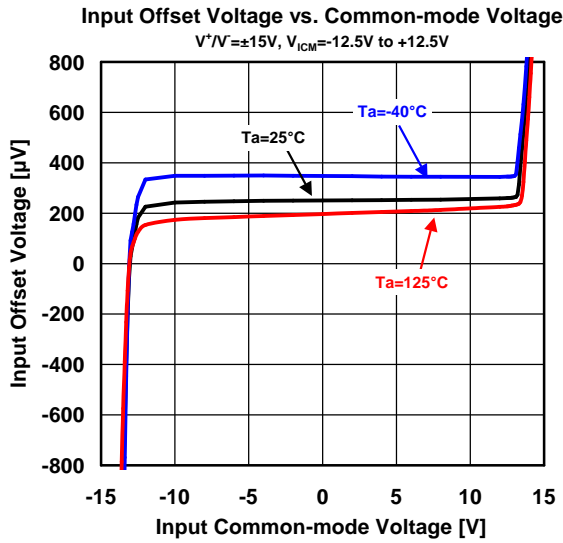

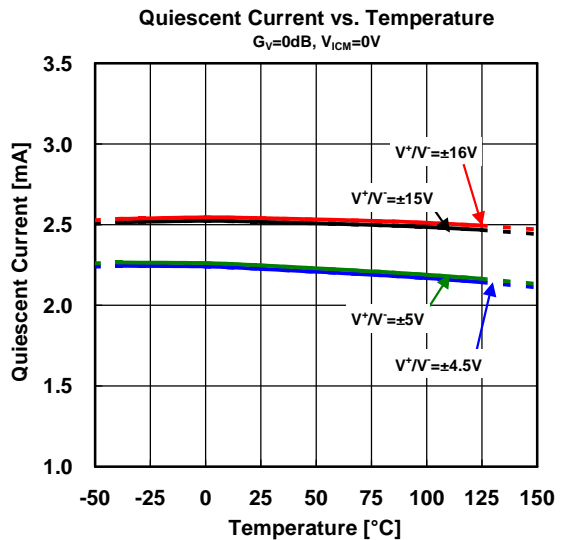
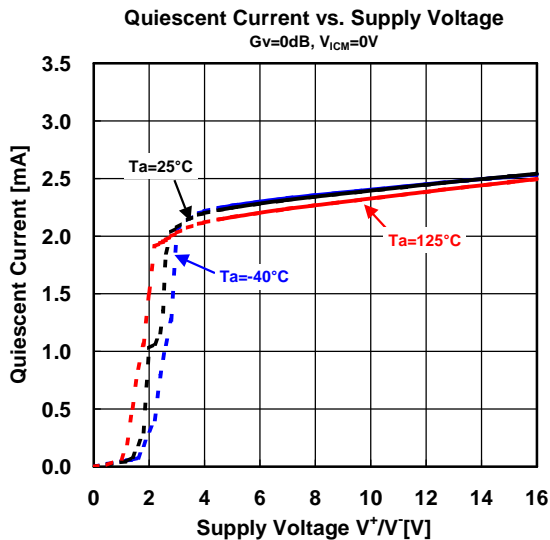
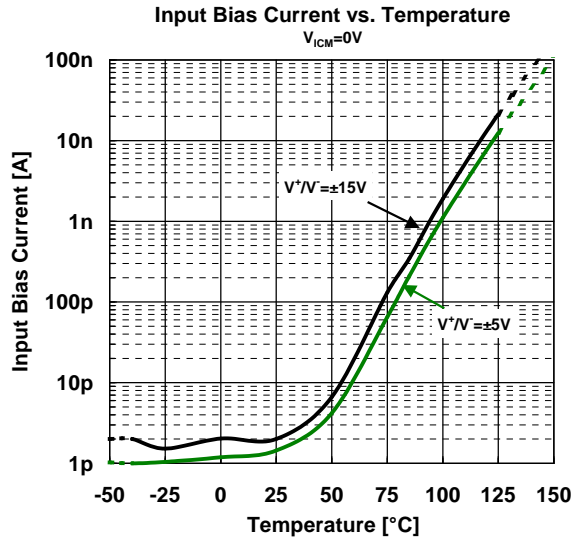
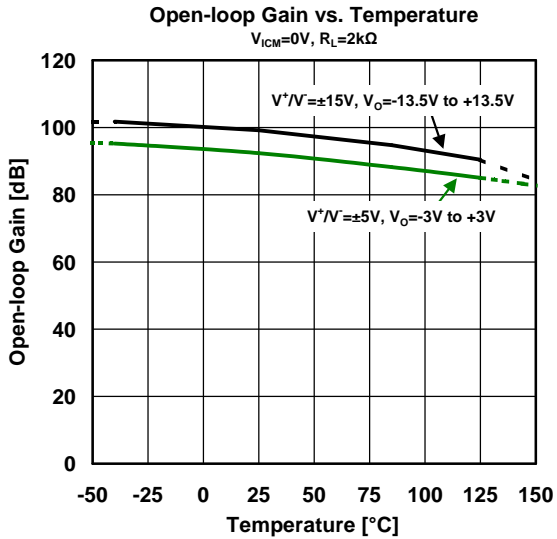
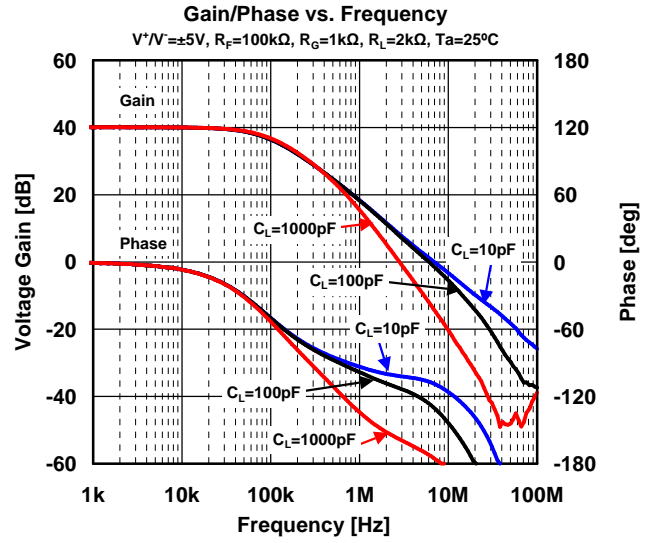
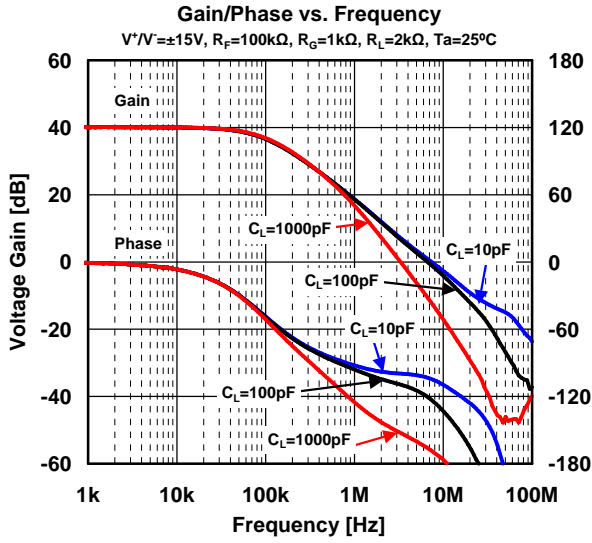

NJM8512/NJM8513

Maximum Output Voltage vs. Load Resistance

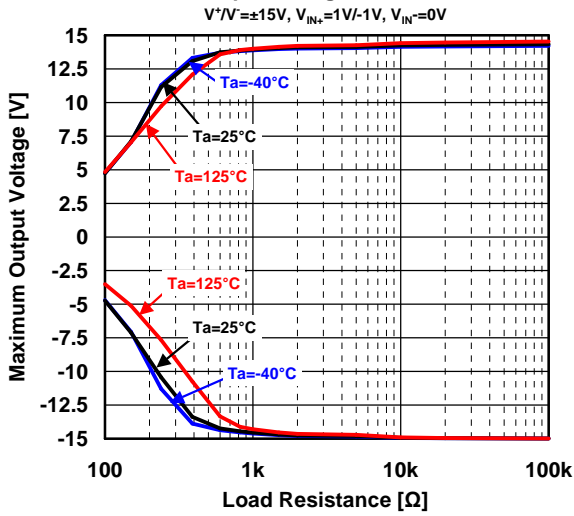

Maximum Output Voltage vs. Load Resistance

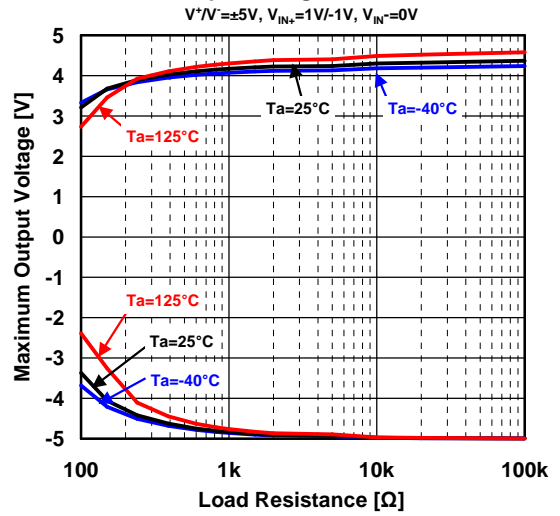

Maximum Output Voltage vs. Temperature

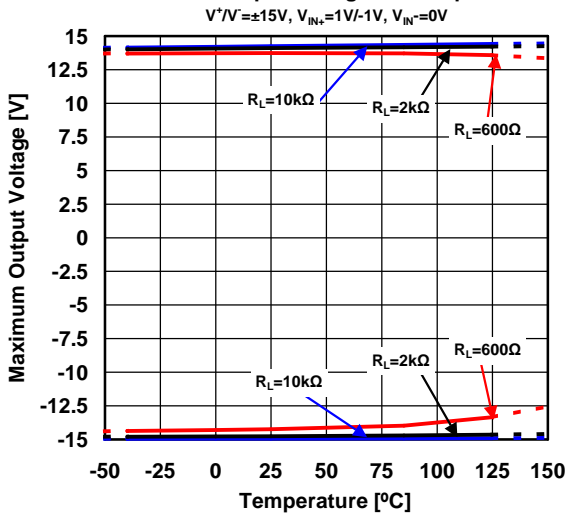

Maximum Output Voltage vs. Temperature

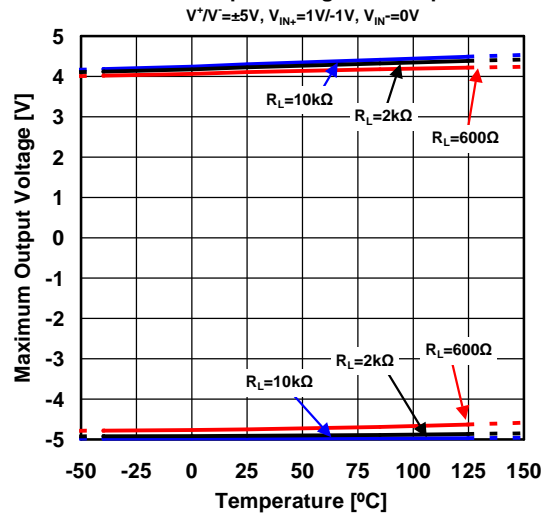

Maximum Output Voltage vs. Output Current

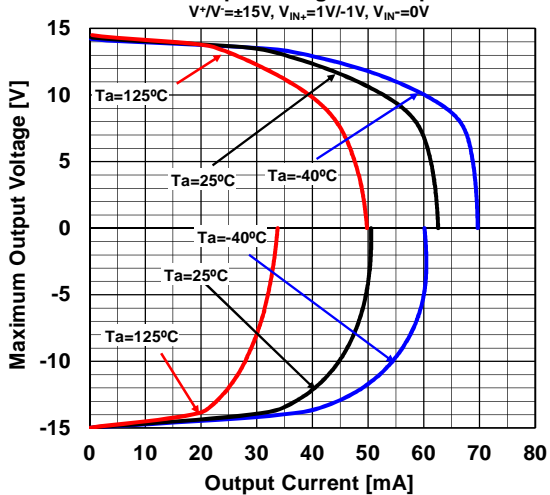

Maximum Output Voltage vs. Output Current

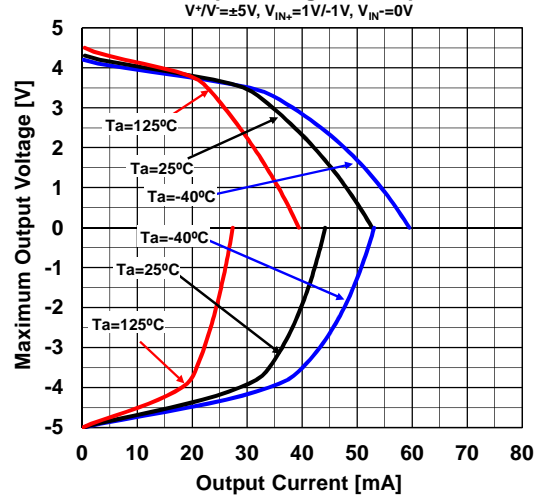

Small-Signal Step Response (Road Capacitance)

$V^+/V^- = \pm 15V$, $G_v = 0dB$, $V_{IN} = 1V_{pp}$, $R_L = 2k\Omega$, $T_a = 25^\circ C$

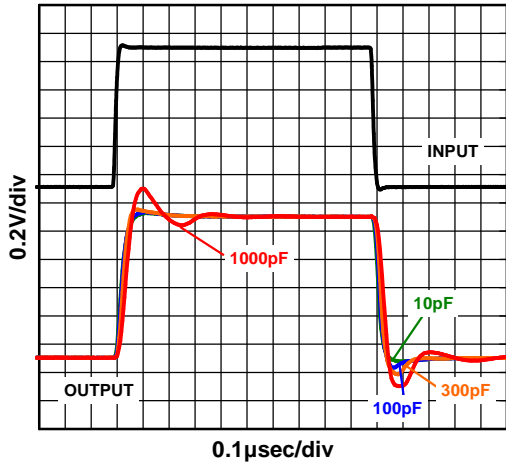

Small-Signal Step Response (Temperature)

$V^+/V^- = \pm 15V$, $G_v = 0dB$, $V_{IN} = 1V_{pp}$, $R_L = 2k\Omega$, $C_L = 10pF$

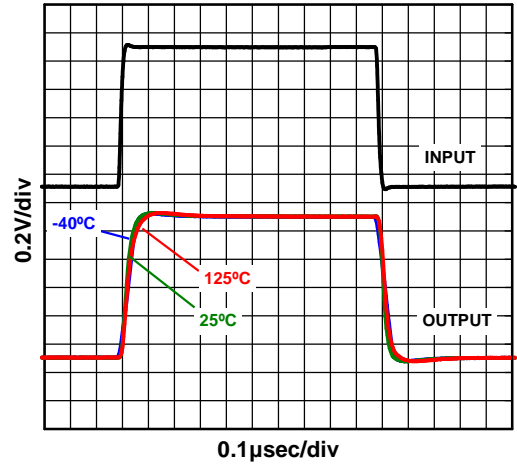

Large Signal Step Response

$V^+/V^- = \pm 15V$, $G_v = 0dB$, $V_{IN} = 10V_{pp}$, $R_L = 2k\Omega$

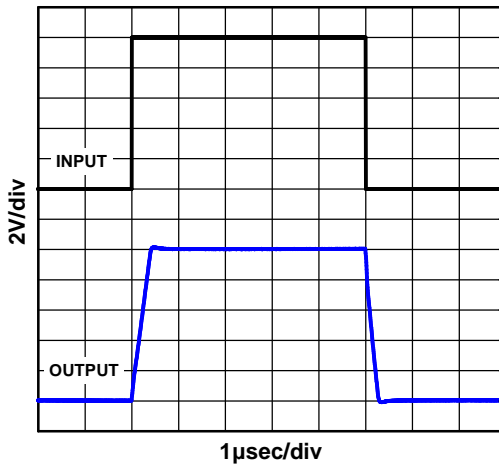

Slew Rate vs. Temperature

$V^+/V^- = \pm 15V$, $V_{IN} = 2V_{pp}$, $f = 100kHz$, $G_v = 0dB$, $C_L = 10pF$, $R_L = 2k\Omega$

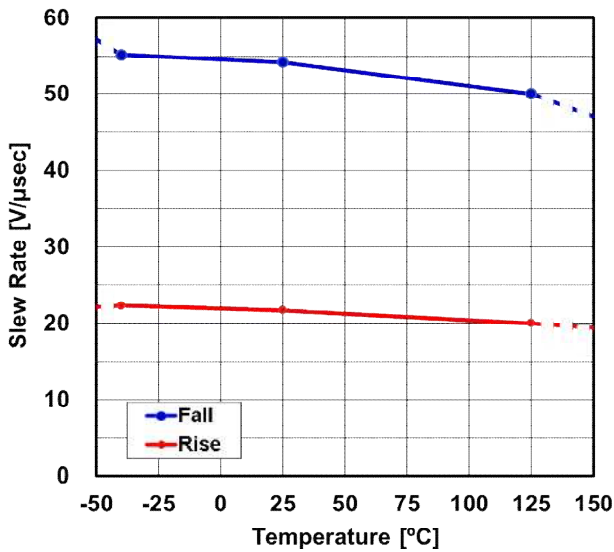

Slew Rate vs. Temperature

$V^+/V^- = \pm 5V$, $V_{IN} = 2V_{pp}$, $f = 100kHz$, $G_v = 0dB$, $C_L = 10pF$, $R_L = 2k\Omega$

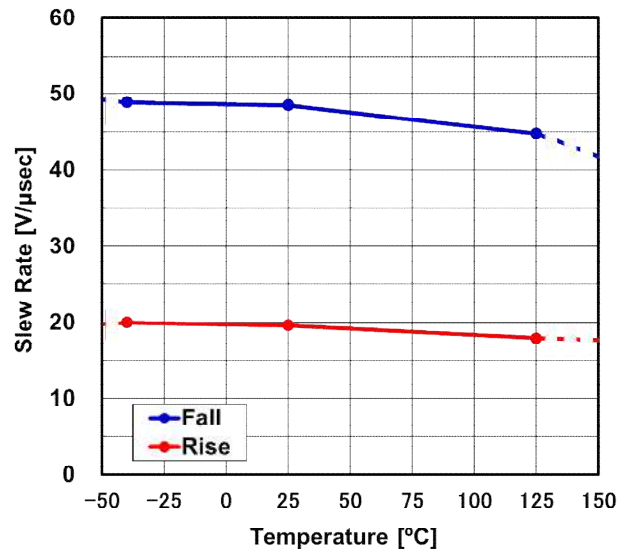

NJM8512/NJM8513

1Hz to 100Hz Input Voltage Noise
 $V^*V = \pm 15V$, 1 to 100Hz BPF

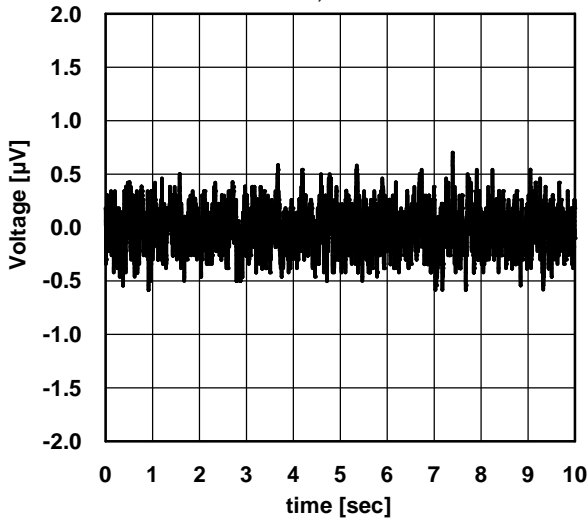

Input Voltage Noise Density vs. Frequency
 $G_v = 40dB$, $R_G = 100\Omega$, $R_L = 10k\Omega$, $T_a = 25^\circ C$

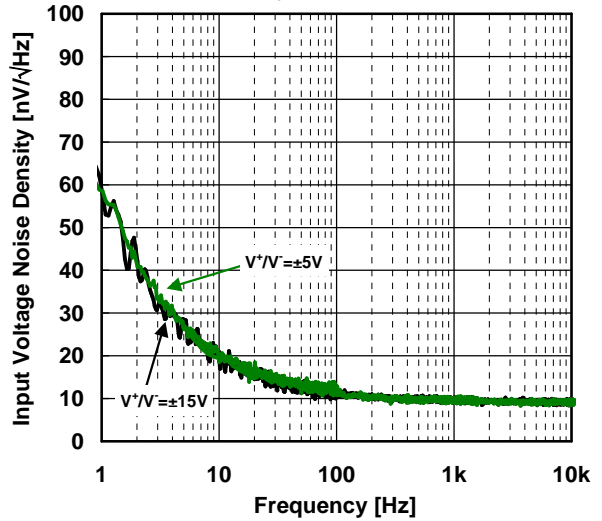

THD + Noise vs. Output Voltage
 $V^*V = \pm 15V$, $A_v = +1$, $R_L = 2k\Omega$, $T_a = 25^\circ C$

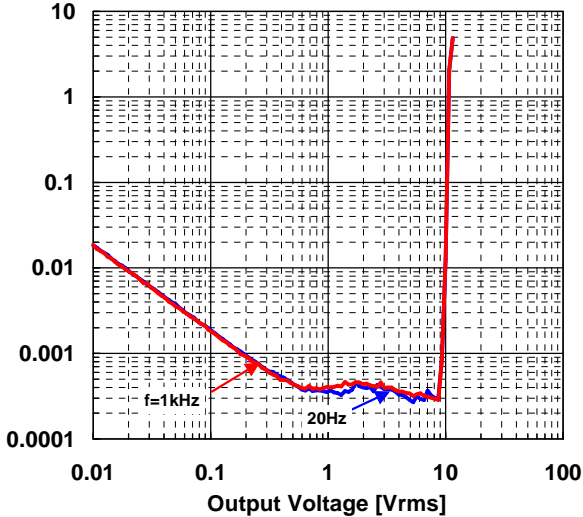

THD + Noise vs. Output Voltage
 $V^*V = \pm 5V$, $A_v = +1$, $R_L = 2k\Omega$, $T_a = 25^\circ C$

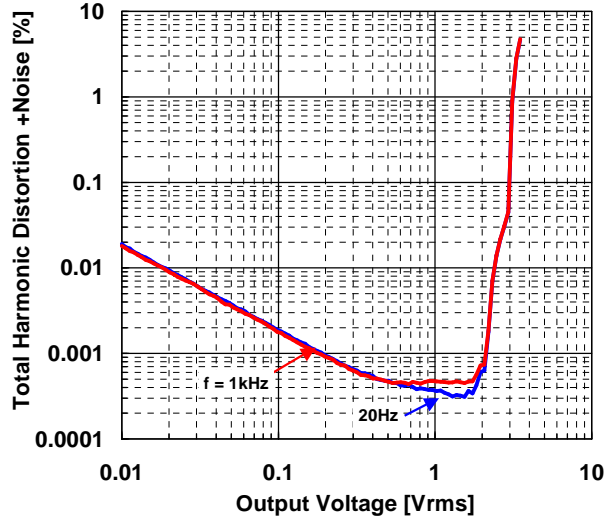

Channel Separation vs. Frequency
 $V^*V = \pm 15V$, $R_F = 100k\Omega$, $R_S = 1k\Omega$, $T_a = 25^\circ C$,
 $R_L = 2k\Omega$ to $0V$, $V_o = 5V_{rms}$

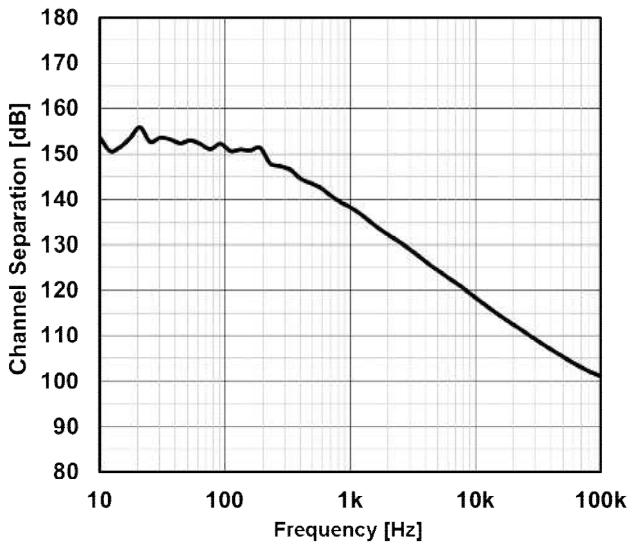

Channel Separation vs. Frequency
 $V^*V = \pm 5V$, $R_F = 100k\Omega$, $R_S = 1k\Omega$, $T_a = 25^\circ C$,
 $R_L = 2k\Omega$ to $0V$, $V_o = 1V_{rms}$

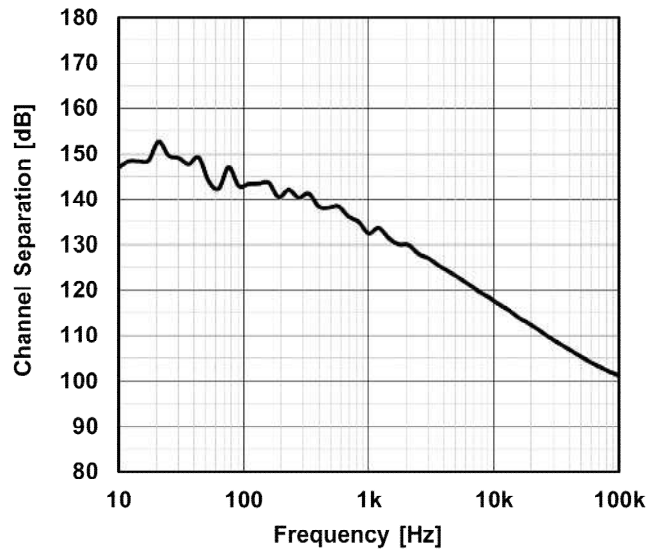

Short Circuit Output Current

$V^+/V^- = \pm 15V$, $V_{IN+} = 0V$, $V_O = 0V$, $T_a = 25^\circ C$

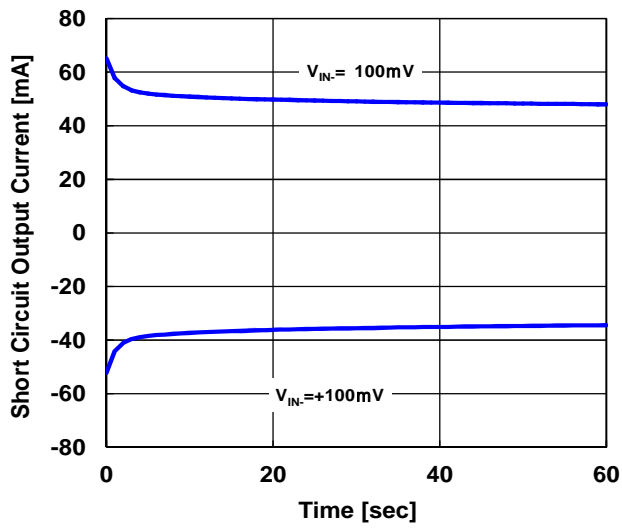

Input Voltage vs. Output Voltage

$V^+/V^- = \pm 5V$, $A_v = 0dB$, $R_L = 10k\Omega$

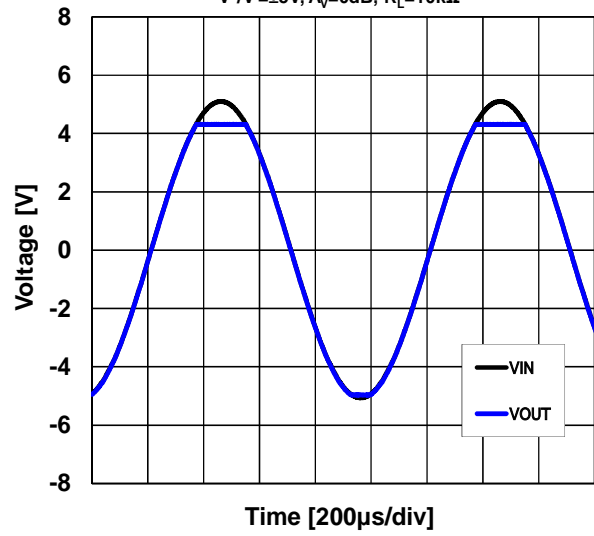

NJM8512/NJM8513

■PACKAGE DIMENSIONS

MSOP8(VSP8)

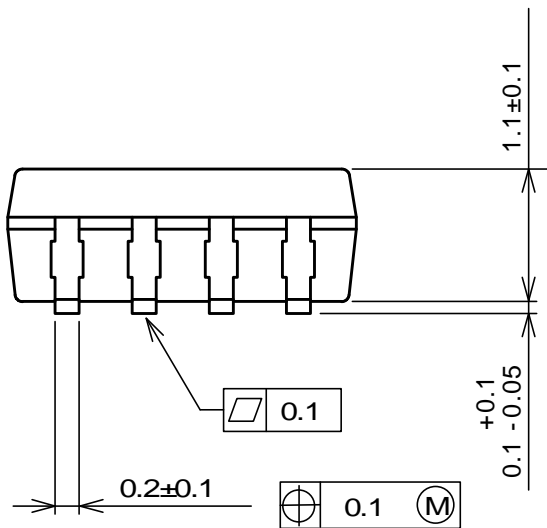
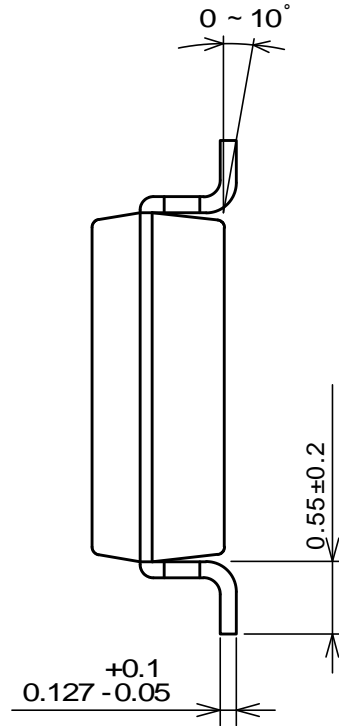
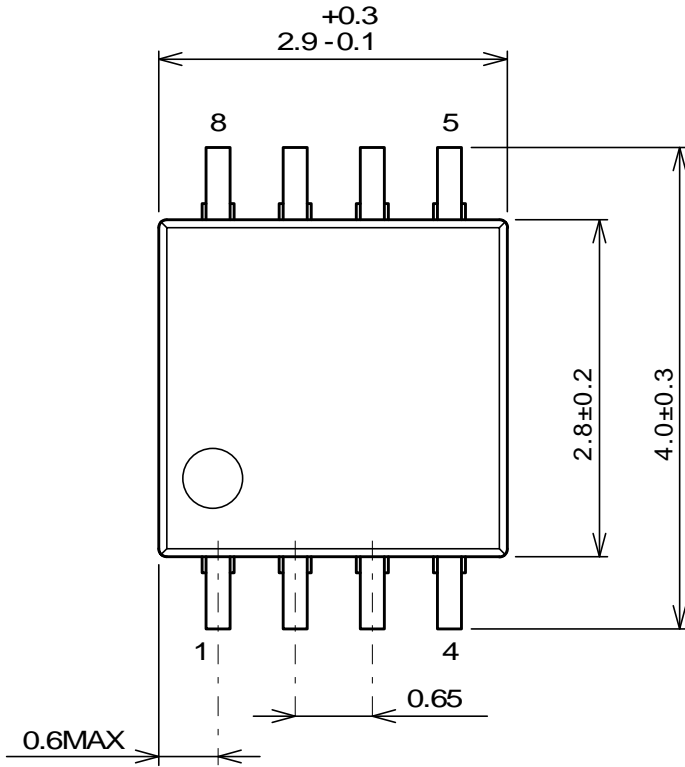

UNIT: mm

■PACKAGE DIMENSIONS

SOP8 JEDEC 150 mil

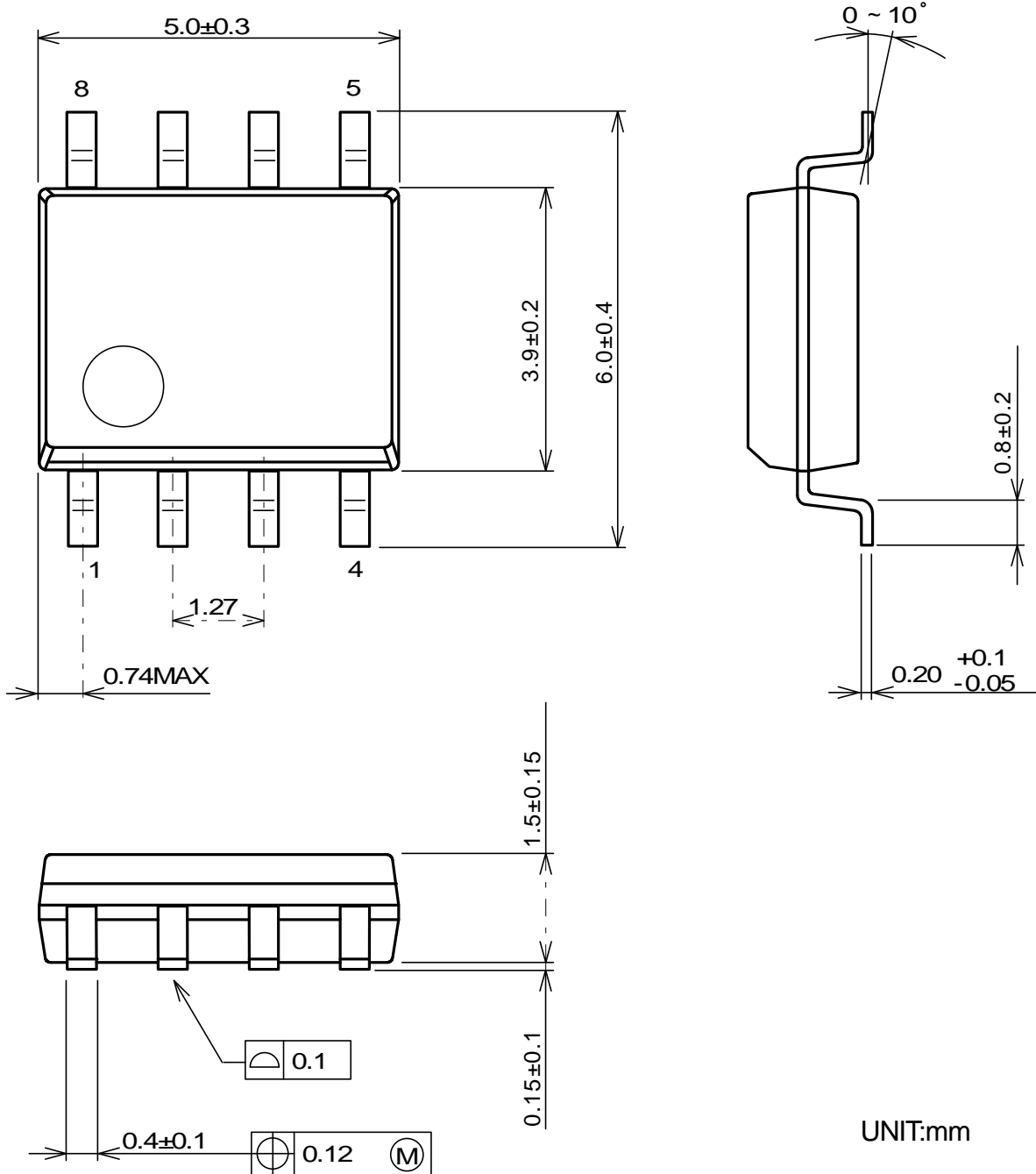

NJM8512/NJM8513

PACKAGE DIMENSIONS

SSOP14

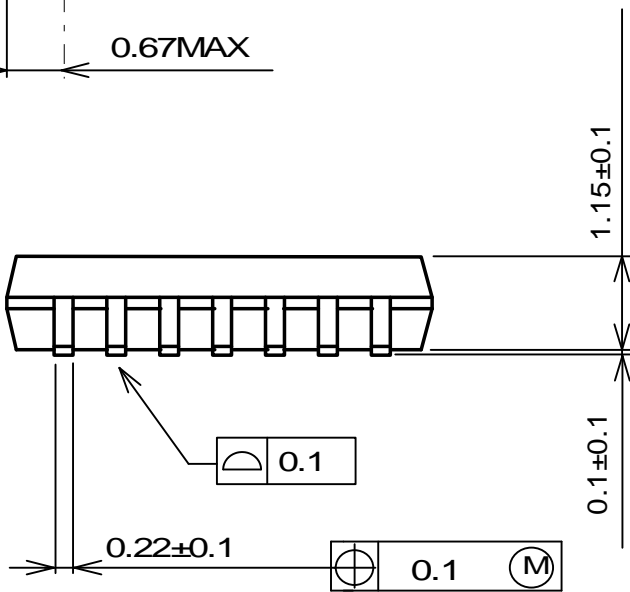
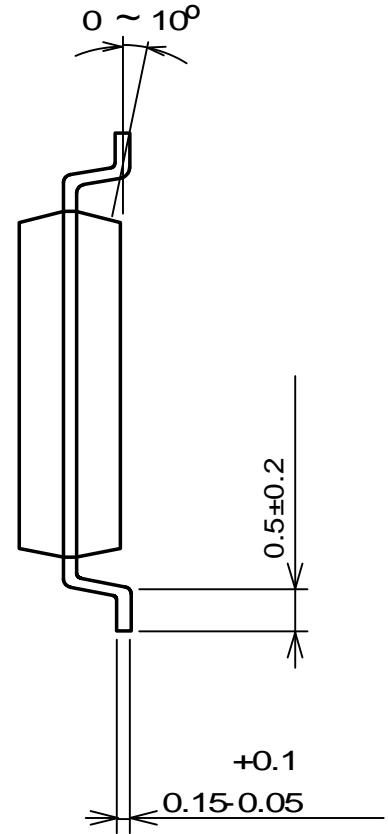
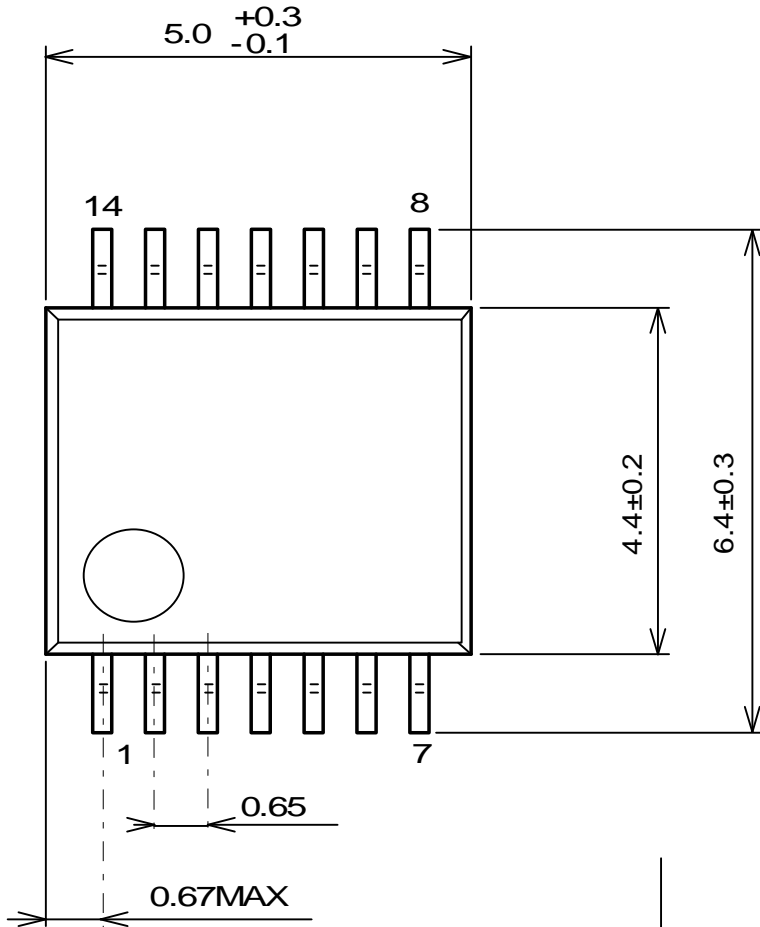

UNIT:mm

[CAUTION]
 The specifications on this data book are only given for information, without any guarantee as regards either mistakes or omissions. The application circuits in this data book are described only to show representative usages of the product and not intended for the guarantee or permission of any right including the industrial rights.