

High Frequency-Stability Fundamental Quartz Crystal Oscillator IC

■GENERAL DESCRIPTION

The NJU6364 series is a C-MOS IC for fundamental quartz crystal oscillator that consists of an oscillation amplifier, 5-stage divider and 3-state output buffer.

The operating voltage is from 2.0V to 3.6V and high frequency-stability based on most suitable oscillation circuit including Cg, Cd and Rf.

The 5-stage divider generates only one frequency selected of $f_0, f_0/2, f_0/4, f_0/8, f_0/16$ and $f_0/32$ by internal circuits is output.

The oscillation amplifier is realized very low stand-by current using NAND circuit.

The 3-state output buffer is C-MOS compatible.

■PACKAGE OUTLINE



NJU6364XC-X

■FEATURES

- High Frequency-Stability for Operating Voltage
- Operating Voltage 2.0 to 3.6V
- Maximum Oscillation Frequency 60MHz
- Low Operating Current
- 5-Stage Divider Maximum Divider $f_0/32$
- Oscillation Stop and Output Stand-by Function
- 3-State Output Buffer
- Oscillation Capacitors Cg and Cd on-Die
- Package Outline Thin-Die/Wafer
- C-MOS Technology

■PAD LOCATION

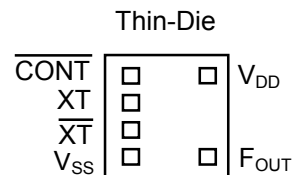

■LINE-UP TABLE

Type No.	F _{OUT}	Internal Connect	Cg/Cd	
NJU6364	A	f_0	Connected A Line	8/9pF
	B	$f_0/2$	Connected B Line	8/9pF
	C	$f_0/4$	Connected C Line	8/9pF
	D	$f_0/8$	Connected D Line	8/9pF
	E	$f_0/16$	Connected E Line	8/9pF
	F	$f_0/32$	Connected F Line	8/9pF

■COORDINATES

No	Pad Name	X	Y
1	CONT	-178	231
2	XT	-178	77
3	XT	-178	-77
4	V _{SS}	-178	-231
5	F _{OUT}	206	-231
8	V _{DD}	206	231

Starting Point: Chip Center Unit[μ m]
 Chip Size: 0.7x0.75mm
 Thin-Die Thickness(C-D): 200 \pm 20 μ m
 Thin-Die Thickness(C-L): 140 \pm 10 μ m
 Wafer Thickness(W-H): 200 \pm 20 μ m
 Wafer Thickness(W-L): 140 \pm 10 μ m
 Pad Size: 90x90 μ m
 Die Substrate: V_{DD} Level

■BLOCK DIAGRAM

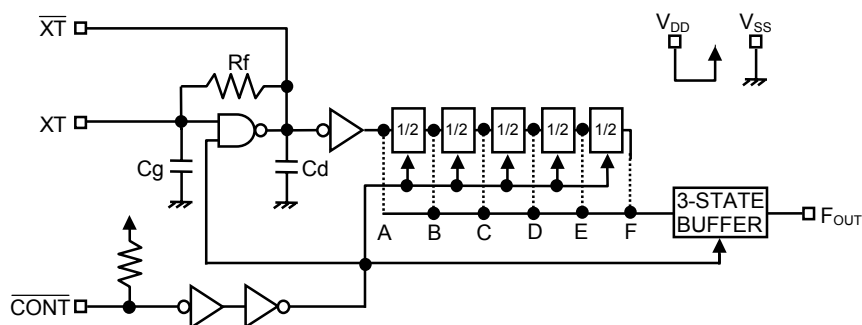

■ TERMINAL DESCRIPTION

SYMBOL	FUNCTION	
CONT	Oscillation and 3-state Output Buffer Control	
	CONT	F _{OUT}
	H or OPEN	Output either one frequency selected of f ₀ , f ₀ /2, f ₀ /4, f ₀ /8, f ₀ /16 and f ₀ /32 (Note1)
	L	Oscillation Stop and High impedance Output
XT	Quartz Crystal Connecting Terminals	
$\overline{\text{XT}}$		
V _{SS}	V _{SS} =0V	
F _{OUT}	Frequency Output	
V _{DD}	V _{DD} =2.5V/3.3V	

Note1) Refer to the line-up table.

■ ABSOLUTE MAXIMUM RATINGS

(Ta=25°C)

PARAMETER	SYMBOL	RATING	UNIT
Supply Voltage	V _{DD}	-0.5 to +7.0	V
Input Voltage	V _{IN}	V _{SS} -0.5 to V _{DD} +0.5	V
Output Voltage	V _O	-0.5 to V _{DD} +0.5	V
Input Current	I _{IN}	±10	mA
Output Current	I _O	±25	mA
Operating Temperature Range	Topr	-40 to +85	°C
Storage Temperature Range	Tstg	-55 to +125	°C

Note2) If the supply voltage(V_{DD}) is less than 7.0V, the input voltage must not over the V_{DD} level though 7.0V is limit specified.

Note3) Decoupling capacitor should be connected between V_{DD} and V_{SS} due to the stabilized operation for the circuit.

■ ELECTRICAL CHARACTERISTICS

(Ta=25°C)

PARAMETER	SYMBOL	CONDITIONS	MIN	TYP	MAX	UNIT
Operating Voltage	V _{DD}		2.0		3.6	V

(V_{DD}=2.5V, Ta=25°C)

PARAMETER	SYMBOL	CONDITIONS	MIN	TYP	MAX	UNIT
Operating Current	I _{DD}	A version, fosc=16MHz, C _L =15pF			2.5	mA
		B version, fosc=16MHz, C _L =15pF			2.0	
		C version, fosc=16MHz, C _L =15pF			1.5	
		D version, fosc=16MHz, C _L =15pF			1.5	
		E version, fosc=16MHz, C _L =15pF			1.5	
		F version, fosc=16MHz, C _L =15pF			1.5	
Oscillation Stopping Current	I _{STB}	CONT=V _{SS} , No load			1	uA
Stand-by Current	I _{st}	CONT=XT=V _{SS} , No load Note4)			1	uA
Input Voltage	V _{IH}		1.75		2.5	V
	V _{IL}		0		0.75	V
Output Current	I _{OH}	V _{OH} =2.25V	5			mA
	I _{OL}	V _{OL} =0.25V	5			mA
Input Current	I _{IN}	CONT=0.8V _{DD}		3.6	5.5	uA
		CONT=0.2V _{DD}		0.3	0.5	uA
3-state Off Leakage Current	I _{OZ}	CONT=V _{SS} , F _{OUT} = V _{DD} or V _{SS}			±0.1	uA
Feedback Resistance	R _f			255		kΩ
Internal Capacitor	C _g /C _d	fosc=16MHz		8/9		pF
Maximum Oscillation Frequency	F _{MAX}		60			MHz
Output Signal Symmetry	SYM	C _L =15pF, @V _{DD} /2	45	50	55	%
		C _L =30pF, @V _{DD} /2	40	50	60	
Output Signal Rise Time	tr	C _L =15pF, 10% to 90%		2.8	5.5	ns
		C _L =30pF, 10% to 90%		4.5	9	
Output Signal Fall Time	tf	C _L =15pF, 90% to 10%		2.8	5.5	ns
		C _L =30pF, 90% to 10%		4.5	9	
Output Disable time	t _{PLZ}	C _L =15pF, R _{UP} =10kΩ			200	ns
Output Enable Time	t _{PZL}	C _L =15pF, R _{UP} =10kΩ			200	ns

Note4) Excluding input current on CONT Terminal.

($V_{DD}=3.3V, T_a=25^{\circ}C$)

PARAMETER	SYMBOL	CONDITIONS	MIN	TYP	MAX	UNIT
Operating Current	I_{DD}	A version, $f_{osc}=16MHz, C_L=15pF$			3.5	mA
		B version, $f_{osc}=16MHz, C_L=15pF$			3.0	
		C version, $f_{osc}=16MHz, C_L=15pF$			2.5	
		D version, $f_{osc}=16MHz, C_L=15pF$			2.5	
		E version, $f_{osc}=16MHz, C_L=15pF$			2.5	
		F version, $f_{osc}=16MHz, C_L=15pF$			2.5	
Oscillation Stopping Current	I_{STB}	$\overline{CONT}=V_{SS}$, No load			1	μA
Stand-by Current	I_{st}	$\overline{CONT}=XT=V_{SS}$, No load Note4)			1	μA
Input Voltage	V_{IH}		2.31		3.3	V
	V_{IL}		0		0.99	V
Output Current	I_{OH}	$V_{OH}=2.97V$	6			mA
	I_{OL}	$V_{OL}=0.33V$	6			mA
Input Current	I_{IN}	$\overline{CONT}=0.8V_{DD}$		6.5	10	μA
		$\overline{CONT}=0.2V_{DD}$		0.5	1	μA
3-state Off Leakage Current	I_{OZ}	$\overline{CONT}=V_{SS}$, $F_{OUT}=V_{DD}$ or V_{SS}			± 0.1	μA
Feedback Resistance	R_f			255		k Ω
Internal Capacitor	C_g/C_d	$f_{osc}=16MHz$		8/9		pF
Maximum Oscillation Frequency	F_{MAX}		60			MHz
Output Signal Symmetry	SYM	$C_L=15pF, @V_{DD}/2$	45	50	55	%
		$C_L=30pF, @V_{DD}/2$	45	50	55	
Output Signal Rise Time	t_r	$C_L=15pF, 10\%$ to 90%		2.5	5	ns
		$C_L=30pF, 10\%$ to 90%		4	8	
Output Signal Fall Time	t_f	$C_L=15pF, 90\%$ to 10%		2.5	5	ns
		$C_L=30pF, 90\%$ to 10%		4	8	
Output Disable time	t_{PLZ}	$C_L=15pF, R_{UP}=10k\Omega$			150	ns
Output Enable Time	t_{PZL}	$C_L=15pF, R_{UP}=10k\Omega$			150	ns

Note4) Excluding input current on \overline{CONT} Terminal.

MEASUREMENT CIRCUITS

(1) Output Signal Symmetry ($C_L=15\text{pF}$)

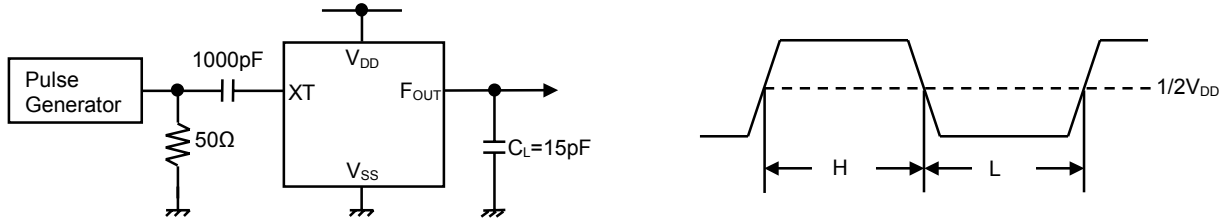

(2) Output Signal Rise/Fall Time ($C_L=15\text{pF}$)

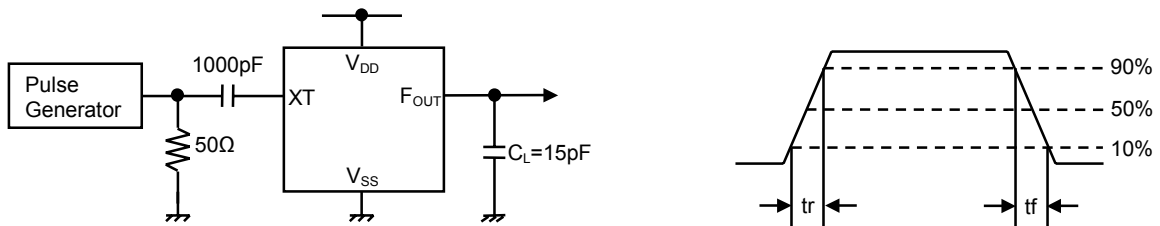

(3) Output Disable/Enable Time ($C_L=15\text{pF}, R_{UP}=10\text{k}\Omega$)

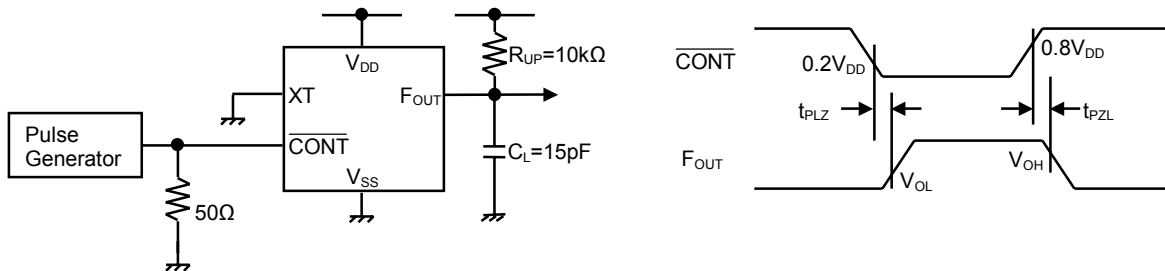

■ FREQUENCY STABILITY CHARACTERISTICS EXAMPLE

fcenter=16MHz, Vdd=2.5V±10%

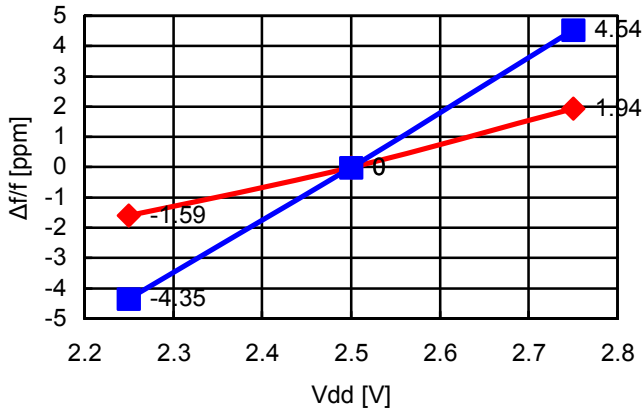

◆ NJU6364 ■ Previous

fcenter=16MHz, Vdd=3.3V±10%

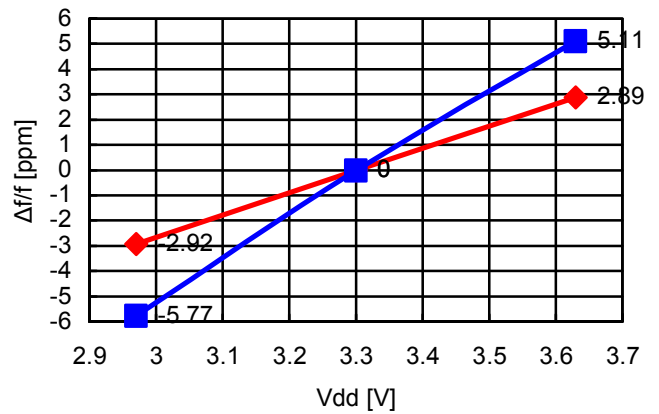

◆ NJU6364 ■ Previous

fcenter=20MHz, Vdd=2.5V±10%

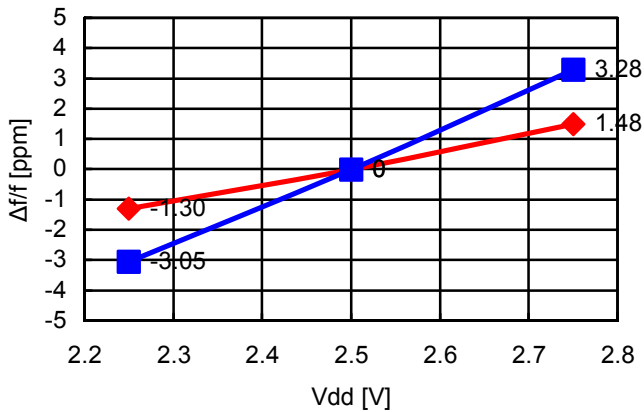

◆ NJU6364 ■ Previous

fcenter=20MHz, Vdd=3.3V±10%

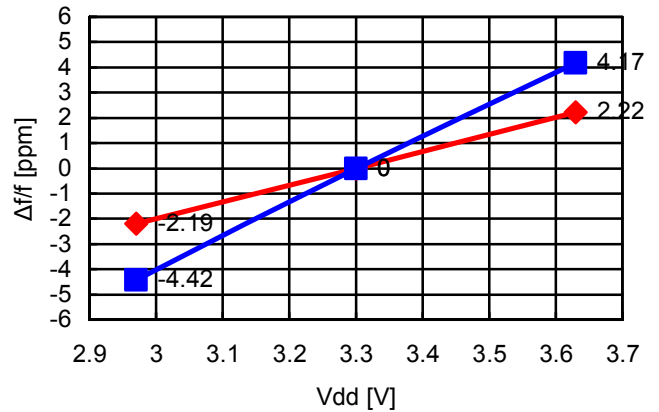

◆ NJU6364 ■ Previous

fcenter=32MHz, Vdd=2.5V±10%

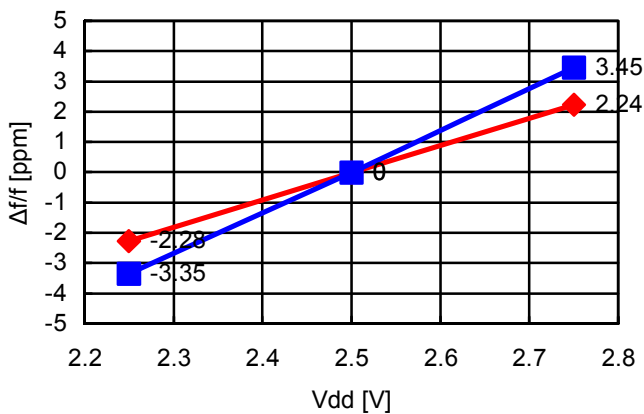

◆ NJU6364 ■ Previous

fcenter=32MHz, Vdd=3.3V±10%

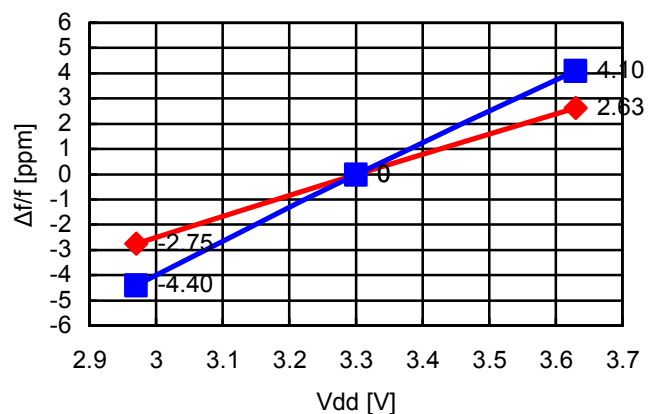

◆ NJU6364 ■ Previous



[CAUTION]

The specifications on this data book are only given for information, without any guarantee as regards either mistakes or omissions. The application circuits in this data book are described only to show representative usages of the product and not intended for the guarantee or permission of any right including the industrial rights.