

1/4 DUTY LCD DRIVER

■ GENERAL DESCRIPTION

The NJU6433 is a 1/4 duty LCD driver for segment type LCD panel.

The LCD driver consists of 4-common and 50-segment drives up to 200 segments.

The NJU6433 is useful for the digital tuning system or others segment type display driver.

■ PACKAGE OUTLINE

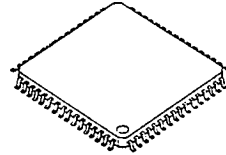

NJU6433F

■ FEATURES

- 50 Segment Drivers
- Duty Ratio 1/4 (Up to 200-Segments)
- Serial Data Transmission (Shift Clock 2MHz max.)
- Oscillation Circuit On-chip (External Resistance Required)
- Display Off Function (INH Terminal)
- Operating Voltage --- 2.4~5.5V
- LCD Driving Voltage --- 6.5V Max.
- Package Outline --- QFP 64 (D1, G1)
- C-MOS Technology

■ BLOCK DIAGRAM

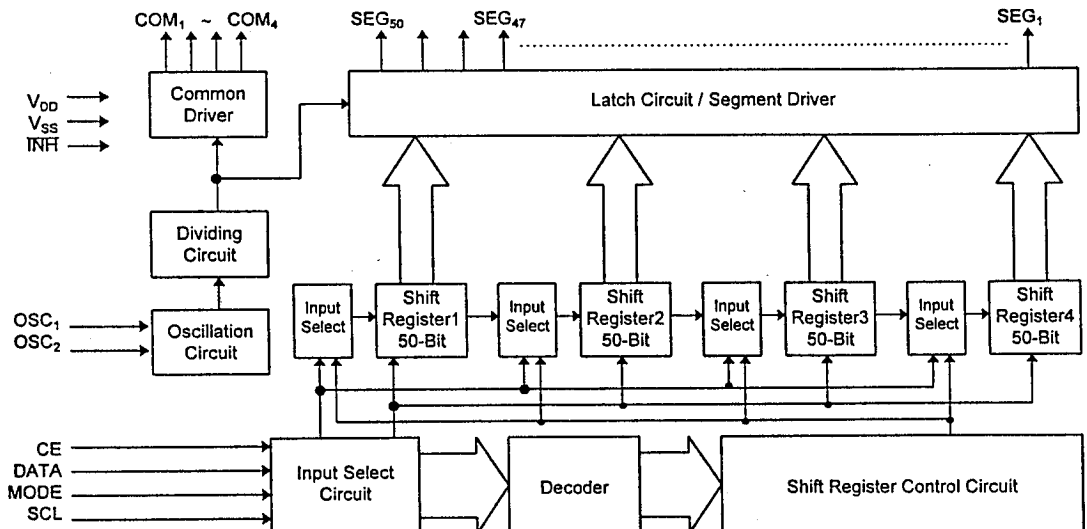

■ PIN CONFIGURATION

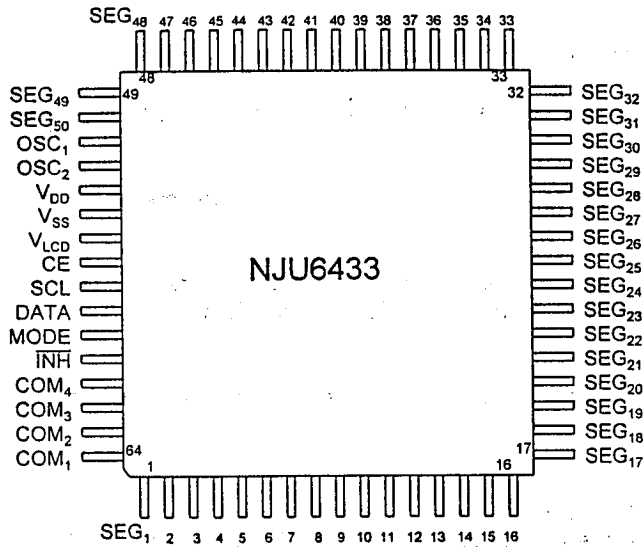

■ TERMINAL DESCRIPTION

NO.	SYMBOL	F U N C T I O N
1~50	SEG ₁ ~ SEG ₅₀	LCD Segment Output Terminals
51	OSC ₁	Oscillation Terminals : External resistance is connected to these terminals.
52	OSC ₂	
53	V _{DD}	Power Supply (+5V)
54	V _{SS}	Power Supply (0V)
55	V _{LCD}	Power Supply for LCD Driving The relation : $V_{DD} - V_{LCD} \leq 1.3V_{DD}$, $V_{LCD} \geq V_{SS}$ must be maintained.
56	CE	Chip Enable Signal Input Terminal : "H" : LCD display data and mode setting data input "L" : Disable Fall Edge : LCD display data latch
57	SCL	Serial Data Transmission Clock Input Terminal : LCD display and Mode setting data are input synchronized SCL clock signal rise edge.
58	DATA	Serial Data Input Terminal Data input timing : SCL clock rise edge
59	MODE	Data or Mode Select Terminal "H" : Data input mode "L" : LCD display data input mode (refer the mode setting table for mode setting contents)
60	INH	Display-Off Control Terminal : When display goes to off, the display data in the shift-register is retained. "H" : Display-On "L" : Display-Off
61~64	COM ₄ ~COM ₁	LCD Common Output Terminals

FUNCTIONAL DESCRIPTION

(1) Operation of each block

(1-1) Oscillation Circuit :

The oscillation circuit operate by connecting external resistance (capacitance is incorporated).

This circuit provides the clock signal to both common and segment drivers.

(1-2) Divider Circuit

This circuit divides the oscillating signal to generate the common and segment timing.

(1-3) Shift-Register

When the CE terminal is "H" (Enable mode), the display data is transferred to the shift-register synchronized by the shift clock on the SCL terminal.

(1-4) Latch Circuit and Segment Driver

When the CE signal falling, the display data is latched, and the data controls the segment signal of display-on/off.

(2) Data Input Format

(2-1) Input Data Correspond to Segment Status

The "H" input data correspond to segment "ON" and "L" correspond to "OFF".

Data Dxxx	Segment Status
"H"	ON
"L"	OFF

(2-2) Write to Shift-register

Write to shift-register performs Mode setting data writing and LCD display data writing.

Example 1 (Mode 1): Write to Shift-register 1 (1 to 50-bit)

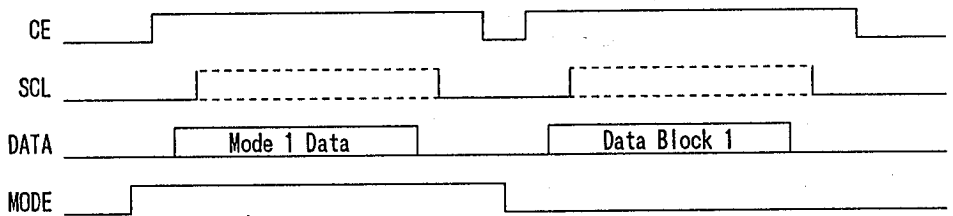

Example 2 (Mode 2): Write to Shift-register 2 (51 to 100-bit)

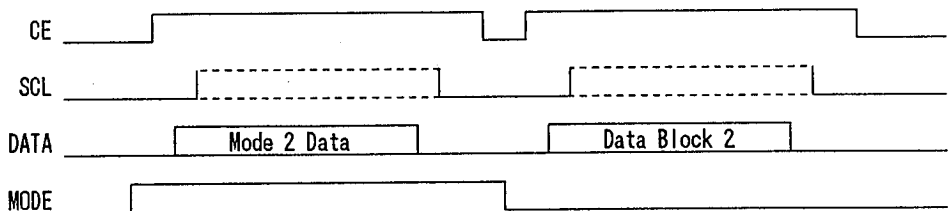

Example 3(Mode 3): Write to Shift-register 3(101 to 150-bit)

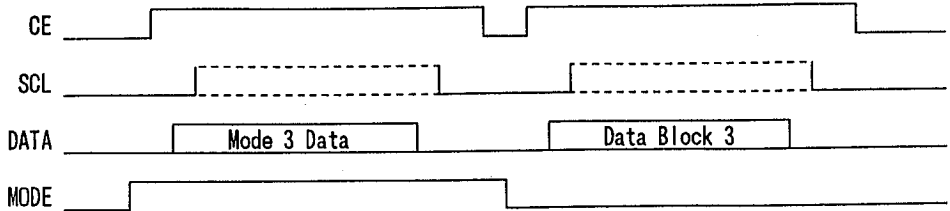

Example 4(Mode 4): Write to Shift-register 4(151 to 200-bit)

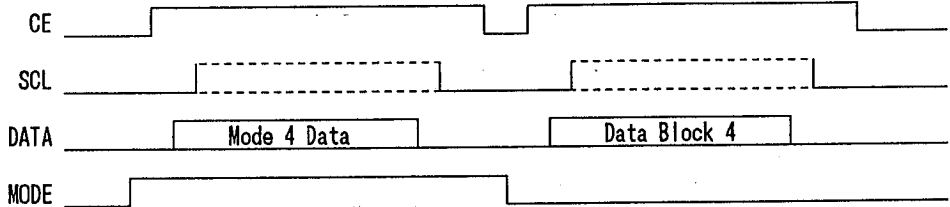

Example 5(Mode 5): Write to Shift-register 5(1 to 200-bit)

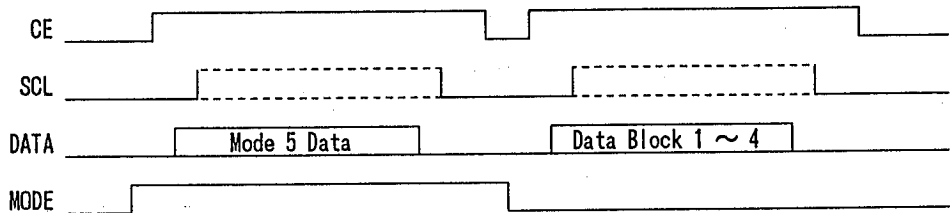
(2-3) Mode Setting

Transferd register selection and all clear of the shift register are performed by writing 4-bit code shown below to the decoder in CE = "H" and MODE = "H" state.

< Input Timing Chart >

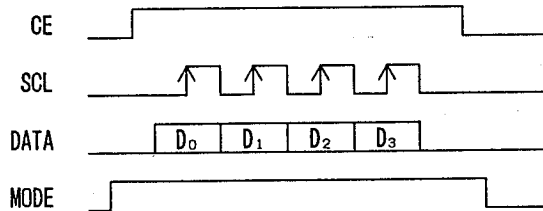

< Mode Setting Table >

CE Terminal	MODE Terminal	DATA Terminal D ₃ D ₂ D ₁ D ₀	MODE # Data (HEX)	Mode Set Up
"H"	"H"	0 0 0 1	(01 _H)	Select the shift-register 1
		0 0 1 0	(02 _H)	Select the shift-register 2
		0 0 1 1	(03 _H)	Select the shift-register 3
		0 1 0 0	(04 _H)	Select the shift-register 4
		0 1 0 1	(05 _H)	Select the all shift-register (1 to 4)
		1 1 1 1	(0F _H)	All shift-register is "L"

Note) The internal decoder is data through type. Therefore, the 8 bits data also can write though only 4 bits data from the CE falling are validated.

(2-4)Block Data and Whole Data transfer

a.Block Data(50-bit) transfer

In this mode, each 50 bits data block send to the each register.

Data Block 1 : from SEG₁ of COM₁ to SEG₁₃ of COM₂

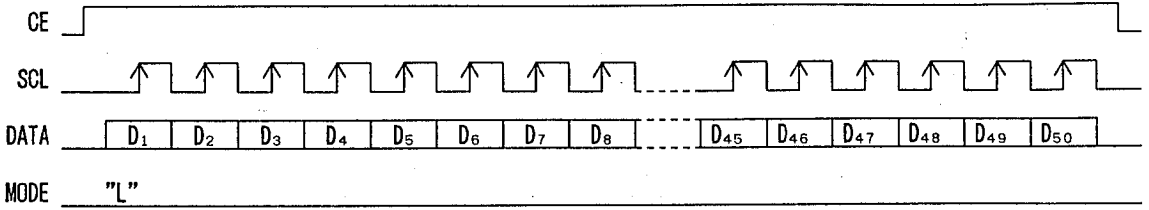

Data Block 2 : from SEG₁₃ of COM₃ to SEG₂₅ of COM₄

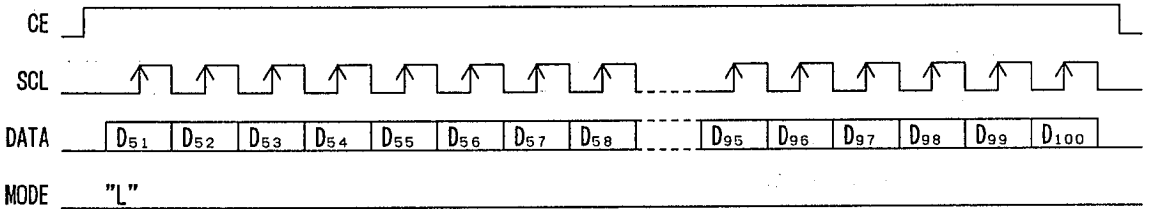

Data Block 3 : from SEG₂₆ of COM₁ to SEG₃₈ of COM₂

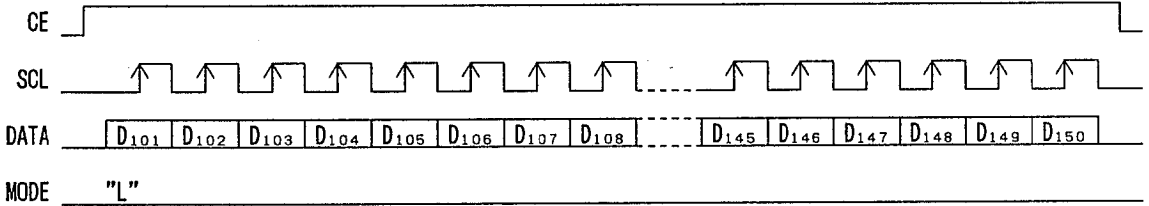

Data Block 4 : from SEG₃₈ of COM₃ to SEG₅₀ of COM₄

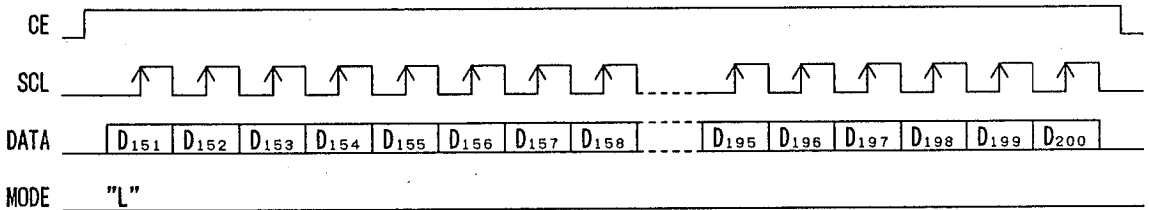

b.Whole Data(200-bit) transfer

from shift-register 1 to shift-register 4

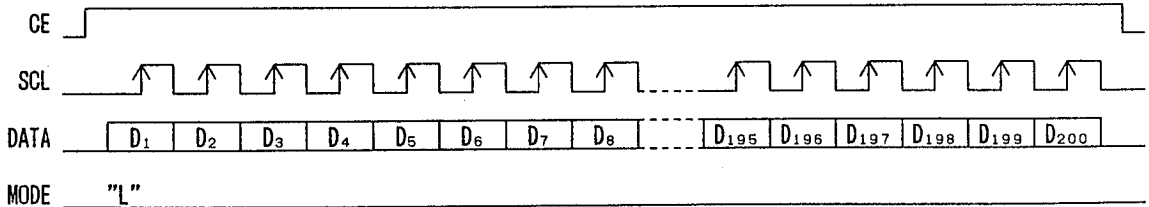

5

(2-5) Display Data Correspond to Segment and Common Terminals

Mode	Data	Segment	COM ₁	COM ₂	COM ₃	COM ₄	Data Block
Mode 1	D ₁ D ₂ D ₃ D ₄	SEG ₁	○	○	○	○	Data Block 1
	D ₅ D ₆ D ₇ D ₈	SEG ₂	○	○	○	○	
	⋮	⋮	⋮	⋮	⋮	⋮	
	D ₄₅ D ₄₆ D ₄₇ D ₄₈	SEG ₁₂	○	○	○	○	
	D ₄₉ D ₅₀	SEG ₁₃	○	○			
Mode 2	D ₅₁ D ₅₂	SEG ₁₃			○	○	Data Block 2
	D ₅₃ D ₅₄ D ₅₅ D ₅₆	SEG ₁₄	○	○	○	○	
	⋮	⋮	⋮	⋮	⋮	⋮	
	D ₉₇ D ₉₈ D ₉₉ D ₁₀₀	SEG ₂₅	○	○	○	○	
Mode 3	D ₁₀₁ D ₁₀₂ D ₁₀₃ D ₁₀₄	SEG ₂₆	○	○	○	○	Data Block 3
	D ₁₀₅ D ₁₀₆ D ₁₀₇ D ₁₀₈	SEG ₂₇	○	○	○	○	
	⋮	⋮	⋮	⋮	⋮	⋮	
	D ₁₄₅ D ₁₄₆ D ₁₄₇ D ₁₄₈	SEG ₃₇	○	○	○	○	
	D ₁₄₉ D ₁₅₀	SEG ₃₈	○	○			
Mode 4	D ₁₅₁ D ₁₅₂	SEG ₃₈			○	○	Data Block 4
	D ₁₅₃ D ₁₅₄ D ₁₅₅ D ₁₅₆	SEG ₃₉	○	○	○	○	
	⋮	⋮	⋮	⋮	⋮	⋮	
	D ₁₉₇ D ₁₉₈ D ₁₉₉ D ₂₀₀	SEG ₅₀	○	○	○	○	

■ ABSOLUTE MAXIMUM RATINGS

PARAMETER	SYMBOL	RATINGS	UNIT
Operating Voltage (1)	V_{DD}	- 0.3 ~ + 7.0	V
Operating Voltage (2) Note 1)	V_{LCD}	$V_{DD} - 6.5 \sim V_{SS}$	V
Input Voltage (1) Note 2)	$V_{i(1)}$	- 0.3 ~ + 7.0	V
Input Voltage (2) Note 3)	$V_{i(2)}$	- 0.3 ~ $V_{DD}+0.3$	V
Output Voltage Note 3)	V_o	- 0.3 ~ $V_{DD}+0.3$	V
Output Current (1) Note 4)	$I_{o(1)}$	100	μA
Output Current (2) Note 5)	$I_{o(2)}$	1.0	mA
Power Dissipation	P_d	300	mW
Operating Temperature	T_{opr}	- 30 ~ + 85	$^{\circ}C$
Storage Temperature	T_{stg}	- 40 ~ + 125	$^{\circ}C$

 Note 1) $|V_{DD} - V_{LCD}| \leq 1.3V_{DD}$, $V_{LCD} \leq V_{SS}$

Note 2) CE, SCL, DATA, MODE, TNH Terminals

 Note 3) OSC₁, OSC₂ Terminals

 Note 4) SEG₁ ~ SEG₅₀ Terminals

 Note 5) COM₁ ~ COM₄ Terminals

■ ELECTRICAL CHARACTERISTICS

• DC Characteristics

 ($T_a=25^{\circ}C$, $V_{DD}=5.0V$, $V_{SS}=0V$, $V_{LCD}=V_{DD}-6.5V$)

PARAMETER	SYMBOL	CONDITIONS	MIN	TYP	MAX	UNIT
Operating Voltage (1)	V_{DD}	V_{DD} Terminal	2.4		5.5	V
Operating Voltage (2)	V_{LCD}	V_{LCD} Terminal Note 6)	V_{SS}		$V_{DD}-6.5$	V
"H" Input Voltage	V_{IH}	CE, SCL, DATA, MODE,	0.7 V_{DD}		V_{DD}	V
"L" Input Voltage	V_{IL}	TNH Terminals	V_{SS}		0.3 V_{DD}	V
"H" Input Current	I_{IH}	CE, SCL, DATA, MODE, $V_i=V_{DD}$			5.0	μA
"L" Input Current	I_{IL}	TNH Terminals $V_i=V_{SS}$			5.0	μA
"H" Output Voltage (1)	$V_{OH(1)}$	SEG ₁ ~SEG ₅₀ $I_o=-10\mu A$	$V_{DD}-1.0$			V
"L" Output Voltage (1)	$V_{OL(1)}$	$I_o=+10\mu A$			$V_{LCD}+1.0$	V
Middle Level Voltage 1/3 (1)	$V_{MS1/3}$	SEG ₁ ~SEG ₅₀ $I_o=\pm 10\mu A$	$V_1-1.0$	V_1	$V_1+1.0$	V
Middle Level Voltage 2/3 (1)	$V_{MS2/3}$	Note 7) $I_o=\pm 10\mu A$	$V_2-1.0$	V_2	$V_2+1.0$	V
"H" Output Voltage (2)	$V_{OH(2)}$	COM ₁ ~COM ₄ $I_o=-100\mu A$	$V_{DD}-0.6$			V
"L" Output Voltage (2)	$V_{OL(2)}$	$I_o=+100\mu A$			$V_{LCD}-0.6$	V
Middle Level Voltage 1/3 (2)	$V_{MC1/3}$	COM ₁ ~COM ₄ $I_o=\pm 100\mu A$	$V_1-0.6$	V_1	$V_1+0.6$	V
Middle Level Voltage 2/3 (2)	$V_{MC2/3}$	Note 7) $I_o=\pm 100\mu A$	$V_2-0.6$	V_2	$V_2+0.6$	V
Oscillating Frequency Range	f_{osc}	OSC ₁ , OSC ₂ Terminals	25		200	kHz
Oscillating Frequency	f_{osc}	R=140k Ω	115	130	145	kHz
Operating Current (1)	I_{DD}	V_{DD} Terminal		50	80	μA
Operating Current (2)	I_{LCD}	V_{LCD} Terminal		15		μA
Hysteresis Voltage	V_H	CE, SCL, DATA, MODE, TNH Terminals	0.3			V

5

Note 6) The relation: $|V_{DD} - V_{LCD}| \leq 1.3V_{DD}$, $V_{LCD} \leq V_{SS}$ must be maintained.

Note 7) $V_1 = 1/3 |V_{DD} - V_{LCD}|$, $V_2 = 2/3 |V_{DD} - V_{LCD}|$

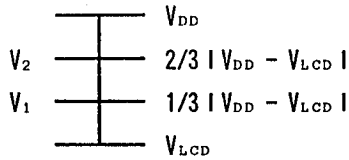

• AC Characteristics

($T_a=25^\circ\text{C}$, $V_{DD}=5.0\text{V}$, $V_{SS}=0\text{V}$, $V_{LCD}=V_{DD}-6.5\text{V}$)

PARAMETER	SYMBOL	CONDITIONS	MIN	TYP	MAX	UNIT
"L" Clock Pulse Width	t_{WCLL}	SCL Terminal	0.25			μs
"H" Clock Pulse Width	t_{WCLH}		0.25			μs
Data Set-up Time	t_{DS}	SCL, DATA Terminals	0.25			μs
Data Hold Time	t_{DH}		0.25			μs
CE Set-up Time	t_{SCE}	CE, DATA Terminals	1.0			μs
CE Hold Time (1)	t_{HDCE}		1.0			μs
CE Hold Time (2)	t_{HCLE}	CE, SCL Terminals	1.25			μs
Mode Set-up Time	t_{SMD}	CE, MODE Terminals	0.25			μs
Mode Hold Time	t_{HMD}		0.25			μs
"L" Chip Enable Pulse Width	t_{WCEL}	CE Terminal	4.0			μs

• Input Timing Characteristics

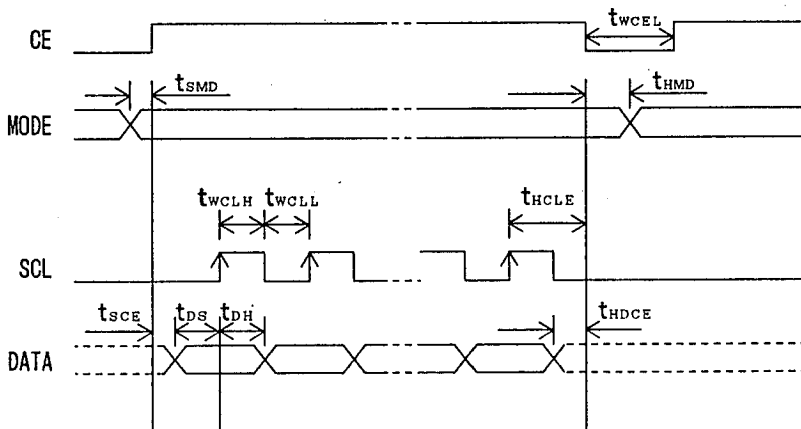

■ LCD Driving Waveform(1/4DUTY · 1/3BIAS)

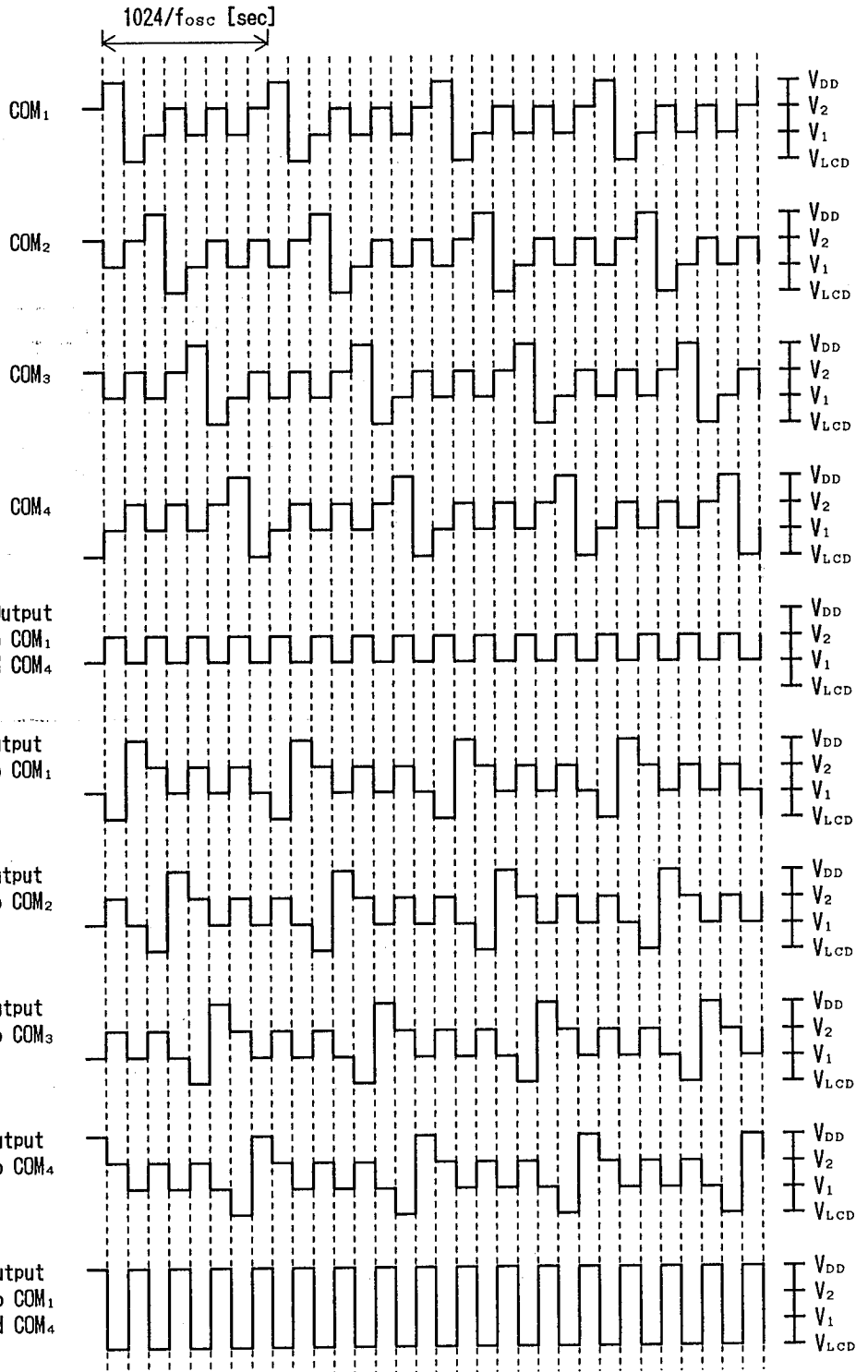

5

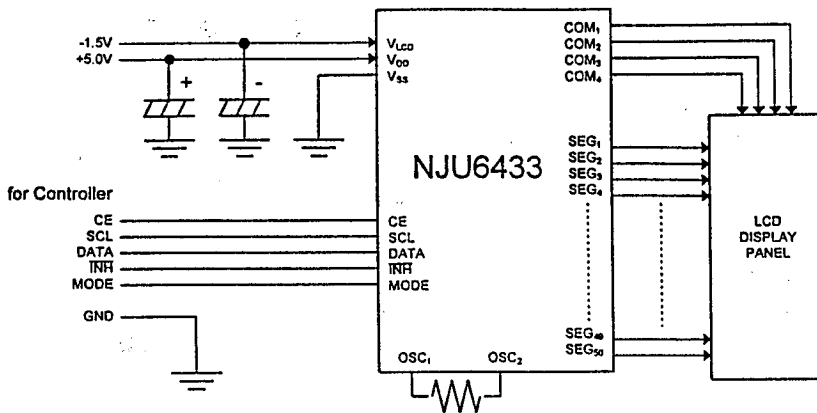
APPLICATION CIRCUIT

(Note) The internal display data is undefined when V_{DD} is just turned on.

To avoid the meaningless display, please keep the \overline{TNH} terminal at "L" until proper display data has been transferred.

In order to set the initial condition, 200-bit blank data or the first 200-bit data to be displayed should be transferred.

MEMO

[CAUTION]

The specifications on this databook are only given for information, without any guarantee as regards either mistakes or omissions. The application circuits in this databook are described only to show representative usages of the product and not intended for the guarantee or permission of any right including the industrial rights.