

LOW INPUT OFFSET VOLTAGE C-MOS OPERATIONAL AMPLIFIER

■ GENERAL DESCRIPTION

The NJU7051, 52 and 54 are single, dual and quad C-MOS Operational Amplifiers operated on a single-power-supply, low voltage and low operating current.

The input offset voltage is lower than 2mV, and the input bias current is as low as less than 1pA, consequently the very small signal around the ground level can be amplified.

The minimum operating voltage is 1V and the output stage permits output signal to swing between both of the supply rails.

Furthermore, the operating current is also as low as 15 μA (typ) per circuit, therefore it can be applied especially to battery operated items.

■ FEATURES

- Single-Power-Supply
- Low Input Offset Voltage ($V_{io} \approx 2mV_{max}$)
- Wide Operating Voltage ($V_{DD} = 1 \sim 16V$)
- Wide Output Swing Range ($V_{OM} = 2.94V$ typ. at $V_{DD} = 3V$)
- Low Operating Current (15 μA/circuit)
- Low Bias Current ($I_{IB} = 1pA$)
- Internal Compensation Capacitor
- External Offset Null Adjustment (Only NJU7051)
- Package Outline
 DIP/DMP/SSOP 8 (NJU7051)
 DIP/DMP 8 (NJU7052)
 DIP/DMP/SSOP 14 (NJU7054)
- C-MOS Technology

■ PACKAGE OUTLINE

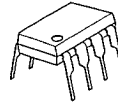

NJU7051D
NJU7052D



NJU7051M
NJU7052M

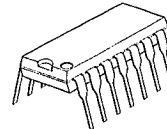

NJU7054D

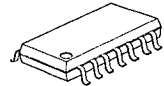

NJU7054M



NJU7051V



NJU7054V

■ PIN CONFIGURATION

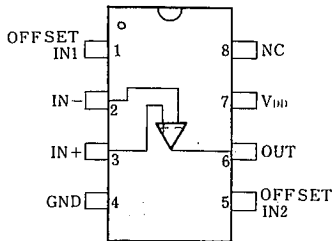

NJU7051D
NJU7051M
NJU7051V

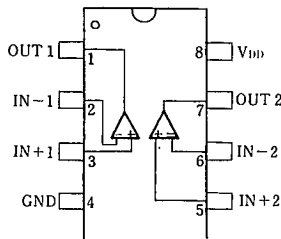

NJU7052D
NJU7052M

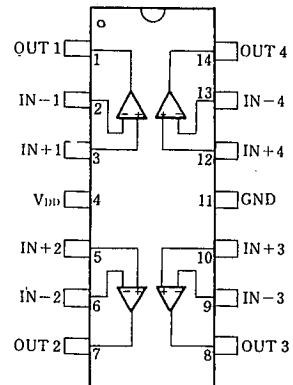

NJU7054D
NJU7054M
NJU7054V

■ EQUIVALENT CIRCUIT

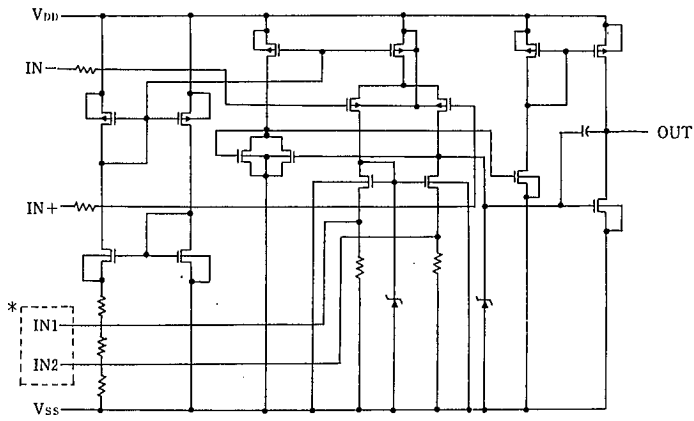

* IN1, IN2 are only for NJU7051(NJU7052/54 don't have these terminals).

4

■ ABSOLUTE MAXIMUM RATINGS

(Ta=25°C)

PARAMETER	SYMBOL	RATINGS	UNIT
Supply Voltage	V _{DD}	18	V
Differential Input Voltage	V _{ID}	±18 * 1	V
Common Mode Input Voltage	V _{IC}	-0.3~18	V
Power Dissipation	P _D	(DIP14) 700 (DIP8) 500 (DMP8,14) 300 (SSOP8,14) 300	mW
Operating Temperature	T _{opr}	-20~+75	°C
Storage Temperature	T _{stg}	-40~+125	°C

* 1) If the supply voltage (V_{DD}) is less than 18V, the input voltage must not over the V_{DD} level though 18V is limit specified.

■ ELECTRICAL CHARACTERISTICS

(Ta=25°C, V_{DD}=10V, R_L=∞)

PARAMETER	SYMBOL	CONDITIONS	MIN.	TYP.	MAX.	UNIT
Input Offset Voltage	V _{IO}	R _S =50Ω			2	mV
Input Offset Current	I _{IO}			1		pA
Input Bias Current	I _{IB}			1		pA
Input Impedance	R _{IN}			1		TΩ
Large Signal Voltage Gain	A _v		80	90		dB
Input Common Mode Voltage Range	V _{ICM}		0~2			V
Maximum Output Swing Voltage	V _{OM}	R _L =1MΩ	2.90	2.94		V
Common Mode Rejection Ratio	CMR		60	70		dB
Supply Voltage Rejection Ratio	SVR		60	70		dB
Operating Current / Circuit	I _{DD}			15	25	μA
Slew Rate	SR			0.05		V/μs
Unity Gain Bandwidth	F ₁	A _v =40dB C _L =10pF		0.1		MHz

■ OFFSET ADJUSTMENT CIRCUIT (ONLY FOR NJU7051)

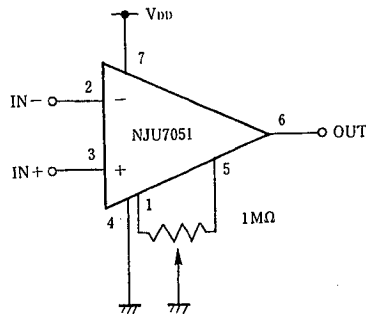

MEMO

[CAUTION]

The specifications on this databook are only given for information, without any guarantee as regards either mistakes or omissions. The application circuits in this databook are described only to show representative usages of the product and not intended for the guarantee or permission of any right including the industrial rights.