

Precision, Low Noise, Rail-to-Rail Output, CMOS Operational Amplifier

■ GENERAL DESCRIPTION

The NJU7076/NJU7077/NJU7078 is a high precision Rail-to-Rail output Single/Dual/Quad CMOS operational amplifier featuring a low noise of 10nV/ $\sqrt{\text{Hz}}$ typ., low input offset voltage of 150 μV max., low temperature drift of 0.5 $\mu\text{V}/^\circ\text{C}$ typ. and low bias current of 1pA typ..

The output swing can reach 20 mV from the rails, while driving a 10k Ω load (at 5V operation). The NJU7076/NJU7077/NJU7078 also has a high RF noise immunity which can reduce malfunctions caused by RF noises from mobile phones and others. The combination of these specifications makes the NJU7076/ NJU7077/NJU7078 well-suited for sensor applications such as a temperature sensor, weight sensor and others, high precision current sensing amplifiers and current voltage converters.

■ PACKAGE OUTLINE



NJU7076F
(SOT-23-5)



NJU7077R
(MSOP8(VSP8))

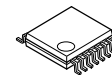

NJU7078V
(SSOP14)

■ FEATURES

- High Precision
 - Low Offset Voltage

NJU7076/NJU7077	150 μV max.
NJU7078	200 μV max.
 - Low Offset Voltage Drift

	0.5 $\mu\text{V}/^\circ\text{C}$ typ.
--	---------------------------------------
- Low Noise

	10nV/ $\sqrt{\text{Hz}}$ typ.
--	-------------------------------
- Low Input Bias Current

	1pA typ.
--	----------
- Rail-to-Rail Output

$R_L=10\text{k}\Omega$	0.02V to 4.98V typ. ($V^+=5\text{V}$)
$R_L=600\Omega$	0.08V to 4.92V typ. ($V^+=5\text{V}$)
- Ground sense
- RF Noise Immunity
- Operating Voltage

	2.2V to 5.5V
--	--------------
- Unity-Gain Stable
- Package

NJU7076	SOT-23-5
NJU7077	MSOP8(VSP8)*
	*MEET JEDEC MO-187-DA
NJU7078	SSOP14

■ APPLICATIONS

- Thermocouple / Thermopile Amplifiers
- Strain Gauge / Pressure sensor Amplifiers
- Load Cell and Bridge Transducer Amplifiers
- High Resolution Data Acquisition
- Precision Current Sensing
- Battery monitoring
- Photo-Diode pre amplifier

■ PIN CONFIGURATION

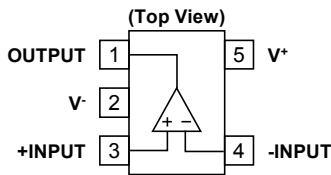

NJU7076F

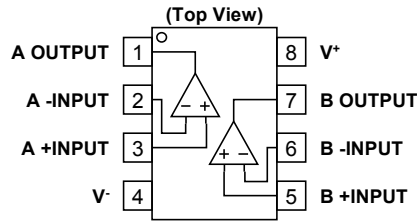

NJU7077R

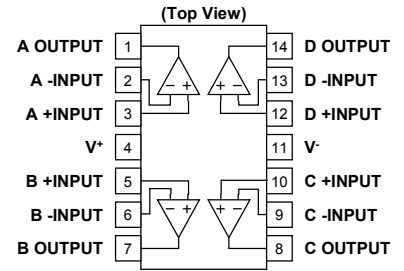

NJU7078V

■ ABSOLUTE MAXIMUM RATINGS(Ta=25°C, unless otherwise noted.)

PARAMETER	SYMBOL	RATING	UNIT
Supply Voltage	$V^+ - V^-$	7 ⁽¹⁾	V
Differential Input Voltage ⁽²⁾	V_{ID}	± 7 ⁽³⁾	V
Input Voltage	V_{IN}	$V^- - 0.3$ to $V^+ + 0.3$	V
Power Dissipation ⁽⁴⁾		(2-layer / 4-layer)	mW
SOT-23-5	P_D	480 / 650	mW
MSOP8(VSP8)		500 / 660	mW
SSOP14		555 / 690	mW
Operating Temperature Range	T_{opr}	-40 to +125	°C
Storage Temperature Range	T_{stg}	-55 to +150	°C

(1) Supply Voltage is the voltage difference between V^+ and V^- .

(2) Differential voltage is the voltage difference between +INPUT and -INPUT.

(3) For supply voltage less than 7V, the absolute maximum rating is equal to the supply voltage.

(4) Power dissipation is the power that can be consumed by the IC at $T_a=25^\circ\text{C}$, and is the typical measured value based on JEDEC condition. When using the IC over $T_a=25^\circ\text{C}$ subtract the value $[\text{mW}/^\circ\text{C}] = P_D / (T_{stg}(\text{MAX}) - 25)$ per temperature.

2-layer: EIA/JEDEC STANDARD Test board (76.2x114.3x1.6mm, 2layers, FR-4) mounting

4-layer: EIA/JEDEC STANDARD Test board (76.2x114.3x1.6mm, 4layers, FR-4) mounting

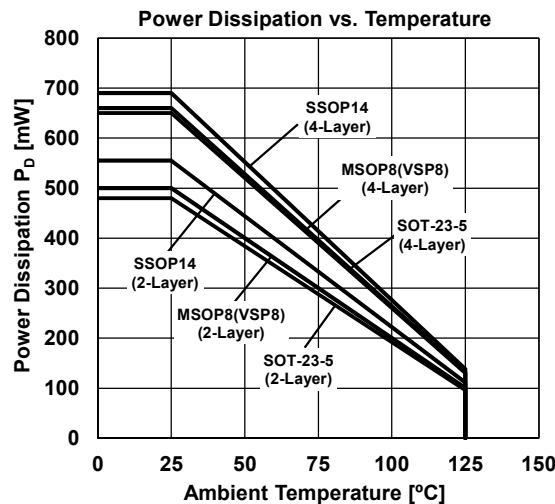

■ RECOMMENDED OPERATING CONDITIONS(Ta=25°C)

PARAMETER	Value	UNIT
Supply Voltage	+2.2 to +5.5 (± 1.1 to ± 2.75)	V

■ **ELECTRICAL CHARACTERISTICS** ($V^+=5V$, $V^-=0V$, $V_{COM}=V^+/2$, $T_a=25^\circ C$, unless otherwise noted.)

PARAMETER	SYMBOL	TEST CONDITION	MIN.	TYP.	MAX.	UNIT
DC CHARACTERISTICS						
Input Offset Voltage NJU7076/NJU7077 NJU7078	V_{IO}	$T_a=-40^\circ C$ to $125^\circ C$	-	20	150	μV
			-	-	400	μV
		$T_a=-40^\circ C$ to $125^\circ C$	-	20	200	μV
			-	-	400	μV
Input Offset Voltage Drift	$\Delta V_{IO}/\Delta T$	$T_a=-40^\circ C$ to $125^\circ C$ ⁽⁵⁾	-	0.5	5	$\mu V/^\circ C$
Input Bias Current	I_B		-	1	-	pA
Input Offset Current	I_{IO}		-	1	-	pA
Open-Loop Voltage Gain	A_V	$V_O=0.5V$ to $4.5V$, $R_L=10k\Omega$ to $2.5V$	100	130	-	dB
		$V_O=0.5V$ to $4.5V$, $R_L=10k\Omega$ to $2.5V$, $T_a=-40^\circ C$ to $125^\circ C$	100	-	-	dB
Common-Mode Rejection Ratio	CMR	$V_{ICM}=0V$ to $4V$	70	90	-	dB
		$V_{ICM}=0V$ to $4V$, $T_a=-40^\circ C$ to $125^\circ C$	70	-	-	dB
Supply Voltage Rejection Ratio	SVR	$V^+=2.2V$ to $5.5V$	70	90	-	dB
		$V^+=2.2V$ to $5.5V$, $T_a=-40^\circ C$ to $125^\circ C$	70	-	-	dB
High-level Output Voltage	V_{OH}	$R_L=10k\Omega$ to $2.5V$	4.95	4.98	-	V
		$R_L=10k\Omega$ to $2.5V$, $T_a=-40^\circ C$ to $125^\circ C$	4.95	-	-	V
		$R_L=600\Omega$ to $2.5V$	4.85	4.92	-	V
		$R_L=600\Omega$ to $2.5V$, $T_a=-40^\circ C$ to $125^\circ C$	4.85	-	-	V
		$I_{SOURCE}=2mA$	4.9	4.96	-	V
		$I_{SOURCE}=2mA$, $T_a=-40^\circ C$ to $125^\circ C$	4.85	-	-	V
Low-level Output Voltage	V_{OL}	$R_L=10k\Omega$ to $2.5V$	-	0.02	0.05	V
		$R_L=10k\Omega$ to $2.5V$, $T_a=-40^\circ C$ to $125^\circ C$	-	-	0.05	V
		$R_L=600\Omega$ to $2.5V$	-	0.08	0.15	V
		$R_L=600\Omega$ to $2.5V$, $T_a=-40^\circ C$ to $125^\circ C$	-	-	0.2	V
		$I_{SINK}=2mA$	-	0.04	0.1	V
		$I_{SINK}=2mA$, $T_a=-40^\circ C$ to $125^\circ C$	-	-	0.15	V
Common-Mode Input Voltage Range	V_{ICM}	CMR $\geq 70dB$	0	-	4	V
		CMR $\geq 70dB$, $T_a=-40^\circ C$ to $125^\circ C$	0	-	4	V
Supply Current(All Amplifiers) NJU7076 NJU7077 NJU7078	I_{SUPPLY}	No Signal, $R_L=OPEN$	-	0.6	0.9	mA
		No Signal, $R_L=OPEN$, $T_a=-40^\circ C$ to $125^\circ C$	-	-	0.9	mA
		No Signal, $R_L=OPEN$	-	1.2	1.8	mA
		No Signal, $R_L=OPEN$, $T_a=-40^\circ C$ to $125^\circ C$	-	-	1.8	mA
		No Signal, $R_L=OPEN$	-	2.3	3.5	mA
		No Signal, $R_L=OPEN$, $T_a=-40^\circ C$ to $125^\circ C$	-	-	3.5	mA
AC CHARACTERISTICS						
Gain Bandwidth Product	GBW	$G_V=40dB$, $R_F=100k\Omega$, $R_L=10k\Omega$ to $2.5V$, $C_L=20pF$, $f=100kHz$	-	1.3	-	MHz
Phase Margin	Φ_m	$G_V=40dB$, $R_F=100k\Omega$, $R_L=10k\Omega$ to $2.5V$, $C_L=20pF$	-	60	-	deg
Gain Margin	G_m	$G_V=40dB$, $R_F=100k\Omega$, $R_L=10k\Omega$ to $2.5V$, $C_L=20pF$	-	12	-	dB
Equivalent Input Noise Voltage	e_n	$f=1kHz$	-	10	-	nV/\sqrt{Hz}
Slew Rate	SR	$G_V=0dB$, $R_L=10k\Omega$ to $2.5V$, $C_L=20pF$, $V_{IN}=3V_{PP}$	-	0.5	-	$V/\mu s$
Total Harmonic Distortion + Noise	THD+N	$G_V=20dB$, $R_L=10k\Omega$ to $2.5V$, $f=1kHz$, $V_O=3V_{PP}$	-	0.01	-	%
Channel Separation	CS	$f=1kHz$, NJU7077/NJU7078	-	140	-	dB

(5) Guaranteed by two points of Temperature $-40^\circ C$ and $+125^\circ C$

■ **ELECTRICAL CHARACTERISTICS** ($V^+=2.2V$, $V^-=0V$, $V_{COM}=V^+/2$, $T_a=25^\circ C$, unless otherwise noted.)

PARAMETER	SYMBOL	TEST CONDITION	MIN.	TYP.	MAX.	UNIT
DC CHARACTERISTICS						
Input Offset Voltage NJU7076/NJU7077	V_{IO}	$T_a = -40^\circ C$ to $125^\circ C$	-	60	250	μV
			-	-	400	μV
NJU7078			-	60	300	μV
			-	-	400	μV
Input Offset Voltage Drift	$\Delta V_{IO}/\Delta T$	$T_a = -40^\circ C$ to $125^\circ C$ ⁽⁵⁾	-	0.6	5	$\mu V/^\circ C$
Input Bias Current	I_B		-	1	-	pA
Input Offset Current	I_{IO}		-	1	-	pA
Open-Loop Voltage Gain	A_V	$V_O=0.6V$ to $1.6V$, $R_L=10k\Omega$ to $1.1V$	100	130	-	dB
		$V_O=0.6V$ to $1.6V$, $R_L=10k\Omega$ to $1.1V$, $T_a = -40^\circ C$ to $125^\circ C$	100	-	-	dB
Common-Mode Rejection Ratio	CMR	$V_{ICM}=0V$ to $1.2V$	70	90	-	dB
		$V_{ICM}=0V$ to $1.2V$, $T_a = -40^\circ C$ to $125^\circ C$	70	-	-	dB
High-level Output Voltage	V_{OH}	$R_L=10k\Omega$ to $1.1V$	2.15	2.18	-	V
		$R_L=10k\Omega$ to $1.1V$, $T_a = -40^\circ C$ to $125^\circ C$	2.15	-	-	V
		$R_L=600\Omega$ to $1.1V$	2.1	2.14	-	V
		$R_L=600\Omega$ to $1.1V$, $T_a = -40^\circ C$ to $125^\circ C$	2.05	-	-	V
		$I_{SOURCE}=2mA$	2.05	2.13	-	V
		$I_{SOURCE}=2mA$, $T_a = -40^\circ C$ to $125^\circ C$	2	-	-	V
Low-level Output Voltage	V_{OL}	$R_L=10k\Omega$ to $1.1V$	-	0.02	0.05	V
		$R_L=10k\Omega$ to $1.1V$, $T_a = -40^\circ C$ to $125^\circ C$	-	-	0.05	V
		$R_L=600\Omega$ to $1.1V$	-	0.06	0.1	V
		$R_L=600\Omega$ to $1.1V$, $T_a = -40^\circ C$ to $125^\circ C$	-	-	0.15	V
		$I_{SINK}=2mA$	-	0.07	0.15	V
		$I_{SINK}=2mA$, $T_a = -40^\circ C$ to $125^\circ C$	-	-	0.2	V
Common-Mode Input Voltage Range	V_{ICM}	CMR $\geq 70dB$	0	-	1.2	V
		CMR $\geq 70dB$, $T_a = -40^\circ C$ to $125^\circ C$	0	-	1.2	V
Supply Current(All Amplifiers)	I_{SUPPLY}	No Signal, $R_L=OPEN$	-	0.55	0.82	mA
NJU7076		No Signal, $R_L=OPEN$, $T_a = -40^\circ C$ to $125^\circ C$	-	-	0.82	mA
NJU7077		No Signal, $R_L=OPEN$	-	1.0	1.5	mA
		No Signal, $R_L=OPEN$, $T_a = -40^\circ C$ to $125^\circ C$	-	-	1.5	mA
NJU7078		No Signal, $R_L=OPEN$	-	2.0	3.0	mA
		No Signal, $R_L=OPEN$, $T_a = -40^\circ C$ to $125^\circ C$	-	-	3.0	mA
AC CHARACTERISTICS						
Gain Bandwidth Product	GBW	$G_V=40dB$, $R_F=100k\Omega$, $R_L=10k\Omega$ to $1.1V$, $C_L=20pF$, $f=100kHz$	-	1.2	-	MHz
Phase Margin	Φ_m	$G_V=40dB$, $R_F=100k\Omega$, $R_L=10k\Omega$ to $1.1V$, $C_L=20pF$	-	60	-	deg
Gain Margin	G_m	$G_V=40dB$, $R_F=100k\Omega$, $R_L=10k\Omega$ to $1.1V$, $C_L=20pF$	-	12	-	dB
Equivalent Input Noise Voltage	e_n	$f=1kHz$	-	10	-	nV/\sqrt{Hz}
Slew Rate	SR	$G_V=0dB$, $R_L=10k\Omega$ to $1.1V$, $C_L=20pF$, $V_{IN}=1V_{PP}$	-	0.5	-	$V/\mu s$
Total Harmonic Distortion + Noise	THD+N	$G_V=20dB$, $R_L=10k\Omega$ to $1.1V$, $f=1kHz$, $V_O=1V_{PP}$	-	0.01	-	%
Channel Separation	CS	$f=1kHz$, NJU7077/NJU7078	-	140	-	dB

(5) Guaranteed by two points of Temperature $-40^\circ C$ and $+125^\circ C$

■ TYPICAL CHARACTERISTICS

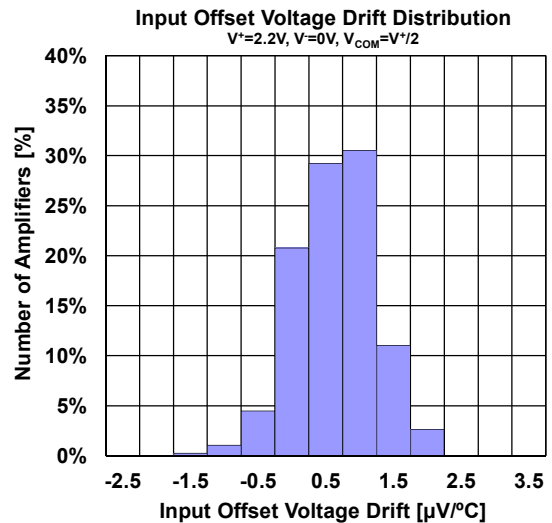
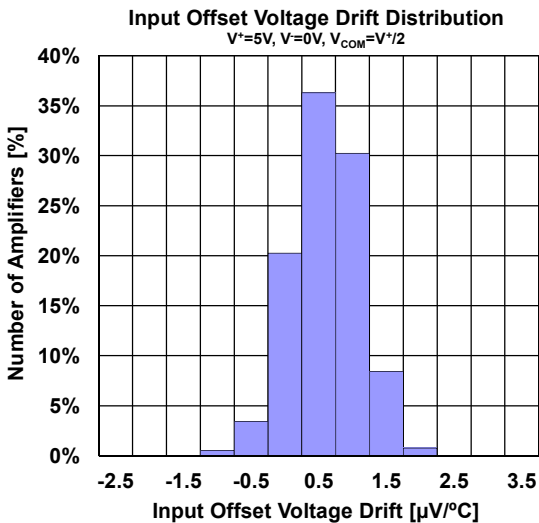
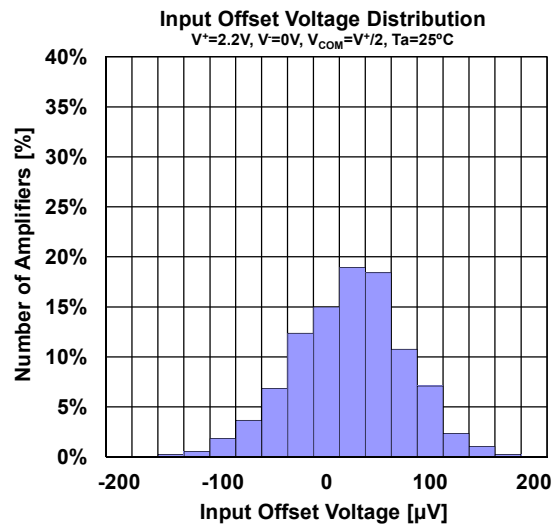
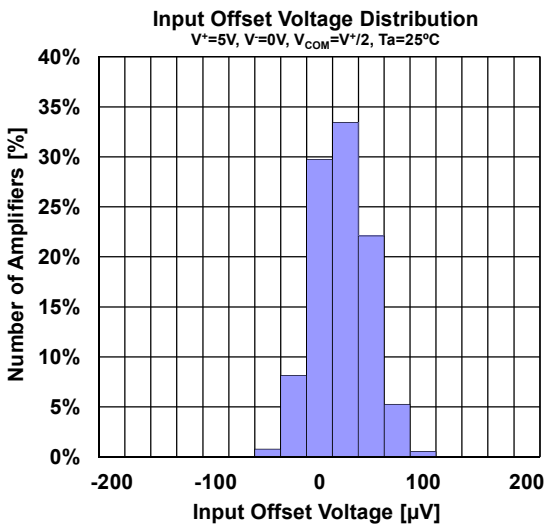
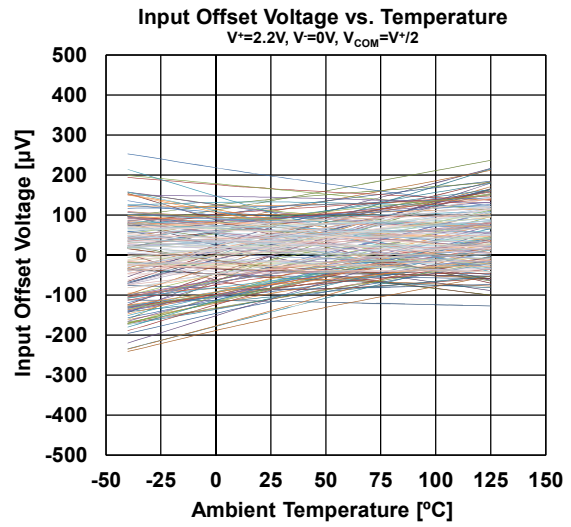
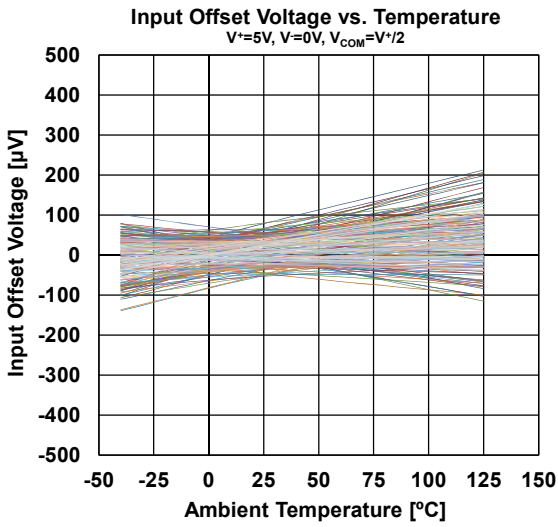

TYPICAL CHARACTERISTICS

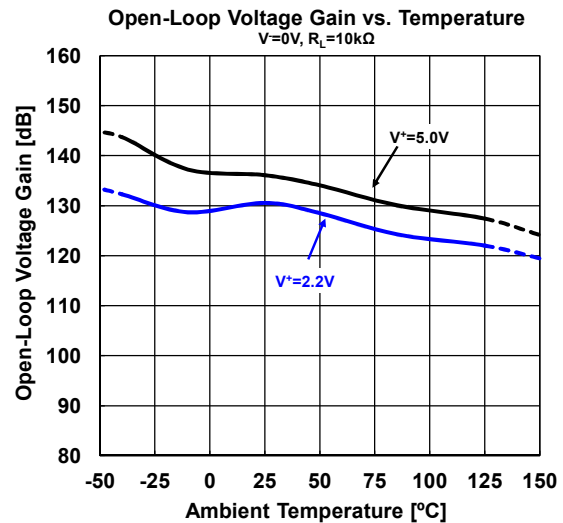
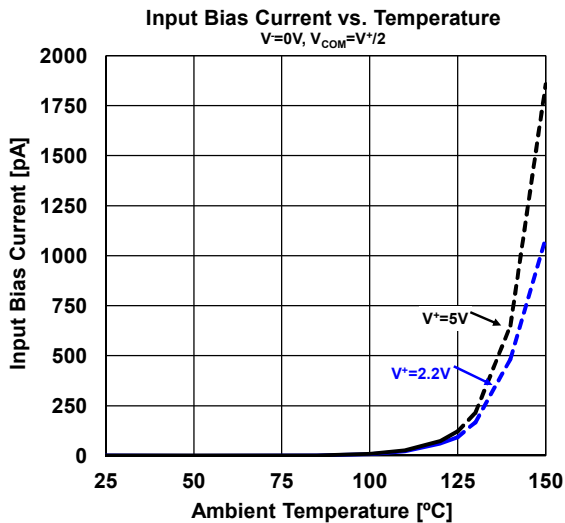
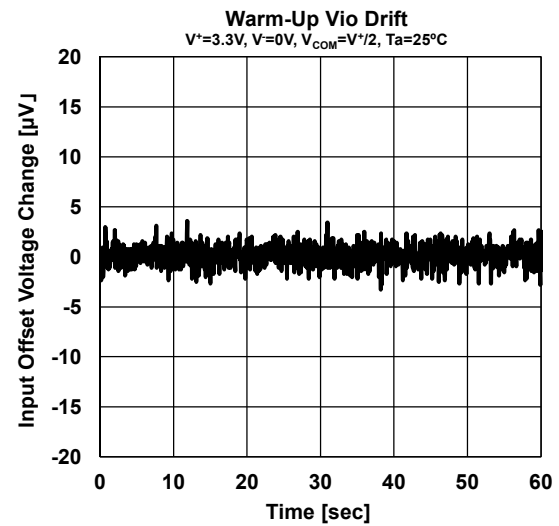
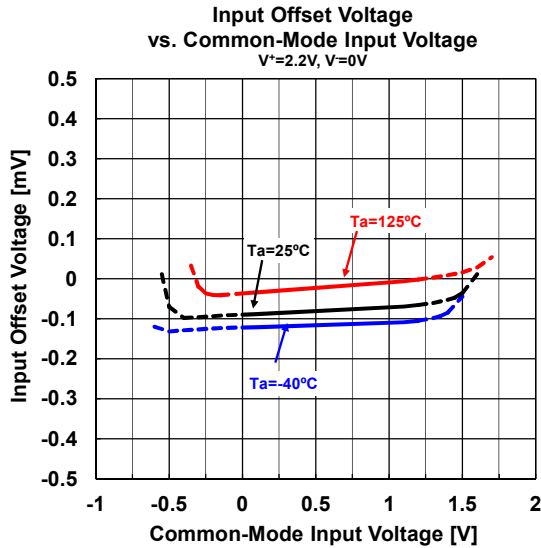
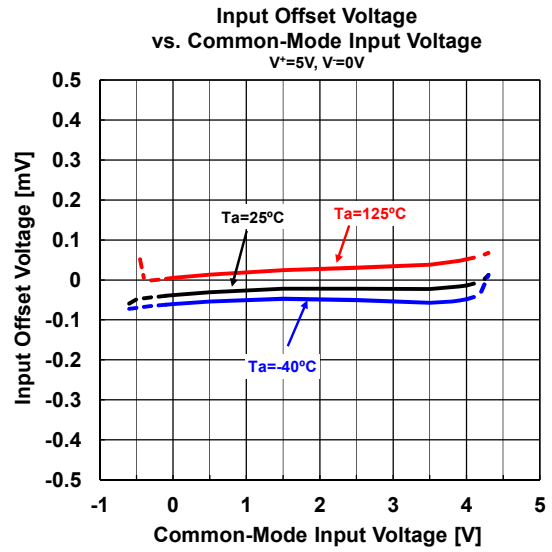
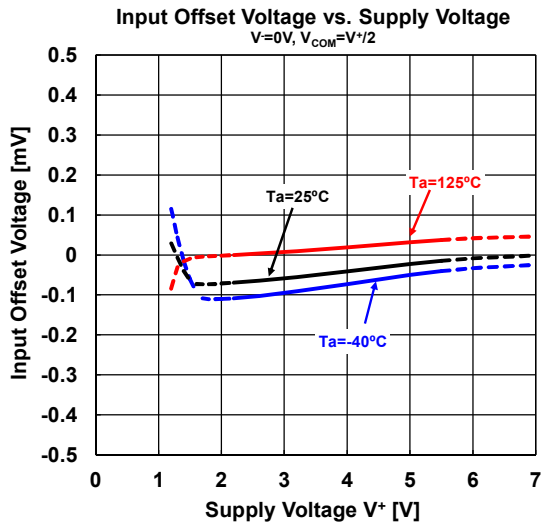

■ TYPICAL CHARACTERISTICS

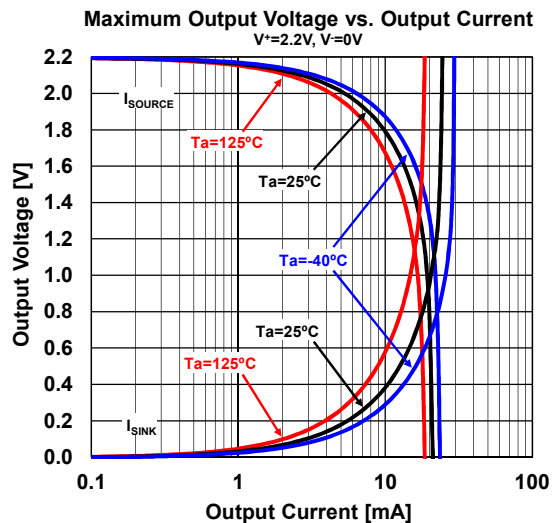
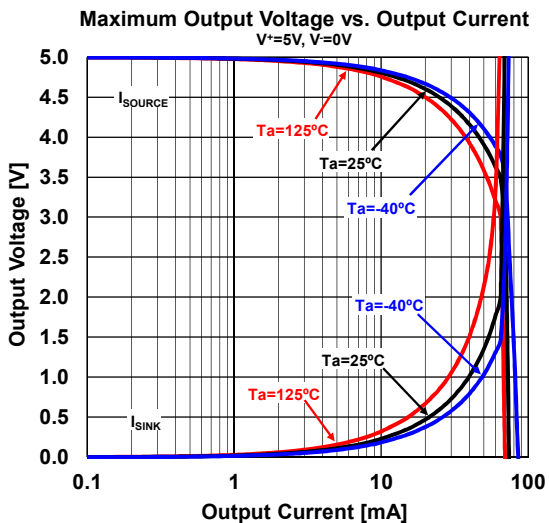
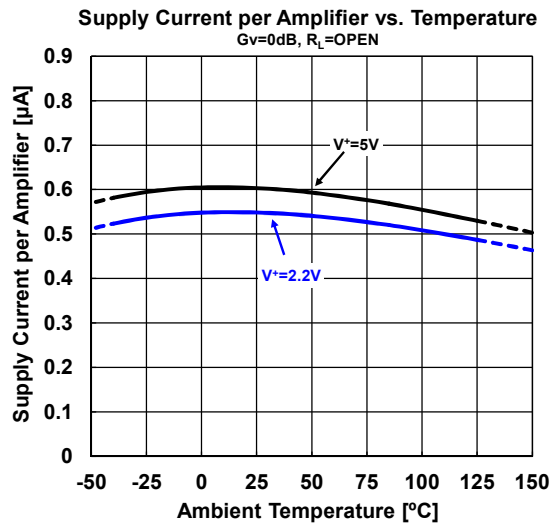
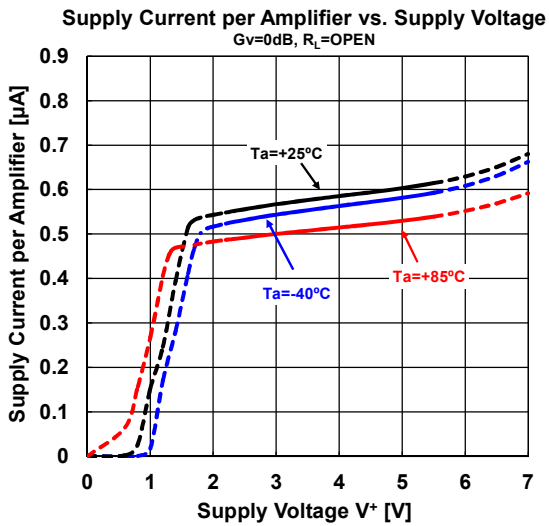
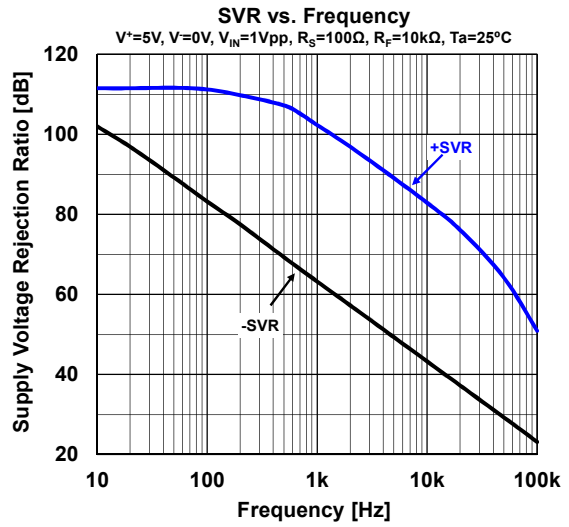
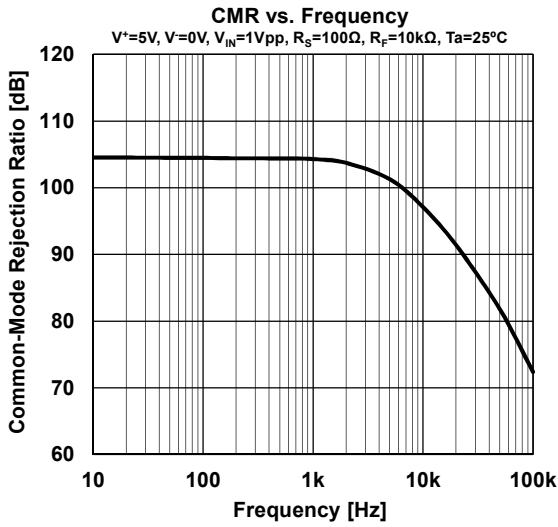

■ TYPICAL CHARACTERISTICS

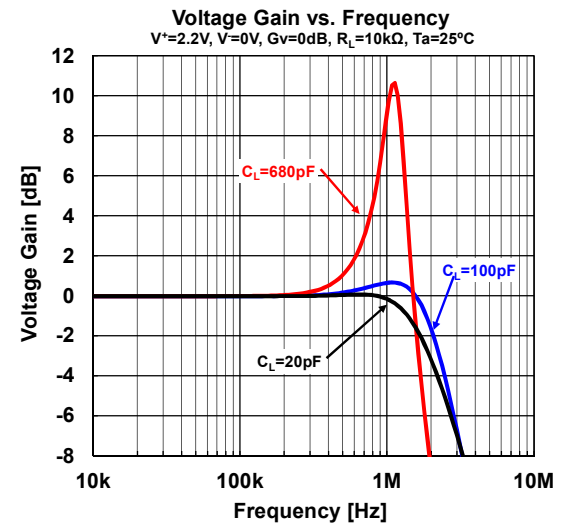
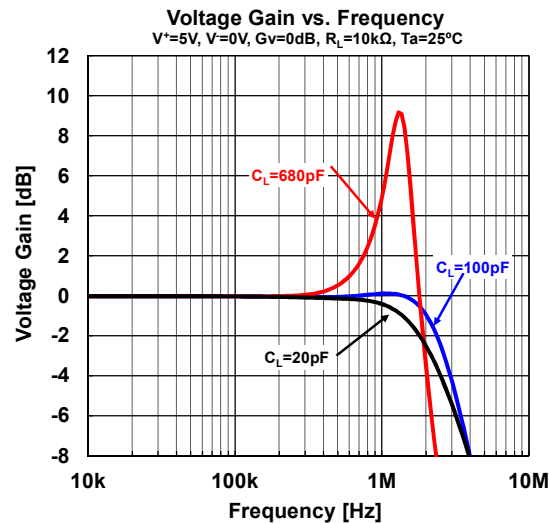
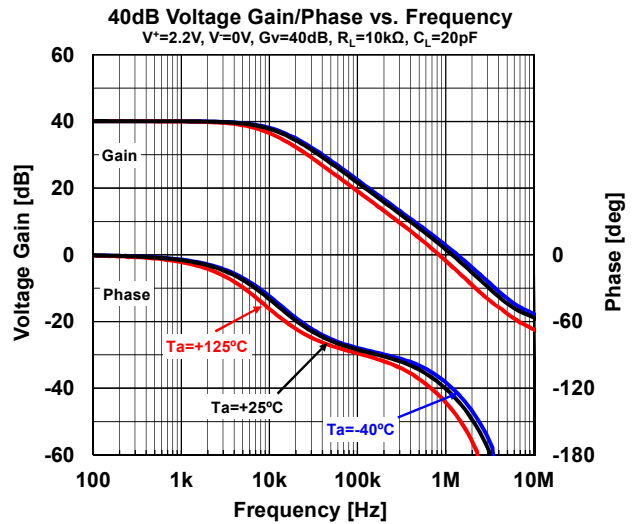
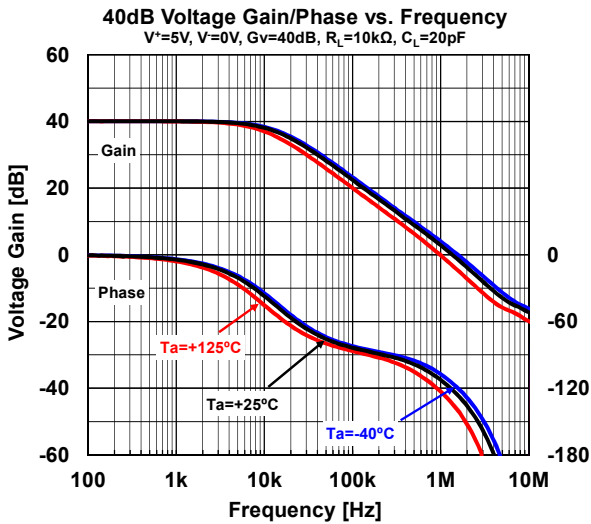
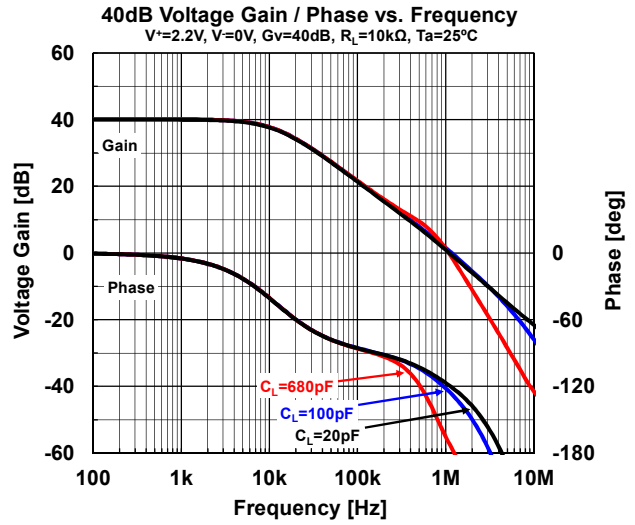
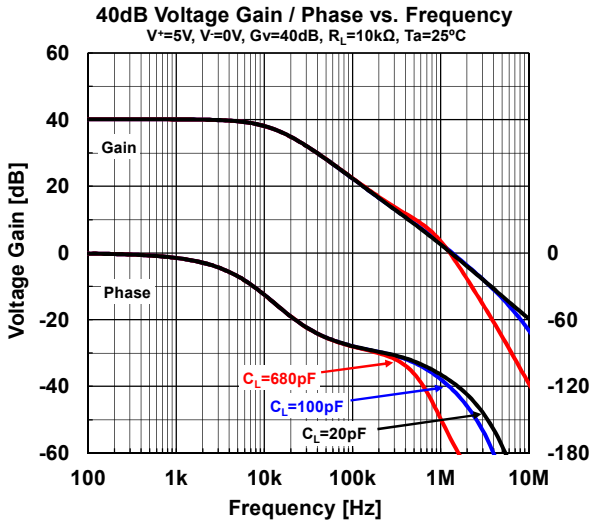

■ TYPICAL CHARACTERISTICS

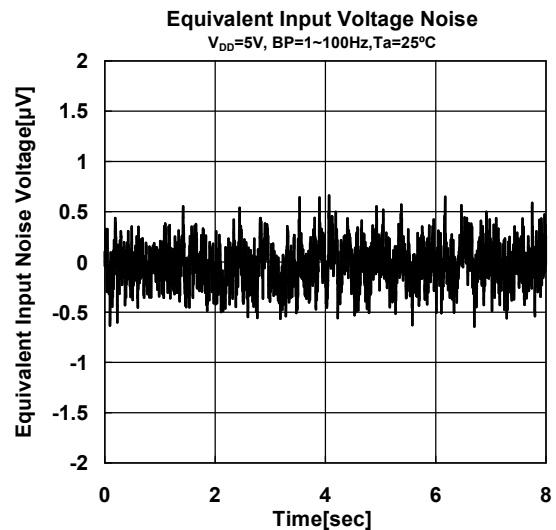
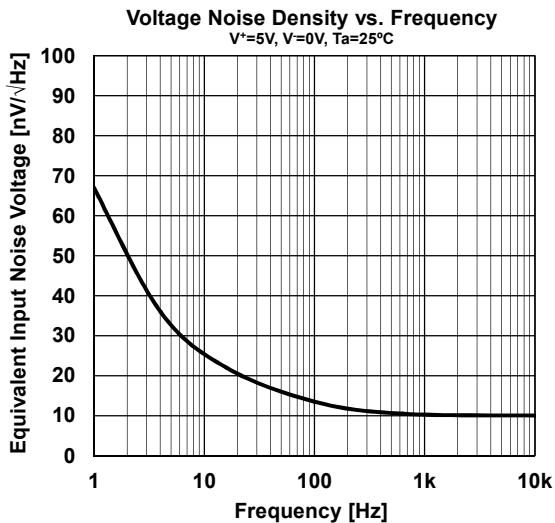
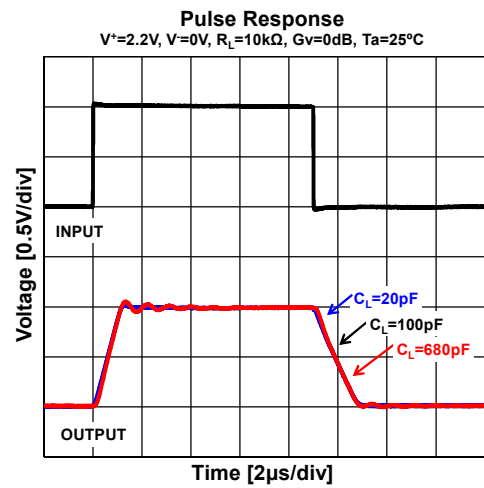
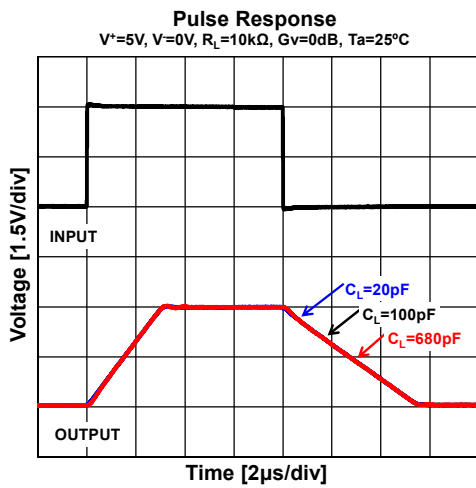
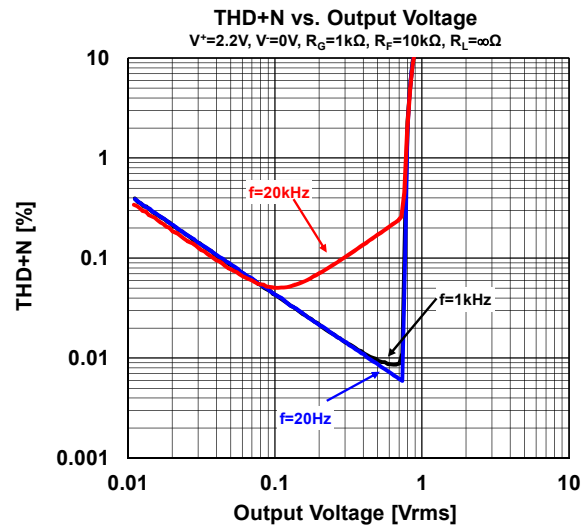
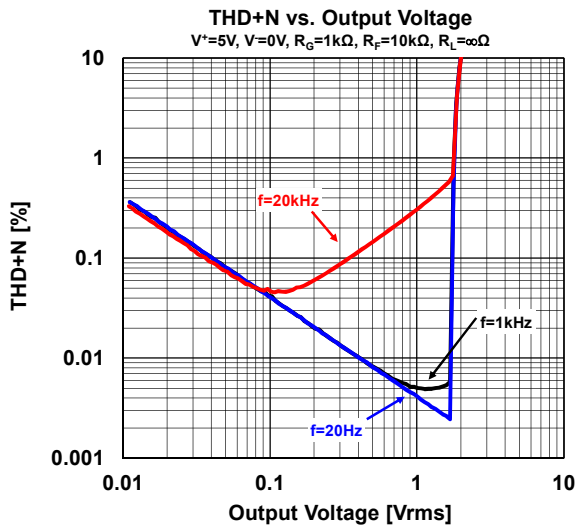

■ TYPICAL CHARACTERISTICS

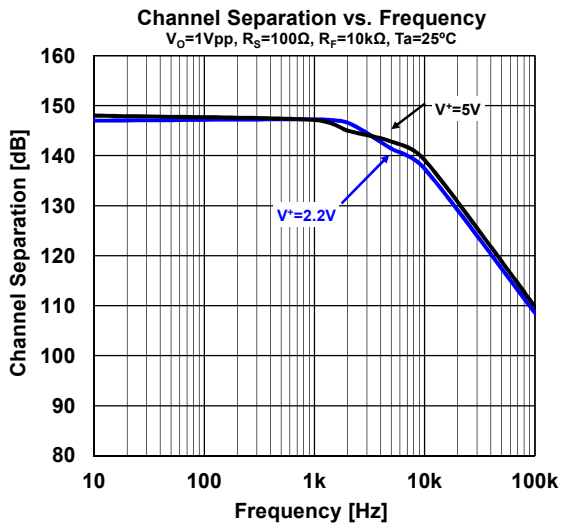

■ PACKAGE DIMENSIONS

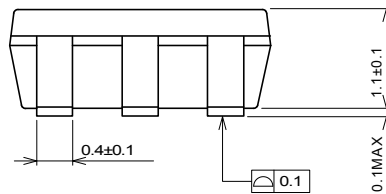
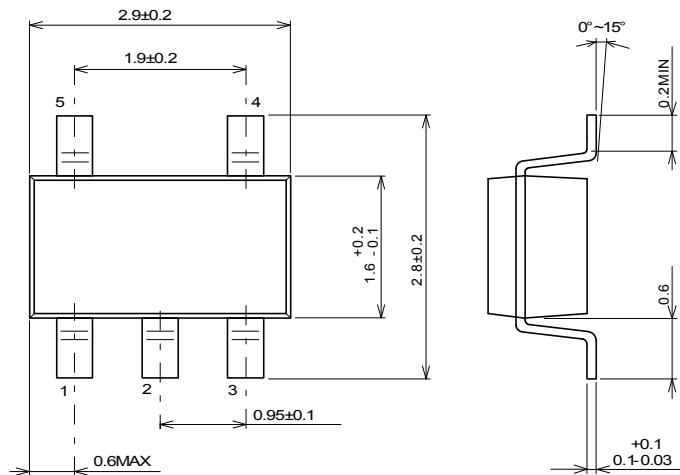

Unit: mm

SOT-23-5 Package

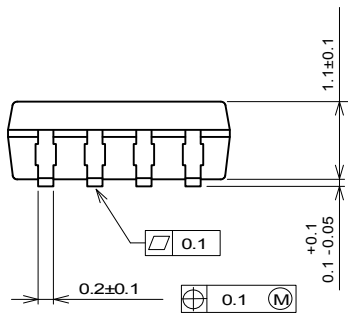
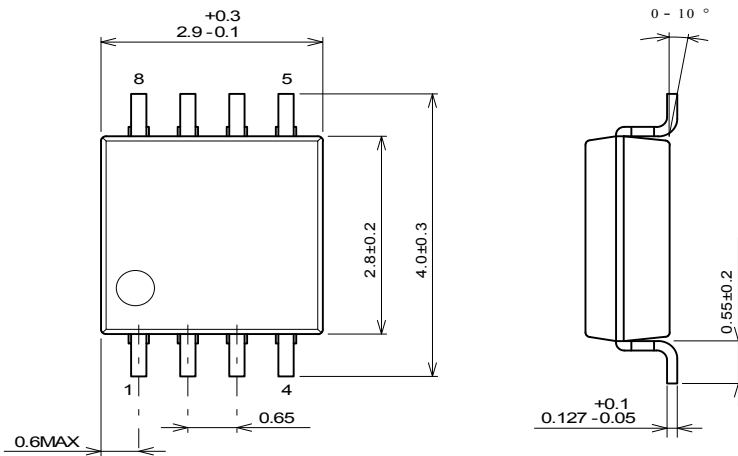

Unit: mm

MSOP8(VSP8)* Package
*MEET JEDEC MO-187-DA

■ PACKAGE DIMENSIONS

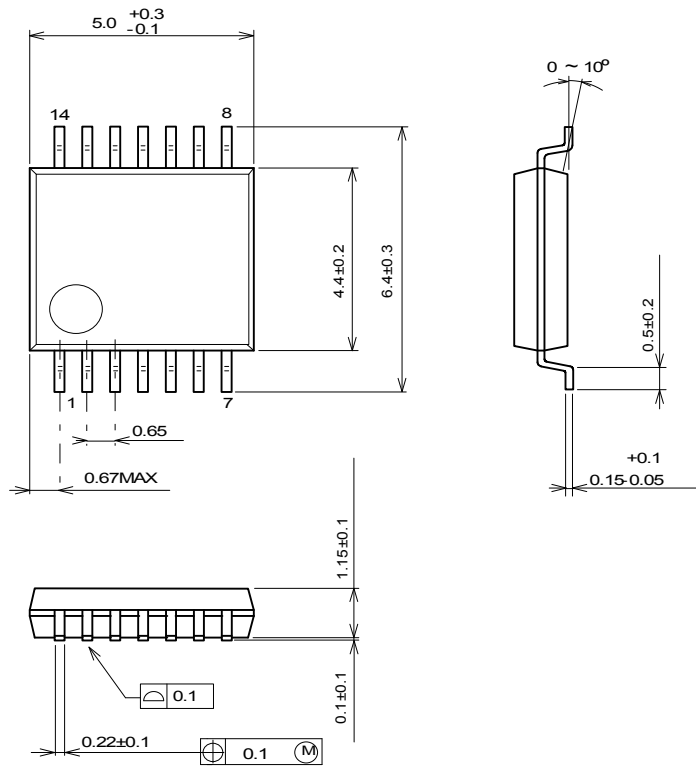

Unit: mm

SSOP14 Package

[CAUTION]
 The specifications on this databook are only given for information, without any guarantee as regards either mistakes or omissions. The application circuits in this databook are described only to show representative usages of the product and not intended for the guarantee or permission of any right including the industrial rights.