

0.05 μ V/ $^{\circ}$ C max, Zero-Drift, Single Supply Rail-to-Rail Output CMOS Operational Amplifier

FEATURES ($V^+=5V$ typ.)

- Low Offset Voltage 15 μ V max.
- Zero-Drift 0.05 μ V/ $^{\circ}$ C max.
- Supply Voltage Range 3V to 10V
- Rail-to-Rail Output ($R_L=10k\Omega$) 20mV from rail
- Output Current ($V_o=4.5V$ at $V^+=5V$) 30mA
- DC Precision
- Open-Loop Voltage Gain 140dB
- CMR, SVR 130dB
- Supply Current 0.6mA
- Shutdown
- RF-Noise immunity
- Ground Sense
- Overload Recovery Time 0.45ms
- Package SOT-23-6-1

APPLICATIONS

- Thermocouple Amplifiers
- Electronic Scales
- Strain Gauge Amplifiers
- Medical Instrumentation
- Precision Current Sensing
- High Resolution Data Acquisition
- Low-Side Current Sensing
- Handheld Test Equipment

DESCRIPTION

The NJU7098A is a low offset voltage and zero-drift operational amplifier. With an maximum input offset voltage of 15 μ V and offset drift of 0.05 μ V/ $^{\circ}$ C, The NJU7098A is suitable for applications in which error sources cannot be tolerated.

The NJU7098A operate from 3V to 10V with single supply. Rail-to-rail output swing, input common mode voltage within negative rail and 30mA high output current capability provided by the NJU7098A make low-side sensing or precision output buffer easy.

The almost zero DC offset and offset drift are supported with a power supply rejection ratio and common mode rejection ratio at 130dB. Furthermore, typical open-loop voltage gain is 140dB.

The NJU7098 includes a shutdown mode. Under logic control, the amplifiers can be switched from normal operation to shutdown current that is 15 μ A max and the output placed in a high-impedance state.

The NJU7098A is available in 6-pin SOT-23 package.

PIN CONFIGURATION

Pin Function	<p>(Top View)</p>
Package	<p>SOT-23-6-1</p>
Product Name	NJU7098AF1

■ ABSOLUTE MAXIMUM RATINGS

PARAMETER	SYMBOL	RATING	UNIT
Supply Voltage	$V^+ - V^-$	11	V
Input Voltage	V_{IN}	$V^- - 0.3$ to $V^+ + 0.3$	V
Differential Input Voltage ⁽¹⁾	V_{ID}	± 11 ⁽²⁾	V
Power Dissipation ⁽³⁾ SOT-23-6-1	P_D	2-Layer / 4-Layer 410 / 580	mW
Operating Temperature Range	T_{OPR}	-40 to +105	°C
Storage Temperature Range	T_{STG}	-40 to +125	°C

(1) Differential voltage is the voltage difference between +INPUT and -INPUT.

(2) For supply voltage less than 11V, the absolute maximum input voltage is equal to supply voltage.

(3) Power dissipation is the power that can be consumed by the IC at $T_a=25^\circ\text{C}$, and is the typical measured value based on JEDEC condition. When using the IC over $T_a=25^\circ\text{C}$ subtract the value $[\text{mW}/^\circ\text{C}] = P_D / (T_{stg}(\text{MAX}) - 25)$ per temperature.

2-layer: EIA/JEDEC STANDARD Test board (76.2x114.3x1.6mm, 2 layers, FR-4) mounting

4-layer: EIA/JEDEC STANDARD Test board (76.2x114.3x1.6mm, 4 layers, FR-4) mounting

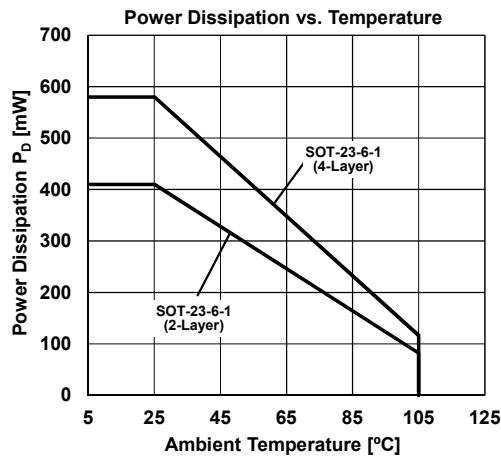

■ RECOMMENDED OPERATING CONDITIONS ($T_a=25^\circ\text{C}$)

PARAMETER	CONDITION	MIN.	TYP.	MAX.	UNIT
Supply Voltage		3		10	V

■ ELECTRICAL CHARACTERISTICS ($V^+=3V$, $V^-=0V$, $V_{SHDN}=V^+$, $T_a=25^\circ C$, unless otherwise noted.)

PARAMETER	SYMBOL	TEST CONDITION	MIN.	TYP.	MAX.	UNIT
DC CHARACTERISTICS						
Input Offset Voltage ⁽⁴⁾	V_{IO}	$T_a=-40^\circ C$ to $85^\circ C$	-	3	15	μV
Input Offset Voltage Drift ⁽⁴⁾	$V_{IO}/\Delta T$	$T_a=-40^\circ C$ to $85^\circ C$	-	-	0.05	$\mu V/^\circ C$
Input Bias Current	I_B	$T_a=-40^\circ C$ to $85^\circ C$	-	15	400	pA
			-	-	1000	pA
Input Offset Current	I_{IO}	$T_a=-40^\circ C$ to $85^\circ C$	-	-	500	pA
			-	-	1000	pA
Open-Loop Voltage Gain	A_V	$R_L \geq 10k\Omega$, $V_O=0.35$ to $2.65V$ $T_a=-40^\circ C$ to $85^\circ C$	120	140	-	dB
			115	140	-	dB
Common-Mode Input Voltage Range	V_{ICM}	$CMR \geq 110dB$, $T_a=-40^\circ C$ to $85^\circ C$	0	-	1.7	V
Common-Mode Rejection Ratio	CMR	$V_{ICM}=0$ to $1.7V$ $T_a=-40^\circ C$ to $85^\circ C$	110	130		dB
			110	130		dB
Supply Voltage Rejection Ratio	SVR	$V^+=3$ to $10V$ $T_a=-40^\circ C$ to $85^\circ C$	110	130	-	dB
			110	130	-	dB
High-level Output Voltage	V_{OH}	$R_L=10k\Omega$ to $0V$, $T_a=-40^\circ C$ to $85^\circ C$ $R_L=2k\Omega$ to $0V$, $T_a=-40^\circ C$ to $85^\circ C$	2.95	2.98	-	V
			2.85	2.94	-	V
Low-level Output Voltage	V_{OL}	$R_L=10k\Omega$ to $0V$, $T_a=-40^\circ C$ to $85^\circ C$ $R_L=2k\Omega$ to $0V$, $T_a=-40^\circ C$ to $85^\circ C$	-	1	10	mV
			-	1	10	mV
Output Source Current	I_{SOURCE}	$V_O=2.5V$, $T_a=-40^\circ C$ to $85^\circ C$	5	20	-	mA
Output Sink Current	I_{SINK}	$V_O=0.5V$, $T_a=-40^\circ C$ to $85^\circ C$	3	25	-	mA
Supply Current		No Signal, $T_a=-40^\circ C$ to $85^\circ C$				
Normally Mode	I_{SUPPLY}	$V_{SHDN}=3V$	-	0.55	1.1	mA
Shutdown Mode		$V_{SHDN}=0V$	-	-	10	μA
Shutdown Pin Input High Voltage	V_{SHDNON}	$I_{SUPPLY} \geq 300\mu A$, $T_a=-40^\circ C$ to $85^\circ C$	2.5	-	3	V
Shutdown Pin Input Low Voltage	$V_{SHDNOFF}$	$I_{SUPPLY} \leq 10\mu A$, $T_a=-40^\circ C$ to $85^\circ C$	0	-	0.5	V
Shutdown Pin Input Current	I_{SHDN}	$V_{SHDN}=0V$, $T_a=-40^\circ C$ to $85^\circ C$	-	0.5	3	μA
AC CHARACTERISTICS						
Gain Bandwidth Product	GBW	$R_L=10k\Omega$	-	2	-	MHz
Positive Slew Rate	+SR	$G_V=+1$, $R_L=10k\Omega$	-	3	-	V/ μs
Negative Slew Rate	-SR	$G_V=+1$, $R_L=10k\Omega$	-	8	-	V/ μs
Phase Margin	Φ_M	$R_L=10k\Omega$, $C_L=50pF$	-	30	-	deg
Equivalent Input Noise Voltage	V_{NI}	$f=10Hz$	-	120	-	nV/ \sqrt{Hz}
Internal Sampling Frequency	F_S		-	7.5	-	kHz

(4) These parameters are guaranteed by design.

■ ELECTRICAL CHARACTERISTICS ($V^+=5V$, $V^-=0V$, $V_{SHDN}=V^+$, $T_a=25^\circ C$, unless otherwise noted.)

PARAMETER	SYMBOL	TEST CONDITION	MIN.	TYP.	MAX.	UNIT
DC CHARACTERISTICS						
Input Offset Voltage ⁽⁴⁾	V_{IO}		-	3	15	μV
Input Offset Voltage Drift ⁽⁴⁾	$V_{IO}/\Delta T$	$T_a=-40^\circ C$ to $85^\circ C$	-	-	0.05	$\mu V/^\circ C$
Input Bias Current	I_B	$T_a=-40^\circ C$ to $85^\circ C$	-	20	400	pA
			-	-	1000	pA
Input Offset Current	I_{IO}	$T_a=-40^\circ C$ to $85^\circ C$	-	-	500	pA
			-	-	1000	pA
Open-Loop Voltage Gain	A_V	$R_L \geq 10k\Omega$, $V_O=1$ to $4V$ $T_a=-40^\circ C$ to $85^\circ C$	125	140	-	dB
			120	140	-	dB
Common-Mode Input Voltage Range	V_{ICM}	$CMR \geq 115dB$, $T_a=-40^\circ C$ to $85^\circ C$	0	-	3.5	V
Common-Mode Rejection Ratio	CMR	$V_{ICM}=0$ to $3.5V$ $T_a=-40^\circ C$ to $85^\circ C$	120	130		dB
			115	130		dB
Supply Voltage Rejection Ratio	SVR	$V^+=4$ to $10V$ $T_a=-40^\circ C$ to $85^\circ C$	115	130	-	dB
			115	130	-	dB
High-level Output Voltage	V_{OH}	$R_L=10k\Omega$ to $0V$, $T_a=-40^\circ C$ to $85^\circ C$ $R_L=2k\Omega$ to $0V$, $T_a=-40^\circ C$ to $85^\circ C$	4.95	4.98	-	V
			4.85	4.94	-	V
Low-level Output Voltage	V_{OL}	$R_L=10k\Omega$ to $0V$, $T_a=-40^\circ C$ to $85^\circ C$ $R_L=2k\Omega$ to $0V$, $T_a=-40^\circ C$ to $85^\circ C$	-	1	10	mV
			-	1	10	mV
Output Source Current	I_{SOURCE}	$V_O=4.5V$, $T_a=-40^\circ C$ to $85^\circ C$	10	30	-	mA
Output Sink Current	I_{SINK}	$V_O=0.5V$, $T_a=-40^\circ C$ to $85^\circ C$	4	40	-	mA
Supply Current		No Signal, $T_a=-40^\circ C$ to $85^\circ C$				
Normally Mode	I_{SUPPLY}	$V_{SHDN}=5V$	-	0.6	1.2	mA
Shutdown Mode		$V_{SHDN}=0V$	-	-	15	μA
Shutdown Pin Input High Voltage	V_{SHDNON}	$I_{SUPPLY} \geq 300\mu A$, $T_a=-40^\circ C$ to $85^\circ C$	4.5	-	5	V
Shutdown Pin Input Low Voltage	$V_{SHDNOFF}$	$I_{SUPPLY} \leq 10\mu A$, $T_a=-40^\circ C$ to $85^\circ C$	0	-	0.5	V
Shutdown Pin Input Current	I_{SHDN}	$V_{SHDN}=0V$, $T_a=-40^\circ C$ to $85^\circ C$	-	2	7	μA
AC CHARACTERISTICS						
Gain Bandwidth Product	GBW	$R_L=10k\Omega$	-	3	-	MHz
Positive Slew Rate	+SR	$G_V=+1$, $R_L=10k\Omega$	-	3	-	V/ μs
Negative Slew Rate	-SR	$G_V=+1$, $R_L=10k\Omega$	-	12	-	V/ μs
Phase Margin	Φ_M	$R_L=10k\Omega$, $C_L=50pF$	-	30	-	deg
Equivalent Input Noise Voltage	V_{NI}	$f=10Hz$	-	120	-	nV/ \sqrt{Hz}
Internal Sampling Frequency	F_S		-	7.5	-	kHz

(4) These parameters are guaranteed by design.

■ ELECTRICAL CHARACTERISTICS ($V^+=10V$, $V^-=0V$, $V_{SHDN}=V^+$, $T_a=25^\circ C$, unless otherwise noted.)

PARAMETER	SYMBOL	TEST CONDITION	MIN.	TYP.	MAX.	UNIT
DC CHARACTERISTICS						
Input Offset Voltage ⁽⁴⁾	V_{IO}		-	3	15	μV
Input Offset Voltage Drift ⁽⁴⁾	$V_{IO}/\Delta T$	$T_a=-40^\circ C$ to $85^\circ C$	-	-	0.05	$\mu V/^\circ C$
Input Bias Current	I_B	$T_a=-40^\circ C$ to $85^\circ C$	-	40	400	pA
			-	-	1000	pA
Input Offset Current	I_{IO}	$T_a=-40^\circ C$ to $85^\circ C$	-	-	500	pA
			-	-	1000	pA
Open-Loop Voltage Gain	A_V	$R_L \geq 10k\Omega$, $V_O=1$ to $9V$ $T_a=-40^\circ C$ to $85^\circ C$	125	140	-	dB
			120	140	-	dB
Common-Mode Input Voltage Range	V_{ICM}	$CMR \geq 115dB$, $T_a=-40^\circ C$ to $85^\circ C$	0	-	8.5	V
Common-Mode Rejection Ratio	CMR	$V_{ICM}=0$ to $8.5V$ $T_a=-40^\circ C$ to $85^\circ C$	120	130		dB
			115	130		dB
Supply Voltage Rejection Ratio	SVR	$V^+=4$ to $10V$ $T_a=-40^\circ C$ to $85^\circ C$	115	130	-	dB
			115	130	-	dB
High-level Output Voltage	V_{OH}	$R_L=10k\Omega$ to $0V$, $T_a=-40^\circ C$ to $85^\circ C$ $R_L=2k\Omega$ to $0V$, $T_a=-40^\circ C$ to $85^\circ C$	9.6	9.98	-	V
			9.5	9.94	-	V
Low-level Output Voltage	V_{OL}	$R_L=10k\Omega$ to $0V$, $T_a=-40^\circ C$ to $85^\circ C$ $R_L=2k\Omega$ to $0V$, $T_a=-40^\circ C$ to $85^\circ C$	-	1	10	mV
			-	1	10	mV
Output Source Current	I_{SOURCE}	$V_O=9.5V$, $T_a=-40^\circ C$ to $85^\circ C$	14	40	-	mA
Output Sink Current	I_{SINK}	$V_O=0.5V$, $T_a=-40^\circ C$ to $85^\circ C$	5	60	-	mA
Supply Current		No Signal, $T_a=-40^\circ C$ to $85^\circ C$				
Normally Mode	I_{SUPPLY}	$V_{SHDN}=10V$	-	0.7	1.5	mA
Shutdown Mode		$V_{SHDN}=0V$	-	-	25	μA
Shutdown Pin Input High Voltage	V_{SHDNON}	$I_{SUPPLY} \geq 400\mu A$, $T_a=-40^\circ C$ to $85^\circ C$	9.5	-	10	V
Shutdown Pin Input Low Voltage	$V_{SHDNOFF}$	$I_{SUPPLY} \leq 25\mu A$, $T_a=-40^\circ C$ to $85^\circ C$	0	-	0.5	V
Shutdown Pin Input Current	I_{SHDN}	$V_{SHDN}=0V$, $T_a=-40^\circ C$ to $85^\circ C$	-	7.5	20	μA
AC CHARACTERISTICS						
Gain Bandwidth Product	GBW	$R_L=10k\Omega$	-	5	-	MHz
Positive Slew Rate	+SR	$G_V=+1$, $R_L=10k\Omega$	-	4	-	V/ μs
Negative Slew Rate	-SR	$G_V=+1$, $R_L=10k\Omega$	-	14	-	V/ μs
Phase Margin	Φ_M	$R_L=10k\Omega$, $C_L=50pF$	-	30	-	deg
Equivalent Input Noise Voltage	V_{NI}	$f=10Hz$	-	120	-	nV/ \sqrt{Hz}
Internal Sampling Frequency	F_S		-	7.5	-	kHz

(4) These parameters are guaranteed by design.

■ TYPICAL CHARACTERISTICS

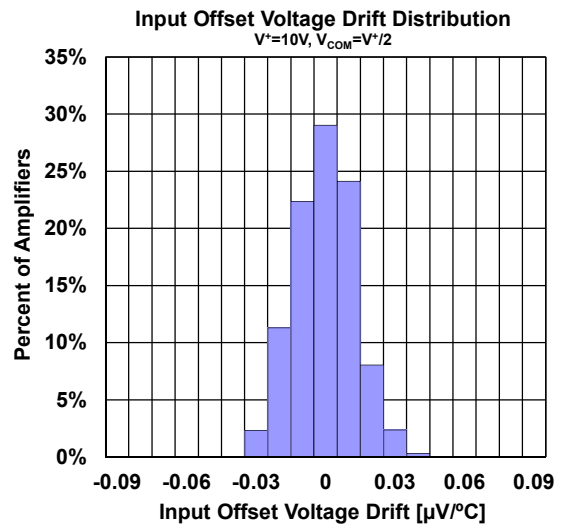
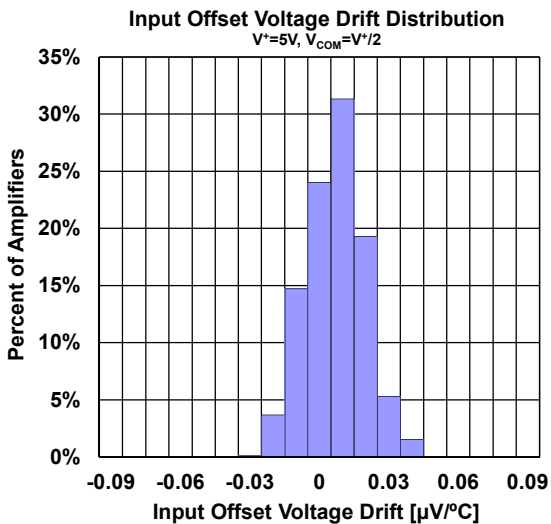
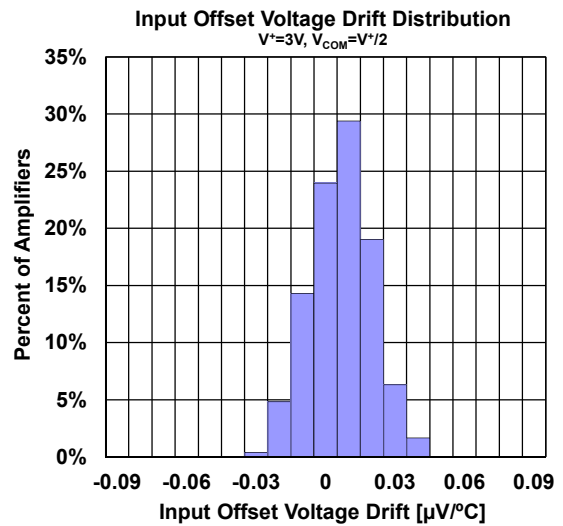
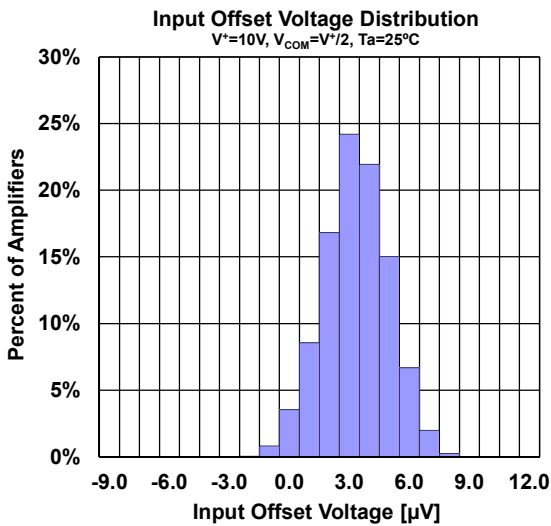
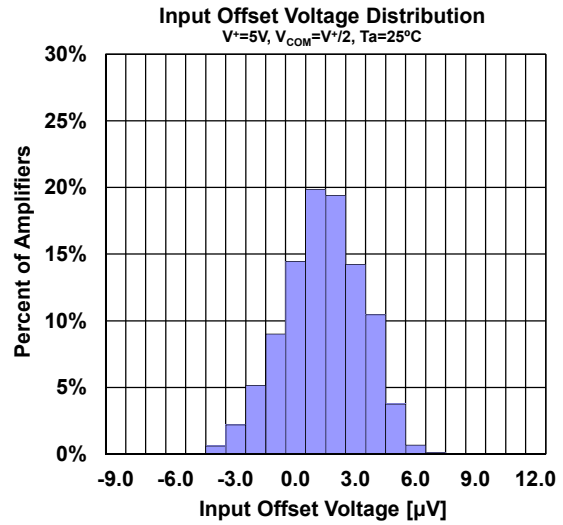
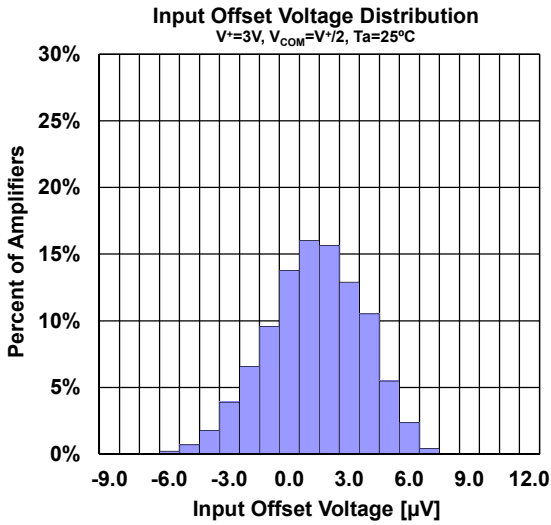

■ TYPICAL CHARACTERISTICS

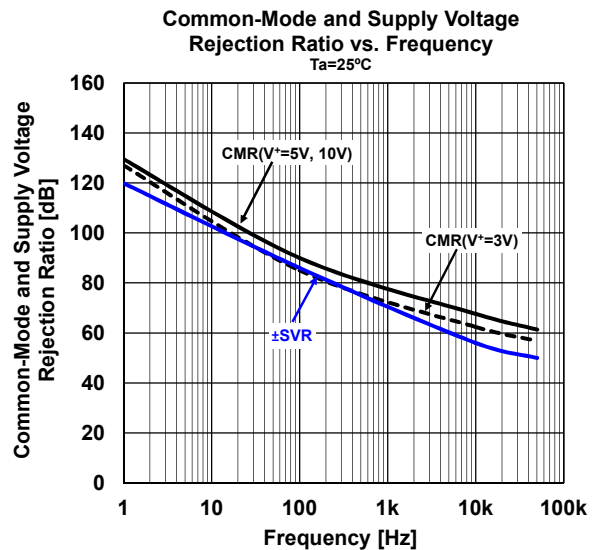
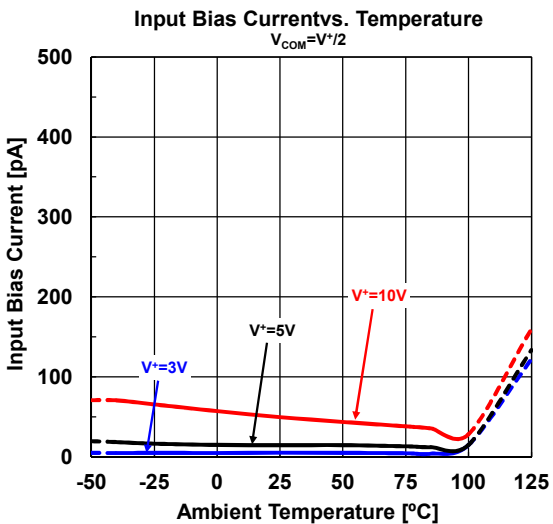
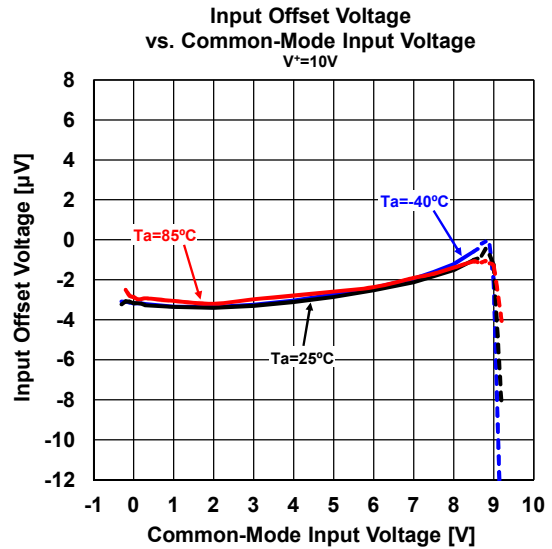
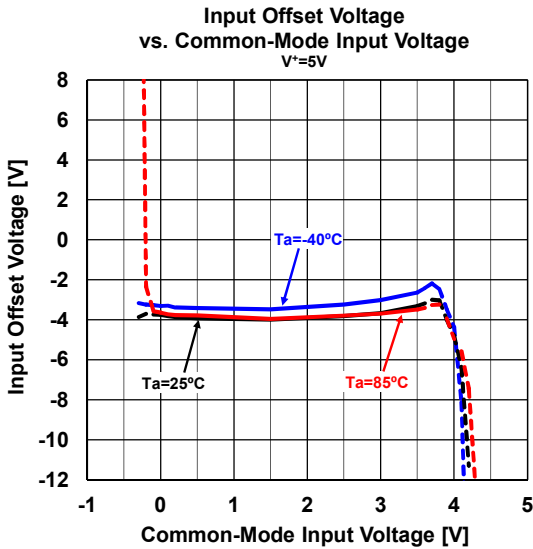
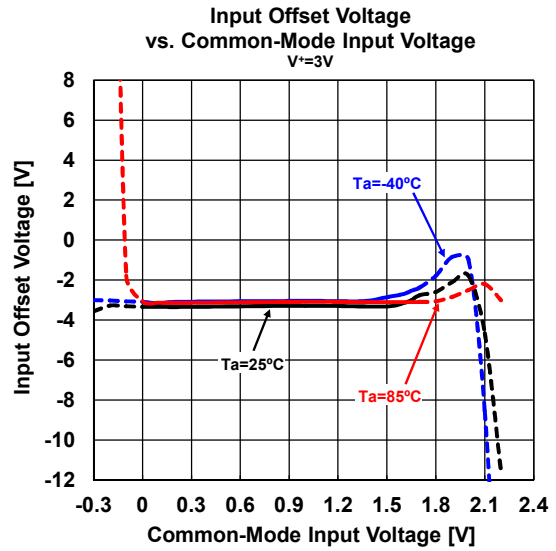
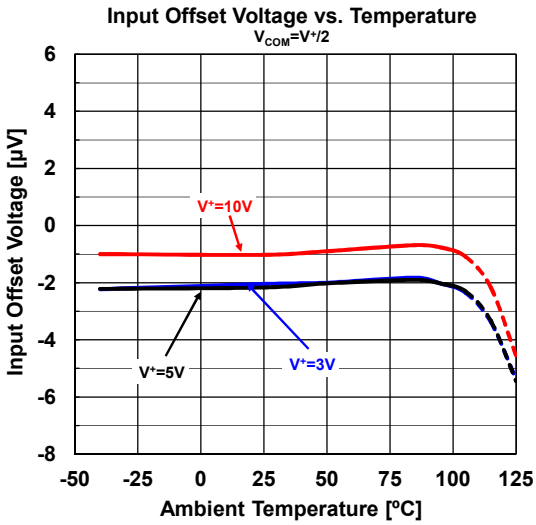

■ TYPICAL CHARACTERISTICS

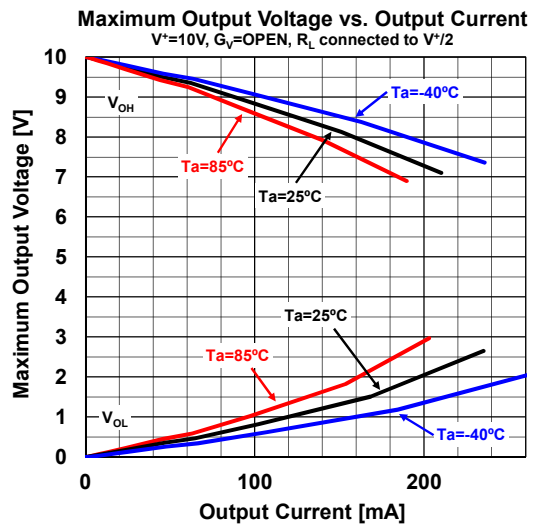
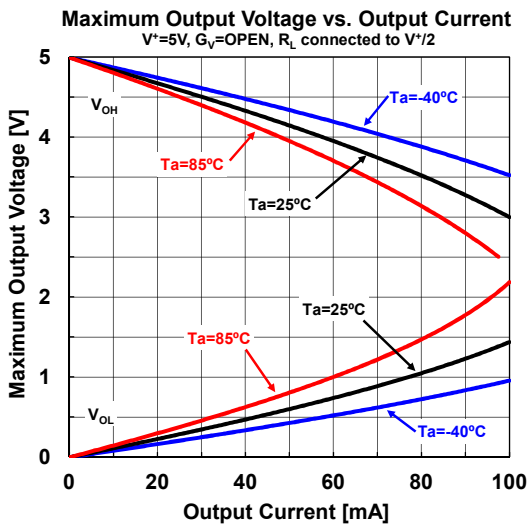
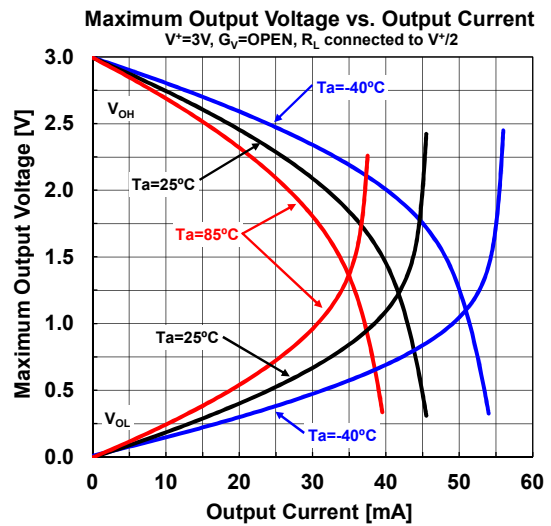
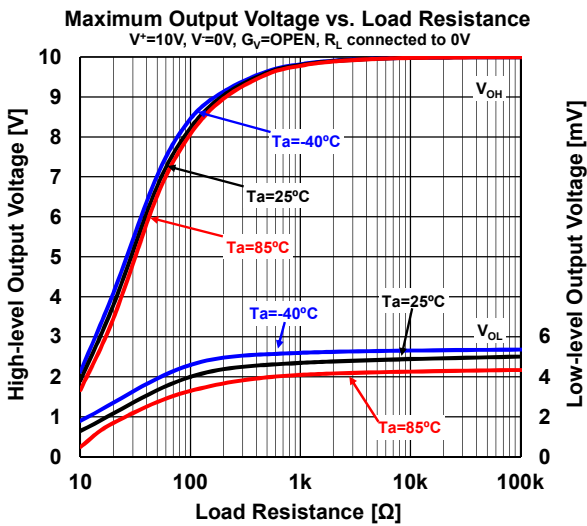
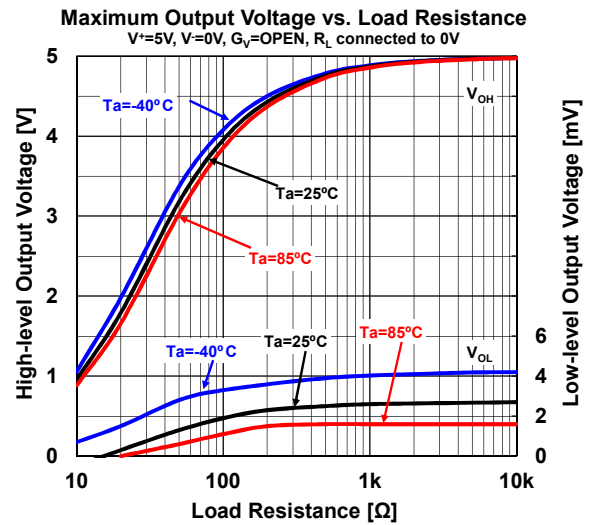
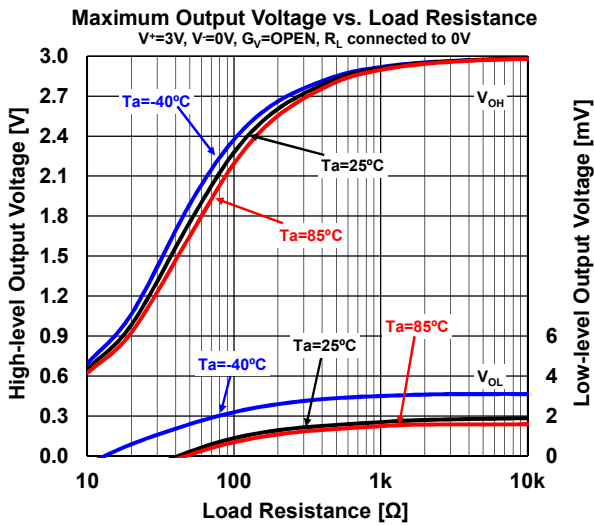

■ TYPICAL CHARACTERISTICS

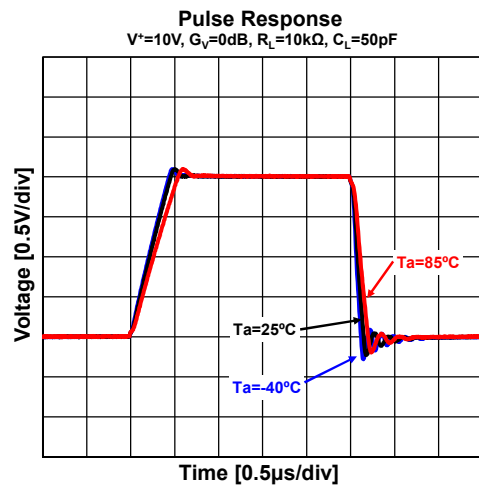
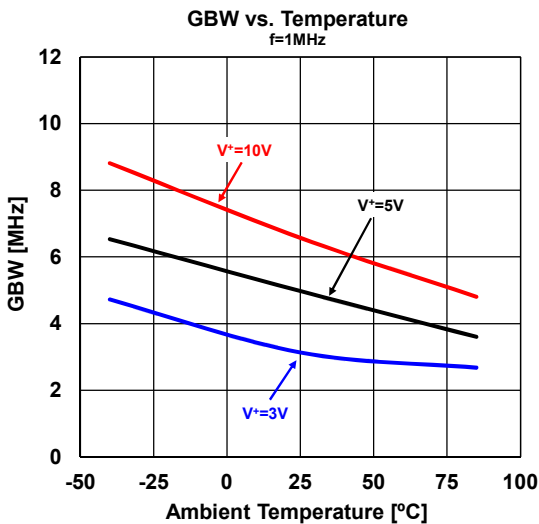
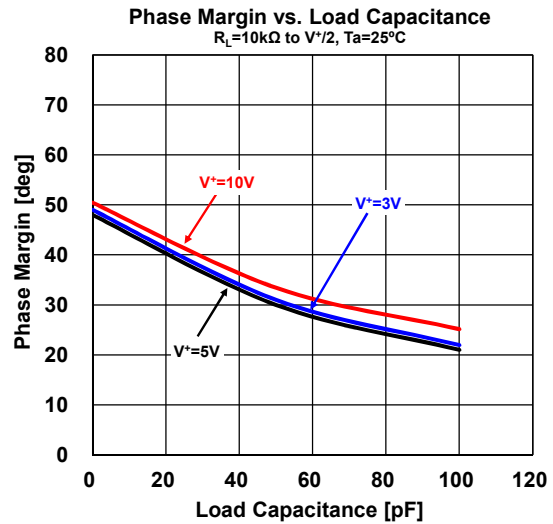
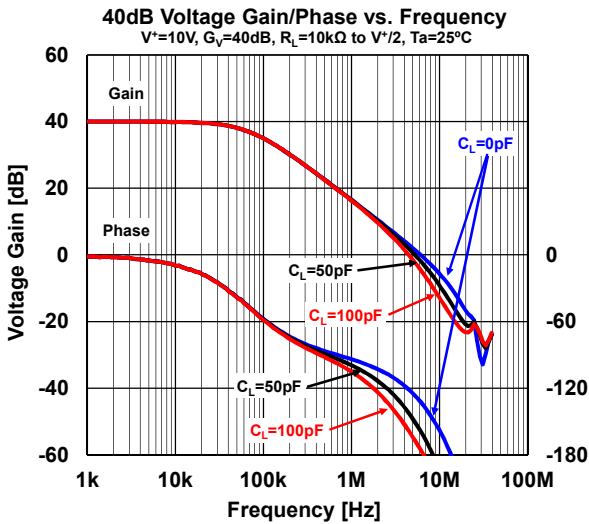
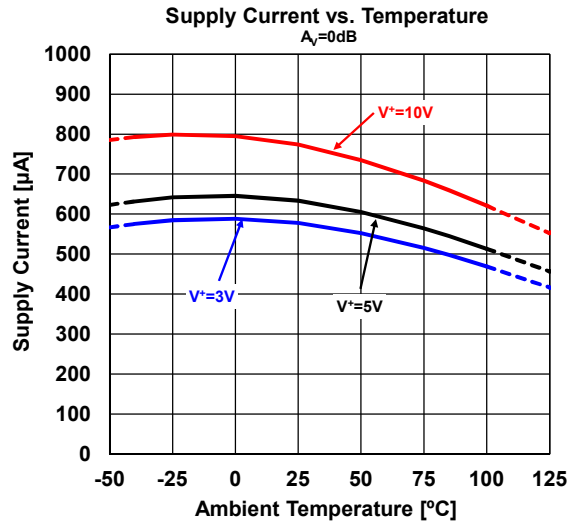
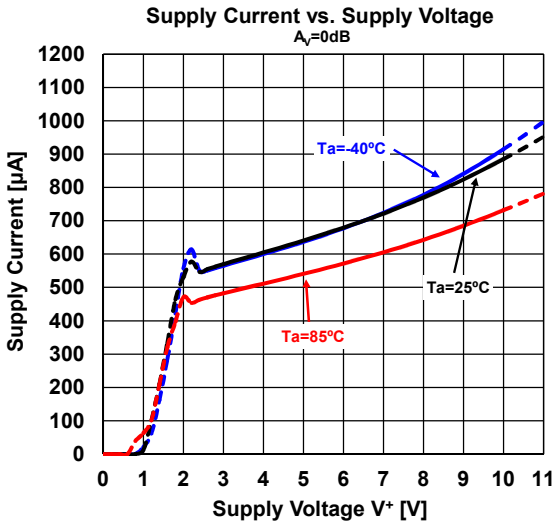

■ TYPICAL CHARACTERISTICS

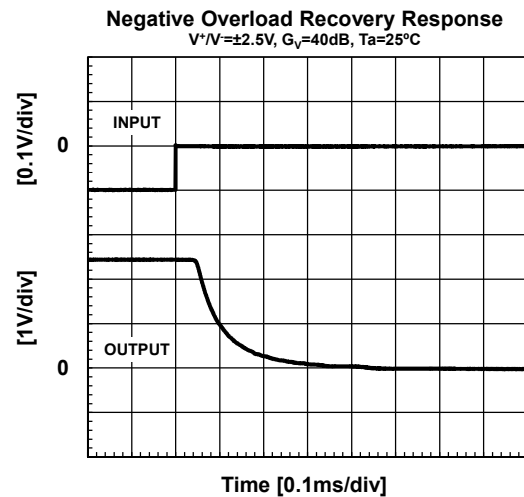
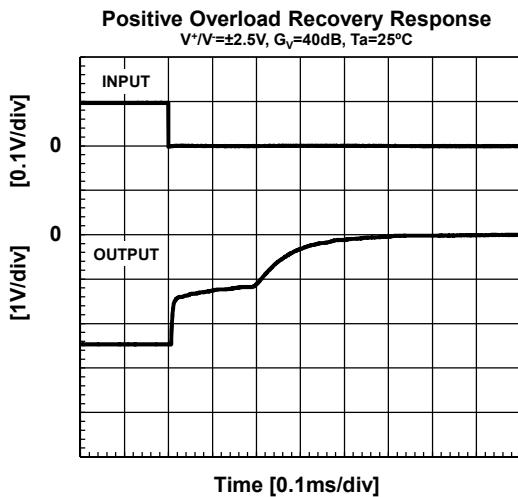
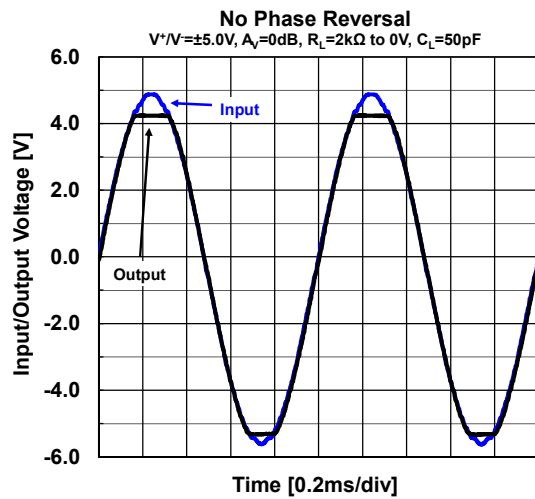
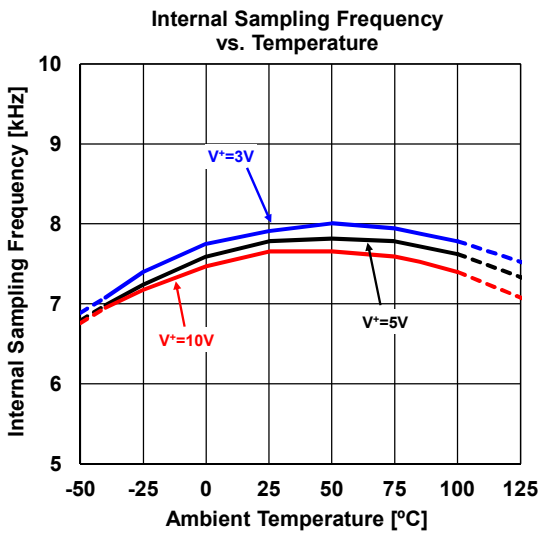
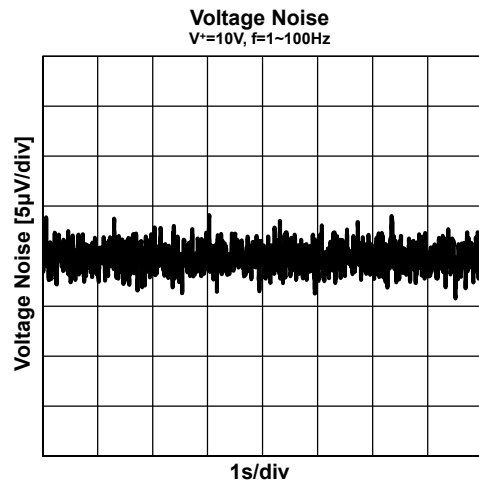
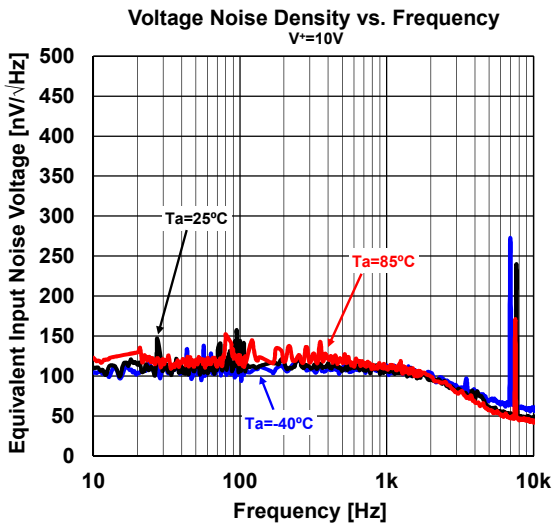

■ TYPICAL CHARACTERISTICS

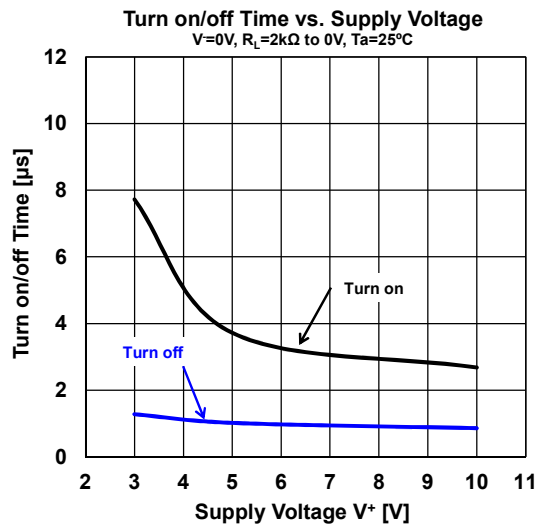
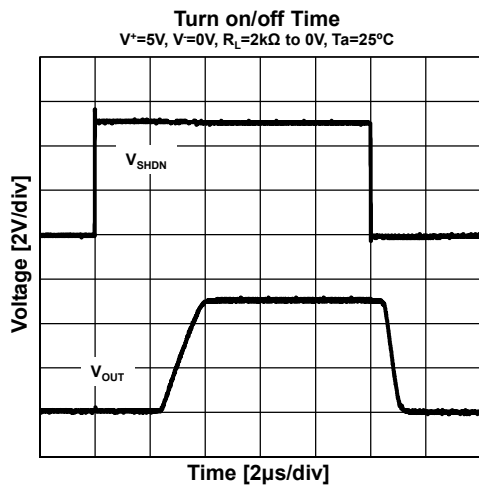
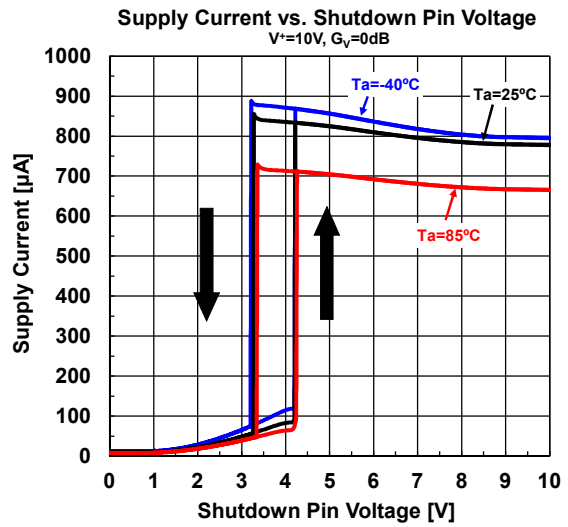
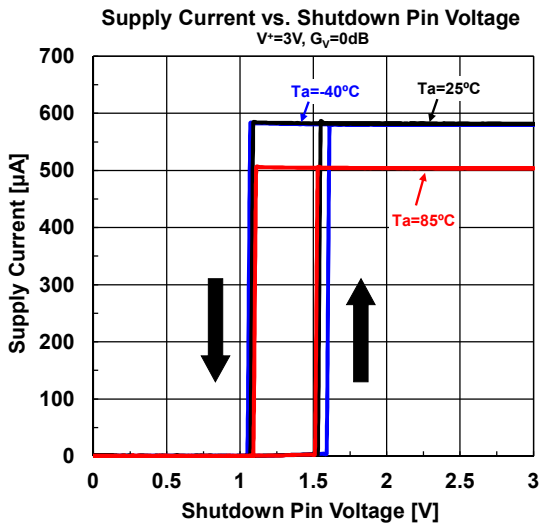

Application Note

Shutdown

The NJU7098A has a shutdown pin. It can be disabled when the shutdown pin voltage is pulled at less than 0.5V above the negative supply, it can be enabled when the shutdown pin voltage is pulled at $V^- - 0.5V$ or more above negative supply.

With the NJU7098A in shutdown mode, the output goes into high impedance mode. In this mode, the only path between the inputs and the output pin is through the external components around the device. So, for applications where there is active signal connection to the inverting input, with the NJU7098A in shutdown, the output could show signal swings due to current flow through these external components. For non-inverting amplifiers in shutdown, no output swings would occur, because of input-output isolation, with the exception of capacitive coupling.

In applications where shutdown operation is not needed and the NJU7098A is used, the shutdown pin should be open or connected to V^+ .

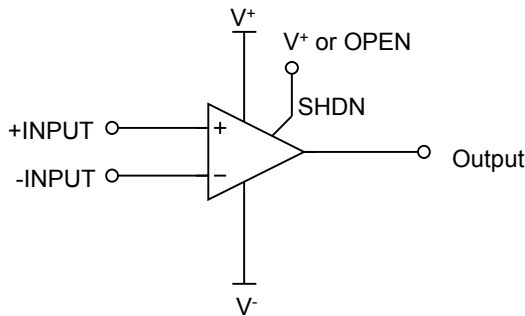

Normally Mode (Shutdown is disable)

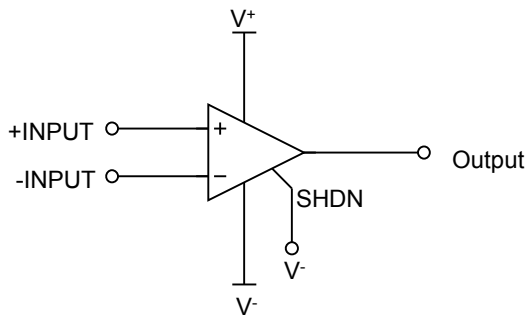

Shutdown Mode (Shutdown is enable)

Single and Dual Supply Voltage Operation

The NJU7098A works with both single supply and dual supply when the voltage supplied is between V^+ and V^- . These amplifiers operate from single 3 to 10V supply and dual $\pm 1.5V$ to $\pm 5V$ supply.

Common-Mode Input Voltage Range

When the supply voltage does not meet the condition of electrical characteristics, the range of common-mode input voltage is as follows:

$$V_{ICM} (typ.) = V^- \text{ to } V^+ - 1.5V \text{ (Ta = 25}^\circ\text{C)}$$

Difference of V_{ICM} when Temperature change, refer to typical characteristic graph. During designing, consider variations in characteristics for use with allowance.

Maximum Output Voltage Range

When the supply voltage does not meet the condition of electrical characteristics, the range of the typ. value of the maximum output voltage is as follows:

$$V_{OM} (typ.) = V^- + 5mV \text{ to } V^+ - 20mV \text{ (RL=10k}\Omega \text{ to } V^-, \text{ Ta=25}^\circ\text{C)}$$

During designing, consider variations in characteristics and temperature characteristics for use with allowance. In addition, also note that the output voltage range becomes narrow as shown in typical characteristics graph when an output current increases.

Thermoelectric Effect

The NJU7098A has a low offset voltage (15 μ V) and zero-drift (0.05 μ V/ $^\circ$ C) characteristics. Achieve a high performance, take care about thermoelectric effect possibly occurs on each input terminal. Generally, if there are thermal mismatches at the junction of different types of metals, the thermoelectric voltage (Seebeck effect) occurs at the junction. This voltage difference causes offset voltage and offset voltage drift. To minimize this voltage difference, the thermal mismatch in-between each input terminal and PCB metal should be minimized.

Input Bias Current

The NJU7098A has MOS input stage, and has very low bias current is 20pA at $V^+ = 5V$, $T_a = 25^\circ\text{C}$. But, as device temperature rises above approximately 100°C , the reverse leakage current of the input protection diodes becomes increasing, and input bias current rises rapidly with temperature (bias currents approximately double per 10°C increase).

For detail of bias current with temperature, see typical characteristics "Input bias current vs. temperature".

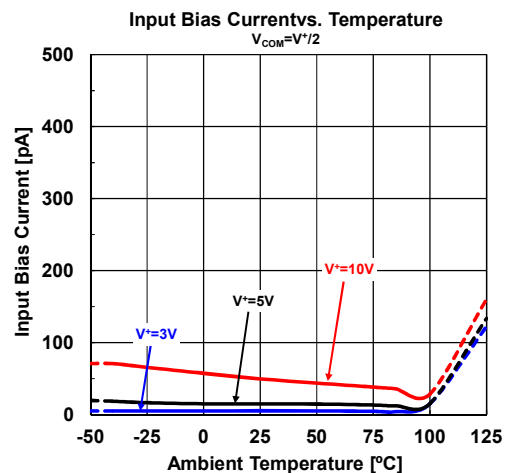

■ PACKAGE DIMENSIONS

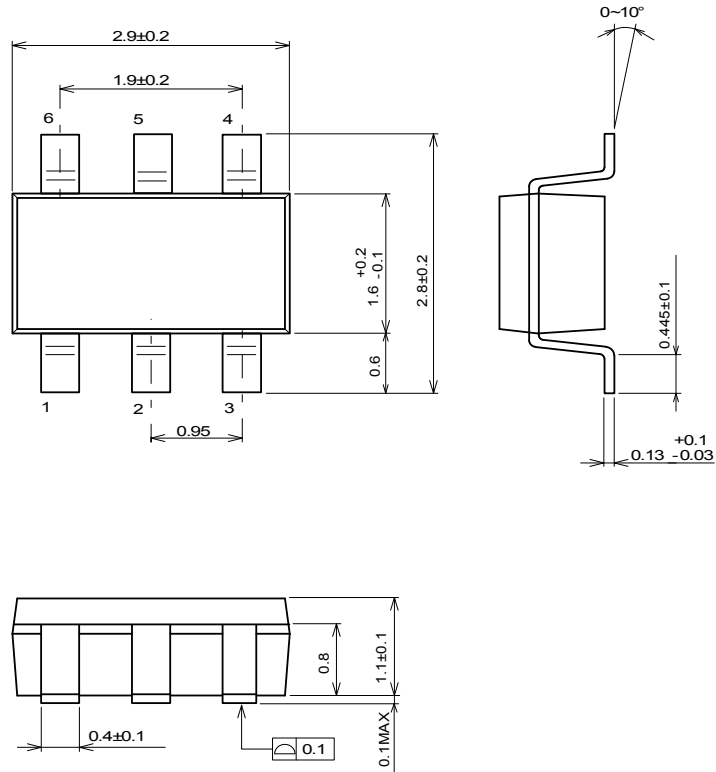

Unit: mm

SOT-23-6-1 Package

[CAUTION]
 The specifications on this databook are only given for information, without any guarantee as regards either mistakes or omissions. The application circuits in this databook are described only to show representative usages of the product and not intended for the guarantee or permission of any right including the industrial rights.