

OUTPUT COUPLING CAPACITOR-LESS VIDEO AMPLIFIER WITH COAXIAL COMMUNICATION RECEIVER

■ GENERAL DESCRIPTION

The NJU71041 is a Low Voltage Video Amplifier with Coaxial Communication Receiver. By the internal charge pump circuit, output capacitor is unnecessary.

The NJU71041 features low power and small package, and is suitable for low power design on downsizing of portable video system and system with video output.

■ PACKAGE OUTLINE



NJU71041RB2
MSOP10(TVSP10)

■ FEATURES

- Operating Voltage 2.5 to 3.45V
- Output coupling capacitor-less
- Coaxial Communication Receiver
- 6dB amplifier
- Internal 75Ω Driver Circuit (2-system drive)
- Internal LPF -1dB at 10MHz typ
 -40dB at 54MHz typ
- CMOS Technology
- Package Outline MSOP10(TVSP10)*
 *MEET JEDEC MO-187-DA / THIN TYPE

■ PIN CONFIGURATION

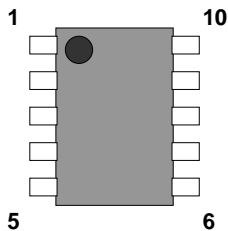

NJU71041RB2

- 1: CP1
- 2: V+
- 3: VIN
- 4: UTCREF
- 5: UTCOUT
- 6: UTCIN
- 7: VOUT
- 8: GND
- 9: V-
- 10: CP2

■ BLOCK DIAGRAM

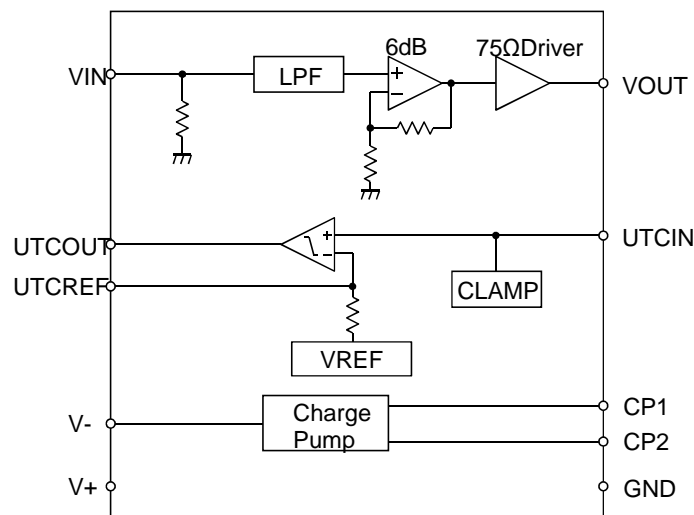

NJU71041

■ ABSOLUTE MAXIMUM RATINGS (Ta=25°C)

PARAMETER	SYMBOL	RATINGS	UNIT
Supply Voltage	V ⁺	3.55	V
Power Dissipation	P _D	MSOP10(TVSP10): 480(Note1)	mW
VIN Input Voltage (positive)	VIN+	+1.0	V
VIN Input Voltage (negative)	VIN-	-1.0	V
Operating Temperature Range	Topr	-40 to +85	°C
Storage Temperature Range	Tstg	-55 to +125	°C

(Note 1) At on a board of EIA/JEDEC specification. (114.3 x 76.2 x 1.6mm 2 layers, FR-4)

■ RECOMMENDED OPERATING CONDITION (Ta=25°C)

PARAMETER	SYMBOL	TEST CONDITION	MIN.	TYP.	MAX.	UNIT
Operating Voltage	Vopr		2.5	-	3.45	V

■ ELECTRICAL CHARACTERISTICS (V⁺=3.0V, R_L=150Ω, Ta=25°C)

PARAMETER	SYMBOL	TEST CONDITION	MIN.	TYP.	MAX.	UNIT
-----------	--------	----------------	------	------	------	------

◆ Power Supply

Operating Current	I _{CC}	No Signal	-	16	25	mA
-------------------	-----------------	-----------	---	----	----	----

◆ Video Amplifier Characteristics

Maximum Output Voltage Swing	V _{om}	f=100kHz, THD=1%	3.6	-	-	V _{p-p}
Voltage Gain	G _v	V _{in} =100kHz, 1.0V _{p-p} , Input Sine Signal	5.6	6.0	6.4	dB
Low Pass Filter Characteristic	G _{f9M}	V _{in} =6.75MHz/100kHz, 1.0V _{p-p}	-1.0	0	1.0	dB
	G _{f10M}	V _{in} =10MHz/100kHz, 1.0V _{p-p}	-	-1.0	-	
	G _{f54M}	V _{in} =54MHz/100kHz, 1.0V _{p-p}	-	-40	-24	
Differential Gain	DG	V _{in} =1.0V _{p-p} , 10step Video Signal	-	0.8	-	%
Differential Phase	DP	V _{in} =1.0V _{p-p} , 10step Video Signal	-	0.5	-	deg
S/N Ratio	SN _v	100kHz to 6MHz, V _{in} =1.0V _{p-p} 100% White Video Signal, R _L =75Ω	-	+70	-	dB
Switching Noise Level	N _{swpl}	R _L =75Ω, 10% White Video Signal Input	-	4	7	mV _{pp}

◆ Coaxial Communication Receiver Characteristics

Data Threshold Voltage	V _{th}		-	0.65	-	V
Data Output Voltage High Level	VOH		2.7	-	-	V
Data Output Voltage Low Level	VOL		-		0.3	

■ TEST CIRCUIT

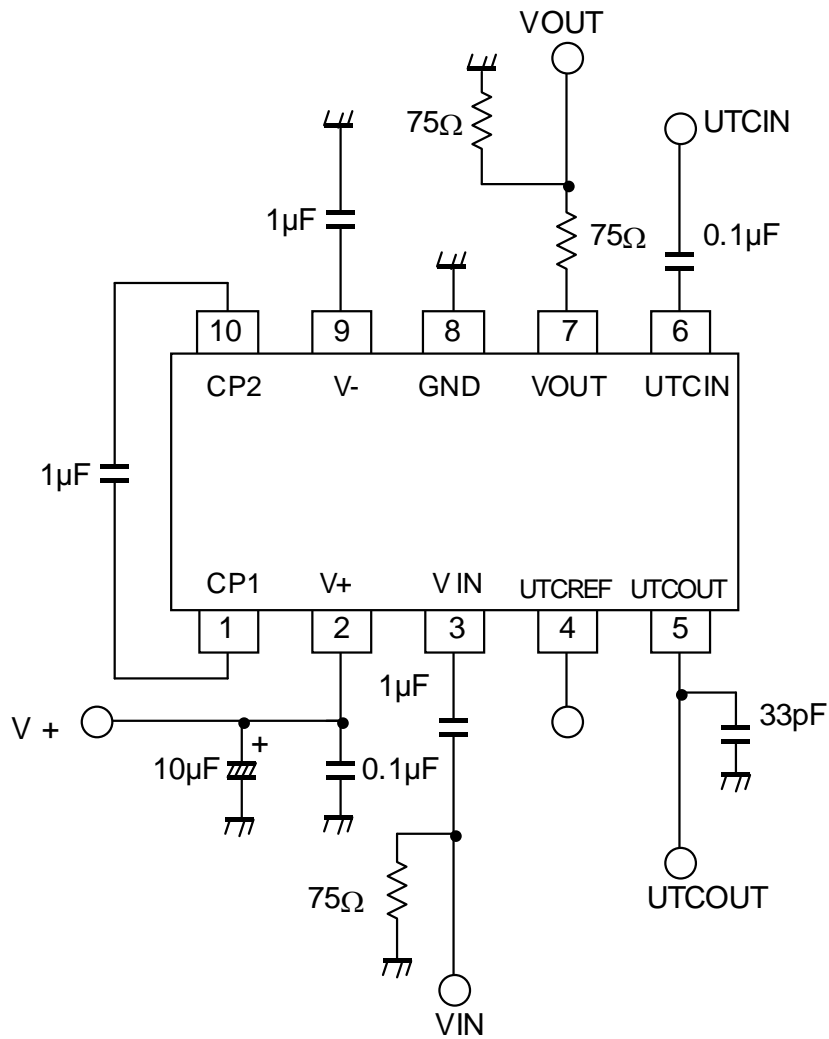

NJU71041

■ APPLICATION CIRCUIT 1 (Standard circuit)

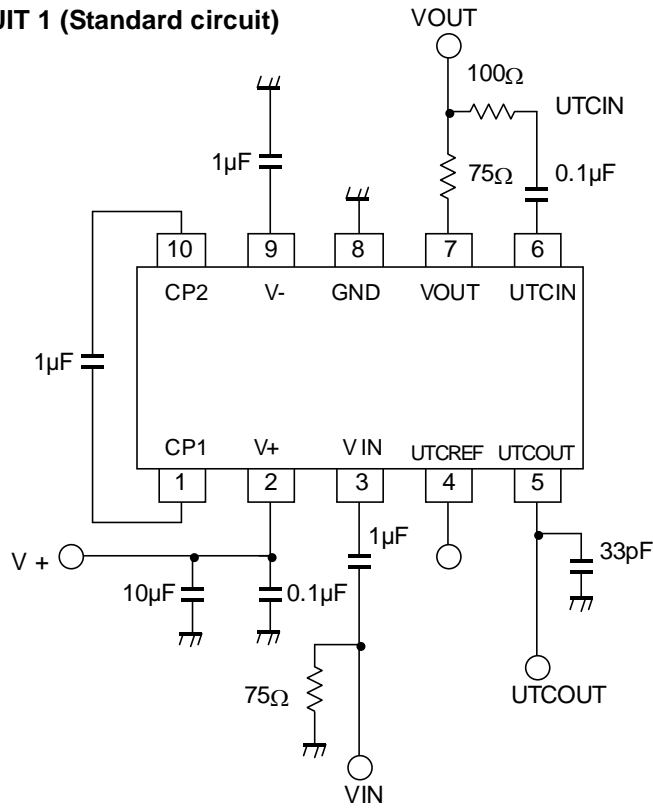

■ APPLICATION CIRCUIT 2 (Two-system drive circuit)

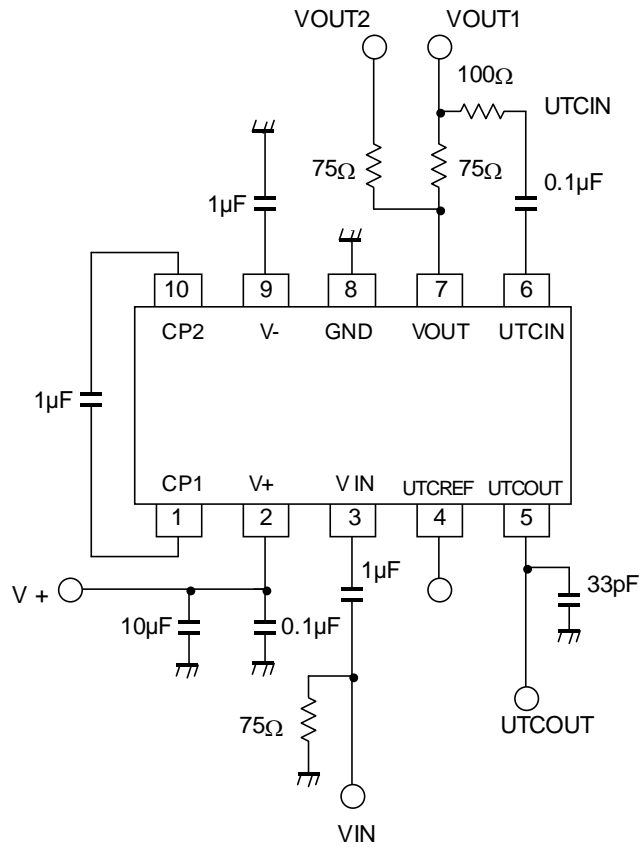

■ Application Note

• The UTC receiver block (UTCIN (pin6), UTCOUT (pin5), UTCREF (pin4))

The NJU71041 can transmit that video signal and camera control signal at one coaxial cable.

The output video signal from the NJU71041 superimposes on a camera control signal (a coaxial data from an output unit).

The output unit examples are DVR, camera-controller, and so on.

The superimposed signal is inputted to the NJU71041 UTCIN (pin 6). Refer to fig1.

The signal inputted to UTCIN (pin6) is compared to the reference voltage generated by the NJU71041.

After that, it is amplified and outputted the high (V+)/low (0V) signal from UTCOUT (pin5).

(The UTCREF (pin4) can set the threshold voltage of the comparator by the pull-down or the pull up resistor. Refer to fig3.)

The signal outputted from UTCOUT (pin5) is inputted to a camera control block of CCTV.

As above mentioned, the video signal and the camera control signal can transmit at one coaxial cable. Therefore, The NJU71041 contributes to the space - saving.

A case of multiple coaxial transmission: UTC(Up The Coaxial)

This is one of a case at the multiplex coaxial transmission used in CCTV.

It is a system that control signals of camera multiplexing to the coaxial cable.

This system is superimposed on the control signal pulse in the vertical blanking period as shown in Figure.

This is because do not affect the video signal.

Case of Coaxitron

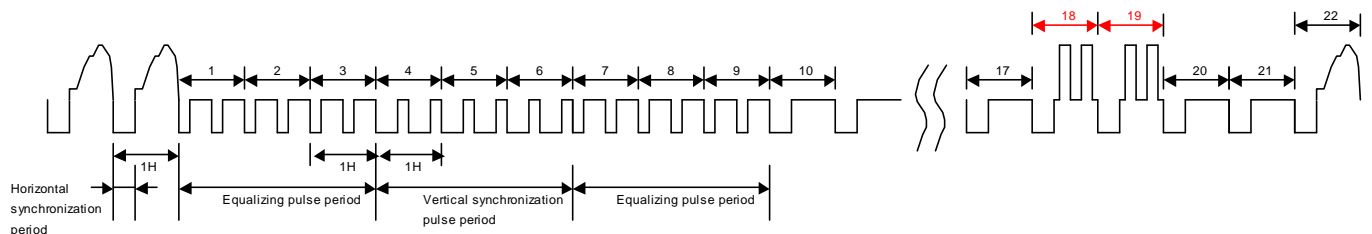

Figure: A case of UTC

• Application flow about the UTC receiver of the NJU71041

1. The output-signal from VOUT (pin7) superimposes a camera control signal by a camera control unit.
(The superimposed signal is inputted to the camera output block.)
2. The superimposed signal is inputted to UTCIN (pin6).
3. Its signal is clamped on sync-tip to reference voltage.
4. The clamped signal is amplified two times. After that, its signal is passed through comparator, and converted to high level (V+) or low level (0V). And then, the converted signal is outputted from UTCOUT (pin5).
5. The outputted signal from UTCOUT (pin5) is inputted to CCTV' s camera control unit.

Note) The control signal cannot use 2-system drive. Refer to Fig2.

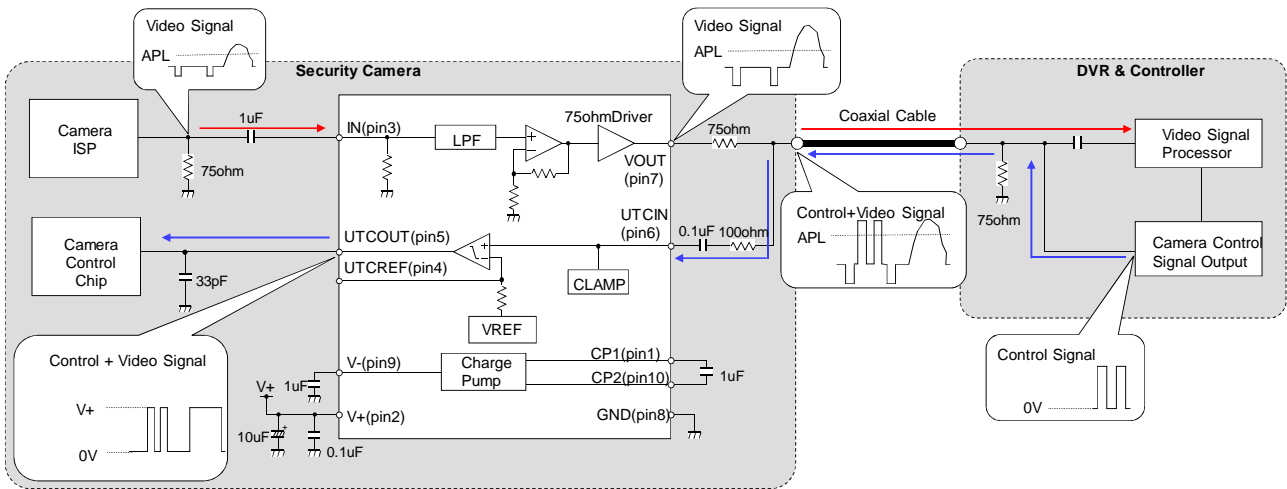

Fig.1: Application of UTC

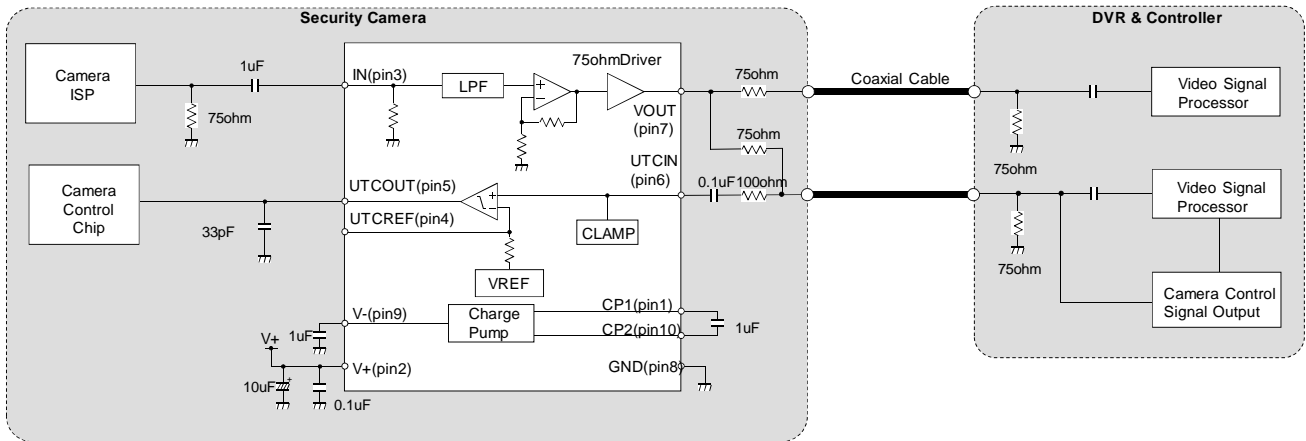

Fig.2: 2 - system drive application

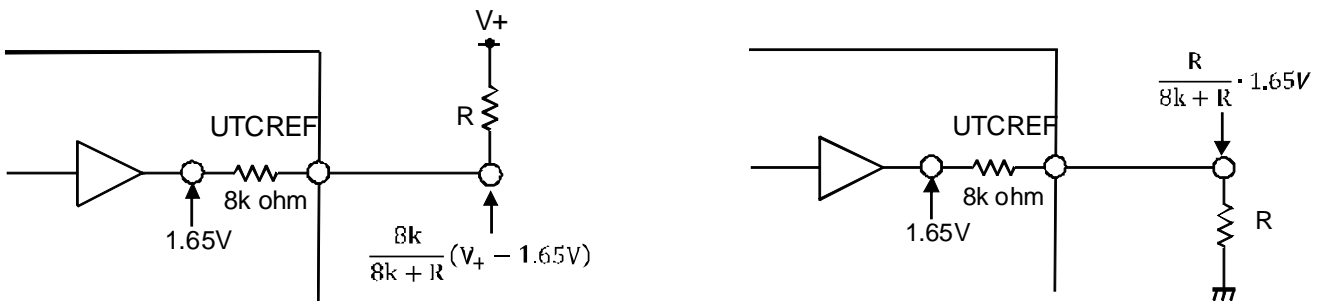
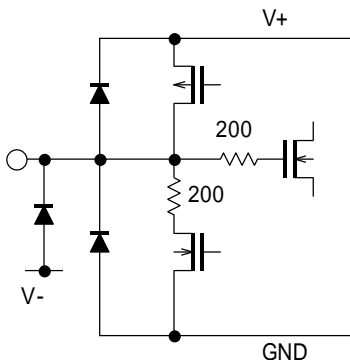
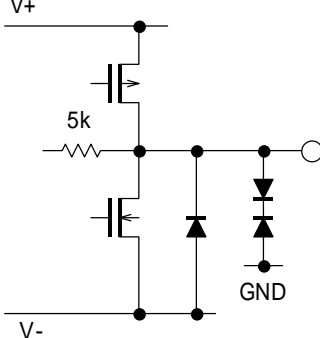
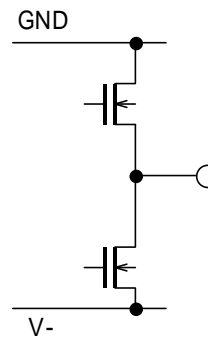

Fig.3: setting method (pull – up, pull – down resistor) of UTCREF

■ TERMINAL DIScription

PIN No.	PIN NAME	FUNCTION	EQUIVALENT CIRCUIT	DC VOLTAGE
1	CP1	Flying Capacitor Terminal		-
2	V+	V+ Power Supply	-	-
3	VIN	Input for video signal		0V
4	UTC REF	Adjust terminal for reference voltage of comparator (UTC receiver)		1.65V
5	UTC OUT	Output for UTC receiver		-

■ TERMINAL DISCRIPTION

PIN No.	PIN NAME	FUNCTION	EQUIVALENT CIRCUIT	DC VOLTAGE
6	UTCIN	Input for UTC receiver		0.35V
7	VOUT	Output for video signal		0V
8	GND	ground	-	-
9	V-	V- power supply for charge-pump	-	-
10	CP2	Flying Capacitor Terminal		-

■ TYPICAL CHARACTERISTICS

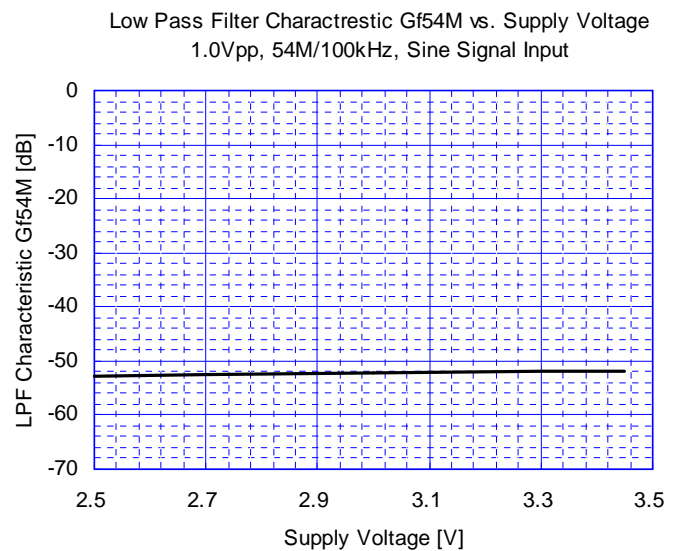
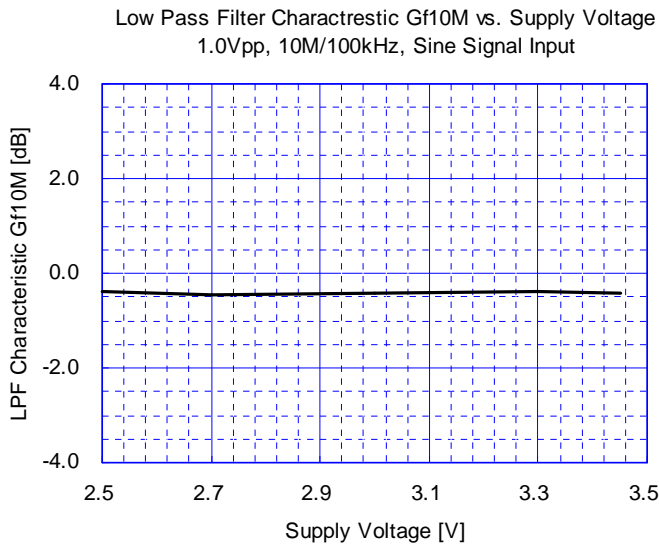
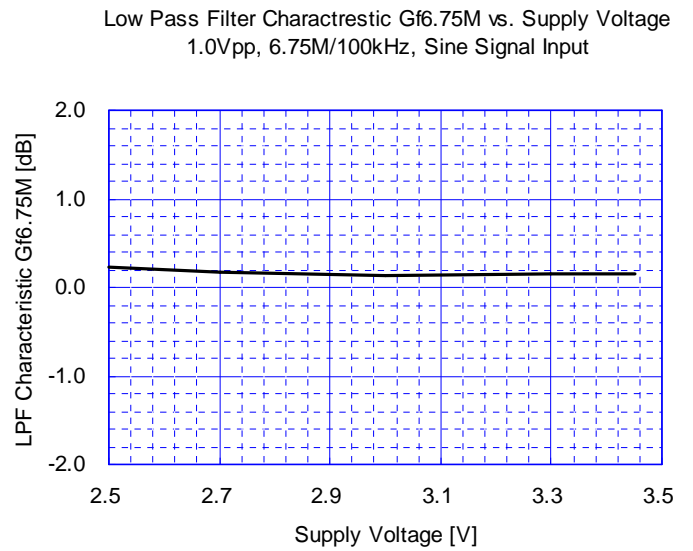
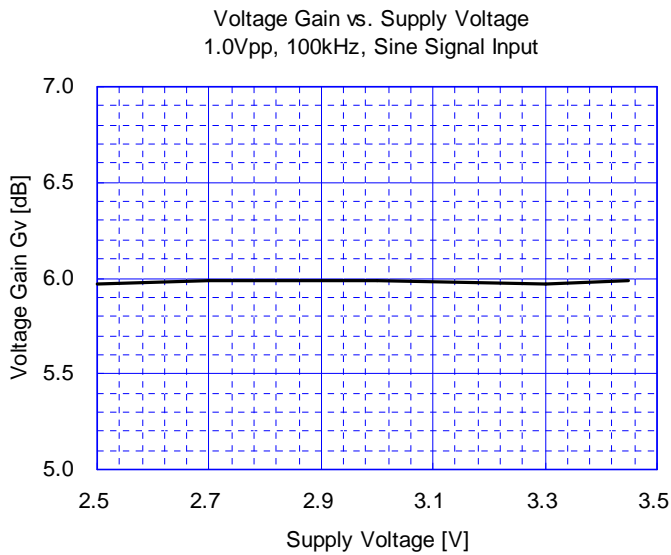
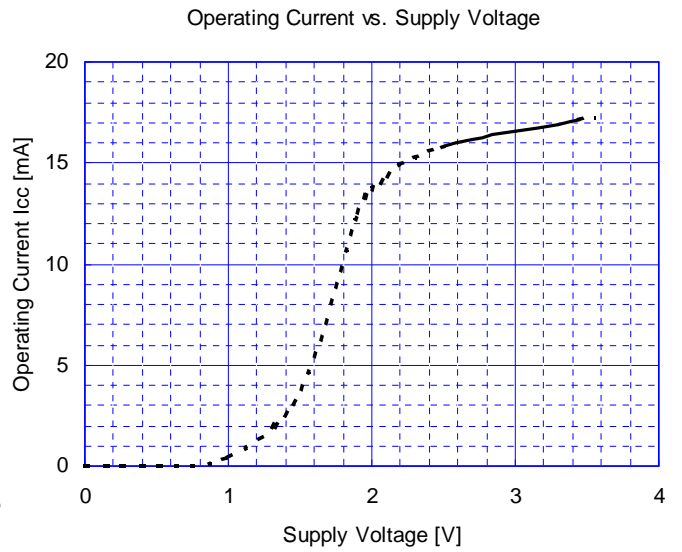
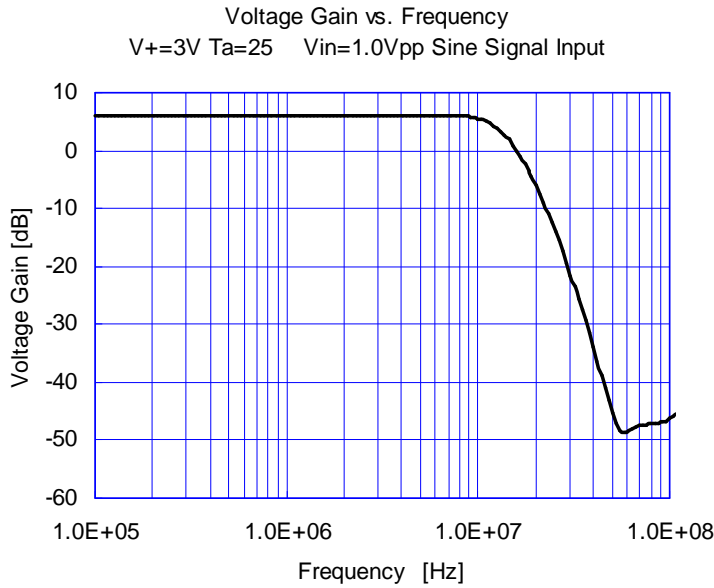

■ TYPICAL CHARACTERISTICS

Differential Gain vs. Supply Voltage
1.0Vpp, 10step video signal input

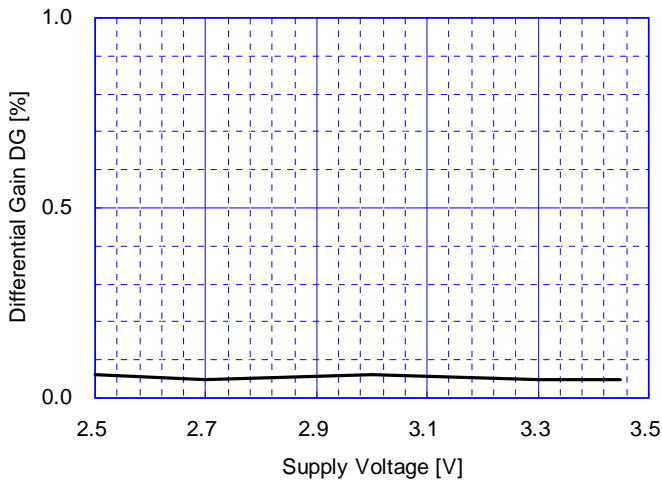

Differential Phase vs. Supply Voltage
1.0Vpp, 10step video signal input

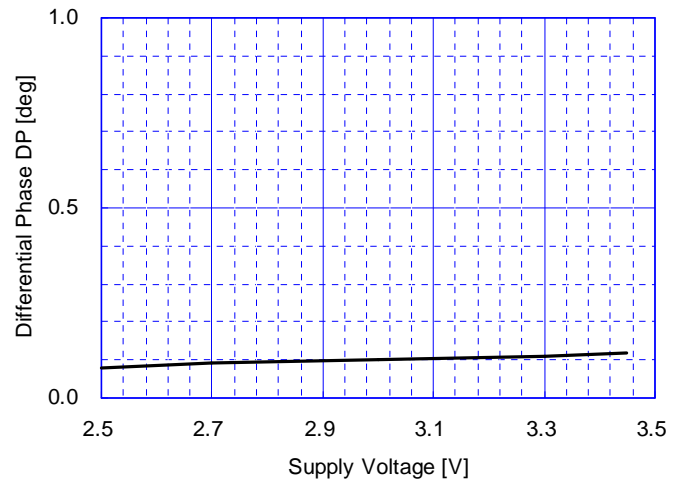

Signal to Noise Ratio vs. Supply Voltage
1.0Vpp, 100% white video signal input

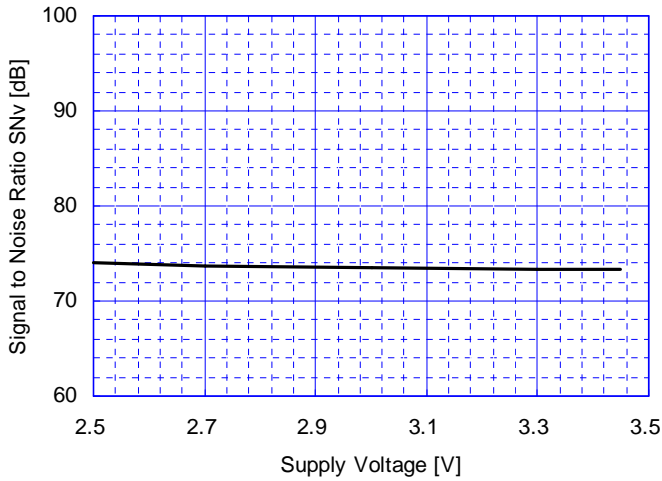

Switching Noise Level vs. Supply Voltage

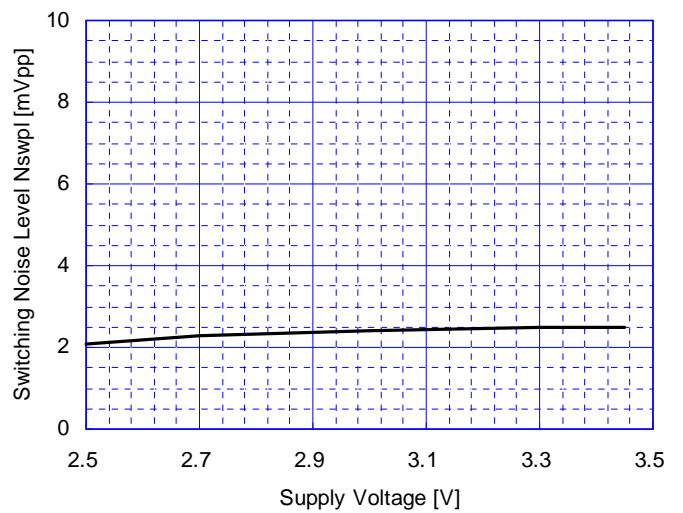

Total Harmonic Distortion vs. Supply Voltage
VOUT=4Vpp 100kHz Sinw ave

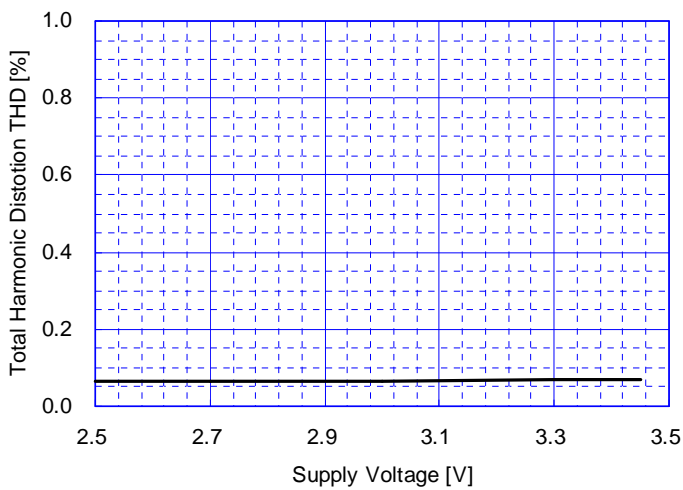

■ TYPICAL CHARACTERISTICS

Data Threshold Voltage vs. Supply Voltage
UTCIN Low Level to High Level

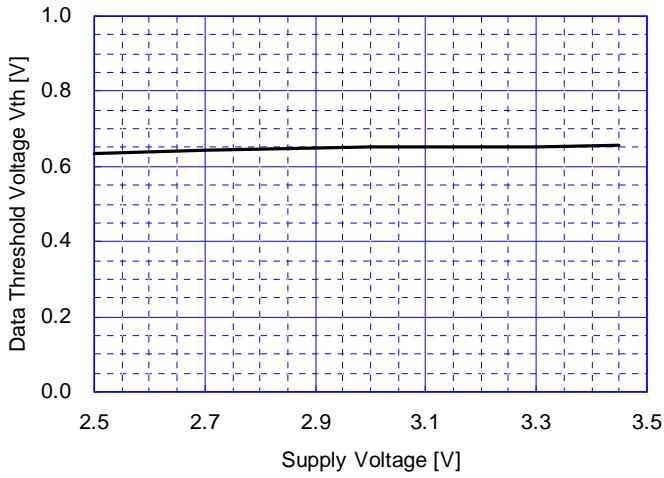

Data Threshold Voltage vs. Supply Voltage
UTCIN High Level to Low Level

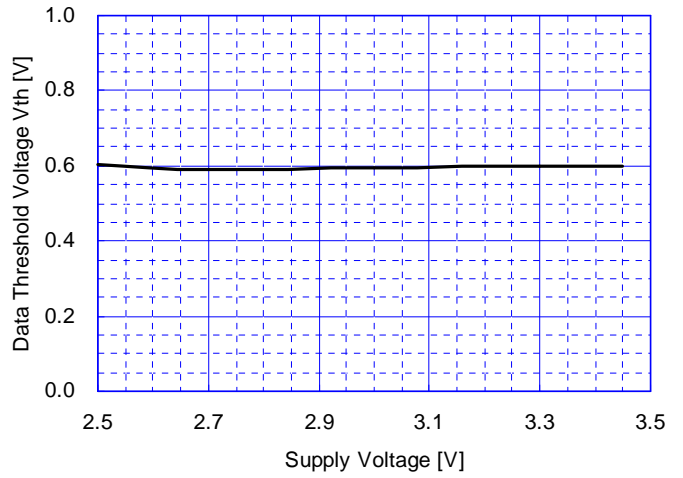

Data Output Voltage High Level vs. Supply Voltage

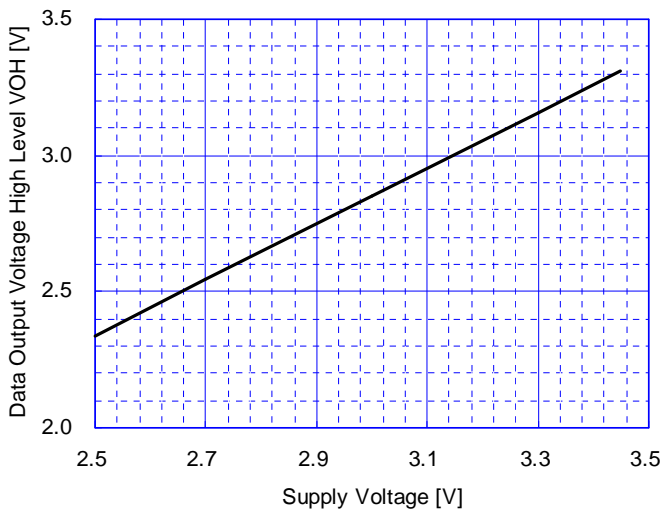

Data Output Voltage Low Level vs. Supply Voltage

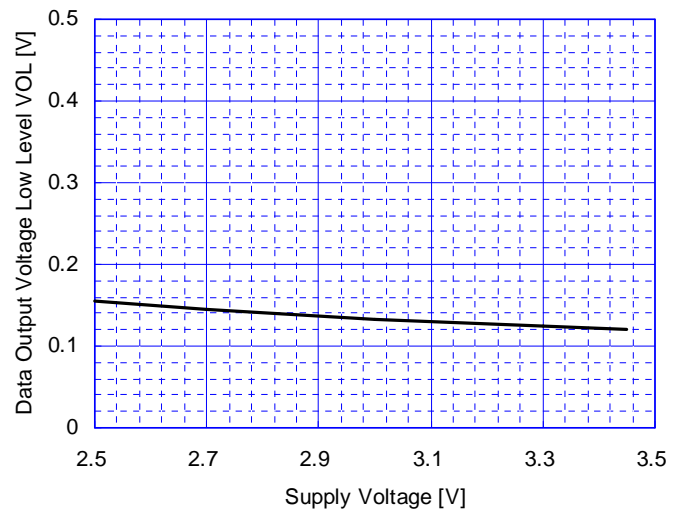

Data Threshold Voltage vs. UTCREF Resistance
UTCIN Low Level to High Level

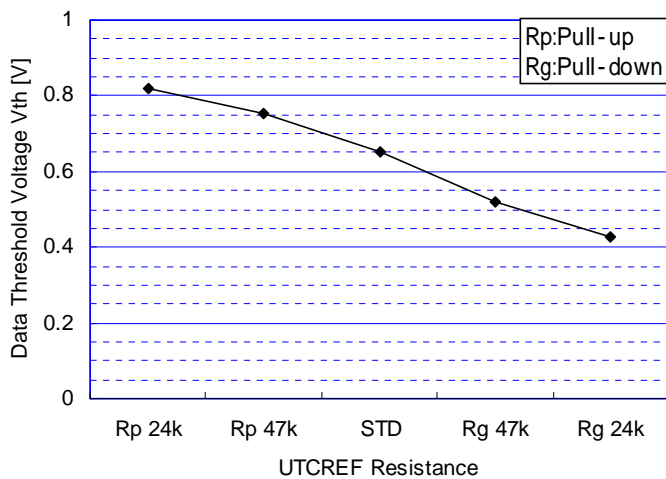

Data Threshold Voltage vs. UTCREF Resistance
UTCIN High Level to Low Level

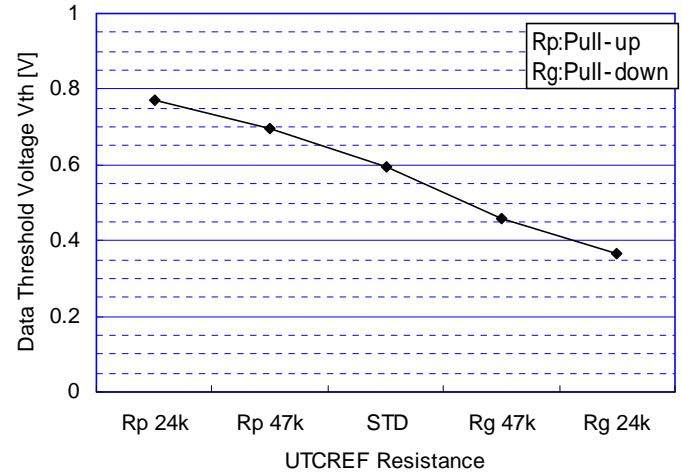

■ TYPICAL CHARACTERISTICS

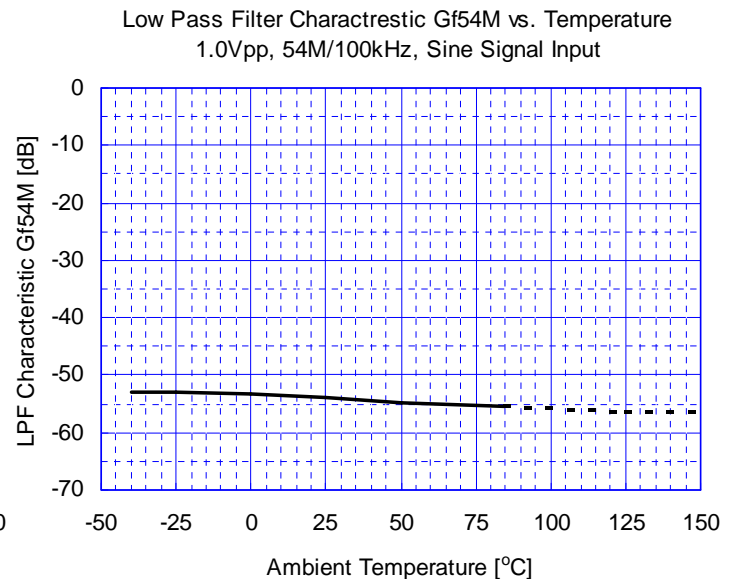
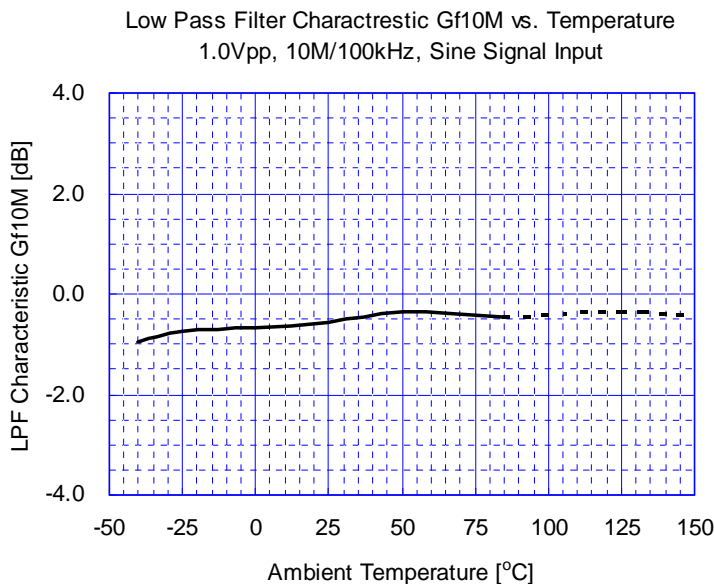
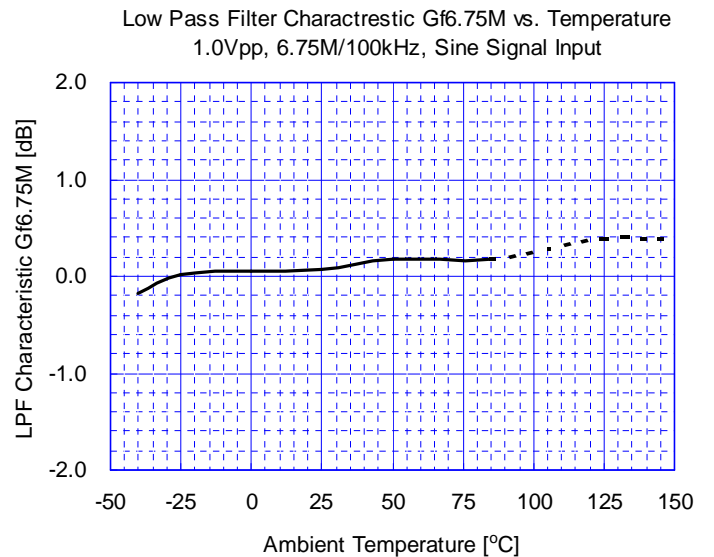
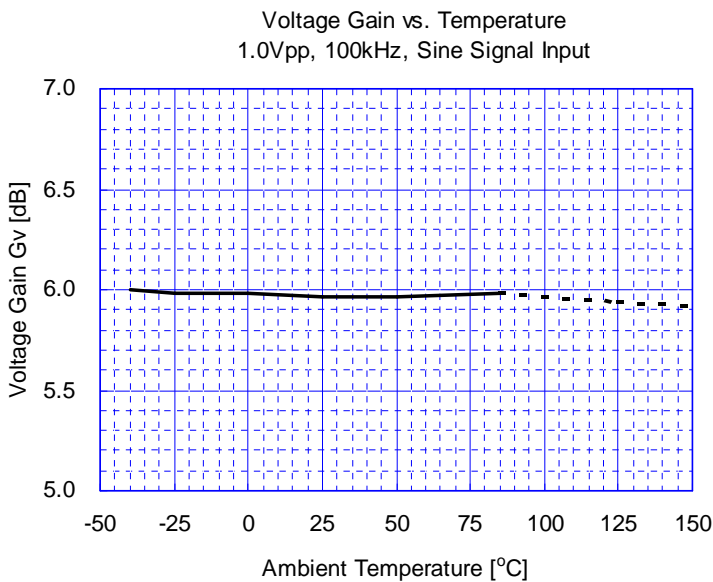
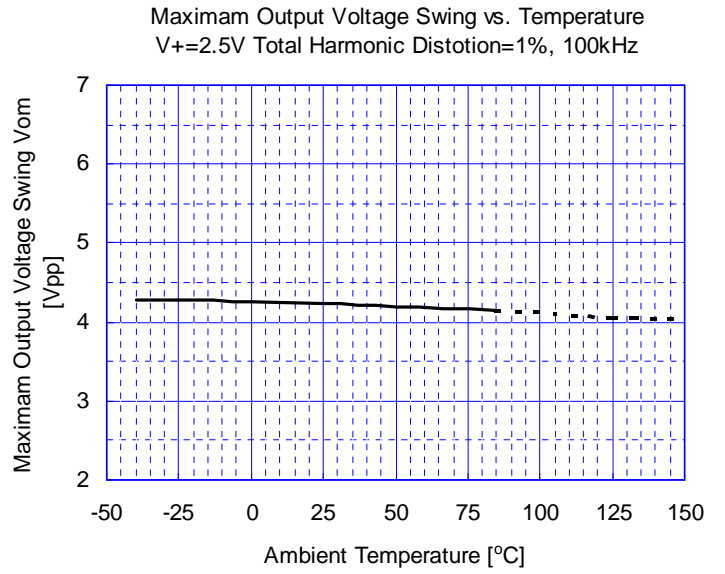
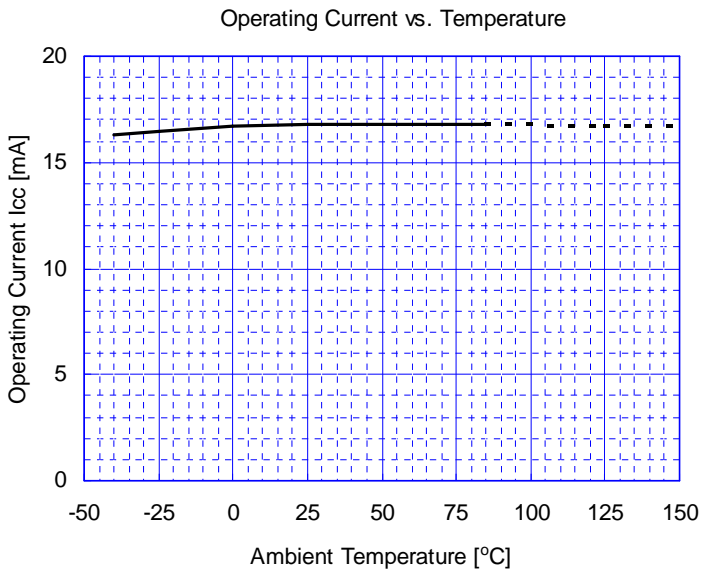

■ TYPICAL CHARACTERISTICS

Differential Gain vs. Temperature
1.0Vpp, 10step video signal input

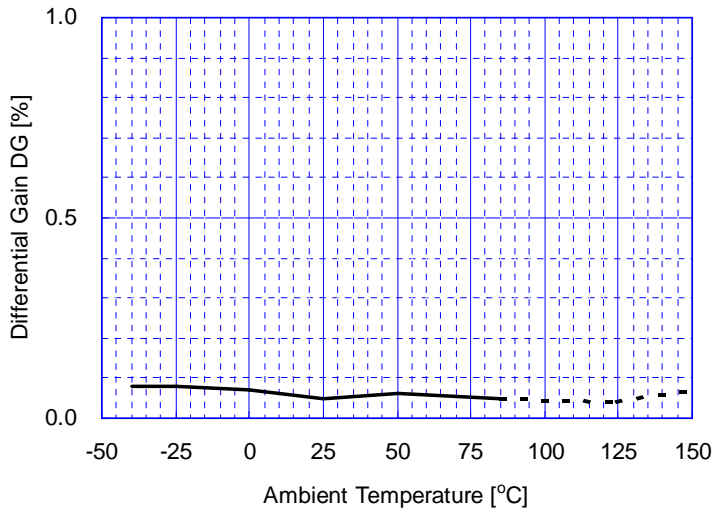

Differential Phase vs. Temperature
1.0Vpp, 10step video signal input

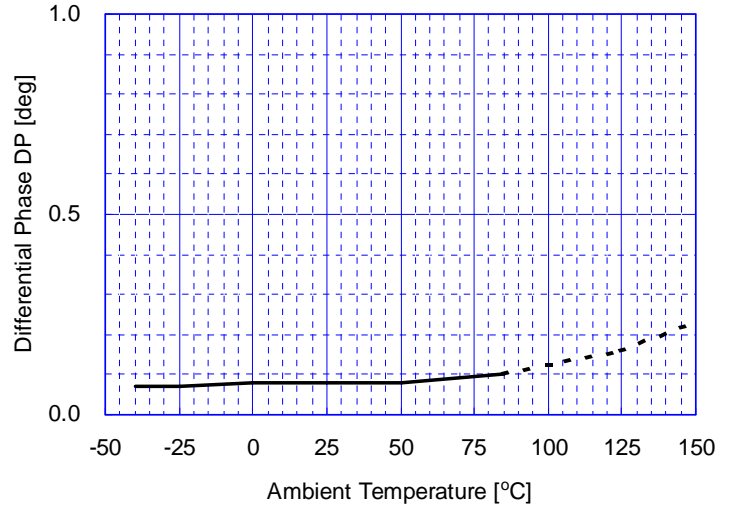

Signal to Noise Ratio vs. Temperature
1.0Vpp, 100% white video signal input

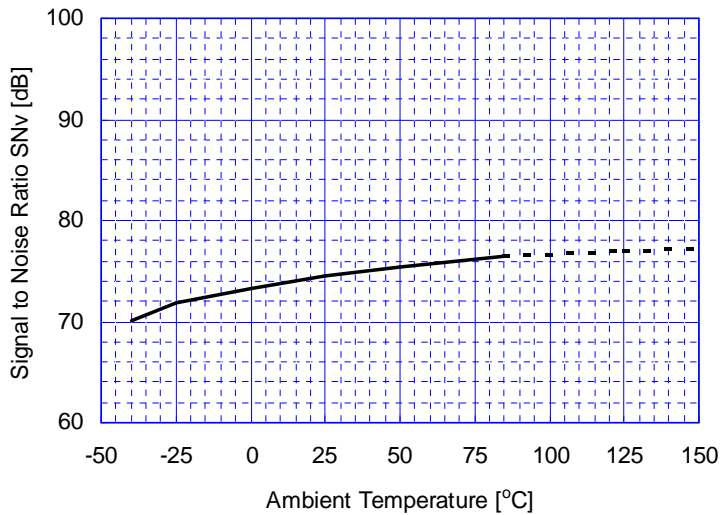

Switching Noise Level vs. Temperature

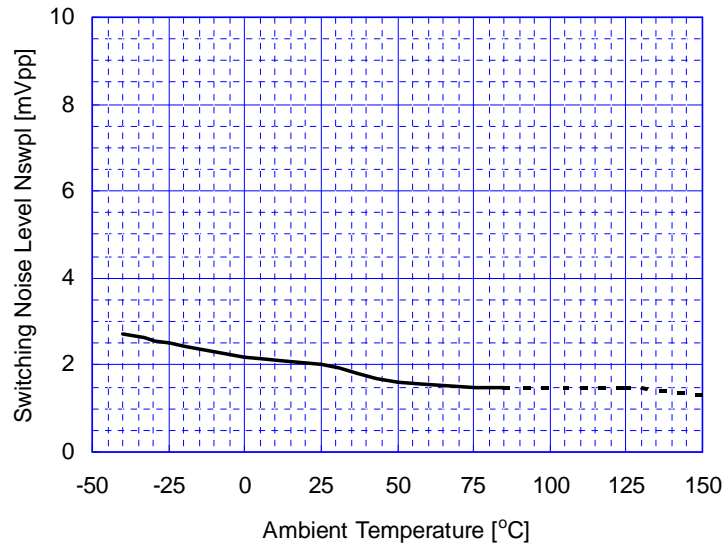

Data Threshold Voltage vs. Temperature
UTCIN Low Level to High Level

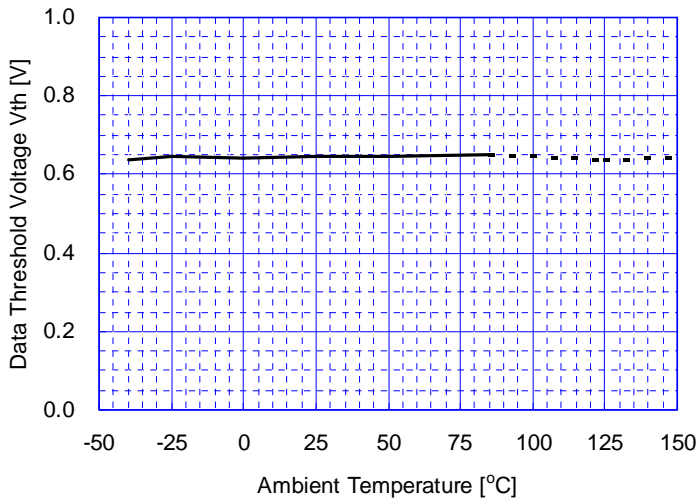

Data Threshold Voltage vs. Temperature
UTCIN High Level to Low Level

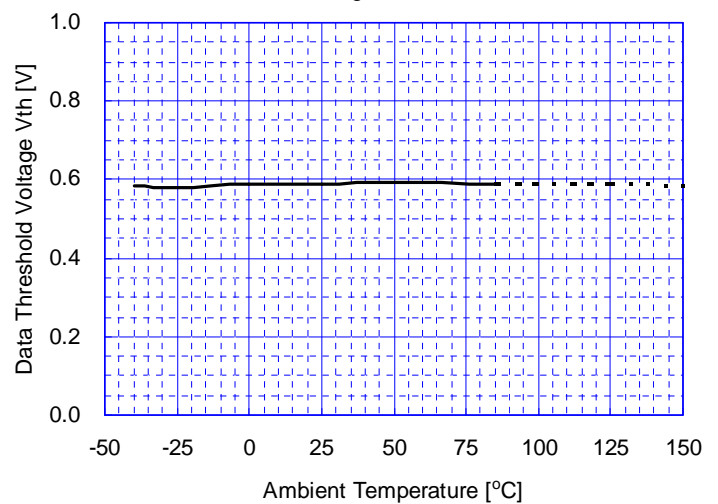

■ TYPICAL CHARACTERISTICS

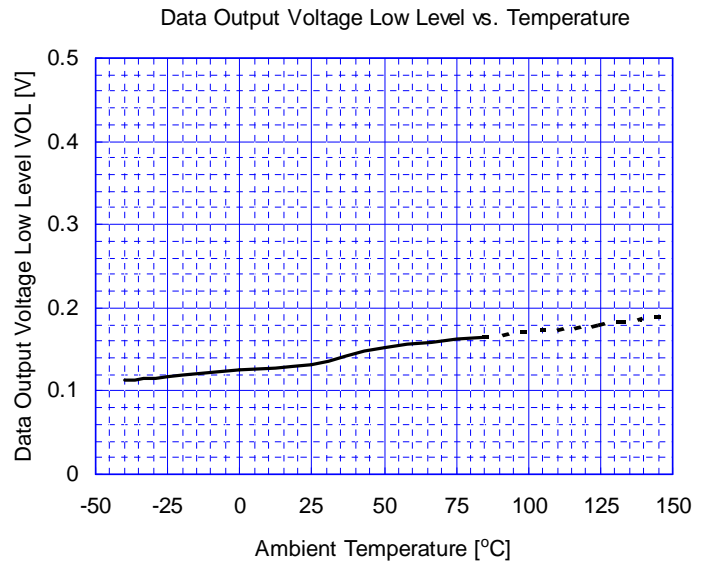
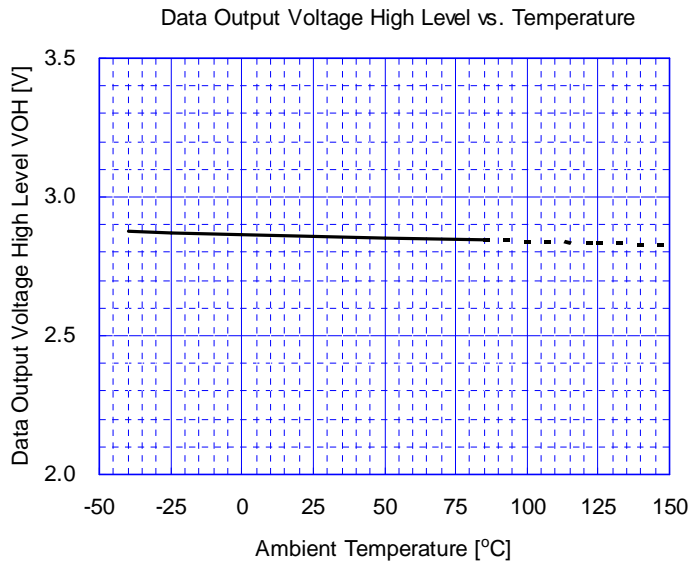

[CAUTION]

The specifications on this databook are only given for information, without any guarantee as regards either mistakes or omissions. The application circuits in this databook are described only to show representative usages of the product and not intended for the guarantee or permission of any right.